

**Bottom View of Assembly**

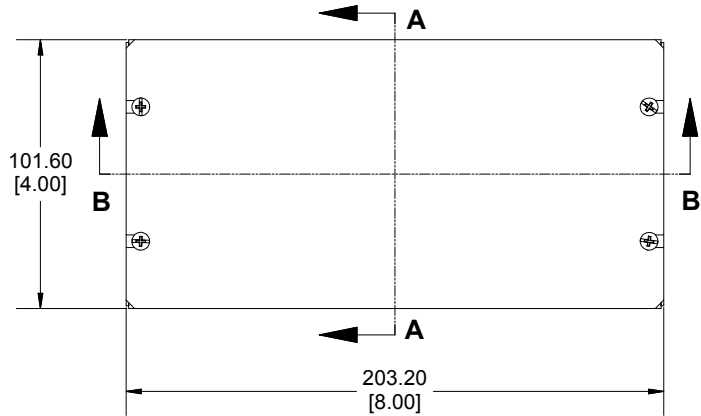

**SECTION A-A  
End View of Assembly**

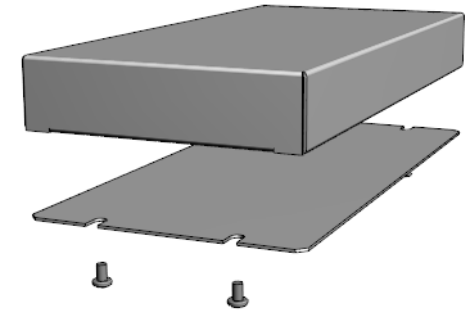
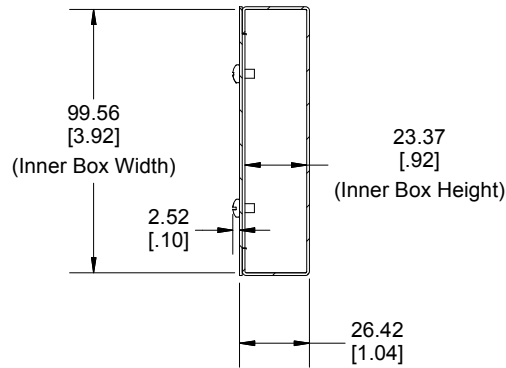

**SECTION B-B  
Side View of Assembly**

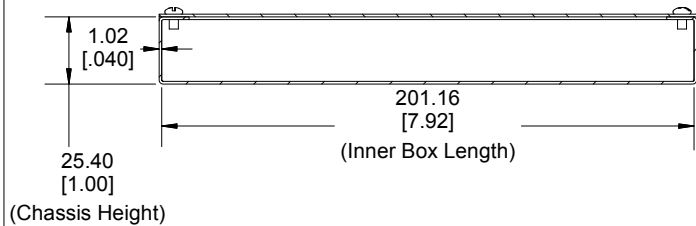

**Bottom View of Chassis  
(Sold Separately)**

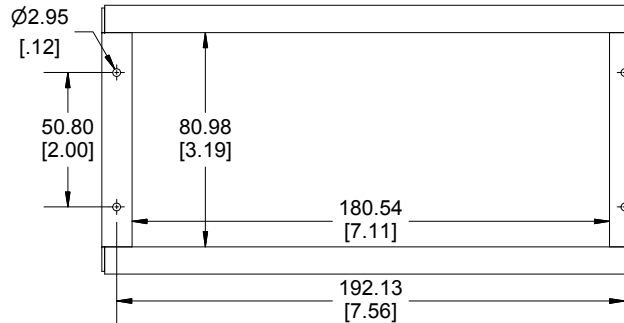

**Bottom Plate  
(Sold Separately)**

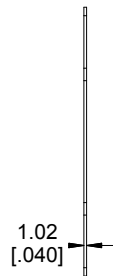
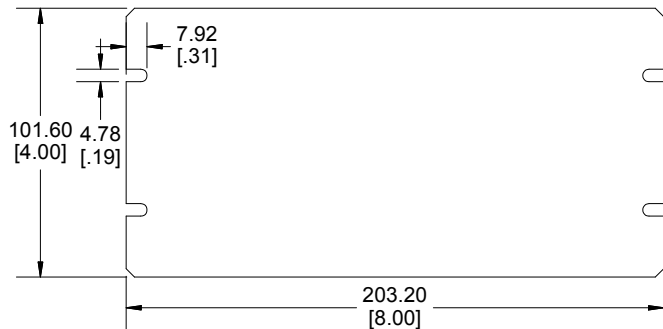

Enclosures can be Factory Modified ( Milling, Drilling, Printing etc.)  
Contact Factory [mjm@hammondmfg.com](mailto:mjm@hammondmfg.com) for quotes  
Solid models of this enclosure available in STEP or IGES.

**NOTE**

All Components Sold Separately  
Chassis is Made of 0.040" Aluminum.  
Bottom Plate is Made of 0.040" Aluminum.

**PART NUMBERS**

<b>1444-9 Enclosure</b>	
Natural Finish Chassis	1444-9
<b>ACCESSORIES</b>	
Natural Finish Bottom Plate	1434-10
Plated Cover Screws (Pkg 6) [6-32 x 1/4" Self-Tapping Screws]	1421J6

**HAMMOND  
MANUFACTURING™**  
**1444-9**  
www.hammondmfg.com

Dimensions:  
mm  
[inches]