



**HAMMOND
MANUFACTURING®**

www.hammondmfg.com

185E24

Low Voltage Chassis Mounted Power Transformer

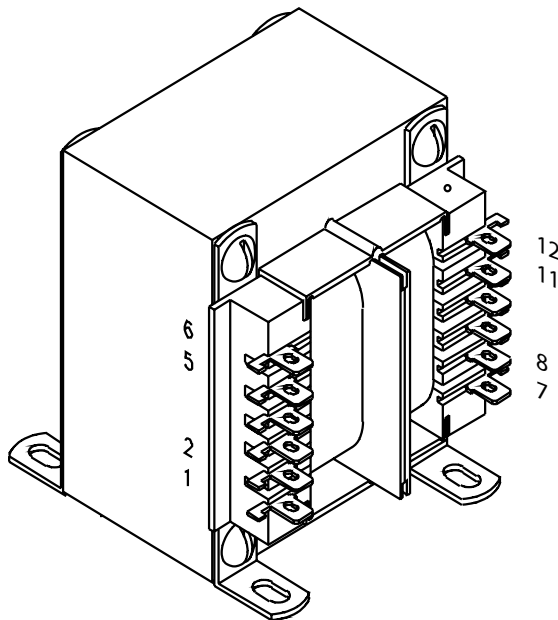

Key Features:

- Universal operation on 50/60Hz, 115/ 230V dual primary for worldwide use.
- Dual bobbin construction
- Dual use terminals (solder lug or quick connect)
- Dual secondaries for series or parallel connections
- 4,000V RMS Hipot tested
- Class F Insulation - 155 degrees C.
- Agency listings: cURus, CE, and TUV.

Overall Dimensions - in. (mm)	
Width	2.5 (63.5)
Depth	2.61 (66.3)
Height	3 (76.2)
Weight	2.5 lbs./ 1.1 kg.
Hole to Hole Mounting Dims. - in. (mm)	
Width	2 (50.8)
Depth	2.18 (55.4)
Terminal Lug Data- in. (mm)	
Width	0.25 (6.4)
Thickness	0.03 (0.8)
Electrical	
Size (VA)	80
Primary	115/ 230 VAC
Sec (Series)	24V C.T. @3.3A
Sec (Parallel)	12V@6.6A

Primary Connections - 185 Series Transformers

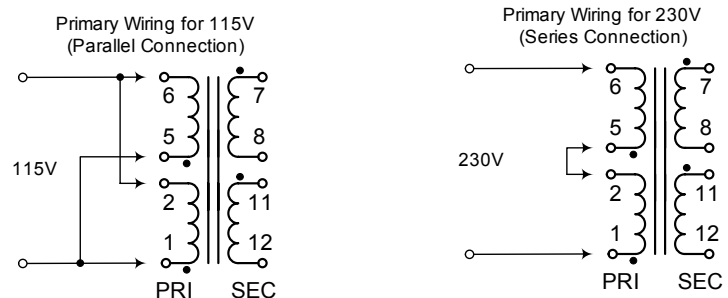

Secondary Connections - 185 Series Transformers

