

Accuphase

STEREO PHONO AMPLIFIER

C-47

- Low-noise fully balanced configuration
- One dedicated balanced MC phono input and three sets of regular phono inputs
- Separate settings memory for each input position
- Balanced and line level output connectors
- Polarity selector for balanced output
- Full mono construction
- Low-noise regulated power supply circuitry unaffected by load fluctuations
- High-accuracy phono equalizer with RIAA deviation of only ± 0.3 dB
- Load impedance settings for six MC and three MM phono cartridge types
- 7-segment LED indicator shows load impedance
- Gain selector for low-output phono cartridges
- Built-in subsonic filter



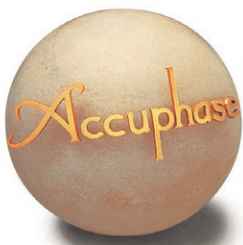

The Realization of a Dream — Fully Balanced Phono Equalizer Amp

The C-47 is the first phono amplifier of this series which realizes a fully balanced configuration from input to output. The resulting product not only is highly impervious to external noise, it also features a dedicated head amplifier optimized for the characteristics of MC and MM phono cartridges, and a high-accuracy equalizer amplifier, thereby ensuring precise equalization with a minimum of noise. A set of newly added dedicated balanced MC phono inputs enables balanced connection to the analog record player. By bringing out the full performance potential of each phono cartridge, the C-47 delivers a rich and deeply satisfying musical experience.

Innovation - At the leading edge of technology

Extremely low noise and highly accurate equalizer characteristics

The C-47 features a two-stage design with a low-noise head amplifier optimized to handle MC and MM cartridges and a high-accuracy equalizer amplifier dedicated to the task of equalizing the signal. By designing the low-noise head amp for high gain (MC: 50 dB, MM: 20 dB), the influence of any noise components in the subsequent equalizer amplifier is kept to a minimum, resulting in excellent low-noise performance combined with super-accurate equalization characteristics.

Fully balanced configuration

As a first in the series, the C-47 employs a fully balanced configuration which reliably shuts out external noise. The output signal from the cartridge is treated as a balanced signal, and the head amp performs balanced amplification (amplifying only the difference between two signal inputs). Balanced signal transmission is maintained also after the head amplifier, and full equalization is realized by making the equalizer amplifier a balanced type as well.

Full mono construction

For enhanced channel separation, it is crucial to keep the circuitry of one channel physically separate from the other. In the C-47, the head amp and equalizer amp are mounted on separate boards for the left and right channel, but the designers have gone one step further. The toroidal transformer, smoothing aluminum electrolytic capacitors, and regulated power supply circuitry are also duplicated for each channel, thereby realizing a fully monaural configuration.

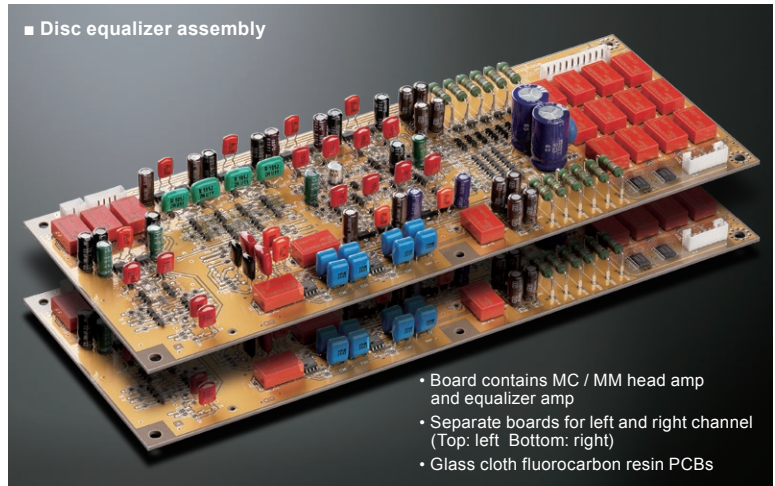
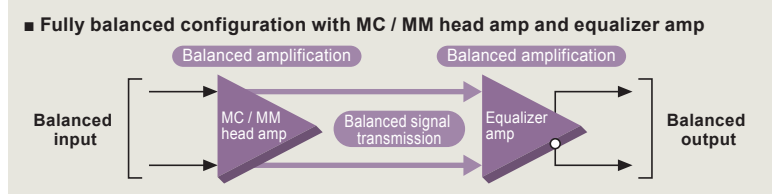

Sound quality - Simply aiming for the best

Low-noise regulated power supply circuitry unaffected by load fluctuations

In a phono equalizer amplifier that handles extremely weak signals, the quality of the power supply has a significant effect on sound quality. The smoothing circuitry employs four 25 V / 15,000 μ F aluminum electrolytic capacitors per channel, specially selected for their sonic properties. This generously dimensioned configuration virtually eliminates adverse effects from ripple currents and similar. The use of a regulated power supply circuit with very low noise voltage and excellent handling of load fluctuations further ensures that the power supply does not introduce any noise.

Dedicated balanced MC phono input

A dedicated balanced MC phono input makes it possible to handle the signal supplied by the cartridge as a balanced signal. A balanced phono cable can therefore be used for the connection between the analog record player and the C-47.

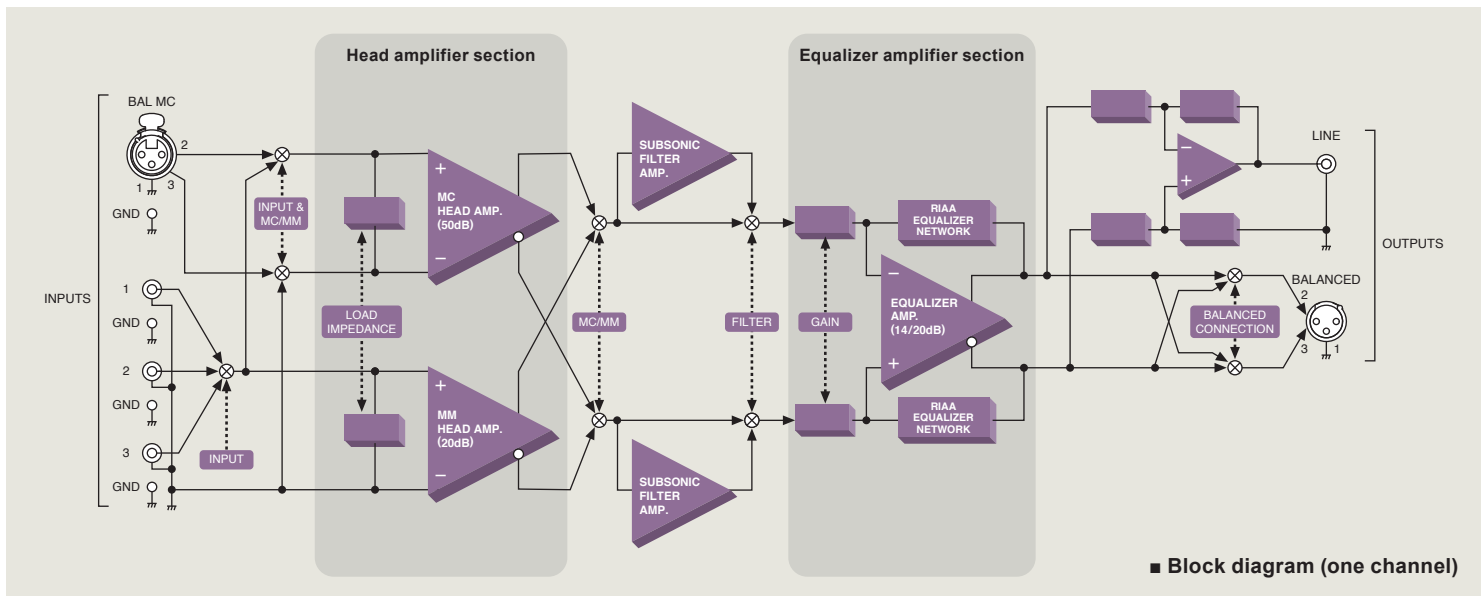
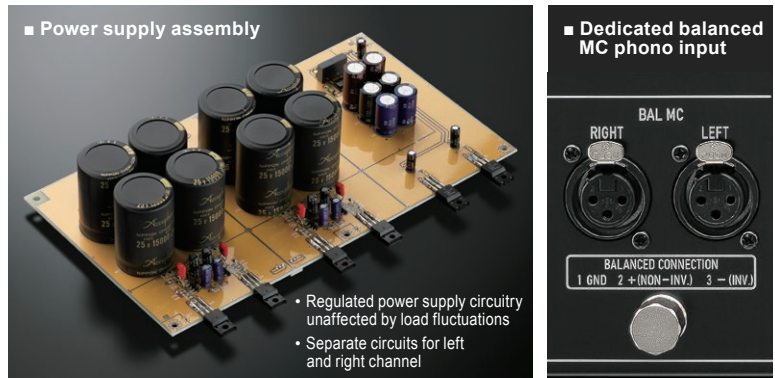

Advanced features

- Low-noise fully balanced configuration
- One dedicated balanced MC phono input and three sets of regular phono inputs
- Separate settings memory for each input position
- Balanced and line level output connectors
- Balanced output polarity selector
- Full mono construction
- Separate toroidal power transformers for left and right channel
- Low-noise regulated power supply circuitry unaffected by load fluctuations
- High-accuracy phono equalizer with RIAA deviation of only ± 0.3 dB
- Load impedance settings for six MC and three MM phono cartridge types
- 7-segment LED indicator shows load impedance
- Gain selector for low-output phono cartridges
- Built-in subsonic filter
- Disc equalizer assembly using glass cloth fluorocarbon resin PCBs with low dielectric constant and low losses
- Gold-plated printed circuit boards
- Aluminum top plate with hairline finish
- Elegant side panels with natural wood grain finish
- Supplied with premium quality "ASL-10" audio cables for best sound



Aluminum top plate with hairline finish



Elegant side panels with natural wood grain finish



MC / MM selector

GAIN selector

Subsonic filter button

Load impedance selector and 7-segment LED indicator

Input selector with added position for dedicated balanced MC phono input



Internal layout realizes full mono construction to prevent mutual interference between channels



High-capacitance 25 V / 15,000 μ F aluminum electrolytic capacitors for current smoothing



High-efficiency toroidal power transformer



Performance Graphs

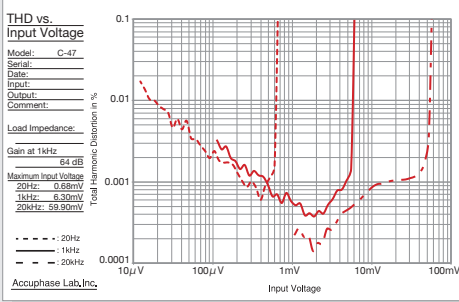

Input voltage vs. THD characteristics (MC input)

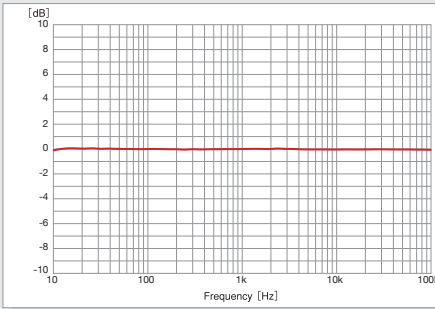

RIAA deviation (MC input)

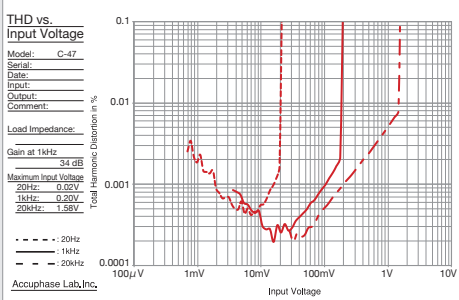

Input voltage vs. THD characteristics (MM input)

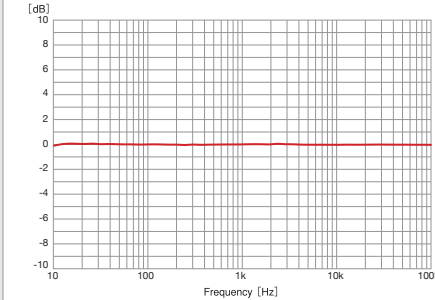

RIAA deviation (MM input)

Connection Example

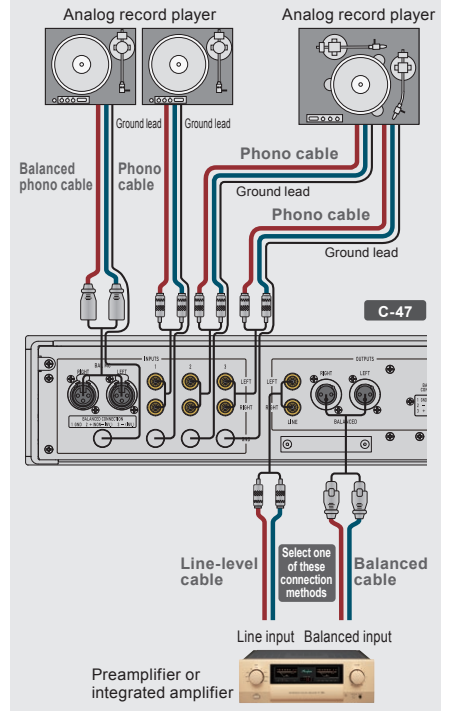

Front Panel

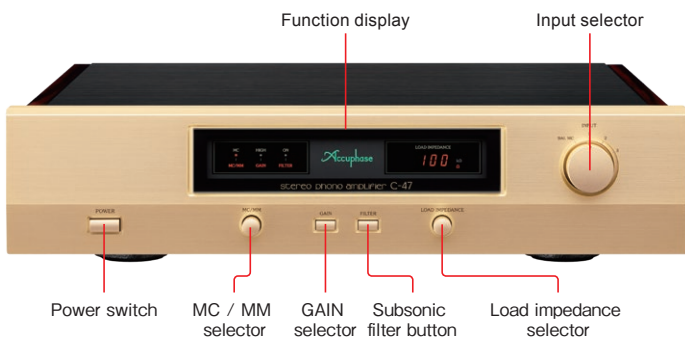

Rear Panel

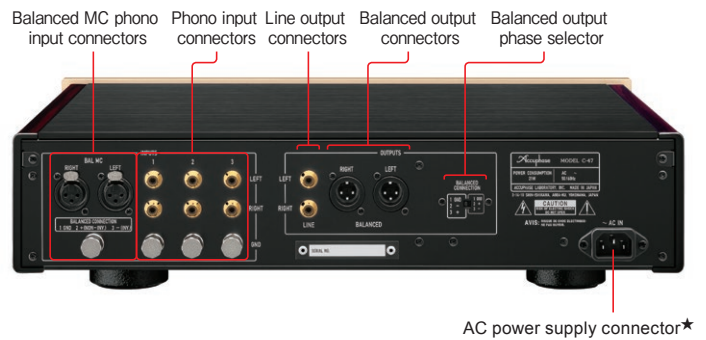

C-47 Guaranteed Specifications [Guaranteed specifications are measured according to EIA standard RS-490.]

RIAA Deviation	MC	10 – 20,000 Hz	±0.3 dB
	MM	10 – 20,000 Hz	±0.3 dB
Total Harmonic Distortion (1 kHz, at rated output)	0.005%		
Gain	GAIN selector OFF (Normal)	MC	64 dB
		MM	34 dB
	GAIN selector HIGH	MC	70 dB
		MM	40 dB
Input Sensitivity (1 kHz, for rated output)	MC	64 dB	1.26 mV
		70 dB	0.63 mV
	MM	34 dB	40 mV
		40 dB	20 mV
Maximum Input Voltage (1 kHz, 0.005% THD)	MC	64 dB	5.7 mV
		70 dB	2.9 mV
	MM	34 dB	180 mV
		40 dB	90 mV
Maximum Output Level (0.01% THD, 20 – 20,000 Hz)	BALANCED/LINE OUTPUT	8.0 V	
Input Impedance	MC	10 ohms, 30 ohms, 100 ohms, 200 ohms, 300 ohms, 1 kilohm	
	MM	1 kilohm, 47 kilohms, 100 kilohms	

Rated Output Voltage, Output Impedance	BALANCED OUTPUT	2 V 50 ohms	
	LINE OUTPUT	2 V 50 ohms	
S/N Ratio, Input-converted Noise	Input	Input shorted (A weighting)	
		S/N ratio at rated output	Input-converted noise
	MC: 64 dB	97 dB	-155 dBV
	MC: 70 dB	91 dB	-155 dBV
	MM: 34 dB	108 dB	-136 dBV
MM: 40 dB	102 dB	-136 dBV	
Minimum Load Impedance	BALANCED/LINE OUTPUT	10kilohms	
Crosstalk	-90 dB or less (10 kHz)		
Residual Noise (A-weighted, with input shorted)	GAIN selector OFF (Normal)	MC	28.2 µV or less
		MM	7.9 µV or less
	GAIN selector HIGH	MC	56.2 µV or less
		MM	15.8 µV or less
Subsonic Filter	-12 dB/octave, 10 Hz		
Power Requirements	120 V, 220 V, 230 V AC (voltage as indicated on rear panel), 50/60 Hz		
Power Consumption	21 W		
Maximum Dimensions	Width 465 mm (18.31") x Height 114 mm (4.49") x Depth 407 mm (16.02")		
Mass	Net	14.8 kg (32.6 lbs)	
	In shipping carton	21.0 kg (46.3 lbs)	

Remarks

- ★ This product is available in versions for 120/220/230 V AC. Make sure that the voltage shown on the rear panel matches the AC line voltage in your area.
- ★ The 230 V version has an Eco Mode that switches power off after 120 minutes of inactivity.
- ★ The shape of the plug of the supplied AC power cord depends on the voltage rating and destination country.

Supplied accessories

- AC power cord
- Audio cables ASL-10
- Cleaning cloth