

TEST REPORT

Application No.: SZEM2211007760BA
Applicant: NINGBO DEYE ESS TECHNOLOGY CO., LTD
Address of Applicant: No. 18, Zhenlong 2 Road, Binhai Economic Development Zone, Cixi, Ningbo, Zhejiang, China.
Manufacturer: NINGBO DEYE ESS TECHNOLOGY CO., LTD
Address of Manufacturer: No. 18, Zhenlong 2 Road, Binhai Economic Development Zone, Cixi, Ningbo, Zhejiang, China.
Factory: NINGBO DEYE ESS TECHNOLOGY CO., LTD
Address of Factory: No. 18, Zhenlong 2 Road, Binhai Economic Development Zone, Cixi, Ningbo, Zhejiang, China.

Equipment Under Test (EUT):

EUT Name: Rechargeable Li-ion Battery System
Model No.: BOS-G
Trade Mark: Deye
Standard(s) : EN IEC 61000-6-3: 2021
EN IEC 61000-6-1: 2019
Date of Receipt: 2022-11-07
Date of Test: 2022-11-17 to 2022-11-24
Date of Issue: 2022-11-25

Test Result:	Pass*
---------------------	--------------

* In the configuration tested, the EUT complied with the standards specified above.



Keny Xu
EMC Laboratory Manager



Unless otherwise agreed in writing, this document is issued by the Company subject to its General Conditions of Service printed overleaf, available on request or accessible at <http://www.sgs.com/en/Terms-and-Conditions.aspx> and, for electronic format documents, subject to Terms and Conditions for Electronic Documents at <http://www.sgs.com/en/Terms-and-Conditions/Terms-e-Document.aspx>. Attention is drawn to the limitation of liability, indemnification and jurisdiction issues defined therein. Any holder of this document is advised that information contained hereon reflects the Company's findings at the time of its intervention only and within the limits of Client's instructions, if any. The Company's sole responsibility is to its Client and this document does not exonerate parties to a transaction from exercising all their rights and obligations under the transaction documents. This document cannot be reproduced except in full, without prior written approval of the Company. Any unauthorized alteration, forgery or falsification of the content or appearance of this document is unlawful and offenders may be prosecuted to the fullest extent of the law. Unless otherwise stated the results shown in this test report refer only to the sample(s) tested and such sample(s) are retained for 30 days only.
Attention: To check the authenticity of testing / inspection report & certificate, please contact us at telephone: (86-755) 8307 1443, or email: CN.Doccheck@sgs.com

SGS-CSTC Standards Technical Services Co., Ltd. Shenzhen Branch

SZEMC-TRF-01 Rev. A/0 Aug01,2022

Report No.: SZEM221100776001

Page: 2 of 50

Revision Record			
Version	Description	Date	Remark
00	Original	2022-11-25	/

Authorized for issue by:			
			

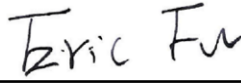
		Foray Chen/Project Engineer	
			

		Eric Fu/Reviewer	



SGS-CSTC Standards Technical Services Co., Ltd.
Shenzhen Branch

Unless otherwise agreed in writing, this document is issued by the Company subject to its General Conditions of Service printed overleaf, available on request or accessible at <http://www.sgs.com/en/Terms-and-Conditions.aspx> and, for electronic format documents, subject to Terms and Conditions for Electronic Documents at <http://www.sgs.com/en/Terms-and-Conditions/Terms-e-Documents.aspx>. Attention is drawn to the limitation of liability, indemnification and jurisdiction issues defined therein. Any holder of this document is advised that information contained hereon reflects the Company's findings at the time of its intervention only and within the limits of Client's instructions, if any. The Company's sole responsibility is to its Client and this document does not exonerate parties to a transaction from exercising all their rights and obligations under the transaction documents. This document cannot be reproduced except in full, without prior written approval of the Company. Any unauthorized alteration, forgery or falsification of the content or appearance of this document is unlawful and offenders may be prosecuted to the fullest extent of the law. Unless otherwise stated the results shown in this test report refer only to the sample(s) tested and such sample(s) are retained for 30 days only.
Attention: To check the authenticity of testing / inspection report & certificate, please contact us at telephone: (86-755) 8307 1443, or email: CN.Doccheck@sgs.com

No.1 Workshop, M-10, Middle Section, Science & Technology Park, Shenzhen, China 518057 t (86-755) 26012053 f (86-755) 26710594 www.sgs.com.cn
中国·深圳·科技园中区M-10栋一号厂房 邮编: 518057 t (86-755) 26012053 f (86-755) 26710594 sgs.china@sgs.com

2 Test Summary

Emission Part				
Item	Standard	Method	Requirement	Result
Conducted Emissions at AC Mains Power Port (150kHz-30MHz)	EN IEC 61000-6-3: 2021	CISPR 16-2-1	Table 4.3	Pass
Radiated Emissions (30MHz-1GHz)		CISPR 16-2-3	Table 3.1	Pass
Harmonic Current Emission		EN 61000-3-12: 2011	Clause 5.2	Pass
Voltage Fluctuations and Flicker		EN IEC 61000-3-11: 2019	Clause 6.3.2	Pass

Immunity Part				
Item	Standard	Method	Requirement	Result
Conducted Immunity at AC Mains Power Port (150kHz-80MHz)	EN IEC 61000-6-1: 2019	EN 61000-4-6:2014	3Vrms (emf),80%,1kHz Amp. Mod.	Pass
Electrical Fast Transients Burst at AC Mains Power Port		EN 61000-4-4:2012	1kV 5/50ns Tr/Td 5kHz/100kHz Repetition Frequency	Pass
Electrostatic Discharge		EN 61000-4-2:2009	±4kV Contact Discharge, ±8kV Air Discharge	Pass
Radiated Immunity (80MHz-6GHz)		EN IEC 61000-4-3: 2020	3V/m, 80%, 1kHz Amp. Mod.	Pass
Surge at AC Mains Power Port		EN 61000-4-5:2014+A1:2017	1.2/50µs Tr/Td 1kV Line to Line 2kV Line to Ground	Pass
Voltage Dips and Interruptions		EN IEC 61000-4-11:2020	0 % UT for 0.5cycle 0 % UT for 1cycle 70 % UT for 25cycles 0 % UT for 250cycles UT is Supply Voltage	Pass



Unless otherwise agreed in writing, this document is issued by the Company subject to its General Conditions of Service printed overleaf, available on request or accessible at <http://www.sgs.com/en/Terms-and-Conditions.aspx> and, for electronic format documents, subject to Terms and Conditions for Electronic Documents at <http://www.sgs.com/en/Terms-and-Conditions/Terms-e-Documents.aspx>. Attention is drawn to the limitation of liability, indemnification and jurisdiction issues defined therein. Any holder of this document is advised that information contained hereon reflects the Company's findings at the time of its intervention only and within the limits of Client's instructions, if any. The Company's sole responsibility is to its Client and this document does not exonerate parties to a transaction from exercising all their rights and obligations under the transaction documents. This document cannot be reproduced except in full, without prior written approval of the Company. Any unauthorized alteration, forgery or falsification of the content or appearance of this document is unlawful and offenders may be prosecuted to the fullest extent of the law. Unless otherwise stated the results shown in this test report refer only to the sample(s) tested and such sample(s) are retained for 30 days only.
Attention: To check the authenticity of testing /inspection report & certificate, please contact us at telephone: (86-755) 8307 1443, or email: CN.Doccheck@sgs.com

3 Contents

	Page
1 COVER PAGE	1
2 TEST SUMMARY	3
3 CONTENTS	4
4 GENERAL INFORMATION	6
4.1 DETAILS OF E.U.T.	6
4.2 DESCRIPTION OF SUPPORT UNITS	6
4.3 MEASUREMENT UNCERTAINTY	6
4.4 TEST LOCATION	7
4.5 TEST FACILITY	7
4.6 DEVIATION FROM STANDARDS	7
4.7 ABNORMALITIES FROM STANDARD CONDITIONS	7
5 EQUIPMENT LIST	8
6 EMISSION TEST RESULTS	13
6.1 CONDUCTED EMISSIONS AT AC MAINS POWER PORT (150KHZ-30MHZ)	13
6.1.1 <i>E.U.T. Operation</i>	13
6.1.2 <i>Test Mode Description</i>	13
6.1.3 <i>Test Setup Diagram</i>	13
6.1.4 <i>Measurement Procedure and Data</i>	14
6.2 RADIATED EMISSIONS (30MHZ-1GHZ)	19
6.2.1 <i>E.U.T. Operation</i>	19
6.2.2 <i>Test Mode Description</i>	19
6.2.3 <i>Test Setup Diagram</i>	19
6.2.4 <i>Measurement Procedure and Data</i>	20
6.3 HARMONIC CURRENT EMISSION	25
6.3.1 <i>E.U.T. Operation</i>	25
6.3.2 <i>Test Mode Description</i>	25
6.3.3 <i>Test Setup Diagram</i>	25
6.3.4 <i>Measurement Procedure and Data</i>	25
6.4 VOLTAGE FLUCTUATIONS AND FLICKER	31
6.4.1 <i>E.U.T. Operation</i>	31
6.4.2 <i>Test Mode Description</i>	31
6.4.3 <i>Test Setup Diagram</i>	31
6.4.4 <i>Measurement Procedure and Data</i>	31
7 IMMUNITY TEST RESULTS	34
7.1 CONDUCTED IMMUNITY AT AC MAINS POWER PORT (150KHZ-80MHZ)	35
7.1.1 <i>Test Setup Diagram</i>	35
7.1.2 <i>E.U.T. Operation</i>	35
7.1.3 <i>Test Mode Description</i>	35
7.1.4 <i>Test Condition and Results:</i>	35



Unless otherwise agreed in writing, this document is issued by the Company subject to its General Conditions of Service printed overleaf, available on request or accessible at <http://www.sgs.com/en/Terms-and-Conditions.aspx> and, for electronic format documents, subject to Terms and Conditions for Electronic Documents at <http://www.sgs.com/en/Terms-and-Conditions/Terms-e-Document.aspx>. Attention is drawn to the limitation of liability, indemnification and jurisdiction issues defined therein. Any holder of this document is advised that information contained hereon reflects the Company's findings at the time of its intervention only and within the limits of Client's instructions, if any. The Company's sole responsibility is to its Client and this document does not exonerate parties to a transaction from exercising all their rights and obligations under the transaction documents. This document cannot be reproduced except in full, without prior written approval of the Company. Any unauthorized alteration, forgery or falsification of the content or appearance of this document is unlawful and offenders may be prosecuted to the fullest extent of the law. Unless otherwise stated the results shown in this test report refer only to the sample(s) tested and such sample(s) are retained for 30 days only.

7.2	ELECTRICAL FAST TRANSIENTS BURST AT AC MAINS POWER PORT	36
7.2.1	Test Setup Diagram	36
7.2.2	E.U.T. Operation	36
7.2.3	Test Mode Description	36
7.2.4	Test Condition and Results:	36
7.3	ELECTROSTATIC DISCHARGE	37
7.3.1	Test Setup Diagram	37
7.3.2	E.U.T. Operation	37
7.3.3	Test Mode Description	37
7.3.4	Test Condition and Results:	37
7.4	RADIATED IMMUNITY (80MHZ-6GHZ)	39
7.4.1	Test Setup Diagram	39
7.4.2	E.U.T. Operation	39
7.4.3	Test Mode Description	39
7.4.4	Test Condition and Results:	39
7.5	SURGE AT AC MAINS POWER PORT	41
7.5.1	Test Setup Diagram	41
7.5.2	E.U.T. Operation	41
7.5.3	Test Mode Description	41
7.5.4	Test Condition and Results:	41
7.6	VOLTAGE DIPS AND INTERRUPTIONS	43
7.6.1	Test Setup Diagram	43
7.6.2	E.U.T. Operation	43
7.6.3	Test Mode Description	43
7.6.4	Test Condition and Results:	43
8	TEST SETUP PHOTO	45



4 General Information

4.1 Details of E.U.T.

Power supply:	DC 51.2V/100A Test Voltage: AC 400V/50Hz & DC 51.2V
Cable(s):	DC Power cable

4.2 Description of Support Units

Description	Manufacturer	Model No.	Serial No.
Load	Resistance	N/A	N/A
Power Source	APC	APF400	N/A

4.3 Measurement Uncertainty

No.	Item	Measurement Uncertainty (U_{LAB}) *	U_{CISPR}
1	Conducted Emission at mains port using AMN	2.4dB (9kHz to 150kHz)	3.8dB (9kHz to 150kHz)
		2.2dB (150kHz to 30MHz)	3.4dB (150kHz to 30MHz)
2	Conducted Emission at telecommunication port using AAN	4.0 dB (150kHz to 30MHz)	5.0dB (150kHz to 30MHz)
3	Radiated Power	3.2dB	4.5dB (30MHz to 300MHz)
4	Radiated Emission (10m)	4.1 dB	6.3dB (30MHz-1GHz)
5	Radiated Emission (3m)	4.6 dB (30MHz-1GHz)	6.3dB (30MHz-1GHz)
		5.0dB (1GHz-6GHz)	5.2dB (1GHz-6GHz)
		5.2dB (6GHz-18GHz)	5.5dB (6GHz-18GHz)
		5.3dB (18GHz-40GHz)	N/A

Note: The measurement uncertainty represents an expanded uncertainty expressed at approximately the 95% confidence level using a coverage factor of k=2.

Decision Rule:

- CISPR 16-4-2 for emission measurements is as below described.
Pass means the test result passed the test standard requirement, please find the detailed decision rule in the report relative section.
 U_{LAB} less than U_{CISPR} , therefore:
 - compliance is deemed to occur if no measured disturbance level exceeds the disturbance limit.
 - non-compliance is deemed to occur if any measured disturbance level exceeds the disturbance limit.
- For immunity testing no decision rule is applicable.



4.4 Test Location

All tests were sub-contracted at:

Compliance Certification Services (Kunshan) Inc.

No.10 Weiye Rd, Innovation park, Eco&Tec, Development Zone, Kunshan City, Jiangsu, China.

Tel: +86 512 5735 5888 Fax: +86 512 5737 0818

Note:

1.SGS is not responsible for wrong test results due to incorrect information (e.g., max. internal working frequency, antenna gain, cable loss, etc) is provided by the applicant. (If applicable).

2.SGS is not responsible for the authenticity, integrity and the validity of the conclusion based on results of the data provided by applicant. (If applicable).

4.5 Test Facility

The test facility is recognized, certified, or accredited by the following organizations:

• CNAS

Compliance Certification Services (Kunshan) Inc. is accredited by the China National Accreditation Service for Conformity Assessment (CNAS). Registration No. CNAS L4354

• A2LA

Compliance Certification Services (Kunshan) Inc. is accredited by the American Association for Laboratory Accreditation (A2LA). Certificate No. 2541.01.

• FCC

Compliance Certification Services (Kunshan) Inc. has been recognized as an accredited testing laboratory. Designation Number: CN1172.

• ISED

Compliance Certification Services (Kunshan) Inc. has been recognized by Innovation, Science and Economic Development Canada (ISED) as an accredited testing laboratory. Company Number: 2324E

• VCCI

The 3m and 10m Semi-anechoic chamber and Shielded Room of Compliance Certification Services (Kunshan) Inc. has been registered in accordance with the Regulations for Voluntary Control Measures with Registration No.: R-20134, R-11600, C-11707, T-11499, G-10216 respectively.

4.6 Deviation from Standards

None

4.7 Abnormalities from Standard Conditions

None



5 Equipment List

Conducted Emissions at AC Mains Power Port (150kHz-30MHz)					
Equipment	Manufacturer	Model No.	Inventory No.	Cal Date	Cal Due Date
EMI TEST RECEIVER	R&S	ESCI	KS301101	01/22/2022	01/21/2023
TWO-LINE V-NETWORK	R&S	ENV216	KS301197	01/22/2022	01/21/2023
V (V-LISN)	SCHWARZBECK	NNLK 8129	KS301091	01/22/2022	01/21/2023
Pulse LIMITER	R&S	ESH3-Z2	KUS1902E001	01/22/2022	01/21/2023
Software	Faratronic	EZ_EMV-3A1	N/A	N/A	N/A

Radiated Emissions (30MHz-1GHz)					
Equipment	Manufacturer	Model No.	Inventory No.	Cal Date	Cal Due Date
EMI Test Receiver	R&S	ESCI	KS301044	01/22/2022	01/21/2023
EMI Test Receiver	R&S	ESCI	KS301195	08/22/2022	08/21/2023
Bilog Antenna	Sunol	JB1	CZ301033	02/28/2022	02/27/2023
Bilog Antenna	Sunol	JB1	KS301013	04/12/2022	04/11/2023
Pre-Amplifier	Anritsu	MH648A	KS610098	01/22/2022	01/21/2023
Pre-Amplifier	Mini-circuits	ZFL-1000VH2	CZ301013	01/22/2022	01/21/2023
Software	Faratronic	EZ_EMV-3A1	N/A	N/A	N/A

Harmonic Current Emission					
Equipment	Manufacturer	Model No.	Inventory No.	Cal Date	Cal Due Date
Harmonic & Flicker Tester	SCHAFFNER	CCN 1000-1	KS301033	08/22/2022	08/21/2023
AC Power Source	SCHAFFNER	NSG 1007	KS301087	08/22/2022	08/21/2023
Software	TESEQ	CTS4-v 4.24.0	N/A	N/A	N/A
Harmonic/Flicker Analyzer	KIKUSUI	KHA3000	KUS2009M002-1	04/01/2022	03/31/2023
Line Impedance Network	KIKUSUI	SPEC71116	KUS2009M002-1	04/01/2022	03/31/2023
Switcher	KIKUSUI	SPEC71092	KUS2009M002-2	04/01/2022	03/31/2023
AC Power Supply(Master)	KIKUSUI	PCR24000WE 2	KUS2009M002-3	04/01/2022	03/31/2023
AC Power Supply(Slave)	KIKUSUI	PCR24000WE 2	KUS2009M002-4	04/01/2022	03/31/2023
Software	KIKUSUI	HarmoCapture 3-vv 2.5.2.00	N/A	N/A	N/A



SGS-CSTC Standards Technical Services Co., Ltd. Shenzhen Branch

SZEMC-TRF-01 Rev. A/0 Aug01,2022

Report No.: SZEM221100776001

Page: 9 of 50

Voltage Fluctuations and Flicker					
Equipment	Manufacturer	Model No.	Inventory No.	Cal Date	Cal Due Date
Harmonic & Flicker Tester	SCHAFFNER	CCN 1000-1	KS301033	08/22/2022	08/21/2023
AC Power Source	SCHAFFNER	NSG 1007	KS301087	08/22/2022	08/21/2023
Software	TESEQ	CTS4-v 4.24.0	N/A	N/A	N/A
Harmonic/Flicker Analyzer	KIKUSUI	KHA3000	KUS2009M002-1	04/01/2022	03/31/2023
Line Impedance Network	KIKUSUI	SPEC71116	KUS2009M002-1	04/01/2022	03/31/2023
Switcher	KIKUSUI	SPEC71092	KUS2009M002-2	04/01/2022	03/31/2023
AC Power Supply(Master)	KIKUSUI	PCR24000WE 2	KUS2009M002-3	04/01/2022	03/31/2023
AC Power Supply(Slave)	KIKUSUI	PCR24000WE 2	KUS2009M002-4	04/01/2022	03/31/2023
Software	KIKUSUI	HarmoCapture 3-vv 2.5.2.00	N/A	N/A	N/A

Conducted Immunity at AC Mains Power Port (150kHz-80MHz)					
Equipment	Manufacturer	Model No.	Inventory No.	Cal Date	Cal Due Date
Test System for Conducted and Radiated Immunity	TESEQ	NSG 4070B	KSZZ01705E0 03	01/22/2022	01/21/2023
Amplifier	TESEQ	SCCXE75	KSZZ01705E0 04	01/22/2022	01/21/2023
EM-Koppelzange	SCHAFFNER	KEMZ 801	CZ301002	01/22/2022	01/21/2023
Attenuator	EURO MC	7860 ORGEVAL	CZ301084	04/01/2022	03/31/2023
Directional Coupler	HIGH POWER	C21A8	CZ750021	09/06/2022	09/05/2023
CDN (Coupling and Decoupling Network)	SCHAFFNER	CDN M216	CZ301085	04/01/2022	03/31/2023
CDN (Coupling and Decoupling Network)	SCHAFFNER	CDN M316	CZ301025	04/01/2022	03/31/2023
CDN (Coupling and Decoupling Network)	TESEQ	CDN S751	KS301184-2	04/01/2022	03/31/2023
CDN (Coupling and Decoupling Network)	TESEQ	CDN M116	KS301184-1	04/01/2022	03/31/2023
CDN	TESEQ	CDN T2-10S	KS301286	04/01/2022	03/31/2023
CDN	TESEQ	CDN T4-10S	KS301287	04/01/2022	03/31/2023
CDN	TESEQ	CDN T8-10S	KS301288	04/01/2022	03/31/2023



Unless otherwise agreed in writing, this document is issued by the Company subject to its General Conditions of Service printed overleaf, available on request or accessible at <http://www.sgs.com/en/Terms-and-Conditions.aspx> and, for electronic format documents, subject to Terms and Conditions for Electronic Documents at <http://www.sgs.com/en/Terms-and-Conditions/Terms-e-Documents.aspx>. Attention is drawn to the limitation of liability, indemnification and jurisdiction issues defined therein. Any holder of this document is advised that information contained hereon reflects the Company's findings at the time of its intervention only and within the limits of Client's instructions, if any. The Company's sole responsibility is to its Client and this document does not exonerate parties to a transaction from exercising all their rights and obligations under the transaction documents. This document cannot be reproduced except in full, without prior written approval of the Company. Any unauthorized alteration, forgery or falsification of the content or appearance of this document is unlawful and offenders may be prosecuted to the fullest extent of the law. Unless otherwise stated the results shown in this test report refer only to the sample(s) tested and such sample(s) are retained for 30 days only.

SGS-CSTC Standards Technical Services Co., Ltd.
Shenzhen Branch

No.1 Workshop, M-10, Middle Section, Science & Technology Park, Shenzhen, China 518057 t (86-755) 26012053 f (86-755) 26710594 www.sgs.com.cn
中国·深圳·科技园中区M-10栋一号厂房 邮编: 518057 t (86-755) 26012053 f (86-755) 26710594 sgs.china@sgs.com

SGS-CSTC Standards Technical Services Co., Ltd. Shenzhen Branch

SZEMC-TRF-01 Rev. A/0 Aug01,2022

Report No.: SZEM221100776001

Page: 10 of 50

Current Clamp	TESEQ	IP-DR250	KS201703E001	04/01/2022	03/31/2023
CDN	TESEQ	CDN M432	KUS2003M001-1	01/22/2022	01/21/2023
CDN	TESEQ	CDN M432-3LN	KUS2003M001-2	01/22/2022	01/21/2023
CDN	TESEQ	CDN M532	KUS2003M001-3	01/26/2022	01/25/2023
CDN	TESEQ	CDN M232	KSZZ201706E001	04/01/2022	03/31/2023
CDN	TESEQ	CDN M332	KSZZ201706E002	04/01/2022	03/31/2023
Software	TESEQ	NSG 4070-v 1.3.0.1	N/A	N/A	N/A

Electrical Fast Transients Burst at AC Mains Power Port

Equipment	Manufacturer	Model No.	Inventory No.	Cal Date	Cal Due Date
EMC Immunity Tester	EMC PARTNER	Transient2000	KS301188-1	08/22/2022	08/21/2023
Coupling Network	EMC PARTNER	CN-EFT1000	KS301188-3	08/22/2022	08/21/2023
Burst Generator	SANKI	EFT-0404S	KUS2009M002-7	04/01/2022	03/31/2023
Coupling and Decoupling Network	SANKI	CDN-4350	KUS2009M002-8	04/01/2022	03/31/2023

Electrostatic Discharge

Equipment	Manufacturer	Model No.	Inventory No.	Cal Date	Cal Due Date
ESD Simulator	EM TEST	DITO 509030	KS301147	01/26/2022	01/25/2023

Radiated Immunity (80MHz-6GHz)

Equipment	Manufacturer	Model No.	Inventory No.	Cal Date	Cal Due Date
Synthesized Signal Generator	AGILENT	83732B	KS301183	01/22/2022	01/21/2023
Laser probe interface	AR Worldwide	FI7000	KS301193-2	04/01/2022	03/31/2023
E-Field Sensor	AR Worldwide	FL7006 100K-6G	KS301193-1	04/01/2022	03/31/2023
Amplifier Research (80~1000MHz 150w)	AR Worldwide	150W1000M1	KS301139	08/22/2022	08/21/2023
Amplifier Research (1~6GHz 50w)	AR Worldwide	50S1G6M1	KS301231	08/22/2022	08/21/2023
Dual Directional Coupler (1-11G)	AR Worldwide	C1-A47NFNF 35dB	KS301193-5	N.C.R	N.C.R



SGS-CSTC Standards Technical Services Co., Ltd.
Shenzhen Branch, Shenzhen EMC Laboratory.

Unless otherwise agreed in writing, this document is issued by the Company subject to its General Conditions of Service printed overleaf, available on request or accessible at <http://www.sgs.com/en/Terms-and-Conditions.aspx> and, for electronic format documents, subject to Terms and Conditions for Electronic Documents at <http://www.sgs.com/en/Terms-and-Conditions/Terms-e-Documents.aspx>. Attention is drawn to the limitation of liability, indemnification and jurisdiction issues defined therein. Any holder of this document is advised that information contained hereon reflects the Company's findings at the time of its intervention only and within the limits of Client's instructions, if any. The Company's sole responsibility is to its Client and this document does not exonerate parties to a transaction from exercising all their rights and obligations under the transaction documents. This document cannot be reproduced except in full, without prior written approval of the Company. Any unauthorized alteration, forgery or falsification of the content or appearance of this document is unlawful and offenders may be prosecuted to the fullest extent of the law. Unless otherwise stated the results shown in this test report refer only to the sample(s) tested and such sample(s) are retained for 30 days only.

Attention: To check the authenticity of testing /inspection report & certificate, please contact us at telephone: (86-755) 8307 1443, or email: CN_Doccheck@sgs.com
No.1 Workshop, M-10, Middle Section, Science & Technology Park, Shenzhen, China 518057 t (86-755) 26012053 f (86-755) 26710594 www.sgs.com.cn
中国·深圳·科技园中区M-10栋一号厂房 邮编: 518057 t (86-755) 26012053 f (86-755) 26710594 sgs.china@sgs.com

SGS-CSTC Standards Technical Services Co., Ltd. Shenzhen Branch

SZEMC-TRF-01 Rev. A/0 Aug01,2022

Report No.: SZEM221100776001

Page: 11 of 50

Dual Directional Coupler (80~1000MHz 400w)	AR Worldwide	DC6180	KS301193-6	N.C.R	N.C.R
RF POWER METER	BOONTON	4232A-01	KS301022	01/22/2022	01/21/2023
POWER SENSOR	BOONTON	51085	H3010235-1	01/22/2022	01/21/2023
POWER SENSOR	BOONTON	51085	H3010235-2	01/22/2022	01/21/2023
Antenna	AR Worldwide	TP1000A	CZ301029	N.C.R	N.C.R
Software	AR	emc ware-v 3.2.0.4	N/A	N/A	N/A

Surge at AC Mains Power Port

Equipment	Manufacturer	Model No.	Inventory No.	Cal Date	Cal Due Date
EMC Immunity Tester	EMC PARTNER	TRA2006	KS301188-1	08/22/2022	08/21/2023
Coupling and Decoupling Network	EMC PARTNER	CDN-UTP8	KS301188-2	08/22/2022	08/21/2023
Surge Generator	SANKI	LSG-0506S	KUS2009M002-5	04/01/2022	03/31/2023
Coupling and Decoupling Network	SANKI	CDN-5350	KUS2009M002-6	04/01/2022	03/31/2023

Voltage Dips and Interruptions

Equipment	Manufacturer	Model No.	Inventory No.	Cal Date	Cal Due Date
EMC Immunity Tester	EMC PARTNER	TRA2006	KS301188-1	08/22/2022	08/21/2023
Switcher	KIKUSUI	SPEC71092	KUS2009M002-2	04/01/2022	03/31/2023
AC Power Supply(Master)	KIKUSUI	PCR24000WE 2	KUS2009M002-3	04/01/2022	03/31/2023
AC Power Supply(Slave)	KIKUSUI	PCR24000WE 2	KUS2009M002-4	04/01/2022	03/31/2023
Software	KIKUSUI	Quick Immunity Sequencer 2-v 4.0.3.02	N/A	N/A	N/A



SGS-CSTC Standards Technical Services Co., Ltd.
Shenzhen Branch (EMC) Laboratory

Unless otherwise agreed in writing, this document is issued by the Company subject to its General Conditions of Service printed overleaf, available on request or accessible at <http://www.sgs.com/en/Terms-and-Conditions.aspx> and, for electronic format documents, subject to Terms and Conditions for Electronic Documents at <http://www.sgs.com/en/Terms-and-Conditions/Terms-e-Documents.aspx>. Attention is drawn to the limitation of liability, indemnification and jurisdiction issues defined therein. Any holder of this document is advised that information contained hereon reflects the Company's findings at the time of its intervention only and within the limits of Client's instructions, if any. The Company's sole responsibility is to its Client and this document does not exonerate parties to a transaction from exercising all their rights and obligations under the transaction documents. This document cannot be reproduced except in full, without prior written approval of the Company. Any unauthorized alteration, forgery or falsification of the content or appearance of this document is unlawful and offenders may be prosecuted to the fullest extent of the law. Unless otherwise stated the results shown in this test report refer only to the sample(s) tested and such sample(s) are retained for 30 days only.
Attention: To check the authenticity of testing /inspection report & certificate, please contact us at telephone: (86-755) 8307 1443, or email: CN.Doccheck@sgs.com

No.1 Workshop, M-10, Middle Section, Science & Technology Park, Shenzhen, China 518057 t (86-755) 26012053 f (86-755) 26710594 www.sgsgroup.com.cn
中国·深圳·科技园中区M-10栋一号厂房 邮编: 518057 t (86-755) 26012053 f (86-755) 26710594 sgs.china@sgs.com

SGS-CSTC Standards Technical Services Co., Ltd. Shenzhen Branch

SZEMC-TRF-01 Rev. A/0 Aug01,2022

Report No.: SZEM221100776001

Page: 12 of 50

General used equipment					
Equipment	Manufacturer	Model No.	Inventory No.	Cal Date	Cal Due Date
Digital Pressure Meter	Mengde	DYM3	CZ750023	02/01/2022	01/31/2023
Temperature & Humidity Recorder	Anymetre	TH603	CZ720001-1 CZ720001-2 CZ720001-3 CZ720001-4 CZ720001-5 CZ720001-6 CZ720001-7	10/13/2022	10/12/2023



SGS-CSTC Standards Technical Services Co., Ltd.
Shenzhen Branch

Unless otherwise agreed in writing, this document is issued by the Company subject to its General Conditions of Service printed overleaf, available on request or accessible at <http://www.sgs.com/en/Terms-and-Conditions.aspx> and, for electronic format documents, subject to Terms and Conditions for Electronic Documents at <http://www.sgs.com/en/Terms-and-Conditions/Terms-e-Documents.aspx>. Attention is drawn to the limitation of liability, indemnification and jurisdiction issues defined therein. Any holder of this document is advised that information contained hereon reflects the Company's findings at the time of its intervention only and within the limits of Client's instructions, if any. The Company's sole responsibility is to its Client and this document does not exonerate parties to a transaction from exercising all their rights and obligations under the transaction documents. This document cannot be reproduced except in full, without prior written approval of the Company. Any unauthorized alteration, forgery or falsification of the content or appearance of this document is unlawful and offenders may be prosecuted to the fullest extent of the law. Unless otherwise stated the results shown in this test report refer only to the sample(s) tested and such sample(s) are retained for 30 days only.
Attention: To check the authenticity of testing / inspection report & certificate, please contact us at telephone: (86-755) 8307 1443, or email: CN.Doccheck@sgs.com

No.1 Workshop, M-10, Middle Section, Science & Technology Park, Shenzhen, China 518057 t (86-755) 26012053 f (86-755) 26710594 www.sgs.com.cn
中国·深圳·科技园中区M-10栋一号厂房 邮编: 518057 t (86-755) 26012053 f (86-755) 26710594 sgs.china@sgs.com

6 Emission Test Results

6.1 Conducted Emissions at AC Mains Power Port (150kHz-30MHz)

Test Requirement: EN IEC 61000-6-3: 2021

Test Method: CISPR 16-2-1

Limit:

0.15M-0.5MHz 66dB(μV)-56dB(μV) quasi-peak, 56dB(μV)-46dB(μV) average

0.5M-5MHz 56dB(μV) quasi-peak, 46dB(μV) average

5M-30MHz 60dB(μV) quasi-peak, 50dB(μV) average

Detector: Peak for pre-scan (9kHz resolution bandwidth) 0.15M to 30MHz

6.1.1 E.U.T. Operation

Operating Environment:

Temperature: 22.5 °C Humidity: 60 % RH Atmospheric Pressure: 1010 mbar

6.1.2 Test Mode Description

Pre-scan / Final test	Mode Code	Description
Final test	00	Charging Mode.

6.1.3 Test Setup Diagram

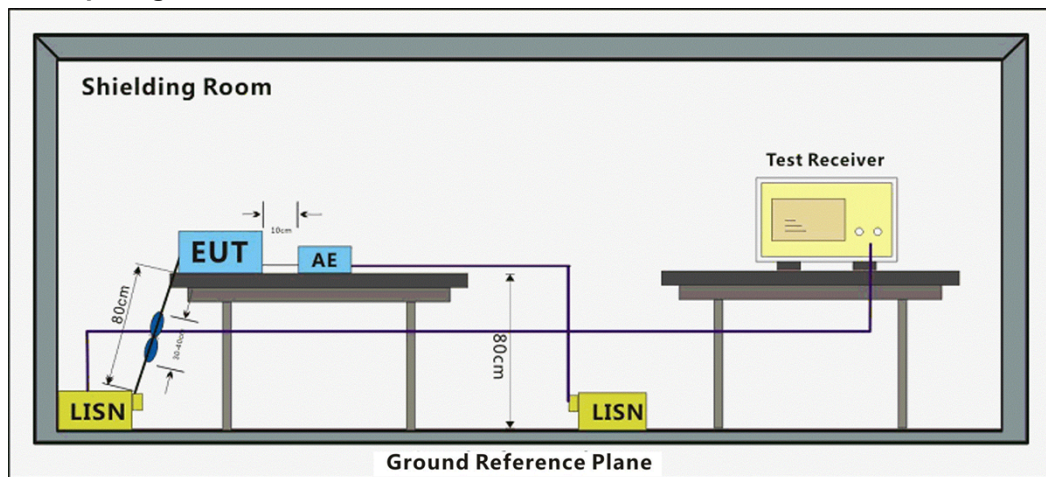

6.1.4 Measurement Procedure and Data

Frequency range: 150KHz-30MHz

An initial pre-scan was performed with peak detector. Quasi-Peak or Average measurement were performed at the frequencies with maximized peak emission were detected.

The red line show in graphic is the limit in standard used in this section.

Measured Level = Read level + Cable Loss + LISN Factor



Test Mode: 00; Line: Live line

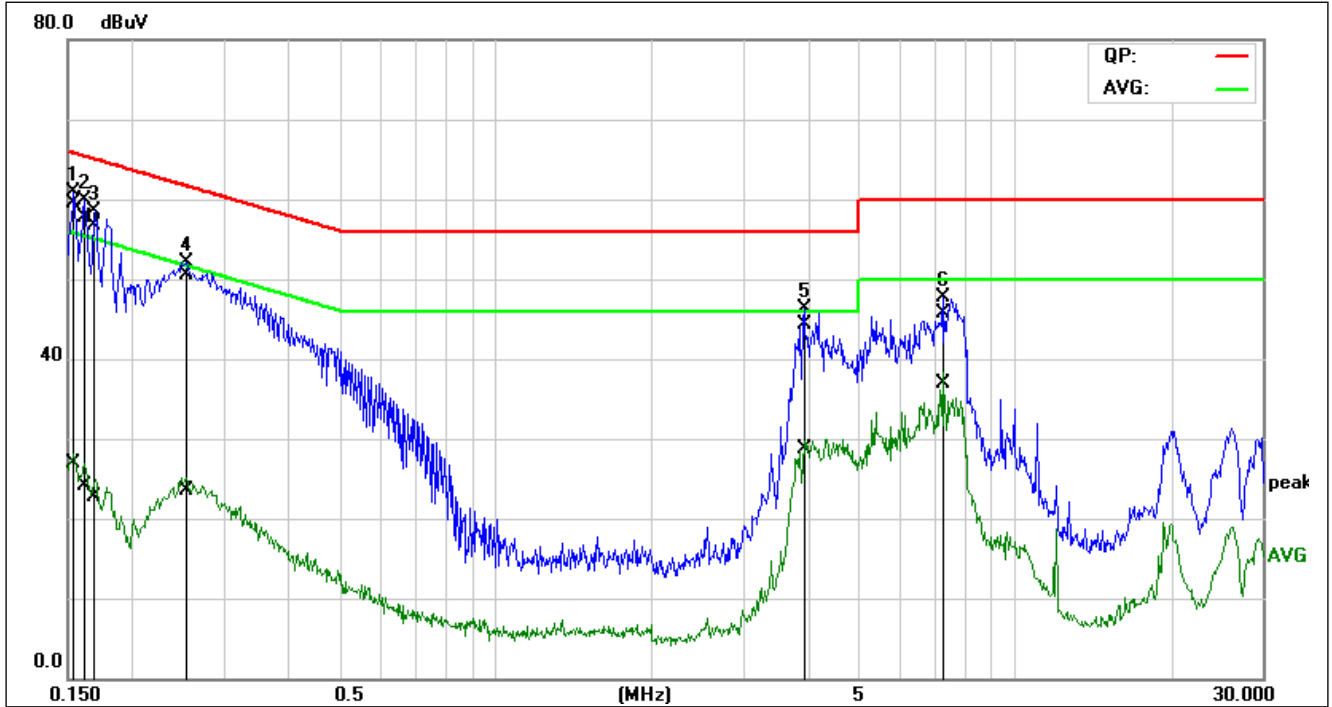

No.	Frequency (MHz)	QuasiPeak reading (dBuV)	Average reading (dBuV)	Correction factor (dB)	QuasiPeak result (dBuV)	Average result (dBuV)	QuasiPeak limit (dBuV)	Average limit (dBuV)	QuasiPeak margin (dB)	Average margin (dB)	Remark
1*	0.1540	49.56	16.88	9.97	59.53	26.85	65.78	55.78	-6.25	-28.93	Pass
2	0.1620	47.69	14.16	9.97	57.66	24.13	65.36	55.36	-7.70	-31.23	Pass
3	0.1700	46.77	12.68	9.97	56.74	22.65	64.96	54.96	-8.22	-32.31	Pass
4	0.2540	40.48	13.47	9.99	50.47	23.46	61.63	51.63	-11.16	-28.17	Pass
5	3.9420	34.08	18.47	10.21	44.29	28.68	56.00	46.00	-11.71	-17.32	Pass
6	7.2740	35.40	26.48	10.36	45.76	36.84	60.00	50.00	-14.24	-13.16	Pass



Test Mode: 00; Line: Live line

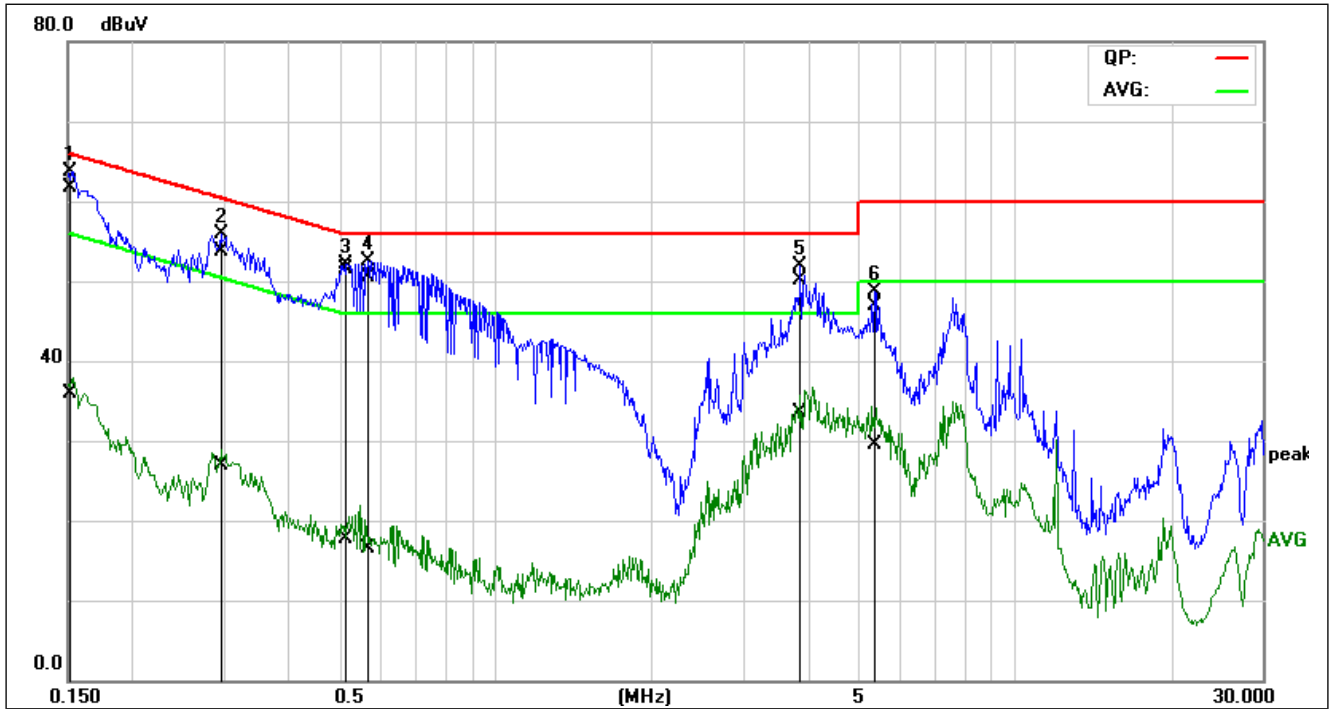

No.	Frequency (MHz)	QuasiPeak reading (dBuV)	Average reading (dBuV)	Correction factor (dB)	QuasiPeak result (dBuV)	Average result (dBuV)	QuasiPeak limit (dBuV)	Average limit (dBuV)	QuasiPeak margin (dB)	Average margin (dB)	Remark
1*	0.1524	51.73	25.85	10.01	61.74	35.86	65.87	55.87	-4.13	-20.01	Pass
2	0.2955	43.69	16.96	10.00	53.69	26.96	60.37	50.37	-6.68	-23.41	Pass
3	0.5180	41.42	7.64	10.05	51.47	17.69	56.00	46.00	-4.53	-28.31	Pass
4	0.5700	40.39	6.43	10.05	50.44	16.48	56.00	46.00	-5.56	-29.52	Pass
5	3.8700	39.92	23.34	10.21	50.13	33.55	56.00	46.00	-5.87	-12.45	Pass
6	5.3900	36.61	19.24	10.25	46.86	29.49	60.00	50.00	-13.14	-20.51	Pass



Unless otherwise agreed in writing, this document is issued by the Company subject to its General Conditions of Service printed overleaf, available on request or accessible at <http://www.sgs.com/en/Terms-and-Conditions.aspx> and, for electronic format documents, subject to Terms and Conditions for Electronic Documents at <http://www.sgs.com/en/Terms-and-Conditions/Terms-e-Documents.aspx>. Attention is drawn to the limitation of liability, indemnification and jurisdiction issues defined therein. Any holder of this document is advised that information contained hereon reflects the Company's findings at the time of its intervention only and within the limits of Client's instructions, if any. The Company's sole responsibility is to its Client and this document does not exonerate parties to a transaction from exercising all their rights and obligations under the transaction documents. This document cannot be reproduced except in full, without prior written approval of the Company. Any unauthorized alteration, forgery or falsification of the content or appearance of this document is unlawful and offenders may be prosecuted to the fullest extent of the law. Unless otherwise stated the results shown in this test report refer only to the sample(s) tested and such sample(s) are retained for 30 days only.

Test Mode: 00; Line: Live line

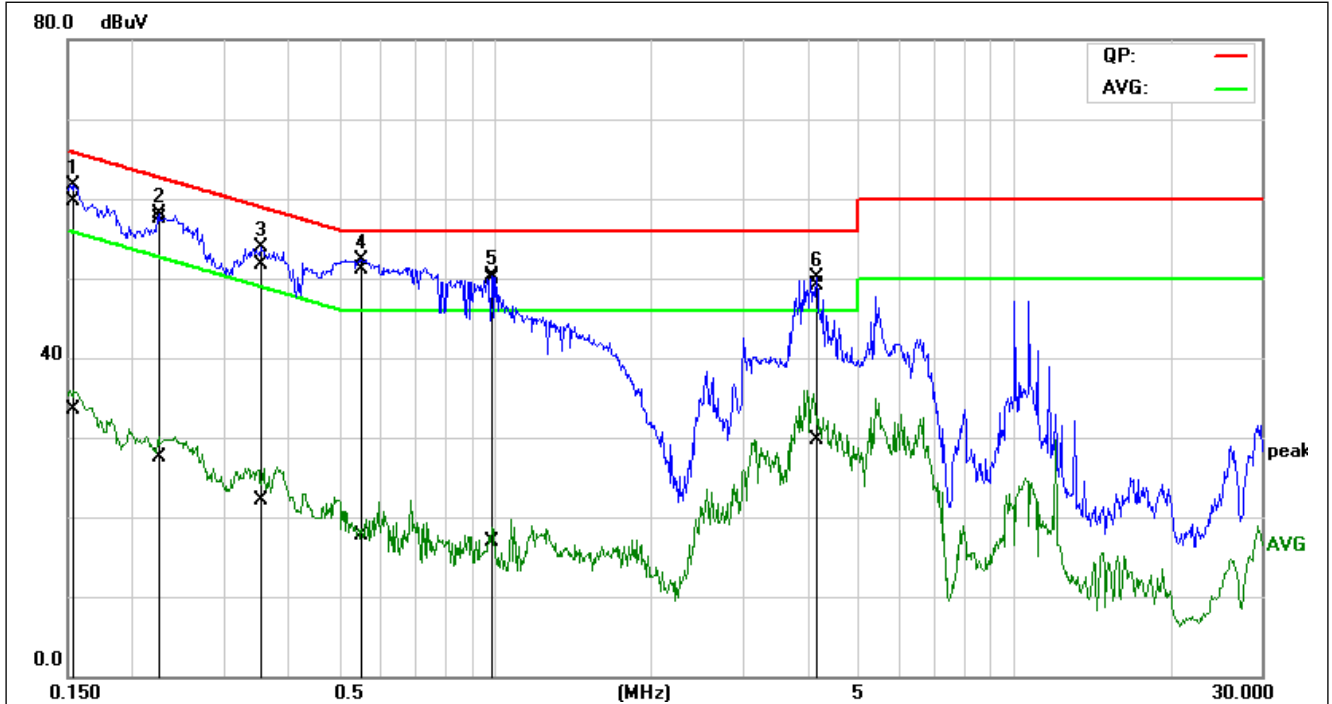

No.	Frequency (MHz)	QuasiPeak reading (dBuV)	Average reading (dBuV)	Correction factor (dB)	QuasiPeak result (dBuV)	Average result (dBuV)	QuasiPeak limit (dBuV)	Average limit (dBuV)	QuasiPeak margin (dB)	Average margin (dB)	Remark
1	0.1540	49.68	23.45	10.01	59.69	33.46	65.78	55.78	-6.09	-22.32	Pass
2	0.2244	47.43	17.41	10.01	57.44	27.42	62.65	52.65	-5.21	-25.23	Pass
3	0.3540	41.68	12.16	10.01	51.69	22.17	58.87	48.87	-7.18	-26.70	Pass
4*	0.5540	41.03	7.63	10.05	51.08	17.68	56.00	46.00	-4.92	-28.32	Pass
5	0.9860	39.77	6.77	10.09	49.86	16.86	56.00	46.00	-6.14	-29.14	Pass
6	4.1740	38.90	19.48	10.21	49.11	29.69	56.00	46.00	-6.89	-16.31	Pass



Test Mode: 00; Line: Neutral Line

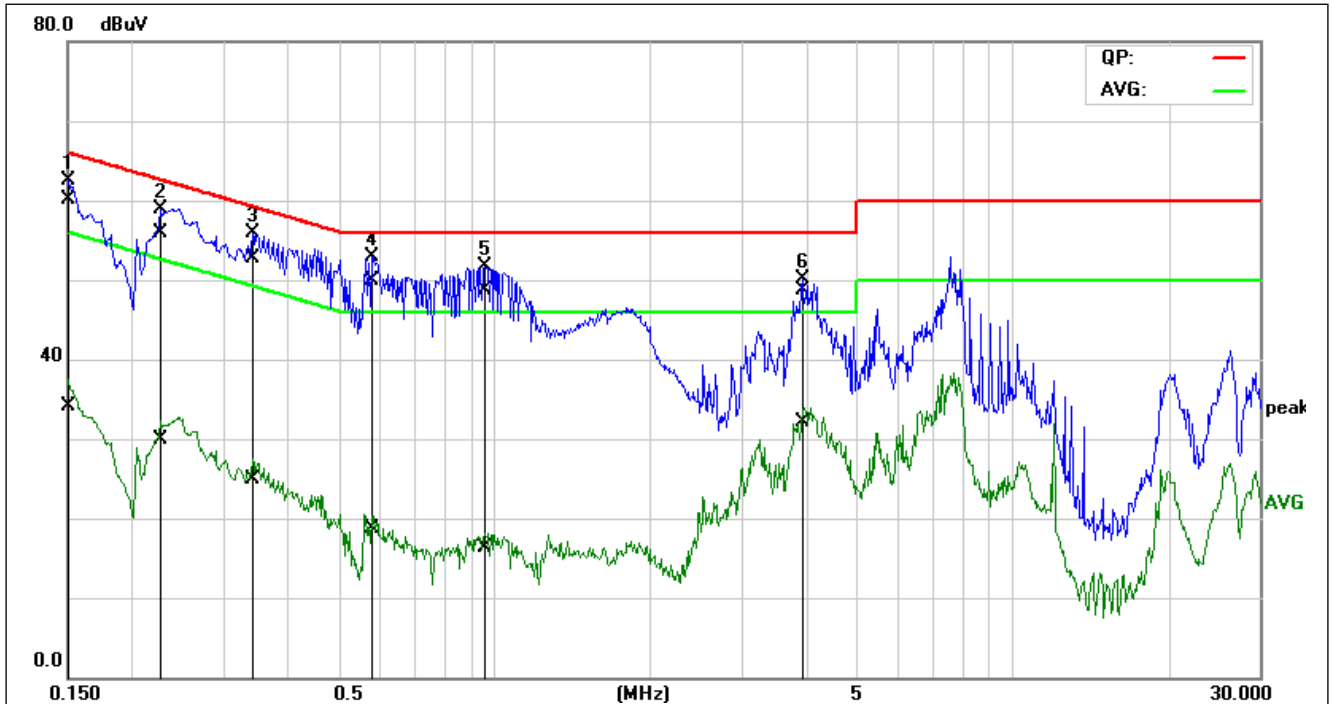

No.	Frequency (MHz)	QuasiPeak reading (dBuV)	Average reading (dBuV)	Correction factor (dB)	QuasiPeak result (dBuV)	Average result (dBuV)	QuasiPeak limit (dBuV)	Average limit (dBuV)	QuasiPeak margin (dB)	Average margin (dB)	Remark
1*	0.1508	50.09	24.13	10.03	60.12	34.16	65.96	55.96	-5.84	-21.80	Pass
2	0.2268	45.83	19.83	10.03	55.86	29.86	62.57	52.57	-6.71	-22.71	Pass
3	0.3420	42.73	14.82	10.03	52.76	24.85	59.15	49.15	-6.39	-24.30	Pass
4	0.5820	39.90	8.66	10.08	49.98	18.74	56.00	46.00	-6.02	-27.26	Pass
5	0.9620	38.57	6.12	10.11	48.68	16.23	56.00	46.00	-7.32	-29.77	Pass
6	3.9420	38.52	21.91	10.23	48.75	32.14	56.00	46.00	-7.25	-13.86	Pass



6.2 Radiated Emissions (30MHz-1GHz)

Test Requirement: EN IEC 61000-6-3: 2021
 Test Method: CISPR 16-2-3

Limit:

Test Distance: 10m
 30MHz-230MHz 30 dB(μV/m) quasi-peak
 230MHz-1GHz 37 dB(μV/m) quasi-peak
 Detector: Peak for pre-scan (120kHz resolution bandwidth) 30MHz to 1000MHz

6.2.1 E.U.T. Operation

Operating Environment:
 Temperature: 24 °C Humidity: 48 % RH Atmospheric Pressure: 1010 mbar

6.2.2 Test Mode Description

Pre-scan / Final test	Mode Code	Description
Final test	00	Charging Mode.
Final test	01	Discharging Mode.

6.2.3 Test Setup Diagram

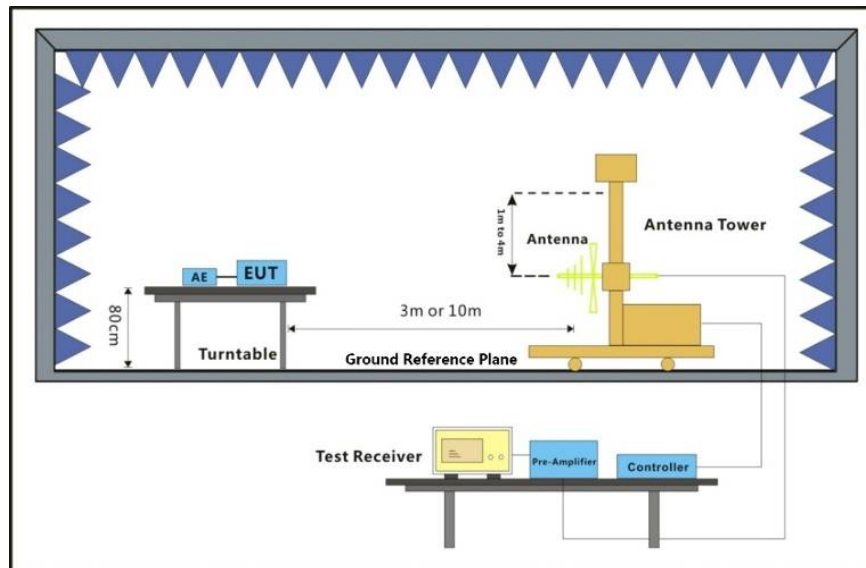

Unless otherwise agreed in writing, this document is issued by the Company subject to its General Conditions of Service printed overleaf, available on request or accessible at <http://www.sgs.com/en/Terms-and-Conditions.aspx> and, for electronic format documents, subject to Terms and Conditions for Electronic Documents at <http://www.sgs.com/en/Terms-and-Conditions/Terms-e-Documents.aspx>. Attention is drawn to the limitation of liability, indemnification and jurisdiction issues defined therein. Any holder of this document is advised that information contained hereon reflects the Company's findings at the time of its intervention only and within the limits of Client's instructions, if any. The Company's sole responsibility is to its Client and this document does not exonerate parties to a transaction from exercising all their rights and obligations under the transaction documents. This document cannot be reproduced except in full, without prior written approval of the Company. Any unauthorized alteration, forgery or falsification of the content or appearance of this document is unlawful and offenders may be prosecuted to the fullest extent of the law. Unless otherwise stated the results shown in this test report refer only to the sample(s) tested and such sample(s) are retained for 30 days only.
 Attention: To check the authenticity of testing / inspection report & certificate, please contact us at telephone: (86-755) 8307 1443, or email: CN_Doccheck@sgs.com

6.2.4 Measurement Procedure and Data

Frequency range: 30MHz-1GHz

An initial pre-scan was performed in the chamber using the spectrum analyser in peak detection mode. Quasi-peak measurements were conducted based on the peak sweep graph. The EUT was measured by BiConiLog antenna with 2 orthogonal polarities. The red line show in graphic is the limit in standard used in this section.

Level=Read Level + Antenna Factor + Cable Loss - Preamp Factor



Test Mode: 00; Polarity: Horizontal

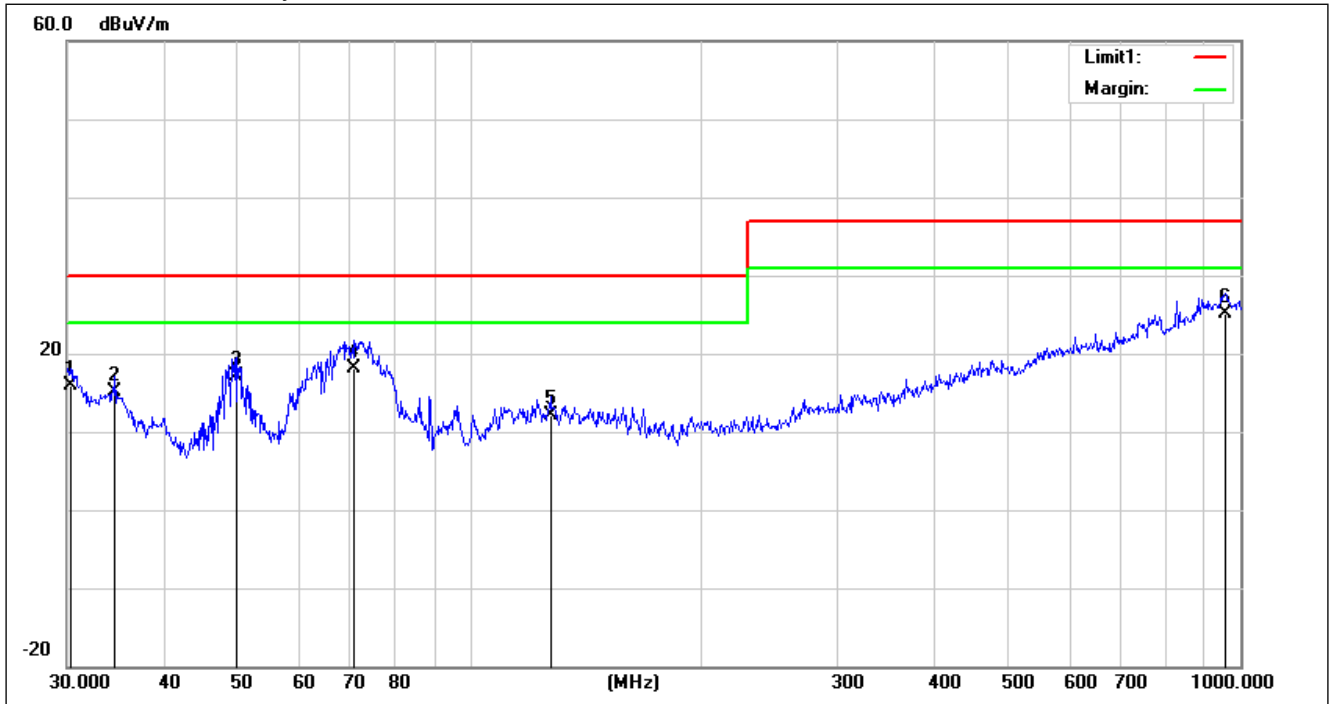

No.	Frequency (MHz)	Reading (dBuV)	Correct Factor(dB/m)	Result (dBuV/m)	Limit (dBuV/m)	Margin (dB)	Height (cm)	Degree (deg)	Remark
1	30.3173	25.46	-9.62	15.84	30.00	-14.16	200	27	QP
2	34.6385	27.88	-12.85	15.03	30.00	-14.97	200	64	QP
3	49.8814	38.18	-21.15	17.03	30.00	-12.97	200	24	QP
4	70.8315	39.59	-21.47	18.12	30.00	-11.88	200	231	QP
5	127.2176	26.79	-14.64	12.15	30.00	-17.85	200	134	QP
6	955.4381	25.04	0.08	25.12	37.00	-11.88	103	0	QP



Test Mode: 00; Polarity: Vertical

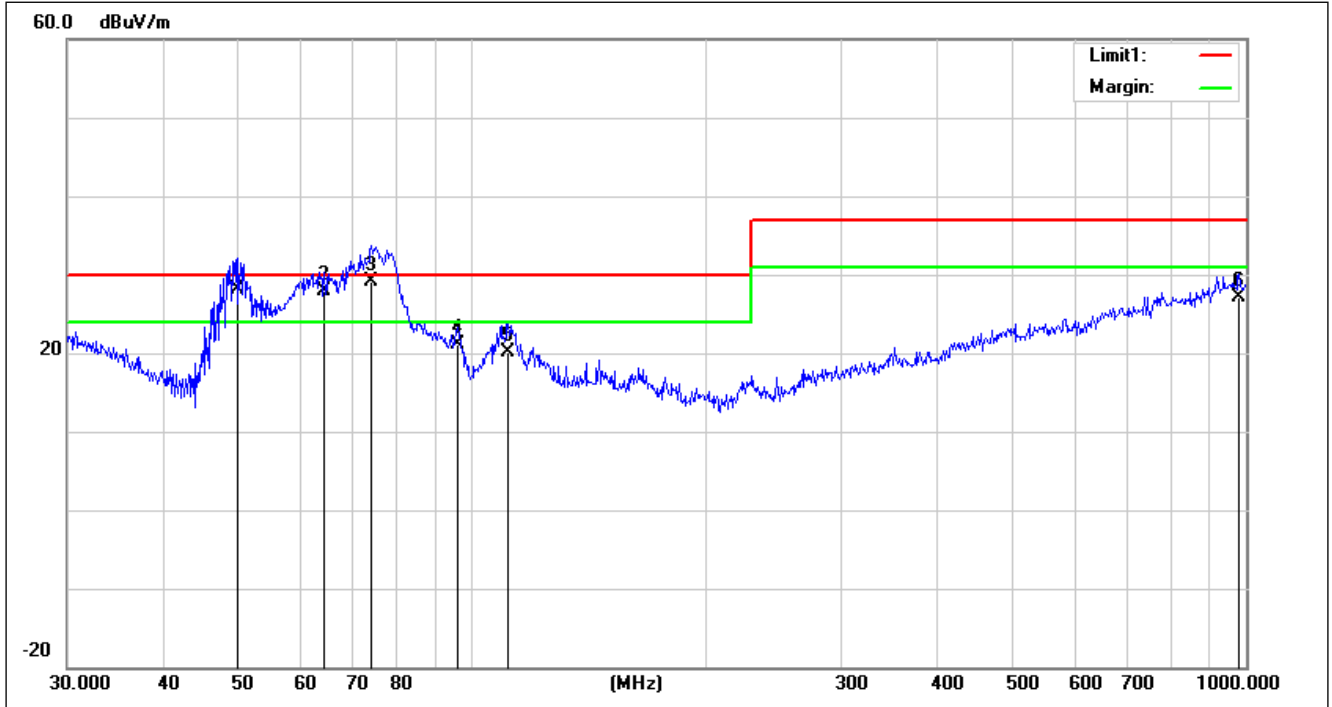

No.	Frequency (MHz)	Reading (dBuV)	Correct Factor (dB/m)	Result (dBuV/m)	Limit (dBuV/m)	Margin (dB)	Height (cm)	Degree (deg)	Remark
1	49.8814	42.88	-14.76	28.12	30.00	-1.88	101	230	QP
2	64.4331	43.20	-15.21	27.99	30.00	-2.01	200	0	QP
3	74.1351	43.99	-14.81	29.18	30.00	-0.82	200	210	QP
4	95.7622	34.36	-13.33	21.03	30.00	-8.97	200	242	QP
5	111.3468	29.52	-9.40	20.12	30.00	-9.88	101	279	QP
6	979.1804	22.96	4.06	27.02	37.00	-9.98	200	246	QP



Test Mode: 01; Polarity: Horizontal

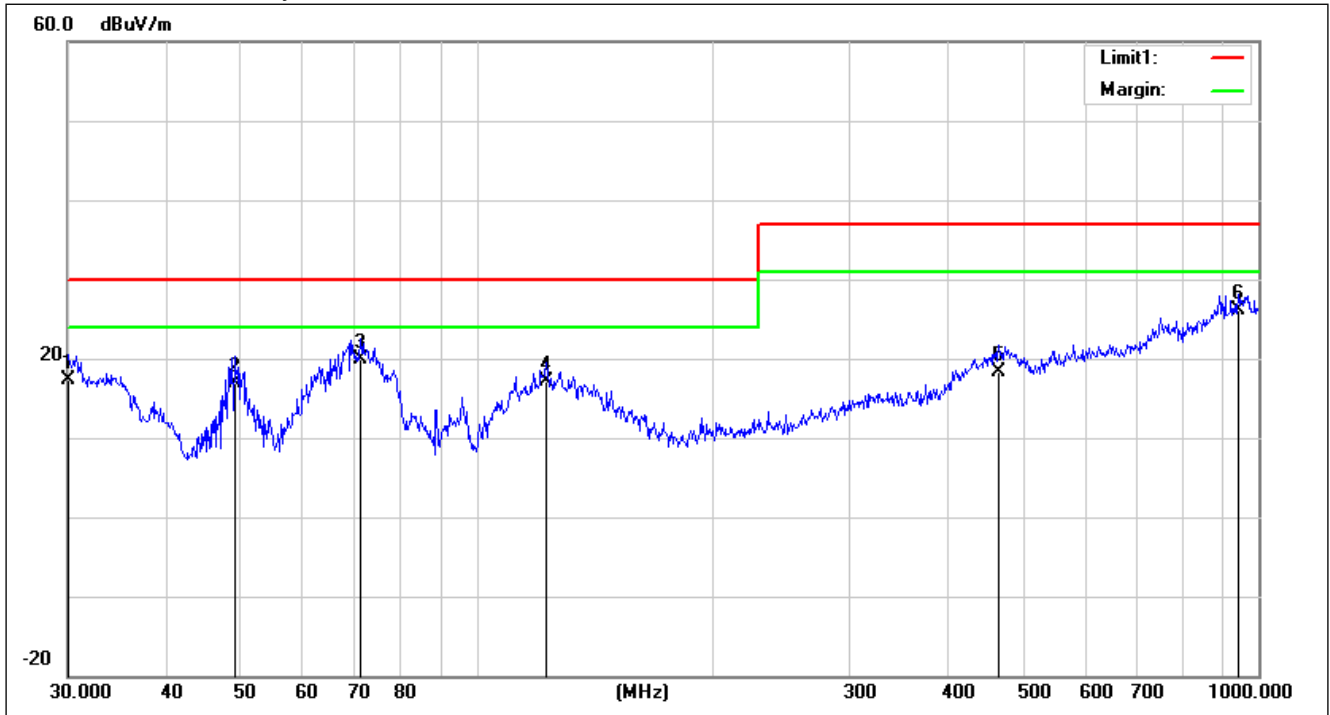

No.	Frequency (MHz)	Reading (dBuV)	Correct Factor(dB/m)	Result (dBuV/m)	Limit (dBuV/m)	Margin (dB)	Height (cm)	Degree (deg)	Remark
1	30.0000	26.70	-9.38	17.32	30.00	-12.68	200	200	QP
2	49.0145	37.70	-20.86	16.84	30.00	-13.16	200	55	QP
3	71.0803	41.29	-21.45	19.84	30.00	-10.16	200	200	QP
4	122.8340	31.65	-14.64	17.01	30.00	-12.99	200	41	QP
5	465.5994	28.03	-9.70	18.33	37.00	-18.67	100	74	QP
6	942.1305	26.34	-0.32	26.02	37.00	-10.98	200	30	QP



Unless otherwise agreed in writing, this document is issued by the Company subject to its General Conditions of Service printed overleaf, available on request or accessible at <http://www.sgs.com/en/Terms-and-Conditions.aspx> and, for electronic format documents, subject to Terms and Conditions for Electronic Documents at <http://www.sgs.com/en/Terms-and-Conditions/Terms-e-Documents.aspx>. Attention is drawn to the limitation of liability, indemnification and jurisdiction issues defined therein. Any holder of this document is advised that information contained hereon reflects the Company's findings at the time of its intervention only and within the limits of Client's instructions, if any. The Company's sole responsibility is to its Client and this document does not exonerate parties to a transaction from exercising all their rights and obligations under the transaction documents. This document cannot be reproduced except in full, without prior written approval of the Company. Any unauthorized alteration, forgery or falsification of the content or appearance of this document is unlawful and offenders may be prosecuted to the fullest extent of the law. Unless otherwise stated the results shown in this test report refer only to the sample(s) tested and such sample(s) are retained for 30 days only.
 Attention: To check the authenticity of testing /inspection report & certificate, please contact us at telephone: (86-755) 8307 1443, or email: CN.Doccheck@sgs.com

Test Mode: 01; Polarity: Vertical

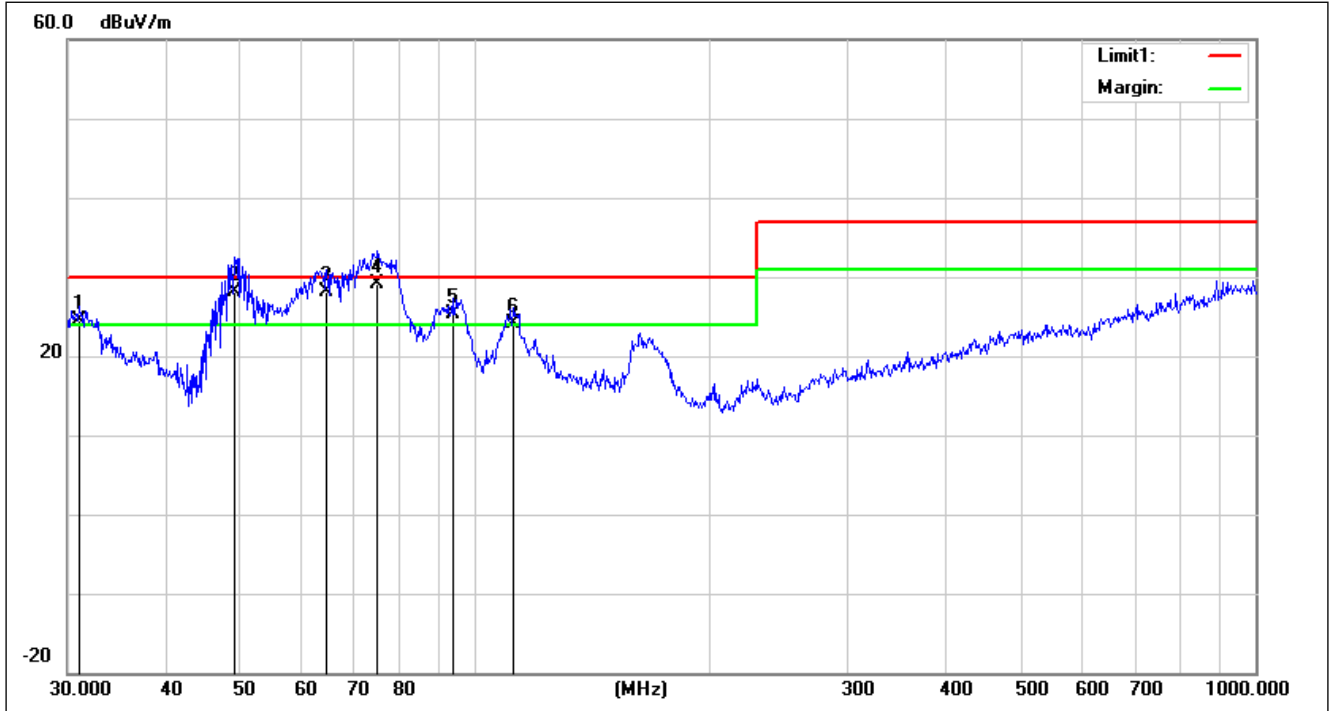

No.	Frequency (MHz)	Reading (dBuV)	Correct Factor(dB/m)	Result (dBuV/m)	Limit (dBuV/m)	Margin (dB)	Height (cm)	Degree (deg)	Remark
1	31.0706	28.37	-3.84	24.53	30.00	-5.47	104	363	QP
2	49.0145	42.65	-14.47	28.18	30.00	-1.82	100	227	QP
3	64.4331	43.33	-15.21	28.12	30.00	-1.88	200	339	QP
4	74.9191	43.85	-14.81	29.04	30.00	-0.96	200	241	QP
5	93.4402	39.23	-13.90	25.33	30.00	-4.67	200	45	QP
6	111.7380	33.34	-9.33	24.01	30.00	-5.99	200	265	QP



Unless otherwise agreed in writing, this document is issued by the Company subject to its General Conditions of Service printed overleaf, available on request or accessible at <http://www.sgs.com/en/Terms-and-Conditions.aspx> and, for electronic format documents, subject to Terms and Conditions for Electronic Documents at <http://www.sgs.com/en/Terms-and-Conditions/Terms-e-Documents.aspx>. Attention is drawn to the limitation of liability, indemnification and jurisdiction issues defined therein. Any holder of this document is advised that information contained hereon reflects the Company's findings at the time of its intervention only and within the limits of Client's instructions, if any. The Company's sole responsibility is to its Client and this document does not exonerate parties to a transaction from exercising all their rights and obligations under the transaction documents. This document cannot be reproduced except in full, without prior written approval of the Company. Any unauthorized alteration, forgery or falsification of the content or appearance of this document is unlawful and offenders may be prosecuted to the fullest extent of the law. Unless otherwise stated the results shown in this test report refer only to the sample(s) tested and such sample(s) are retained for 30 days only.

6.3 Harmonic Current Emission

Test Requirement: EN IEC 61000-6-3: 2021
 Test Method: EN 61000-3-12: 2011

6.3.1 E.U.T. Operation

Operating Environment:
 Temperature: 22.1 °C Humidity: 57.4 % RH Atmospheric Pressure: 1010 mbar

6.3.2 Test Mode Description

Pre-scan / Final test	Mode Code	Description
Final test	00	Charging Mode.

6.3.3 Test Setup Diagram

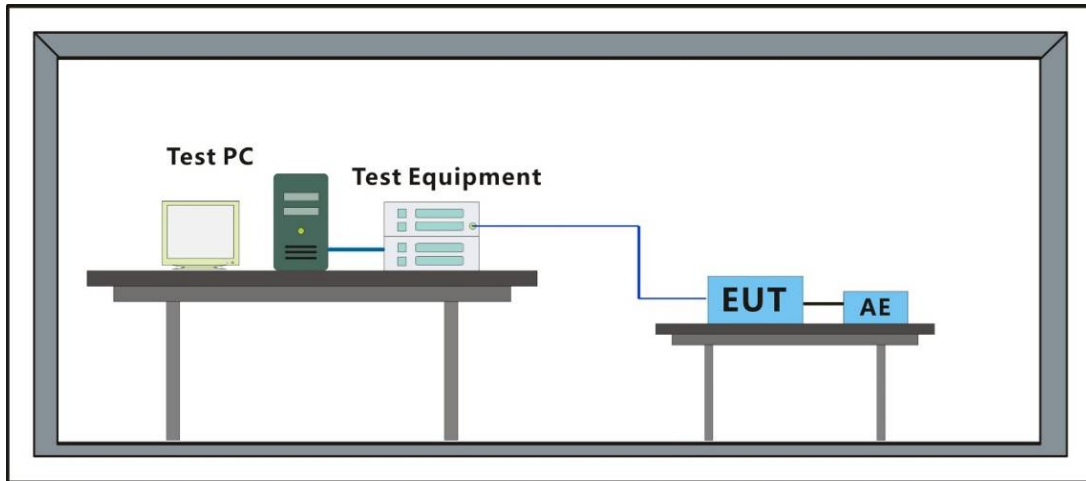

6.3.4 Measurement Procedure and Data

Frequency Range: 100Hz to 2kHz



Unless otherwise agreed in writing, this document is issued by the Company subject to its General Conditions of Service printed overleaf, available on request or accessible at <http://www.sgs.com/en/Terms-and-Conditions.aspx> and, for electronic format documents, subject to Terms and Conditions for Electronic Documents at <http://www.sgs.com/en/Terms-and-Conditions/Terms-e-Documents.aspx>. Attention is drawn to the limitation of liability, indemnification and jurisdiction issues defined therein. Any holder of this document is advised that information contained hereon reflects the Company's findings at the time of its intervention only and within the limits of Client's instructions, if any. The Company's sole responsibility is to its Client and this document does not exonerate parties to a transaction from exercising all their rights and obligations under the transaction documents. This document cannot be reproduced except in full, without prior written approval of the Company. Any unauthorized alteration, forgery or falsification of the content or appearance of this document is unlawful and offenders may be prosecuted to the fullest extent of the law. Unless otherwise stated the results shown in this test report refer only to the sample(s) tested and such sample(s) are retained for 30 days only.
 Attention: To check the authenticity of testing / inspection report & certificate, please contact us at telephone: (86-755) 8307 1443, or email: CN.Doccheck@sgs.com

SGS-CSTC Standards Technical Services Co., Ltd. Shenzhen Branch

SZEMC-TRF-01 Rev. A/0 Aug01,2022

Report No.: SZEM221100776001

Page: 26 of 50

Test Mode: 00;

Judgment	
Final Test Result	Pass
L1 Test Result	Pass
L2 Test Result	Pass
L3 Test Result	Pass

Test Data of Total Values	
Total Current (max)	21.80 A
Total Power (max)	14.996 kW
Total Power Factor (max)	0.9998
Total Apparent Power (max)	15.000 kVA
Total Reactive Power (max)	-0.084 kvar



Setting List

Items	Contents		
Limitation Standard	IEC 61000-3-2 Ed4.0		
Measurement Technic	IEC 61000-4-7 Ed2.1		
Wiring Method	3P4W		
Voltage Range	L1 600V,	L2 600V,	L3 600V
Current Range	L1 40.0A,	L2 40.0A,	L3 40.0A
Class	A		
Nominal Voltage	230.0 V		
Nominal Frequency	50.00 Hz		
Measurement Time	2 min 30 s		
Margin	100 %		
Definition of Power	Specified		
Specified Power Value	10.0 W		
Current Input Terminal	L1 BNC,	L2 BNC,	L3 BNC



Test Data of L1 Harmonics Current

Voltage (max)	229.46 V	THC (max)	0.03 A
Current (max)	21.27 A	POHC (max) / Limit	0.02 A / ----- *4
Power (setting)	10.00 W *1	Apparent Power (max)	4.881 kVA
Power Factor (max)	0.9997	Reactive Power (max)	-0.114 kvar
Fundamental Current (max)	21.27 A	THD (max)	0.19 %

Order	Limit1[A rms]	Limit2[A rms]	Ave[A rms]	Max[A rms]	LimitOver[s]	Judge
1	-----	-----	21.14	21.27	-----	N/A
2	1.0800	2.1600	0.00	0.00	0.0	N/A
3	2.3000	4.6000	0.00	0.01	0.0	N/A
4	0.4300	0.8600	0.00	0.00	0.0	N/A
5	1.1400	2.2800	0.00	0.00	0.0	N/A
6	0.3000	0.6000	0.00	0.00	0.0	N/A
7	0.7700	1.5400	0.01	0.01	0.0	N/A
8	0.2300	0.4600	0.00	0.01	0.0	N/A
9	0.4000	0.8000	0.01	0.01	0.0	N/A
10	0.1840	0.3680	0.00	0.01	0.0	N/A
11	0.3300	0.6600	0.01	0.01	0.0	N/A
12	0.1533	0.3067	0.00	0.00	0.0	N/A
13	0.2100	0.4200	0.00	0.00	0.0	N/A
14	0.1314	0.2629	0.00	0.00	0.0	N/A
15	0.1500	0.3000	0.00	0.00	0.0	N/A
16	0.1150	0.2300	0.00	0.00	0.0	N/A
17	0.1324	0.2647	0.00	0.01	0.0	N/A
18	0.1022	0.2044	0.00	0.00	0.0	N/A
19	0.1184	0.2368	0.01	0.01	0.0	N/A
20	0.0920	0.1840	0.00	0.00	0.0	N/A
21	0.1071	0.2143	0.00	0.00	0.0	N/A
22	0.0836	0.1673	0.00	0.00	0.0	N/A
23	0.0978	0.1957	0.01	0.01	0.0	N/A
24	0.0767	0.1533	0.00	0.00	0.0	N/A
25	0.0900	0.1800	0.01	0.01	0.0	N/A
26	0.0708	0.1415	0.00	0.00	0.0	N/A
27	0.0833	0.1667	0.00	0.00	0.0	N/A
28	0.0657	0.1314	0.00	0.00	0.0	N/A
29	0.0776	0.1552	0.01	0.01	0.0	N/A
30	0.0613	0.1227	0.00	0.00	0.0	N/A
31	0.0726	0.1452	0.01	0.01	0.0	N/A
32	0.0575	0.1150	0.00	0.00	0.0	N/A
33	0.0682	0.1364	0.00	0.00	0.0	N/A
34	0.0541	0.1082	0.00	0.00	0.0	N/A
35	0.0643	0.1286	0.01	0.01	0.0	N/A
36	0.0511	0.1022	0.00	0.00	0.0	N/A
37	0.0608	0.1216	0.00	0.01	0.0	N/A
38	0.0484	0.0968	0.00	0.00	0.0	N/A
39	0.0577	0.1154	0.00	0.01	0.0	N/A
40	0.0460	0.0920	0.00	0.00	0.0	N/A

N/A : Not Apply

*1 The value for power specified by the manufacturer.

*4 When the Edition 3.0 is applied, 200% of the Limit1 value is applied to each Limit2 value.



Test Data of L2 Harmonics Current

Voltage (max)	229.42 V	THC (max)	0.03 A
Current (max)	22.38 A	POHC (max) / Limit	0.02 A / ----- *4
Power (setting)	10.00 W *1	Apparent Power (max)	5.134 kVA
Power Factor (max)	0.9999	Reactive Power (max)	-0.091 kvar
Fundamental Current (max)	22.38 A	THD (max)	0.20 %

Order	Limit1[A rms]	Limit2[A rms]	Ave[A rms]	Max[A rms]	LimitOver[s]	Judge
1	-----	-----	22.20	22.38	-----	N/A
2	1.0800	2.1600	0.00	0.00	0.0	N/A
3	2.3000	4.6000	0.01	0.01	0.0	N/A
4	0.4300	0.8600	0.00	0.00	0.0	N/A
5	1.1400	2.2800	0.00	0.01	0.0	N/A
6	0.3000	0.6000	0.00	0.00	0.0	N/A
7	0.7700	1.5400	0.01	0.01	0.0	N/A
8	0.2300	0.4600	0.01	0.01	0.0	N/A
9	0.4000	0.8000	0.01	0.01	0.0	N/A
10	0.1840	0.3680	0.00	0.01	0.0	N/A
11	0.3300	0.6600	0.01	0.01	0.0	N/A
12	0.1533	0.3067	0.00	0.00	0.0	N/A
13	0.2100	0.4200	0.01	0.01	0.0	N/A
14	0.1314	0.2629	0.00	0.00	0.0	N/A
15	0.1500	0.3000	0.00	0.01	0.0	N/A
16	0.1150	0.2300	0.00	0.00	0.0	N/A
17	0.1324	0.2647	0.00	0.01	0.0	N/A
18	0.1022	0.2044	0.00	0.00	0.0	N/A
19	0.1184	0.2368	0.01	0.01	0.0	N/A
20	0.0920	0.1840	0.00	0.00	0.0	N/A
21	0.1071	0.2143	0.00	0.00	0.0	N/A
22	0.0836	0.1673	0.00	0.00	0.0	N/A
23	0.0978	0.1957	0.01	0.01	0.0	N/A
24	0.0767	0.1533	0.00	0.00	0.0	N/A
25	0.0900	0.1800	0.01	0.01	0.0	N/A
26	0.0708	0.1415	0.00	0.00	0.0	N/A
27	0.0833	0.1667	0.00	0.00	0.0	N/A
28	0.0657	0.1314	0.00	0.00	0.0	N/A
29	0.0776	0.1552	0.01	0.01	0.0	N/A
30	0.0613	0.1227	0.00	0.00	0.0	N/A
31	0.0726	0.1452	0.01	0.01	0.0	N/A
32	0.0575	0.1150	0.00	0.00	0.0	N/A
33	0.0682	0.1364	0.00	0.00	0.0	N/A
34	0.0541	0.1082	0.00	0.00	0.0	N/A
35	0.0643	0.1286	0.00	0.01	0.0	N/A
36	0.0511	0.1022	0.00	0.00	0.0	N/A
37	0.0608	0.1216	0.01	0.01	0.0	N/A
38	0.0484	0.0968	0.00	0.00	0.0	N/A
39	0.0577	0.1154	0.00	0.00	0.0	N/A
40	0.0460	0.0920	0.00	0.00	0.0	N/A

N/A : Not Apply

*1 The value for power specified by the manufacturer.

*4 When the Edition 3.0 is applied, 200% of the Limit1 value is applied to each Limit2 value.



Unless otherwise agreed in writing, this document is issued by the Company subject to its General Conditions of Service printed overleaf, available on request or accessible at <http://www.sgs.com/en/Terms-and-Conditions.aspx> and, for electronic format documents, subject to Terms and Conditions for Electronic Documents at <http://www.sgs.com/en/Terms-and-Conditions/Terms-e-Documents.aspx>. Attention is drawn to the limitation of liability, indemnification and jurisdiction issues defined therein. Any holder of this document is advised that information contained hereon reflects the Company's findings at the time of its intervention only and within the limits of Client's instructions, if any. The Company's sole responsibility is to its Client and this document does not exonerate parties to a transaction from exercising all their rights and obligations under the transaction documents. This document cannot be reproduced except in full, without prior written approval of the Company. Any unauthorized alteration, forgery or falsification of the content or appearance of this document is unlawful and offenders may be prosecuted to the fullest extent of the law. Unless otherwise stated the results shown in this test report refer only to the sample(s) tested and such sample(s) are retained for 30 days only.

Test Data of L3 Harmonics Current

Voltage (max)	229.43 V	THC (max)	0.03 A
Current (max)	21.73 A	POHC (max) / Limit	0.02 A / ----- *4
Power (setting)	10.00 W *1	Apparent Power (max)	4.985 kVA
Power Factor (max)	0.9997	Reactive Power (max)	0.127 kvar
Fundamental Current (max)	21.73 A	THD (max)	0.18 %

Order	Limit1[A rms]	Limit2[A rms]	Ave[A rms]	Max[A rms]	LimitOver[s]	Judge
1	-----	-----	21.57	21.73	-----	N/A
2	1.0800	2.1600	0.00	0.00	0.0	N/A
3	2.3000	4.6000	0.00	0.00	0.0	N/A
4	0.4300	0.8600	0.00	0.00	0.0	N/A
5	1.1400	2.2800	0.00	0.00	0.0	N/A
6	0.3000	0.6000	0.00	0.00	0.0	N/A
7	0.7700	1.5400	0.01	0.01	0.0	N/A
8	0.2300	0.4600	0.00	0.01	0.0	N/A
9	0.4000	0.8000	0.01	0.01	0.0	N/A
10	0.1840	0.3680	0.00	0.01	0.0	N/A
11	0.3300	0.6600	0.01	0.01	0.0	N/A
12	0.1533	0.3067	0.00	0.00	0.0	N/A
13	0.2100	0.4200	0.01	0.01	0.0	N/A
14	0.1314	0.2629	0.00	0.00	0.0	N/A
15	0.1500	0.3000	0.00	0.00	0.0	N/A
16	0.1150	0.2300	0.00	0.00	0.0	N/A
17	0.1324	0.2647	0.01	0.01	0.0	N/A
18	0.1022	0.2044	0.00	0.00	0.0	N/A
19	0.1184	0.2368	0.01	0.01	0.0	N/A
20	0.0920	0.1840	0.00	0.00	0.0	N/A
21	0.1071	0.2143	0.00	0.00	0.0	N/A
22	0.0836	0.1673	0.00	0.00	0.0	N/A
23	0.0978	0.1957	0.01	0.01	0.0	N/A
24	0.0767	0.1533	0.00	0.00	0.0	N/A
25	0.0900	0.1800	0.01	0.01	0.0	N/A
26	0.0708	0.1415	0.00	0.00	0.0	N/A
27	0.0833	0.1667	0.00	0.00	0.0	N/A
28	0.0657	0.1314	0.00	0.00	0.0	N/A
29	0.0776	0.1552	0.01	0.01	0.0	N/A
30	0.0613	0.1227	0.00	0.00	0.0	N/A
31	0.0726	0.1452	0.01	0.01	0.0	N/A
32	0.0575	0.1150	0.00	0.00	0.0	N/A
33	0.0682	0.1364	0.00	0.00	0.0	N/A
34	0.0541	0.1082	0.00	0.00	0.0	N/A
35	0.0643	0.1286	0.01	0.01	0.0	N/A
36	0.0511	0.1022	0.00	0.00	0.0	N/A
37	0.0608	0.1216	0.00	0.01	0.0	N/A
38	0.0484	0.0968	0.00	0.00	0.0	N/A
39	0.0577	0.1154	0.00	0.00	0.0	N/A
40	0.0460	0.0920	0.00	0.00	0.0	N/A

N/A : Not Apply

*1 The value for power specified by the manufacturer.

*4 When the Edition 3.0 is applied, 200% of the Limit1 value is applied to each Limit2 value.



Unless otherwise agreed in writing, this document is issued by the Company subject to its General Conditions of Service printed overleaf, available on request or accessible at <http://www.sgs.com/en/Terms-and-Conditions.aspx> and, for electronic format documents, subject to Terms and Conditions for Electronic Documents at <http://www.sgs.com/en/Terms-and-Conditions/Terms-e-Documents.aspx>. Attention is drawn to the limitation of liability, indemnification and jurisdiction issues defined therein. Any holder of this document is advised that information contained hereon reflects the Company's findings at the time of its intervention only and within the limits of Client's instructions, if any. The Company's sole responsibility is to its Client and this document does not exonerate parties to a transaction from exercising all their rights and obligations under the transaction documents. This document cannot be reproduced except in full, without prior written approval of the Company. Any unauthorized alteration, forgery or falsification of the content or appearance of this document is unlawful and offenders may be prosecuted to the fullest extent of the law. Unless otherwise stated the results shown in this test report refer only to the sample(s) tested and such sample(s) are retained for 30 days only.

Attention: To check the authenticity of testing /inspection report & certificate, please contact us at telephone: (86-755) 8307 1443, or email: CN.Doccheck@sgs.com

6.4 Voltage Fluctuations and Flicker

Test Requirement: EN IEC 61000-6-3: 2021
 Test Method: EN IEC 61000-3-11: 2019

6.4.1 E.U.T. Operation

Operating Environment:
 Temperature: 22.1 °C Humidity: 57.3 % RH Atmospheric Pressure: 1010 mbar

6.4.2 Test Mode Description

Pre-scan / Final test	Mode Code	Description
Final test	00	Charging Mode.

6.4.3 Test Setup Diagram

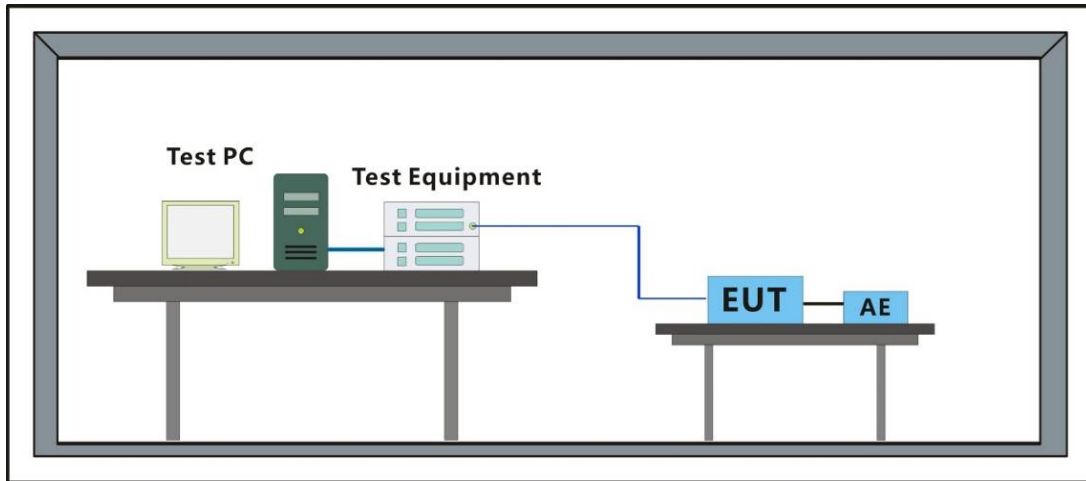

6.4.4 Measurement Procedure and Data



SGS-CSTC Standards Technical Services Co., Ltd. Shenzhen Branch

SZEMC-TRF-01 Rev. A/0 Aug01,2022

Report No.: SZEM221100776001

Page: 32 of 50

Test Mode: 00;

Wiring Method	3-Phase 4-Wire	Pst Measurement Time	600 s
Nominal Voltage	230.0 V	Pst Measurement Count	1
Nominal Frequency	50.0 Hz	Flicker Margin	100 %
		d Measurement Margin	100 %
		Z test	Ra test 0.15 ohm
			Xa test 0.15 ohm
			Rn test 0.10 ohm
			Xn test 0.10 ohm

Judgment	
Final Test Result	Pass
L1 Test Result	Pass
L2 Test Result	Pass
L3 Test Result	Pass



Setting List

Items	Contents		
Limitation Standard	IEC 61000-3-11 Ed1.0		
Measurement Technic	IEC 61000-4-15 Ed2.0 (2010)		
Voltage Range	L1 600V,	L2 600V,	L3 600V
Current Range	L1 40 A,	L1 40 A,	L1 40 A,
Nominal Voltage	230 V		
Nominal Frequency	50 Hz		
Wiring Method	3P4W		
PLL Source	Voltage L1		
Pst Measurement Time	10min 0s		
Pst Measurement Count	1		
dmax Limit Value	4 %		
Flicker Margin	100 %		
d Margin	100 %		
Judge Factor	Plt:Yes, Pst:Yes, dc:Yes, dmax:Yes, d(t)>3.3%:Yes		
Test Impedance Z test	0.15 ohm + jn0.15 ohm (3P)		
Test Impedance Ra test, Xa test	---		
Test Impedance Rn test, Xn test	---		
Current Input Terminal	L1 BNC,	L2 BNC,	L3 BNC
Reference Impedance	Use		
Reference Impedance Value	Z3		



7 Immunity Test Results

Performance Criteria Description in EN IEC 61000-6-1:2019

Criterion A

The EUT shall continue to operate as intended during and after the test. No degradation of performance or loss of function is allowed below a performance level specified by the manufacturer, when the EUT is used as intended. If the performance level is not specified by the manufacturer, this may be derived from the product description and documentation and what the user may reasonably expect from the equipment if used as intended.

Criterion B

The EUT shall continue to operate as intended after the test. No degradation of performance or loss of function is allowed below a performance level specified by the manufacturer, when the EUT is used as intended. The performance level may be replaced by a permissible loss of performance. However, during the test degradation of performance is allowed but no change of actual operating state or stored data is allowed. If the minimum performance level or the permissible performance loss is not specified by the manufacturer, either of these may be derived from the product description and documentation and what the user may reasonably expect from the equipment if used as intended.

Criterion C

Temporary loss of function is allowed during the test, provided the function is self-recoverable or can be restored by the operation of the controls.



7.1 Conducted Immunity at AC Mains Power Port (150kHz-80MHz)

Test Requirement: EN IEC 61000-6-1: 2019
 Test Method: EN 61000-4-6:2014

7.1.1 Test Setup Diagram

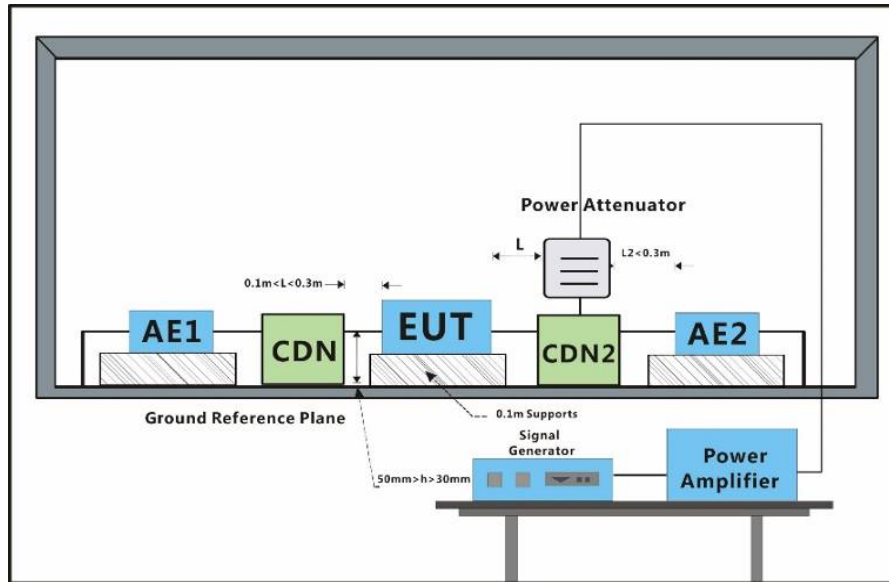

7.1.2 E.U.T. Operation

Operating Environment:
 Temperature: 21.7 °C Humidity: 56.6 % RH Atmospheric Pressure: 1010 mbar

7.1.3 Test Mode Description

Pre-scan / Final test	Mode Code	Description
Final test	00	Charging Mode.

7.1.4 Test Condition and Results:

Performance Criterion: A
 Frequency Range: 0.15MHz to 80MHz
 Modulation: 80%, 1kHz Amplitude Modulation
 Step Size: 1%

Cable port	Level (Vrms)	CDN/Clamp	Dwell time	Result / Observations
AC power port	3	CDN	3s	A

A: No degradation in the performance of the EUT was observed



Unless otherwise agreed in writing, this document is issued by the Company subject to its General Conditions of Service printed overleaf, available on request or accessible at <http://www.sgs.com/en/Terms-and-Conditions.aspx> and, for electronic format documents, subject to Terms and Conditions for Electronic Documents at <http://www.sgs.com/en/Terms-and-Conditions/Terms-e-Documents.aspx>. Attention is drawn to the limitation of liability, indemnification and jurisdiction issues defined therein. Any holder of this document is advised that information contained hereon reflects the Company's findings at the time of its intervention only and within the limits of Client's instructions, if any. The Company's sole responsibility is to its Client and this document does not exonerate parties to a transaction from exercising all their rights and obligations under the transaction documents. This document cannot be reproduced except in full, without prior written approval of the Company. Any unauthorized alteration, forgery or falsification of the content or appearance of this document is unlawful and offenders may be prosecuted to the fullest extent of the law. Unless otherwise stated the results shown in this test report refer only to the sample(s) tested and such sample(s) are retained for 30 days only.
 Attention: To check the authenticity of testing / inspection report & certificate, please contact us at telephone: (86-755) 8307 1443, or email: CN.Doccheck@sgs.com

7.2 Electrical Fast Transients Burst at AC Mains Power Port

Test Requirement: EN IEC 61000-6-1: 2019
 Test Method: EN 61000-4-4:2012

7.2.1 Test Setup Diagram

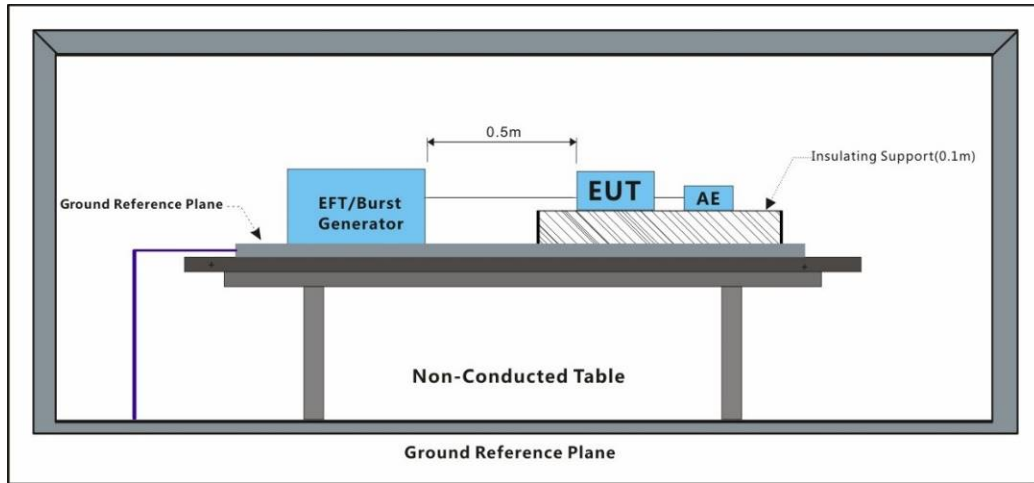

7.2.2 E.U.T. Operation

Operating Environment:
 Temperature: 21.7 °C Humidity: 56.6 % RH Atmospheric Pressure: 1010 mbar

7.2.3 Test Mode Description

Pre-scan / Final test	Mode Code	Description
Final test	00	Charging Mode.

7.2.4 Test Condition and Results:

Performance Criterion: B
 Repetition Frequency: 5kHz or 100kHz
 Burst Period: 300ms
 Test Duration: 2 minute per level & polarity

Test Line	Level (kV)	Polarity	CDN/Clamp	Result / Observations
AC power port	1	+	CDN	A
AC power port	1	-	CDN	A

A: No degradation in the performance of the EUT was observed



7.3 Electrostatic Discharge

Test Requirement: EN IEC 61000-6-1: 2019
 Test Method: EN 61000-4-2:2009

7.3.1 Test Setup Diagram

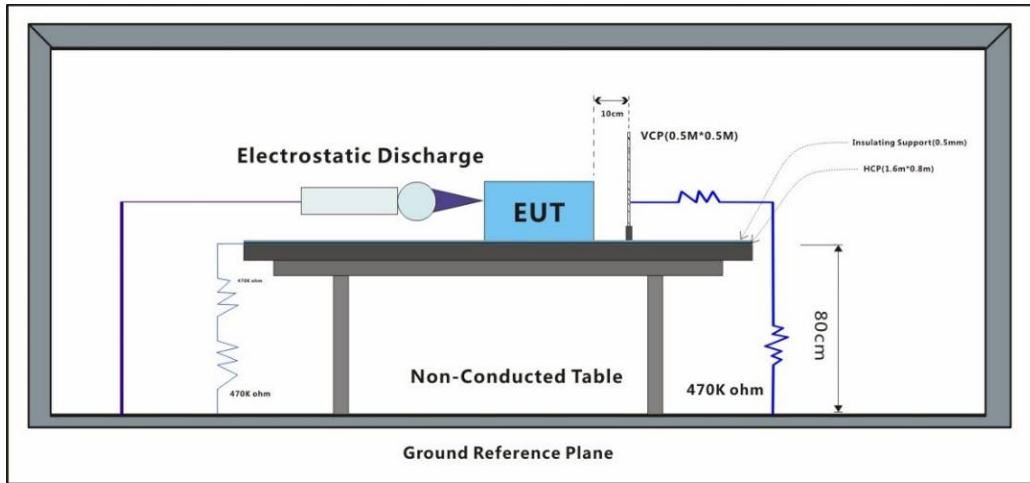

7.3.2 E.U.T. Operation

Operating Environment:
 Temperature: 18.9 °C Humidity: 50.4 % RH Atmospheric Pressure: 1010 mbar

7.3.3 Test Mode Description

Pre-scan / Final test	Mode Code	Description
Final test	00	Charging Mode.
Final test	01	Discharging Mode.

7.3.4 Test Condition and Results:

Performance Criterion: B
 Discharge Impedance: 330Ω/150pF
 Number of Discharge: Minimum 10 times at each test point
 Discharge Mode: Single Discharge
 Discharge Period: 1 second minimum
 Test Point: 1. All insulated enclosure and seams.
 2. All accessible metal parts of the enclosure.
 3. All side



SGS-CSTC Standards Technical Services Co., Ltd. Shenzhen Branch

SZEMC-TRF-01 Rev. A/0 Aug01,2022

Report No.: SZEM221100776001

Page: 38 of 50

Discharge type	Level (kV)	Polarity	Test Point	Result / Observations
Air Discharge	2,4,8	+	1	A
Air Discharge	2,4,8	-	1	A
Contact Discharge	4	+	2	A
Contact Discharge	4	-	2	A
Horizontal Coupling	4	+	3	A
Horizontal Coupling	4	-	3	A
Vertical Coupling	4	+	3	A
Vertical Coupling	4	-	3	A

A: No degradation in the performance of the EUT was observed



Unless otherwise agreed in writing, this document is issued by the Company subject to its General Conditions of Service printed overleaf, available on request or accessible at <http://www.sgs.com/en/Terms-and-Conditions.aspx> and, for electronic format documents, subject to Terms and Conditions for Electronic Documents at <http://www.sgs.com/en/Terms-and-Conditions/Terms-e-Document.aspx>. Attention is drawn to the limitation of liability, indemnification and jurisdiction issues defined therein. Any holder of this document is advised that information contained hereon reflects the Company's findings at the time of its intervention only and within the limits of Client's instructions, if any. The Company's sole responsibility is to its Client and this document does not exonerate parties to a transaction from exercising all their rights and obligations under the transaction documents. This document cannot be reproduced except in full, without prior written approval of the Company. Any unauthorized alteration, forgery or falsification of the content or appearance of this document is unlawful and offenders may be prosecuted to the fullest extent of the law. Unless otherwise stated the results shown in this test report refer only to the sample(s) tested and such sample(s) are retained for 30 days only. Attention: To check the authenticity of testing / inspection report & certificate, please contact us at telephone: (86-755) 8307 1443, or email: CN.Doccheck@sgs.com

7.4 Radiated Immunity (80MHz-6GHz)

Test Requirement: EN IEC 61000-6-1: 2019
 Test Method: EN IEC 61000-4-3: 2020

7.4.1 Test Setup Diagram

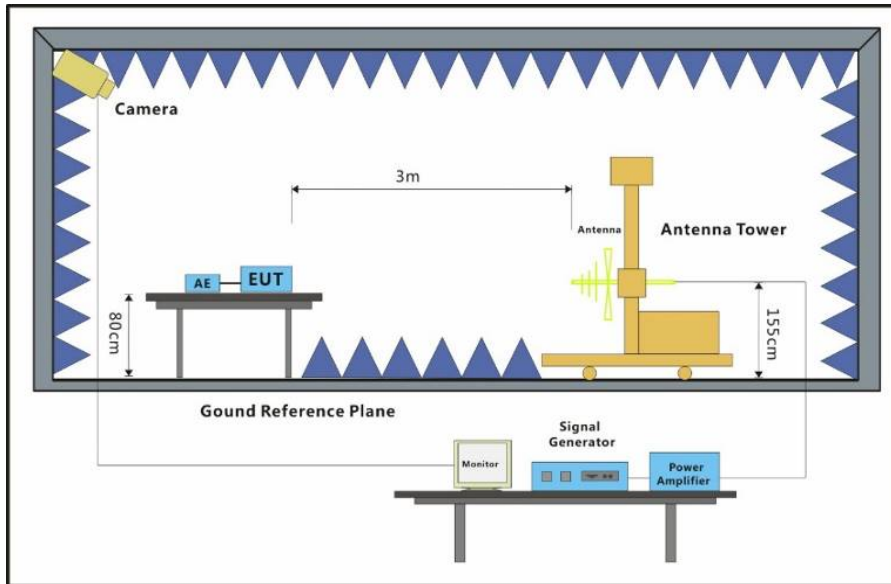

7.4.2 E.U.T. Operation

Operating Environment:
 Temperature: 24 °C Humidity: 48 % RH Atmospheric Pressure: 1010 mbar

7.4.3 Test Mode Description

Pre-scan / Final test	Mode Code	Description
Final test	00	Charging Mode.
Final test	01	Discharging Mode.

7.4.4 Test Condition and Results:

Performance Criterion:A
 Antenna Polarisation:Vertical and Horizontal
 Modulation:1kHz,80% Amp. Mod,1% increment
 Frequency Range:80MHz to 1GHz, 1.4GHz to 6GHz



SGS-CSTC Standards Technical Services Co., Ltd. Shenzhen Branch

SZEMC-TRF-01 Rev. A/0 Aug01,2022

Report No.: SZEM221100776001

Page: 40 of 50

Frequency	Level (V/m)	EUT Face	Dwell time	Result / Observations
80MHz-1GHz	3	Front	3s	A
80MHz-1GHz	3	Back	3s	A
80MHz-1GHz	3	Left	3s	A
80MHz-1GHz	3	Right	3s	A
80MHz-1GHz	3	Top	3s	A
80MHz-1GHz	3	Underside	3s	A
1.4GHz-6GHz	3	Front	3s	A
1.4GHz-6GHz	3	Back	3s	A
1.4GHz-6GHz	3	Left	3s	A
1.4GHz-6GHz	3	Right	3s	A
1.4GHz-6GHz	3	Top	3s	A
1.4GHz-6GHz	3	Underside	3s	A

A: No degradation in the performance of the EUT was observed



SGS-CSTC Standards Technical Services Co., Ltd.
Shenzhen Branch

Unless otherwise agreed in writing, this document is issued by the Company subject to its General Conditions of Service printed overleaf, available on request or accessible at <http://www.sgs.com/en/Terms-and-Conditions.aspx> and, for electronic format documents, subject to Terms and Conditions for Electronic Documents at <http://www.sgs.com/en/Terms-and-Conditions/Terms-e-Documents.aspx>. Attention is drawn to the limitation of liability, indemnification and jurisdiction issues defined therein. Any holder of this document is advised that information contained hereon reflects the Company's findings at the time of its intervention only and within the limits of Client's instructions, if any. The Company's sole responsibility is to its Client and this document does not exonerate parties to a transaction from exercising all their rights and obligations under the transaction documents. This document cannot be reproduced except in full, without prior written approval of the Company. Any unauthorized alteration, forgery or falsification of the content or appearance of this document is unlawful and offenders may be prosecuted to the fullest extent of the law. Unless otherwise stated the results shown in this test report refer only to the sample(s) tested and such sample(s) are retained for 30 days only.
Attention: To check the authenticity of testing / inspection report & certificate, please contact us at telephone: (86-755) 8307 1443, or email: CN.Doccheck@sgs.com

No.1 Workshop, M-10, Middle Section, Science & Technology Park, Shenzhen, China 518057 t (86-755) 26012053 f (86-755) 26710594 www.sgs.com.cn
中国·深圳·科技园中区M-10栋一号厂房 邮编: 518057 t (86-755) 26012053 f (86-755) 26710594 sgs.china@sgs.com

7.5 Surge at AC Mains Power Port

Test Requirement: EN IEC 61000-6-1: 2019

Test Method: EN 61000-4-5:2014+A1:2017

7.5.1 Test Setup Diagram

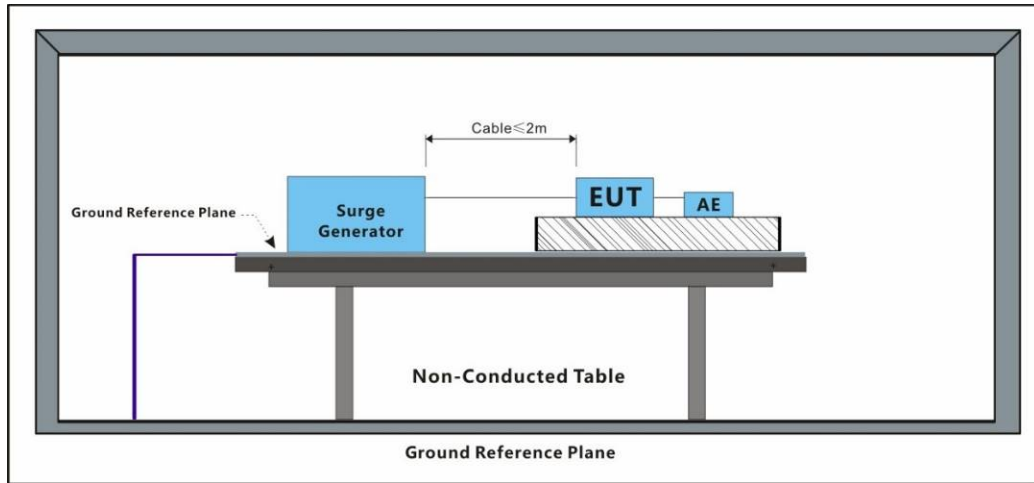

7.5.2 E.U.T. Operation

Operating Environment:

Temperature: 21.7 °C Humidity: 56.6 % RH Atmospheric Pressure: 1010 mbar

7.5.3 Test Mode Description

Pre-scan / Final test	Mode Code	Description
Final test	00	Charging Mode.

7.5.4 Test Condition and Results:

Performance Criterion: B

Interval: 60s between each surge

No. of surges: 5 positive, 5 negative at 0°, 90°, 180°, 270°.



SGS-CSTC Standards Technical Services Co., Ltd. Shenzhen Branch

SZEMC-TRF-01 Rev. A/0 Aug01,2022

Report No.: SZEM221100776001

Page: 42 of 50

Test Line	Level (kV)	Polarity	Phase (deg)	Result / Observations
L-N	1	+	0°	A
L-N	1	-	0°	A
L-N	1	+	90°	A
L-N	1	-	90°	A
L-N	1	+	180°	A
L-N	1	-	180°	A
L-N	1	+	270°	A
L-N	1	-	270°	A
L-PE	2	+	0°	A
L-PE	2	-	0°	A
L-PE	2	+	90°	A
L-PE	2	-	90°	A
L-PE	2	+	180°	A
L-PE	2	-	180°	A
L-PE	2	+	270°	A
L-PE	2	-	270°	A
N-PE	2	+	0°	A
N-PE	2	-	0°	A
N-PE	2	+	90°	A
N-PE	2	-	90°	A
N-PE	2	+	180°	A
N-PE	2	-	180°	A
N-PE	2	+	270°	A
N-PE	2	-	270°	A

A: No degradation in the performance of the EUT was observed



SGS-CSTC Standards Technical Services Co., Ltd.
Shenzhen Branch

Unless otherwise agreed in writing, this document is issued by the Company subject to its General Conditions of Service printed overleaf, available on request or accessible at <http://www.sgs.com/en/Terms-and-Conditions.aspx> and, for electronic format documents, subject to Terms and Conditions for Electronic Documents at <http://www.sgs.com/en/Terms-and-Conditions/Terms-e-Documents.aspx>. Attention is drawn to the limitation of liability, indemnification and jurisdiction issues defined therein. Any holder of this document is advised that information contained hereon reflects the Company's findings at the time of its intervention only and within the limits of Client's instructions, if any. The Company's sole responsibility is to its Client and this document does not exonerate parties to a transaction from exercising all their rights and obligations under the transaction documents. This document cannot be reproduced except in full, without prior written approval of the Company. Any unauthorized alteration, forgery or falsification of the content or appearance of this document is unlawful and offenders may be prosecuted to the fullest extent of the law. Unless otherwise stated the results shown in this test report refer only to the sample(s) tested and such sample(s) are retained for 30 days only.
Attention: To check the authenticity of testing / inspection report & certificate, please contact us at telephone: (86-755) 8307 1443, or email: CN.Doccheck@sgs.com

No.1 Workshop, M-10, Middle Section, Science & Technology Park, Shenzhen, China 518057 t (86-755) 26012053 f (86-755) 26710594 www.sgs.com.cn
中国·深圳·科技园中区M-10栋一号厂房 邮编: 518057 t (86-755) 26012053 f (86-755) 26710594 sgs.china@sgs.com

7.6 Voltage Dips and Interruptions

Test Requirement: EN IEC 61000-6-1: 2019
 Test Method: EN IEC 61000-4-11:2020

7.6.1 Test Setup Diagram

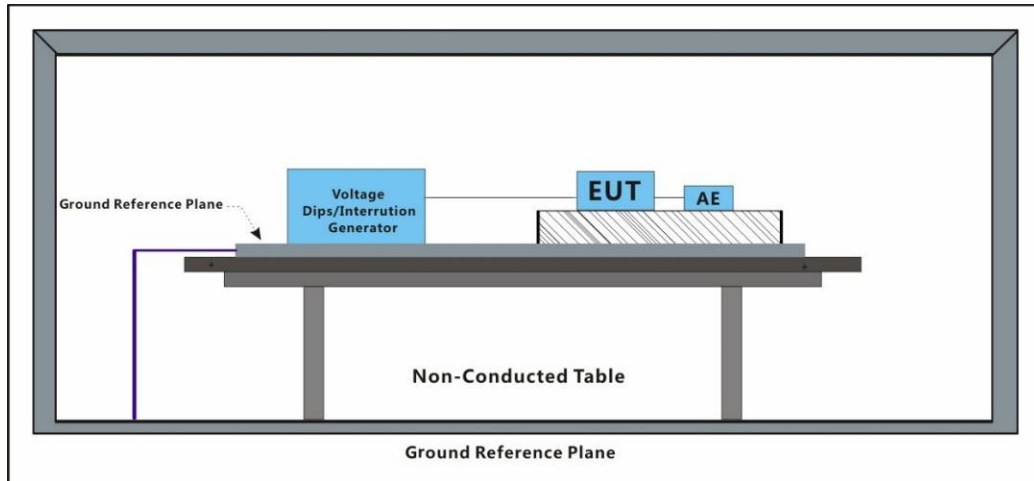

7.6.2 E.U.T. Operation

Operating Environment:
 Temperature: 21.7 °C Humidity: 56.6 % RH Atmospheric Pressure: 1010 mbar

7.6.3 Test Mode Description

Pre-scan / Final test	Mode Code	Description
Final test	00	Charging Mode.

7.6.4 Test Condition and Results:

Performance Criterion:
 0% of UT (Supply Voltage) for 0.5 Cycle:B;
 0% of UT for 1 Cycle:B;
 0% of UT for 250 Cycles:C;
 70% of UT for 25 Cycles:C;
 No. of Dips / Interruptions: 3 per Level
 Time between dropout 10s



Unless otherwise agreed in writing, this document is issued by the Company subject to its General Conditions of Service printed overleaf, available on request or accessible at <http://www.sgs.com/en/Terms-and-Conditions.aspx> and, for electronic format documents, subject to Terms and Conditions for Electronic Documents at <http://www.sgs.com/en/Terms-and-Conditions/Terms-e-Documents.aspx>. Attention is drawn to the limitation of liability, indemnification and jurisdiction issues defined therein. Any holder of this document is advised that information contained hereon reflects the Company's findings at the time of its intervention only and within the limits of Client's instructions, if any. The Company's sole responsibility is to its Client and this document does not exonerate parties to a transaction from exercising all their rights and obligations under the transaction documents. This document cannot be reproduced except in full, without prior written approval of the Company. Any unauthorized alteration, forgery or falsification of the content or appearance of this document is unlawful and offenders may be prosecuted to the fullest extent of the law. Unless otherwise stated the results shown in this test report refer only to the sample(s) tested and such sample(s) are retained for 30 days only.
 Attention: To check the authenticity of testing / inspection report & certificate, please contact us at telephone: (86-755) 8307 1443, or email: CN.Doccheck@sgs.com

SGS-CSTC Standards Technical Services Co., Ltd. Shenzhen Branch

SZEMC-TRF-01 Rev. A/0 Aug01,2022

Report No.: SZEM221100776001

Page: 44 of 50

Level % UT	Phase (deg)	Duration	No. of Dips / Interruptions	Result / Observations
0	0°	0.5 Cycles	3	A
0	180°	0.5 Cycles	3	A
0	0°	1 Cycles	3	A
0	180°	1 Cycles	3	A
70	0°	25 Cycles	3	A
70	180°	25 Cycles	3	A
0	0°	250 Cycles	3	C
0	180°	250 Cycles	3	C

A: No degradation in the performance of the EUT was observed

C: During the test EUT stop working when power supply drop, after the test by manual operation can work normally.



SGS-CSTC Standards Technical Services Co., Ltd.
Shenzhen Branch

Unless otherwise agreed in writing, this document is issued by the Company subject to its General Conditions of Service printed overleaf, available on request or accessible at <http://www.sgs.com/en/Terms-and-Conditions.aspx> and, for electronic format documents, subject to Terms and Conditions for Electronic Documents at <http://www.sgs.com/en/Terms-and-Conditions/Terms-e-Documents.aspx>. Attention is drawn to the limitation of liability, indemnification and jurisdiction issues defined therein. Any holder of this document is advised that information contained hereon reflects the Company's findings at the time of its intervention only and within the limits of Client's instructions, if any. The Company's sole responsibility is to its Client and this document does not exonerate parties to a transaction from exercising all their rights and obligations under the transaction documents. This document cannot be reproduced except in full, without prior written approval of the Company. Any unauthorized alteration, forgery or falsification of the content or appearance of this document is unlawful and offenders may be prosecuted to the fullest extent of the law. Unless otherwise stated the results shown in this test report refer only to the sample(s) tested and such sample(s) are retained for 30 days only.
Attention: To check the authenticity of testing / inspection report & certificate, please contact us at telephone: (86-755) 8307 1443, or email: CN.Doccheck@sgs.com

No.1 Workshop, M-10, Middle Section, Science & Technology Park, Shenzhen, China 518057 t (86-755) 26012053 f (86-755) 26710594 www.sgs.com.cn
中国·深圳·科技园中区M-10栋一号厂房 邮编: 518057 t (86-755) 26012053 f (86-755) 26710594 sgs.china@sgs.com

8 Test Setup Photo

Conducted Emissions at AC Mains Power Port (150kHz-30MHz)

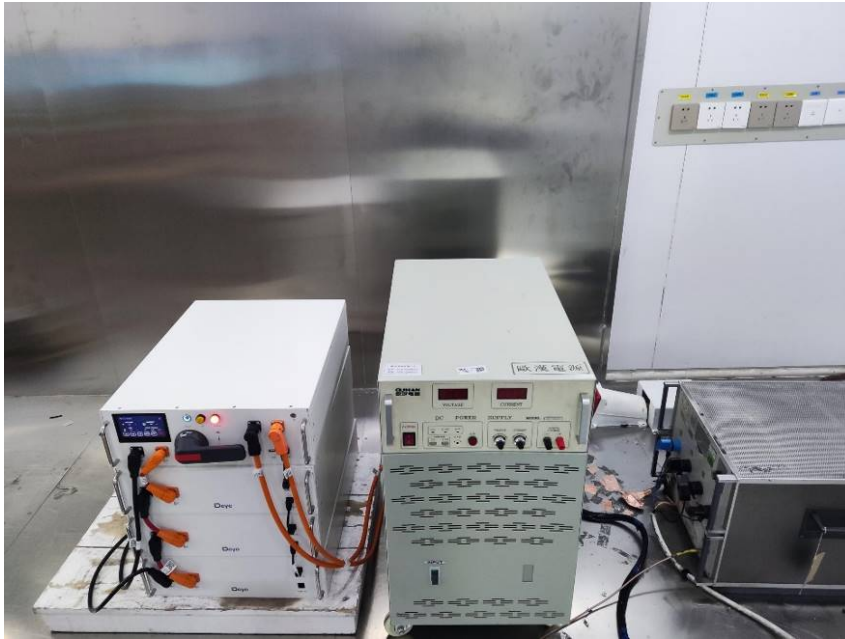

Radiated Emissions (30MHz-1GHz)

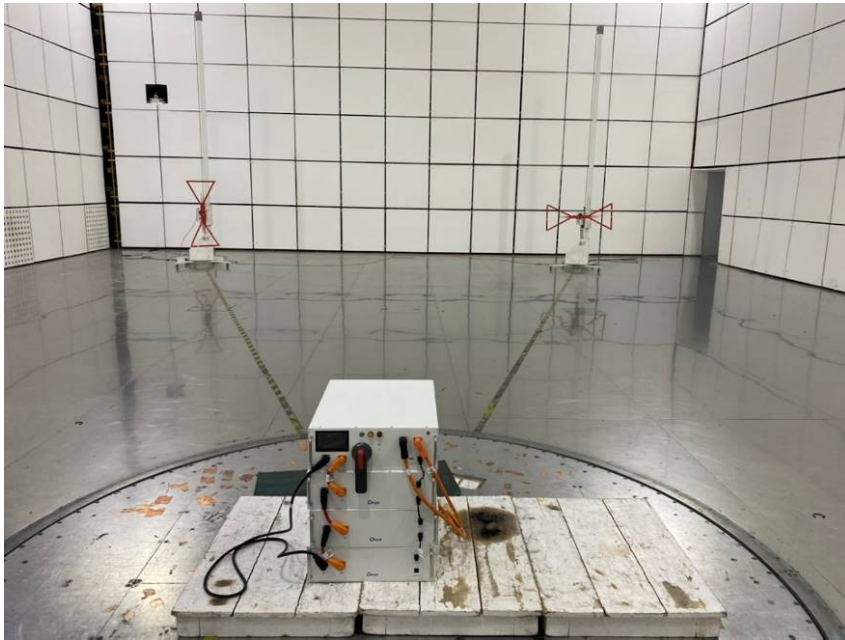

Unless otherwise agreed in writing, this document is issued by the Company subject to its General Conditions of Service printed overleaf, available on request or accessible at <http://www.sgs.com/en/Terms-and-Conditions.aspx> and, for electronic format documents, subject to Terms and Conditions for Electronic Documents at <http://www.sgs.com/en/Terms-and-Conditions/Terms-e-Documents.aspx>. Attention is drawn to the limitation of liability, indemnification and jurisdiction issues defined therein. Any holder of this document is advised that information contained hereon reflects the Company's findings at the time of its intervention only and within the limits of Client's instructions, if any. The Company's sole responsibility is to its Client and this document does not exonerate parties to a transaction from exercising all their rights and obligations under the transaction documents. This document cannot be reproduced except in full, without prior written approval of the Company. Any unauthorized alteration, forgery or falsification of the content or appearance of this document is unlawful and offenders may be prosecuted to the fullest extent of the law. Unless otherwise stated the results shown in this test report refer only to the sample(s) tested and such sample(s) are retained for 30 days only.

Attention: To check the authenticity of testing / inspection report & certificate, please contact us at telephone: (86-755) 8307 1443, or email: CN.Doccheck@sgs.com
 No.1 Workshop, M-10, Middle Section, Science & Technology Park, Shenzhen, China 518057 t (86-755) 26012053 f (86-755) 26710594 www.sgs.com.cn
 中国·深圳·科技园中区M-10栋一号厂房 邮编: 518057 t (86-755) 26012053 f (86-755) 26710594 sgs.china@sgs.com

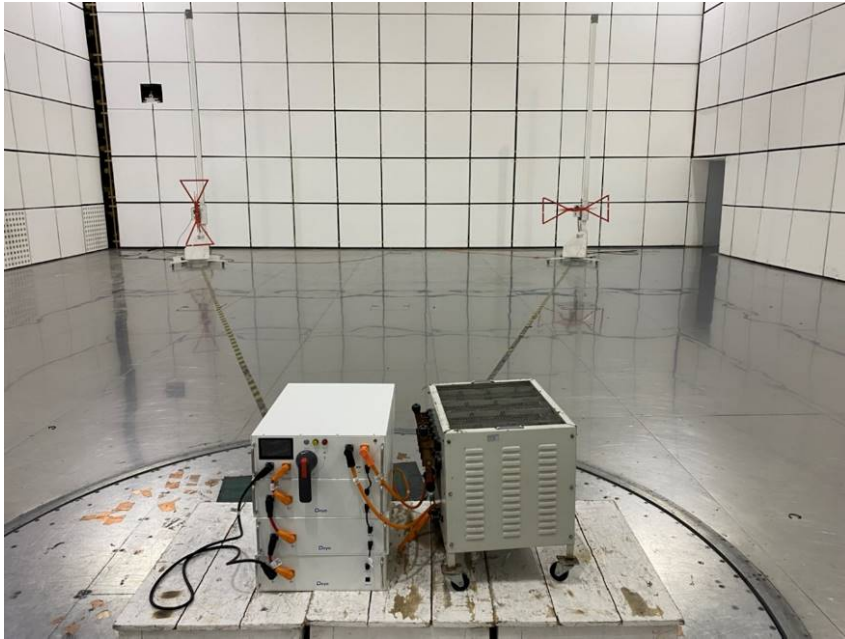

Harmonic Current Emission



Conducted Immunity at AC Mains Power Port (150kHz-80MHz)



Electrical Fast Transients Burst at AC Mains Power Port

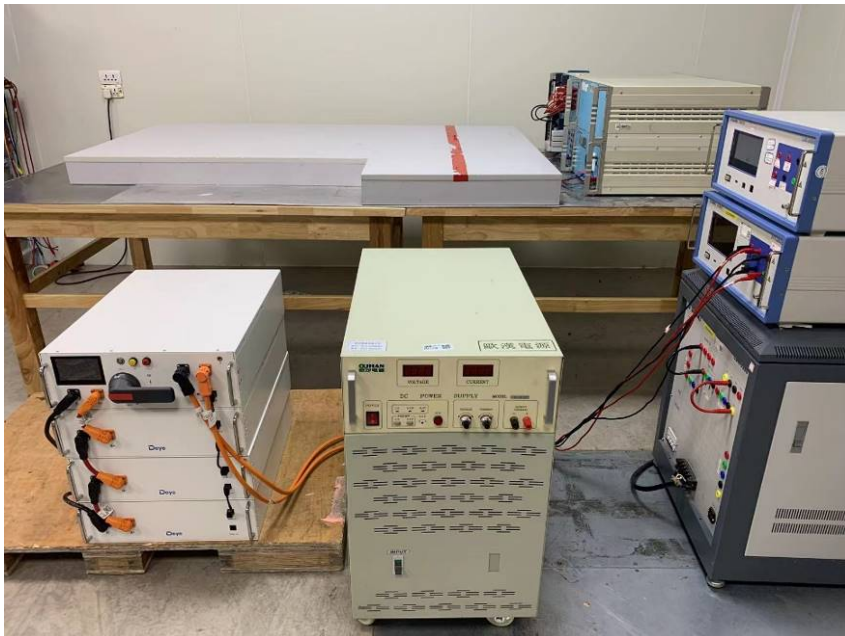

Unless otherwise agreed in writing, this document is issued by the Company subject to its General Conditions of Service printed overleaf, available on request or accessible at <http://www.sgs.com/en/Terms-and-Conditions.aspx> and, for electronic format documents, subject to Terms and Conditions for Electronic Documents at <http://www.sgs.com/en/Terms-and-Conditions/Terms-e-Document.aspx>. Attention is drawn to the limitation of liability, indemnification and jurisdiction issues defined therein. Any holder of this document is advised that information contained hereon reflects the Company's findings at the time of its intervention only and within the limits of Client's instructions, if any. The Company's sole responsibility is to its Client and this document does not exonerate parties to a transaction from exercising all their rights and obligations under the transaction documents. This document cannot be reproduced except in full, without prior written approval of the Company. Any unauthorized alteration, forgery or falsification of the content or appearance of this document is unlawful and offenders may be prosecuted to the fullest extent of the law. Unless otherwise stated the results shown in this test report refer only to the sample(s) tested and such sample(s) are retained for 30 days only.

Attention: To check the authenticity of testing /inspection report & certificate, please contact us at telephone: (86-755) 8307 1443, or email: CN.Doccheck@sgs.com

No.1 Workshop, M-10, Middle Section, Science & Technology Park, Shenzhen, China 518057 t (86-755) 26012053 f (86-755) 26710594 www.sgs.com.cn
 中国·深圳·科技园中区M-10栋一号厂房 邮编: 518057 t (86-755) 26012053 f (86-755) 26710594 sgs.china@sgs.com

Electrostatic Discharge



Radiated Immunity (80MHz-6GHz)

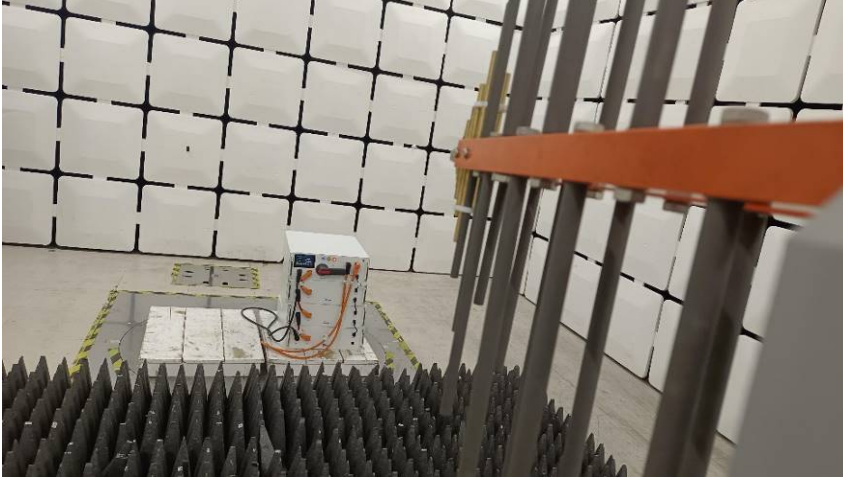

Surge at AC Mains Power Port

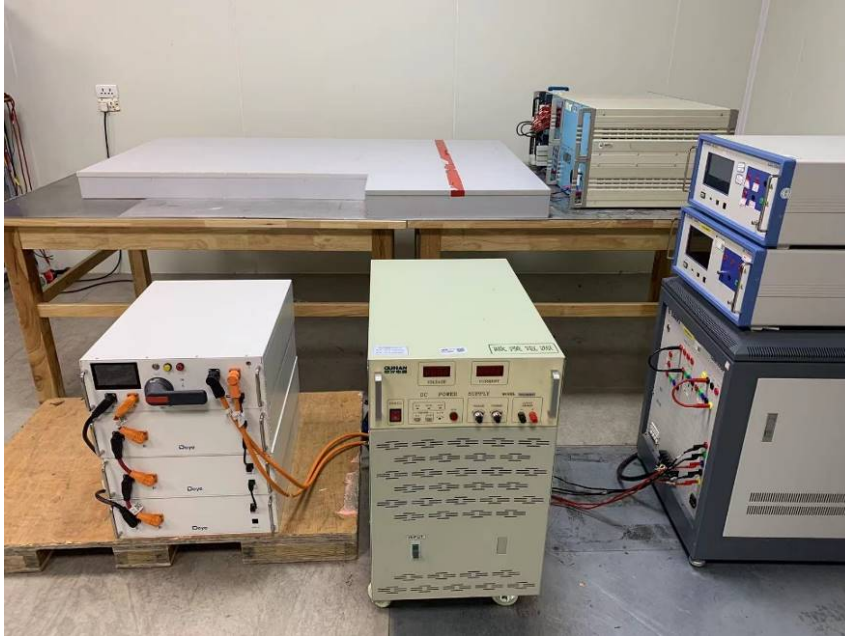

Voltage Dips and Interruptions



- End of the Report -

