





User manual

Model:R800 User manual



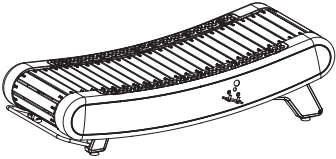
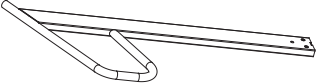
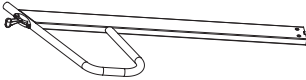
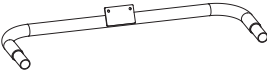



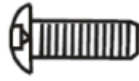

This product is planned and manufactured with safety in mind. Warranty applies only when used as instructed. Failure to comply with the warnings and precautions described in this document Please note that we assume no responsibility for any accidents resulting from use.

packing list

Parts name	Picturer view		qty	Note
Running area		pcs	1	
The left column		pcs	1	
The right column		pcs	1	
Display holder		pcs	1	
Digital display		pcs	1	
User manual		pcs	1	
Hardware package		bag	1	

Hardware package

No.	Parts Name	specification	Picture	qty
1	Hexagon socket screw with flat round head	M10×25		4
2	Hexagon socket screw with flat round head and half tooth	M10×50		4
3	Hexagon wrench	5MM		1
4	Hexagon wrench	6MM		1
5	Flat washer	φ10		8
6	Spring washer	φ10		8

Products view

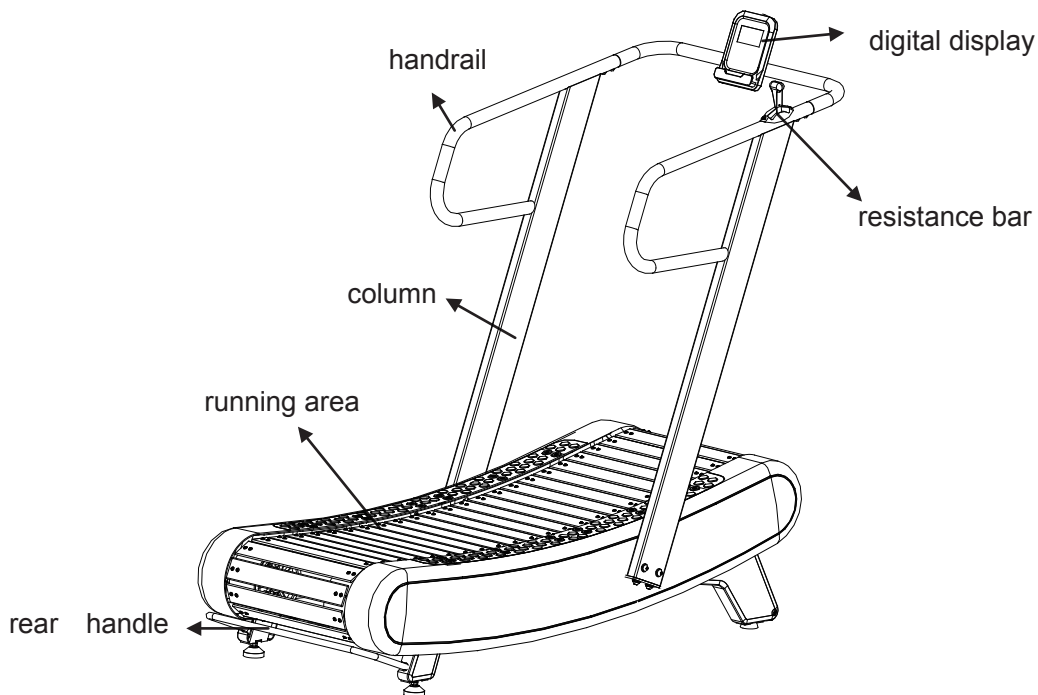

product installation

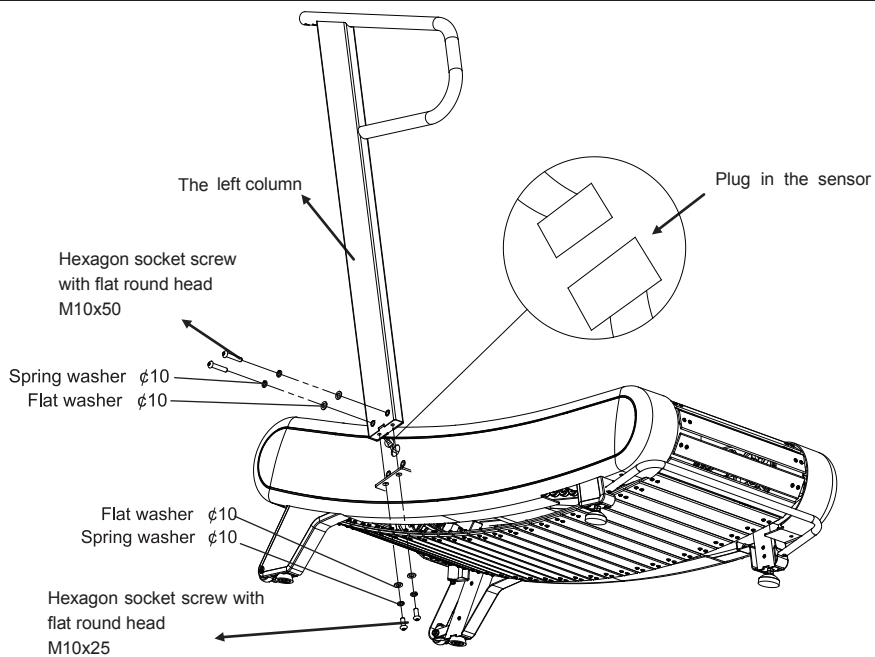

First step:

First the left column with two flat round head screw M10x25 and two inner hexagonal flat round head screw M10x50 respectively set on the spring washer $\phi 10$ ϕ peace gasket fixed on the run, as shown. Note 1. Should be out in the left column of induction line plug and ran out of induction line plug is good; 2. Don't lock screw mount after the first.

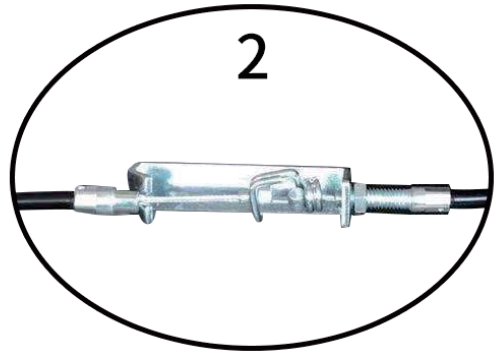
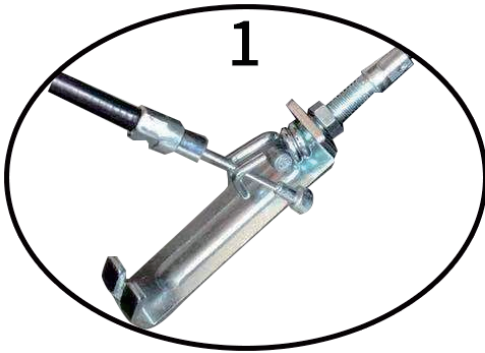

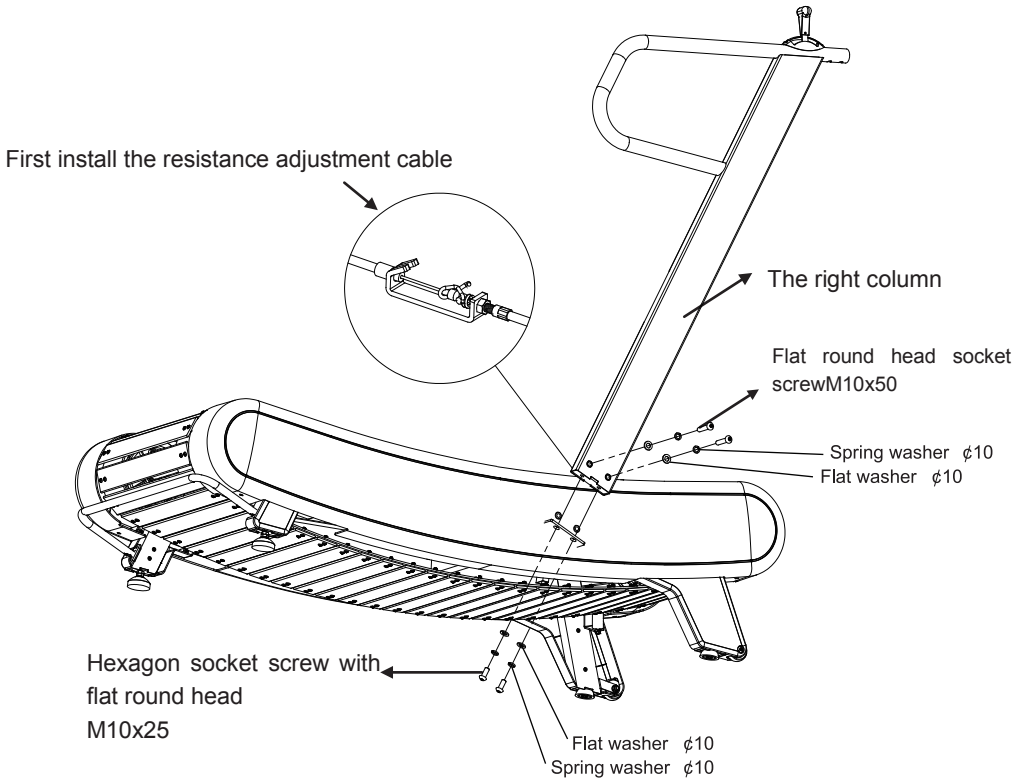

Second step:

the right column with two flat round head Screw M10x25 and two inner hexagonal flat round head screw M10x50 respectively set on the spring washer $\phi 10$ ϕ peace gasket Fixed on the run, as shown. Note 1. The right column Wire rope stretched out in the head and ran out of wire rope connected; Don't lock screw mount after the first.

Attention:

- 1:connecting the resistance cable (on from the right colu mn and one from the running deck)
- 2.do not lock the screws.

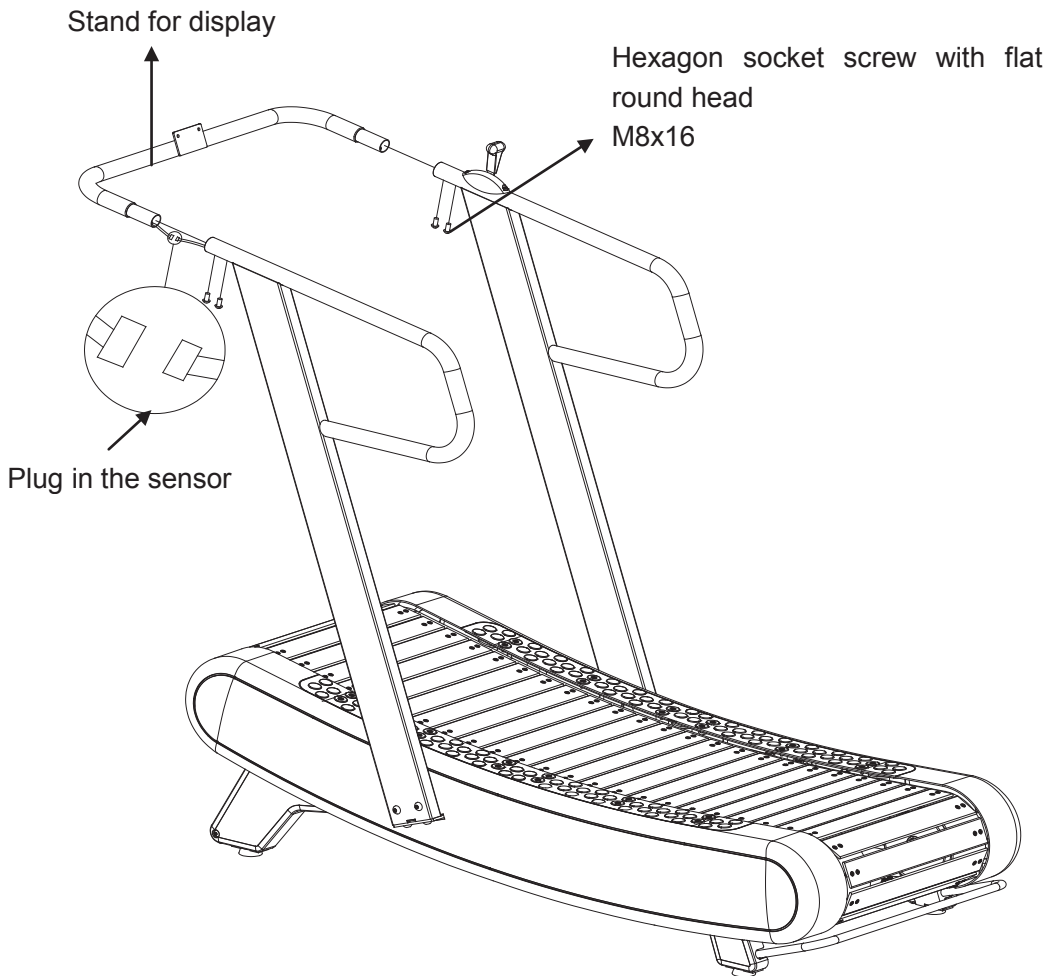

Third step:

Connecting the left and right connection frame with lift and right column, fixed with 4 pcs M8* 16 screws .(see the picture above)

Attention:

- 1:connecting the sensor by left connection frame and left side column.
- 2:do not lock the screws.

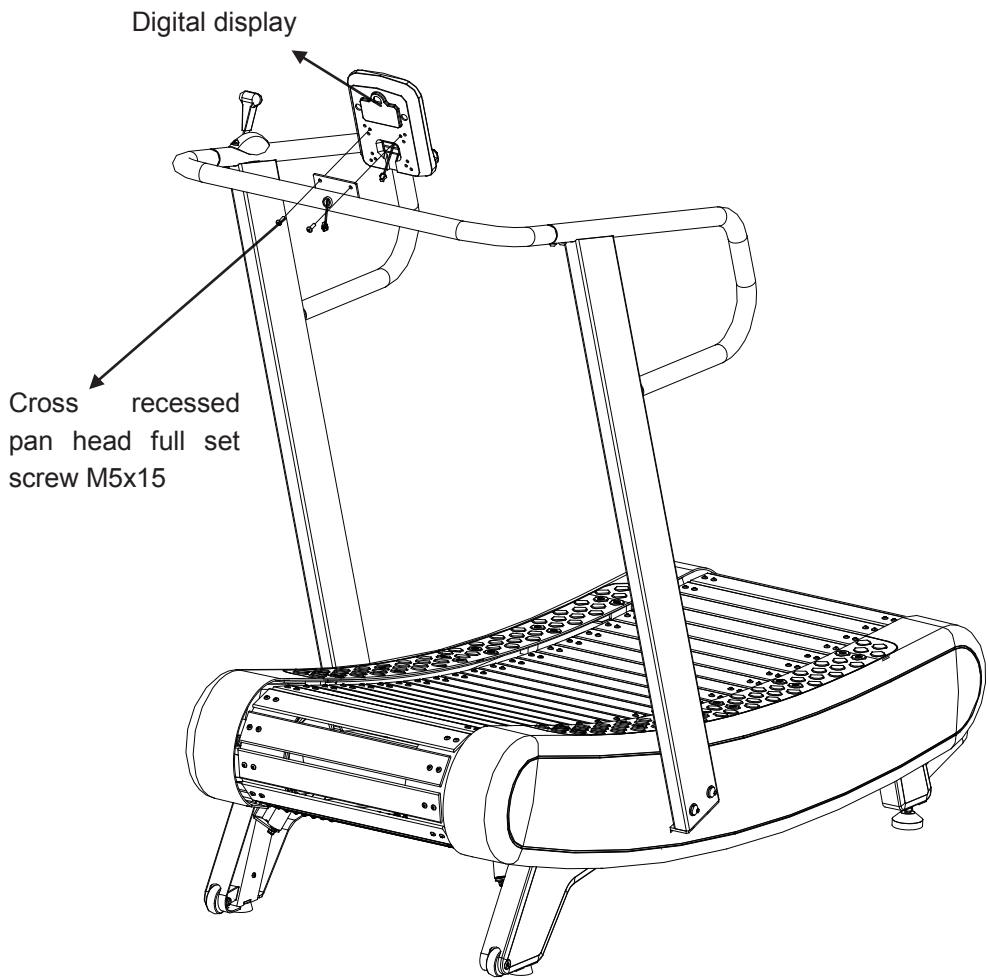

Fourth step:

Fixed the display stand on the right and left side Handrail.(connecting the sensor from left and right side connection frame,).

Fixed the screws by the above 3 steps.

Then fixed the digital display with 2 pcs M5*15 screw on the stand. then put the sensor in the speed jack. (see the picture above.).

The assembly is completely.

! Attention:

Put the dry battery on the monitor



Use a positive screwdriver to install the monitor in the center of the stand and fix it with screws.

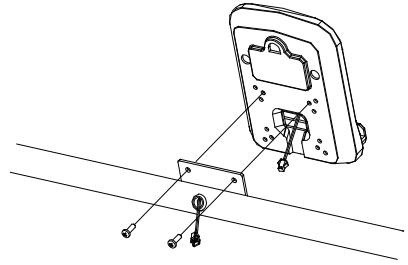

Connect the monitor plug to the jack on the back of the monitor

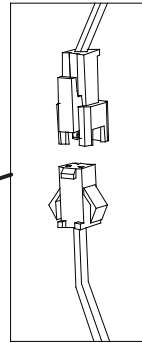
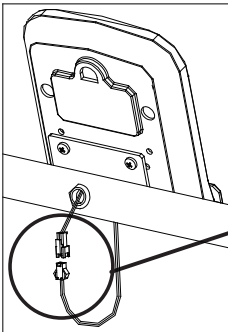

Please connect to the jack marked with [Speed]

The display is fixed to the watch holder with two cross slot disk head full tooth screws M5x15, and then the induction wire plug stretched out in the watch holder is inserted into the speed Jack on the back of the electronic watch, as shown in the figure, so that the installation is completed.



Directions for use

In order not to let your legs come out of the picture, please walk slowly. Adjust the speed slowly until you get used to it.

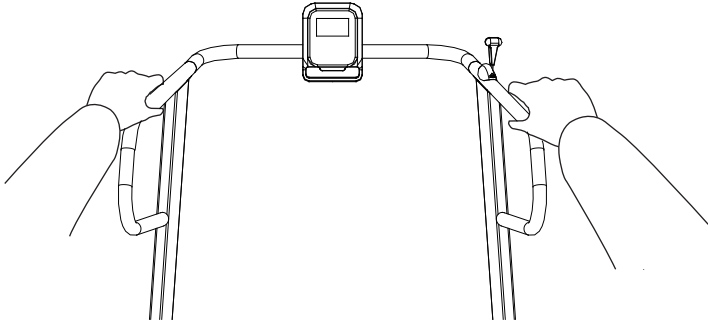
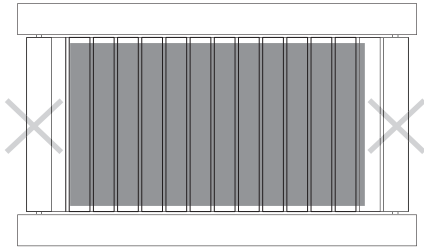

The available range of the steering wheel is shown in the figure.

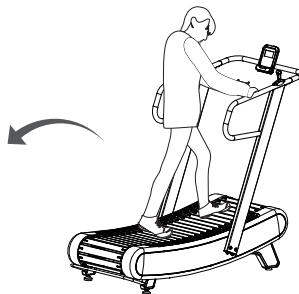

When driving, pull your steering wheel backwards. This will be very dangerous. Please stop.

Please don't put your feet on the roller.

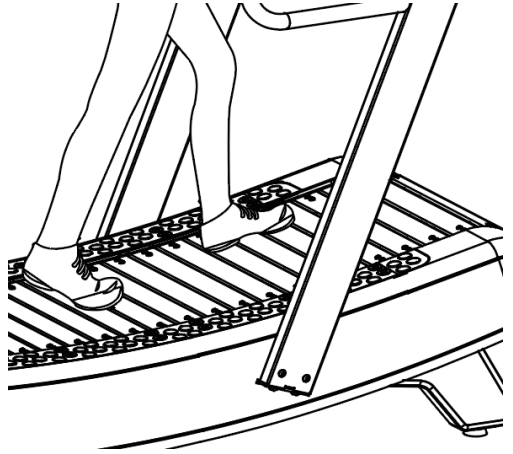
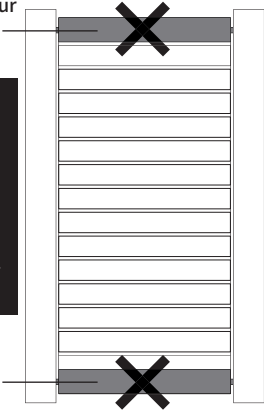

When indoor runners get off, please slow down and get off.

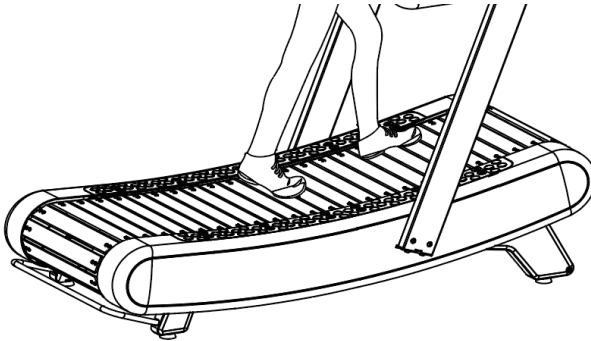

It may cause injury such as pinching your feet. Do not use with bare feet, socks or slippers. Be sure to wear running shoes when using it.

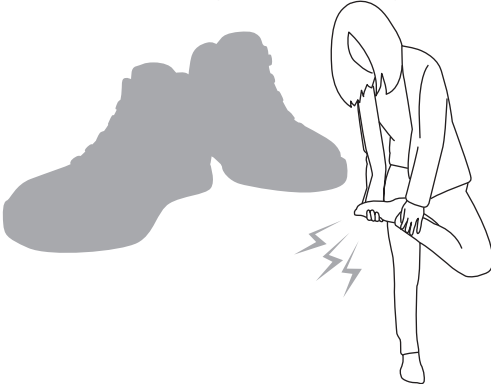

If you feel something wrong with the belt while riding, check and adjust the belt. Adjusting the running belt.





Adjust the running belt

When you use a treadmill, the pressure on the running belt is not balanced due to the different forces used by the two feet during running, which causes the running belt to deviate from the center. This deviation is normal, and you need to bring the walking belt back to the center. Observe which side the walking belt is skewed while running.

If it is biased to the left, use a hex wrench to turn the left screw clockwise or the right screw 1/4 turn counterclockwise,

If it is biased to the right, use a hex wrench to turn the right screw clockwise or the left screw 1/4 turn counterclockwise

If the walking belt is still not in the middle, repeat the above movements until it is adjusted to the middle

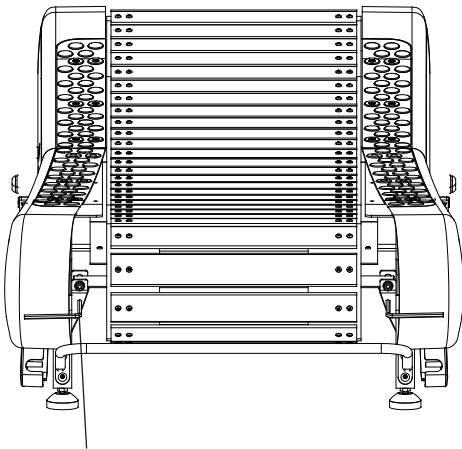

6mm hexagon wrench

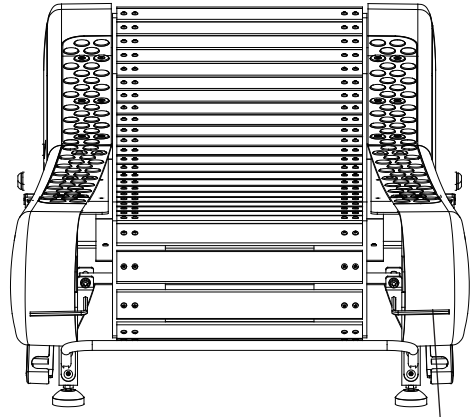

6mm hexagon wrench

After the adjustment, pay attention to whether the lowest point of the running belt touches the ground. If so, adjust the both sides of the walking belt clockwise at the same time until it cannot reach the ground.

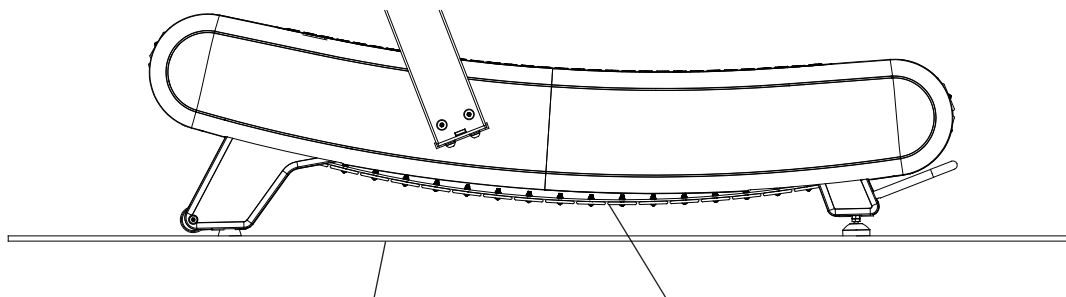

The lowest point of the walking belt must not touch the ground.

Use treadmill:

Place the treadmill on a flat ground (if the ground is uneven, the running belt will deflect)

First stand on the side strips on both sides of the treadmill, then hold your hand on the handrail, then step into the running area and start slowly, gradually increase your footsteps until you want

The speed you want; when you want to stop running, hold your hand on the handrail, then gradually slow down your footsteps to stop.

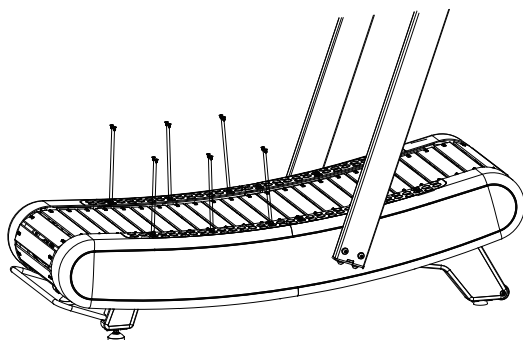
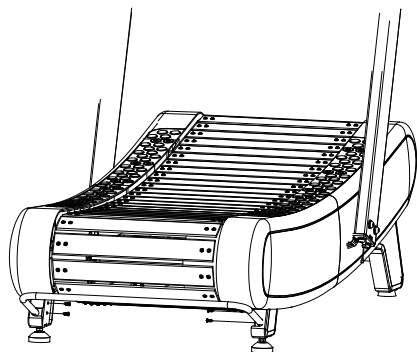

Open the cover, there are adjustment bolts in the front and back four places. Refer to the following to adjust.

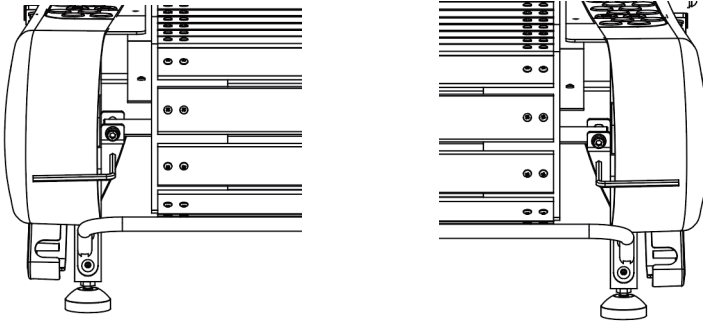

The cover cannot fall off completely. Because it is the cause of injury and malfunction, please do not exert excessive force.

When the belt is biased to one side

If you make a sound other than the normal working sound, then your belt may rub on one side

An adjustment bolt on the side of the belt is included. Use the included hexagonal wrench, turn clockwise little by little

Turn the belt for about 5 minutes, do not improve

In case of abnormal noise, it may be too tight because of it, so please relax a little

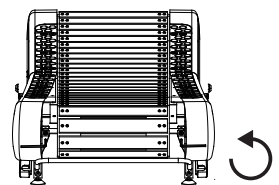
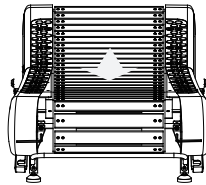
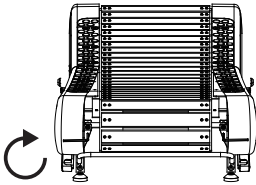

If the stitches are too tight, there is a possibility of shortening the life of the belt

Use a hex wrench with adjustment bolt to turn the counterclockwise about 1/4. Execution equal to left and right

The whole belt is slightly raised from the board and is pulled out from the middle of the belt about 3cm. Please confirm whether it can rebound

If it is too tight after confirmation, repeat from Plastic back after adjustment

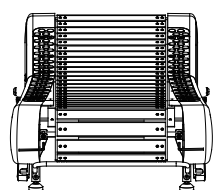
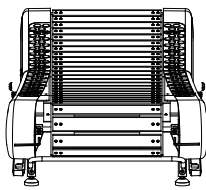
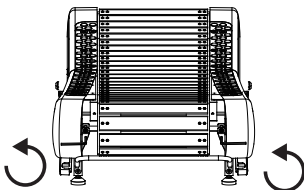

If the deviation of the conveyor belt is fixed, you can install the conveyor belt.



Mobile matters needing attention

Remove the crankcase and fold the steering wheel. Be careful not to pinch your hands and fingers.

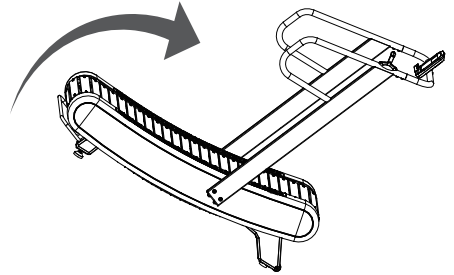

:Hold the steering wheel, lift the steering wheel, please be careful not to let the steering wheel fall.

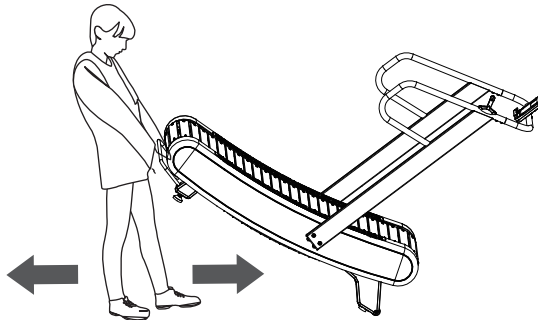
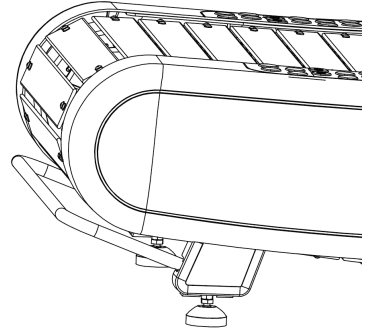



Mobile note

Be careful not to let the steering wheel fall when lifting. Although it can be put down temporarily, please do not stand and leave. In addition, please do not store or keep in a standing state.

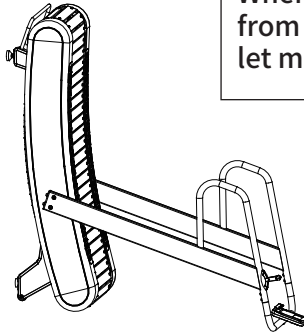

When moving a long distance from room to room, be sure to let more than 2 people move.

Adjusting the tilt angle-You can turn the foot part to adjust the tilt angle. There are two to adjust the balance.

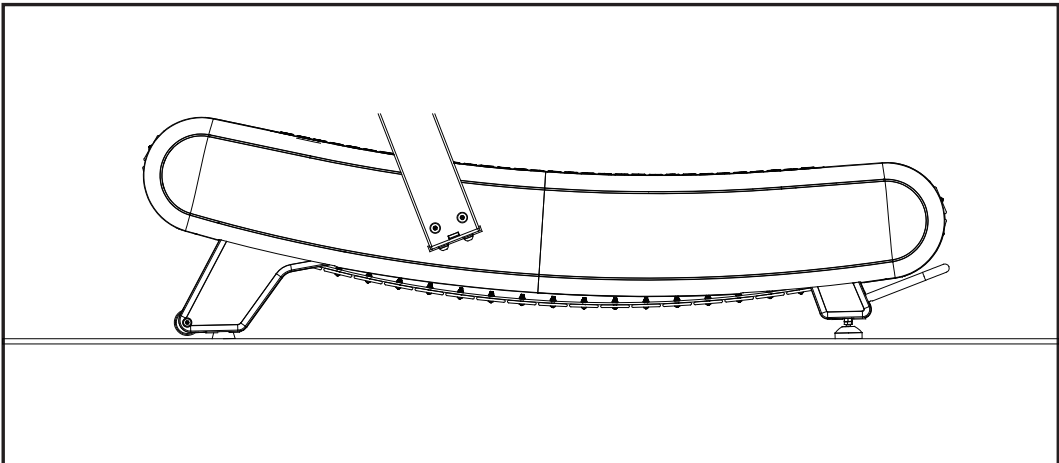



Instrument that



When you start driving or press the button, the display will turn on automatically

It shows what each item says

Mode/Reset button

You can switch the mode/each display item. If you press and hold the reset button, you can reset the previous record of transamination. The cumulative travel distance is not reset. After use, if you do not touch the button for a few minutes, it will automatically shut down.

SPECIFICATIONS:

TIME.....	00:00-99.59
SPEED.....	0:0-99.9 ML/H
DISTANCE.....	0:00-99.99 ML
ODOMETER*(IFHAVE).....	0-9999 ML
PULSE*(IFHAVE).....	40-240BPM
CALORIES.....	0.0-999.9KCAL

KEYFUNCTIONS:

MODE:This key lets you to select and lock on to a particular function you want.

OPERATION PROCEDURES:

1.AUTO ON/OFF

- ◆The system turns on when any key is pressed or when it receives an signal input from the speed sensor
- ◆The system turns offautomatically when the sensor has no signal input or no key are pressed for Approximately 4 minutes.

2. RESET:

The unit can be reset by either changing battery or pressing the mode key for 3 seconds.

3. MODE

To choose SCAN or LOCK if you do not want the scan moed,press the MODE key when the pointer on the function you want which begins blinking.

4. FUNCTIONS:

TIME	Press the MODE key until thepointeradvance toTIME.The total working time will be shown.
SPEED	Press the MODE key until the pointer advance to SPEED.The total working time will be shown.
DISTANCE	Press the MODE key until the pointer advances to DISTANCE.The distance or each workout will be displayed.

- ODOMETER** Press the MODE key until the pointer advances
 *(IF HAVE) to ODOMETER The total accumulated distance
 will be shown
- PULSE** Press the MODE key until the pointer advance
 *(IF HAVE) to PULSE. User's current heart rate will be
 displayed in beats per minute.
 Place the palms of your hands on both of the
 Contact pads (or put ear-clip to ear), and wait
 for 30 seconds for the most accurate reading
- CALORIES** Press the MODE key until the pointer advance
 to CALORIES. The calories burned will be displayed
- SCAN** Automatic display of the following functions in the
 order shown: TIME-SPEED-DISTANCE-
 PULSE (if have)-CALORIES (repeat).
- BATTERY** This monitor uses one or two (if have PULSEE function)
 batteries. If improper display on monitor, please
 reinstall the batteries to have a good result.