

Design for  
**APPLE IPAD**

# COUNTERTOP / WALL / FLOOR SECURITY MOUNT

WITH KEYED LOCK, DRILL DOWN DESIGN & CABLE MANAGEMENT



[www.armor-x.com](http://www.armor-x.com)  
© Copyright all rights reserved



SCM1-IPAD

# 2-IN-1 COUNTERTOP / WALL SECURITY MOUNT

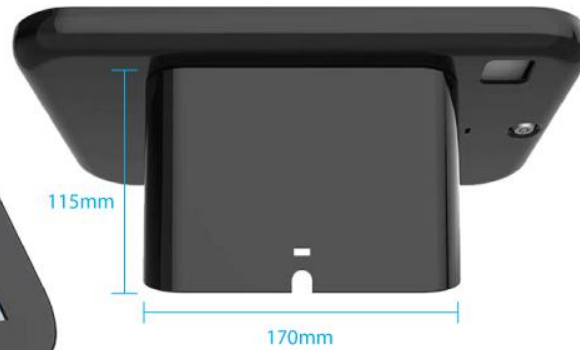

- Designed for audio video conference rooms and telecommunication applications
- Quick lock and unlock keyed lock
- Conceals charging cable
- High-Grade Aluminum Enclosure
- fold, extend and Adjustable Long Arm
- 2-in-1 table stand & wall mount



SECURED DESIGN

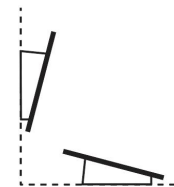

WALL / TABLE TOP

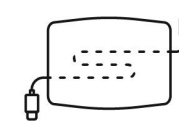

CONCEALS CABLE

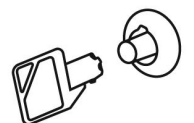

KEY LOCKS

SCM2-IPAD

# COUNTERTOP SECURITY MOUNT

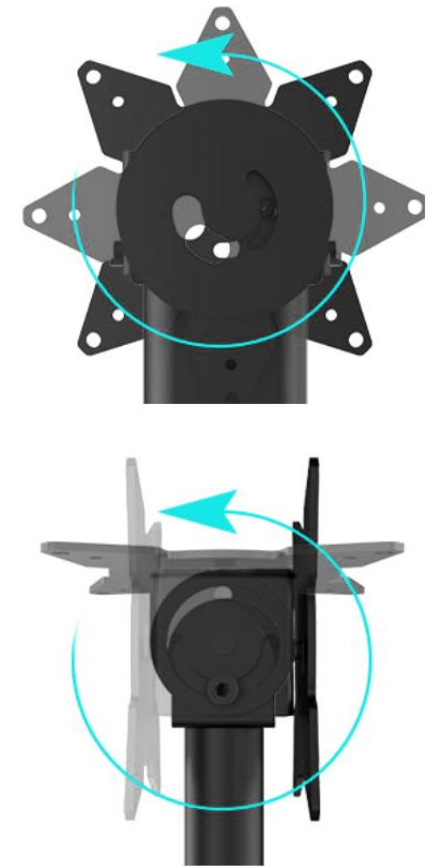

- Quick lock and unlock keyed lock
- Conceals charging cable
- Through arm cable management
- Compatible with our security cable lock



SECURED  
DESIGN

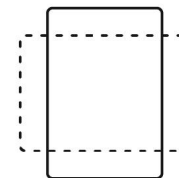

LANDSCAPE / PORTRAIT  
MODE

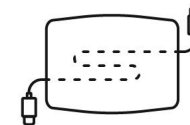

CONCEALS  
CABLE

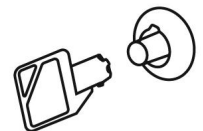

KEY  
LOCKS

SCM3-IPAD

# 2-IN-1 COUNTERTOP / WALL SECURITY MOUNT



- High-grade aluminum enclosure
- Fold, extend and adjustable long arm
- 2-in-1 table stand & wall mount
- Wire and cable management
- Compatible with our security cable lock

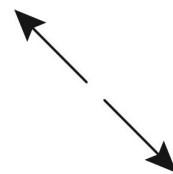

EXTENDS



SECURED  
DESIGN

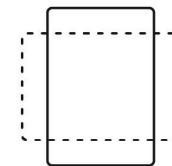

LANDSCAPE /  
PORTRAIT MODE

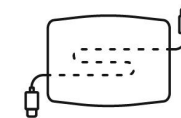

CONCEALS  
CABLE

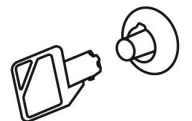

KEY  
LOCKS

# SCM4-IPAD

## WALL SECURITY MOUNT



- Quick lock and unlock keyed lock
- Secured and easy to install
- Suitable for display and hand-held



**SECURED DESIGN**

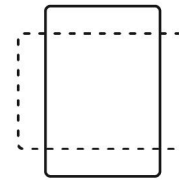

**LANDSCAPE / PORTRAIT MODE**

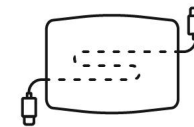

**CONCEALS CABLE**

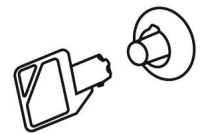

**KEY LOCKS**

SCM5-IPAD

# SECURITY CAR HEADREST MOUNT



- Attaches to a variety of car headrest sizes
- High grade aluminum enclosure
- Conceals charging cable
- Quick lock and unlock keyed lock
- Compatible with our security cable lock



SECURED  
DESIGN

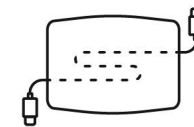

CONCEALS  
CABLE

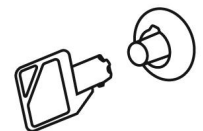

KEY  
LOCKS

# SCM6-IPAD

## SWING SECURITY WALL MOUNT

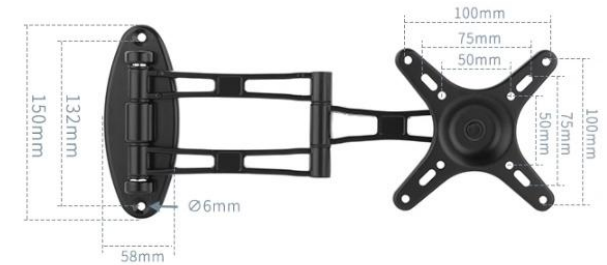

- Tamper-Proof Aluminum Enclosure
- Quick Lock and Unlock Keyed Lock
- Tilt, Pan, and Swing for Multiple Display Angles
- Compatible with our Security Cable Lock



SECURED DESIGN

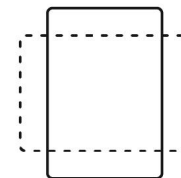

LANDSCAPE / PORTRAIT MODE

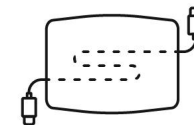

CONCEALS CABLE

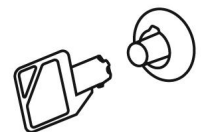

KEY LOCKS

SCM7-IPAD

# EXTENDABLE FLOOR SECURITY MOUNT

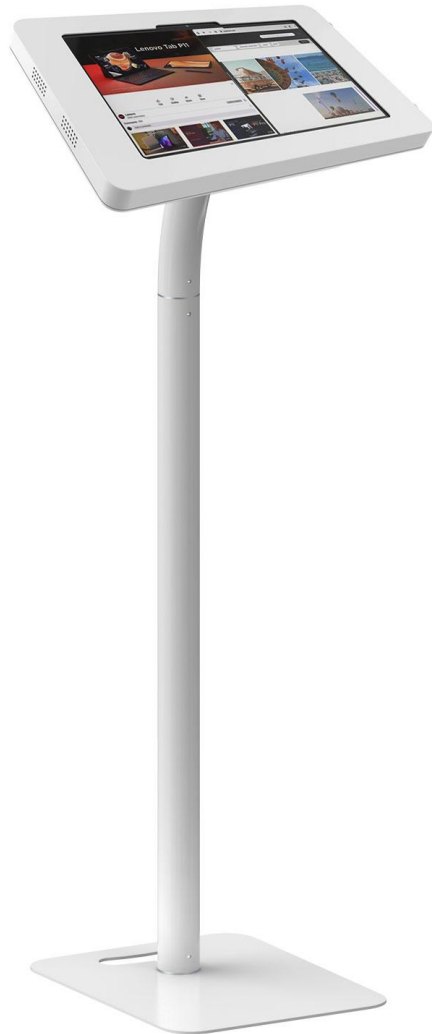

- Quick lock and unlock keyed lock
- Rotate between landscape or portrait mode
- Stand securely to any floor
- Leave freestanding and secure with an optional cable lock

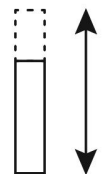

FLOOR /  
TABLETOP



SECURED  
DESIGN

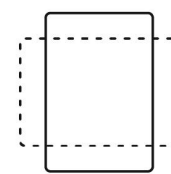

LANDSCAPE /  
PORTRAIT MODE

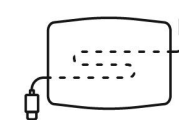

CONCEALS  
CABLE

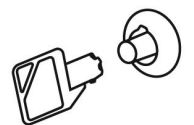

KEY  
LOCKS





steel

ABS

Cover for  
iPad pro 12.9

Cover for screen size  
between 9.7"-11"

aluminium



	<b>MODEL</b>	<b>SKU</b>	<b>ENCLOSURE SIZE</b>	<b>PACKAGE SIZE</b>	<b>NET WEIGHT</b>	<b>GROSS WEIGHT</b>	<b>VOLUMETRIC WEIGHT</b>
	iPad 10.9 (10th Gen.)	SCM1-IPAD-N5	310*208*20 mm	350*250*140mm	1.3kg	1.6kg	2.45kg
	iPad 10.2 (7/8/9th Gen.)	SCM1-IPAD-N4					
	iPad Air 5 / Air 4	SCM1-IPAD-A5					
	iPad Pro 10.5 / iPad Air 3	SCM1-IPAD-A3					
	iPad Pro 11 (1-4 Gen.)	SCM1-IPAD-P11					
	iPad Pro 12.9 (3-6 Gen.)	SCM1-IPAD-P12	370*245*25mm	420*300*140 mm	1.6kg	2kg	3.528kg
	iPad 10.9 (10th Gen.)	SCM2-IPAD-N5	310*208*20 mm	350*250*120 mm	2kg	2.3kg	2.1kg
	iPad 10.2 (7/8/9th Gen.)	SCM2-IPAD-N4					
	iPad Air 5 / Air 4	SCM2-IPAD-A5					
	iPad Pro 10.5 / iPad Air 3	SCM2-IPAD-A3					
	iPad Pro 11 (1-4 Gen.)	SCM2-IPAD-P11					
	iPad Pro 12.9 (3-6 Gen.)	SCM2-IPAD-P12	370*245*25mm	420*300*120mm	2.3kg	2.6kg	3kg
	iPad 10.9 (10th Gen.)	SCM3-IPAD-N5	310*208*20 mm	350*250*130mm	1.9kg	2.2kg	2.275kg
	iPad 10.2 (7/8/9th Gen.)	SCM3-IPAD-N4					
	iPad Air 5 / Air 4	SCM3-IPAD-A5					
	iPad Pro 10.5 / iPad Air 3	SCM3-IPAD-A3					
	iPad Pro 11 (1-4 Gen.)	SCM3-IPAD-P11					
	iPad Pro 12.9 (3-6 Gen.)	SCM3-IPAD-P12	370*245*25mm	420*300*130mm	2.2kg	2.6kg	3kg
	iPad 10.9 (10th Gen.)	SCM4-IPAD-N5	310*208*20 mm	350*250*70mm	0.85kg	1.1kg	1.225kg
	iPad 10.2 (7/8/9th Gen.)	SCM4-IPAD-N4					
	iPad Air 5 / Air 4	SCM4-IPAD-A5					
	iPad Pro 10.5 / iPad Air 3	SCM4-IPAD-A3					
	iPad Pro 11 (1-4 Gen.)	SCM4-IPAD-P11					
	iPad Pro 12.9 (3-6 Gen.)	SCM4-IPAD-P12	370*245*25mm	420*300*70mm	1.15kg	1.4kg	1.764kg



**\*\*COLOR: BLACK / WHITE**

www.armor-x.com  
© Copyright all rights reserved





MODEL	SKU	ENCLOSURE SIZE	PACKAGE SIZE	NET WEIGHT	GROSS WEIGHT	VOLUMETRIC WEIGHT
iPad 10.9 (10th Gen.) iPad 10.2 (7/8/9th Gen.) iPad Air 5 / Air 4 iPad Pro 10.5 / iPad Air 3 iPad Pro 11 (1-4 Gen.)	SCM5-IPAD-N5 SCM5-IPAD-N4 SCM5-IPAD-A5 SCM5-IPAD-A3 SCM5-IPAD-P11	310*208*20 mm	350*250*70 mm	0.9kg	1.2kg	1.225kg
iPad Pro 12.9 (3-6 Gen.)	SCM5-IPAD-P12	370*245*25 mm	420*300*70mm	1.2kg	1.5kg	1.764
iPad 10.9 (10th Gen.) iPad 10.2 (7/8/9th Gen.) iPad Air 5 / Air 4 iPad Pro 10.5 / iPad Air 3 iPad Pro 11 (1-4 Gen.)	SCM6-IPAD-N5 SCM6-IPAD-N4 SCM6-IPAD-A5 SCM6-IPAD-A3 SCM6-IPAD-P11	310*208*20 mm	350*250*130mm	1.2kg	1.5kg	2.275kg
iPad Pro 12.9 (3-6 Gen.)	SCM6-IPAD-P12	370*245*25mm	420*300*130mm	1.5kg	1.8kg	3kg
iPad 10.9 (10th Gen.) iPad 10.2 (7/8/9th Gen.) iPad Air 5 / Air 4 iPad Pro 10.5 / iPad Air 3 iPad Pro 11 (1-4 Gen.)	SCM7-IPAD-N5 SCM7-IPAD-N4 SCM7-IPAD-A5 SCM7-IPAD-A3 SCM7-IPAD-P11	310*208*20 mm	890*420*110mm	7.7kg	9.7kg	8.22kg
iPad Pro 12.9 (3-6 Gen.)	SCM3-IPAD-P12	370*245*25 mm	890*420*110mm	8kg	10kg	8.22kg

\*\*COLOR: BLACK / WHITE



# OPTIONAL SAFETY KEY LOCK CABLE



**LCK01**  
Security Key Lock



**LCK02**  
Combination Security Lock

