

Design for
LENOVO TAB

COUNTERTOP / WALL / FLOOR SECURITY MOUNT

WITH KEYED LOCK, DRILL DOWN DESIGN & CABLE MANAGEMENT



www.armor-x.com
© Copyright all rights reserved



SCM1-LN

2-IN-1 COUNTERTOP / WALL SECURITY MOUNT



- Designed for audio video conference rooms and telecommunication applications
- Quick lock and unlock keyed lock
- Conceals charging cable
- High-Grade Aluminum Enclosure
- fold, extend and Adjustable Long Arm
- 2-in-1 table stand & wall mount



**SECURED
DESIGN**

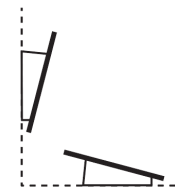

**WALL /
TABLE TOP**

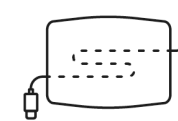

**CONCEALS
CABLE**

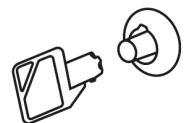

**KEY
LOCKS**

SCM2-LN

COUNTERTOP SECURITY MOUNT

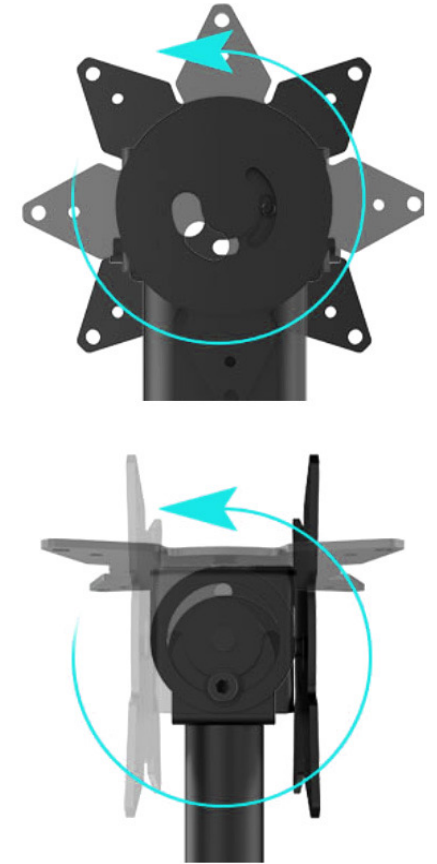

- Quick lock and unlock keyed lock
- Conceals charging cable
- Through arm cable management
- Compatible with our security cable lock



**SECURED
DESIGN**

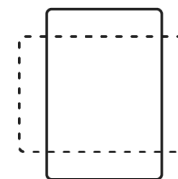

**LANDSCAPE / PORTRAIT
MODE**

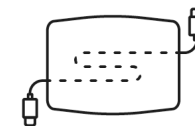

**CONCEALS
CABLE**

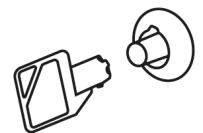

**KEY
LOCKS**

SCM3-LN

2-IN-1 COUNTERTOP / WALL SECURITY MOUNT



- High-grade aluminum enclosure
- Fold, extend and adjustable long arm
- 2-in-1 table stand & wall mount
- Wire and cable management
- Compatible with our security cable lock

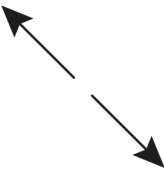

EXTENDS



SECURED DESIGN

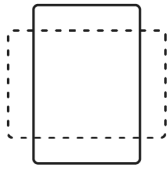

LANDSCAPE / PORTRAIT MODE

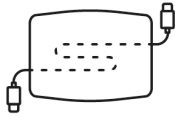

CONCEALS CABLE

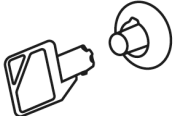

KEY LOCKS

SCM4-LN

WALL SECURITY MOUNT

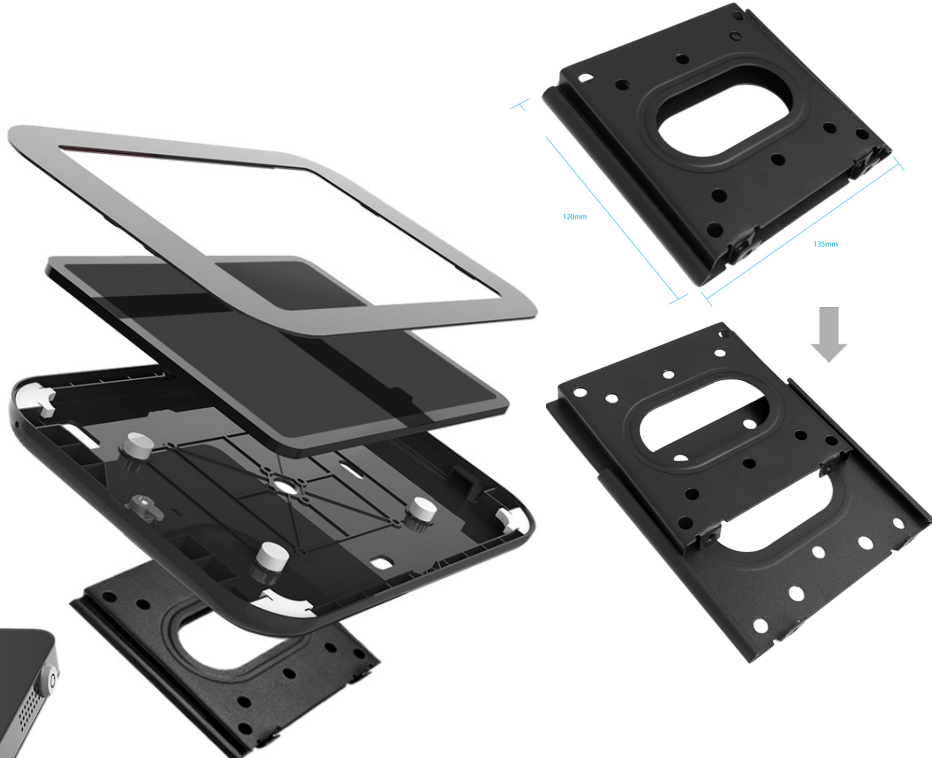

- Quick lock and unlock keyed lock
- Secured and easy to install
- Suitable for display and hand-held



SECURED DESIGN

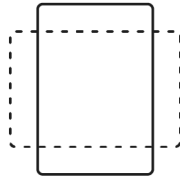

LANDSCAPE / PORTRAIT MODE

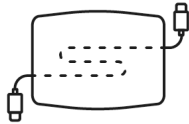

CONCEALS CABLE

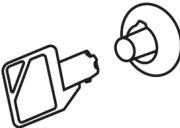

KEY LOCKS

SCM5-LN

SECURITY CAR HEADREST MOUNT



- Attaches to a variety of car headrest sizes
- High grade aluminum enclosure
- Conceals charging cable
- Quick lock and unlock keyed lock
- Compatible with our security cable lock



**SECURED
DESIGN**

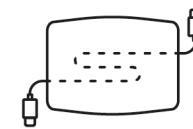

**CONCEALS
CABLE**

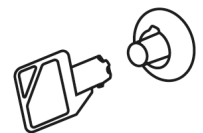

**KEY
LOCKS**

SCM6-LN

SWING SECURITY WALL MOUNT

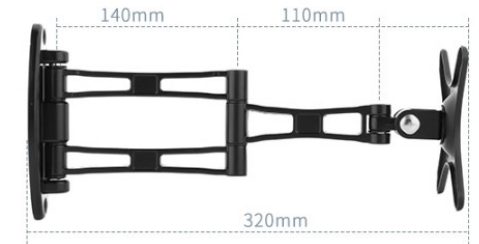
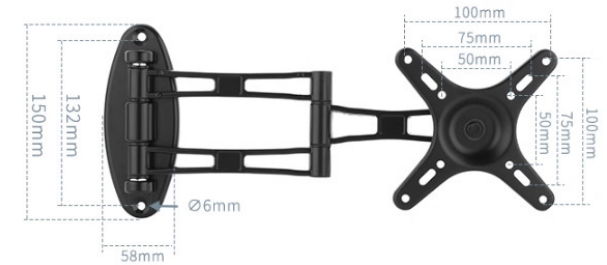
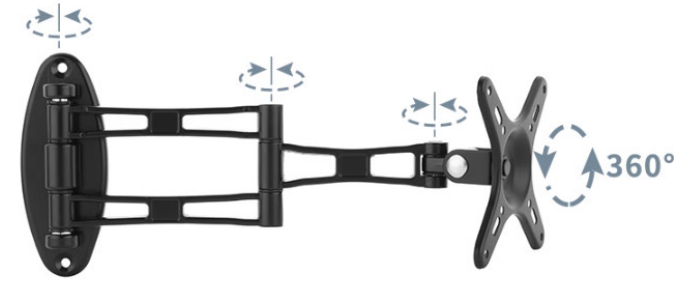

- Tamper-Proof Aluminum Enclosure
- Quick Lock and Unlock Keyed Lock
- Tilt, Pan, and Swing for Multiple Display Angles
- Compatible with our Security Cable Lock



SECURED DESIGN

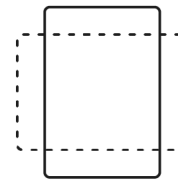

LANDSCAPE / PORTRAIT MODE

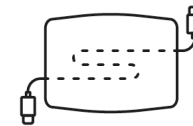

CONCEALS CABLE

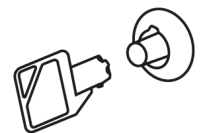

KEY LOCKS

SCM7-LN

EXTENDABLE FLOOR SECURITY MOUNT

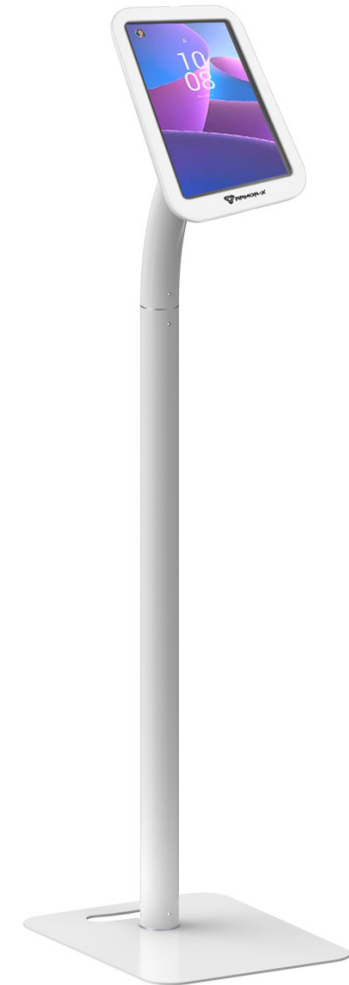
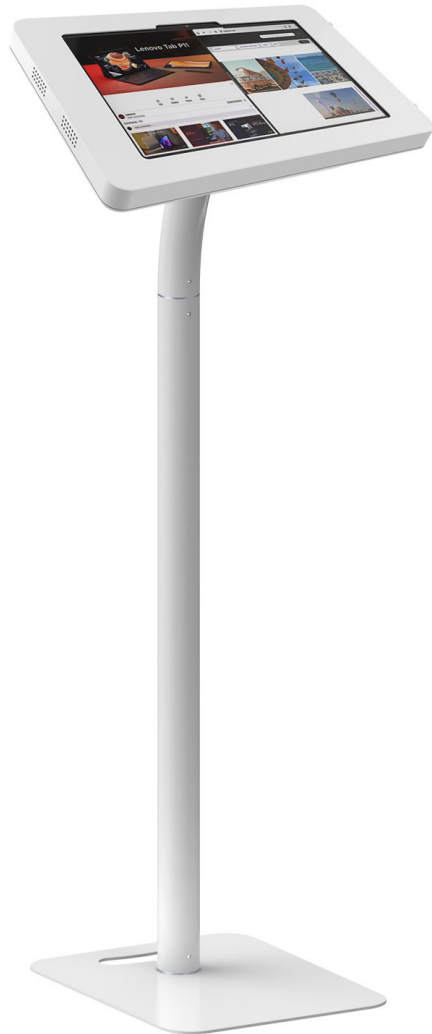

- Quick lock and unlock keyed lock
- Rotate between landscape or portrait mode
- Stand securely to any floor
- Leave freestanding and secure with an optional cable lock



FLOOR /
TABLETOP



SECURED
DESIGN

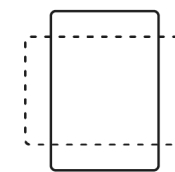

LANDSCAPE /
PORTRAIT MODE

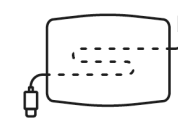

CONCEALS
CABLE

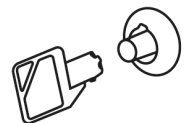

KEY
LOCKS

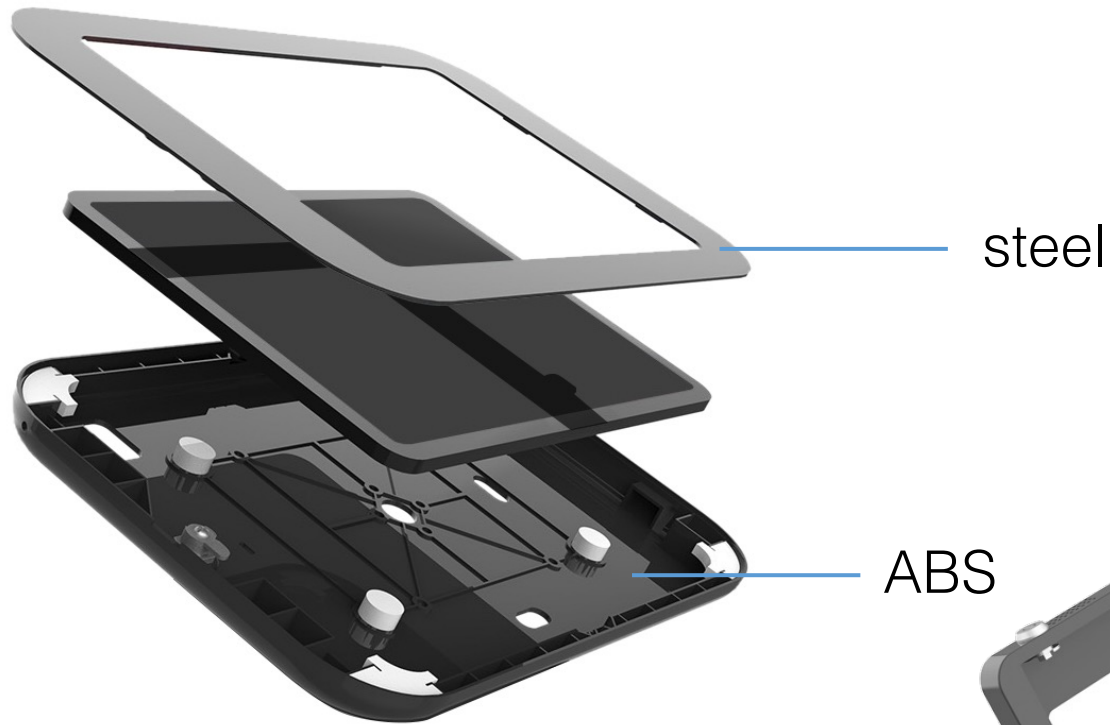

Cover for P11 (Gen2)
Tab P11 PRO (Gen 2 /
1)

Cover for screen size
between 9.7"-11"





MODEL	SKU	ENCLOSURE SIZE	PACKAGE SIZE	NET WEIGHT	GROSS WEIGHT	VOLUMETRIC WEIGHT
Tab K10 / M10 Plus Tab M10 (Gen3) Tab M10 Plus (Gen3) Tab M10 5G Tab M9	SCM1-LN-K10 SCM1-LN-M10V3 SCM1-LN-M10P3 SCM1-LN-M105G SCM1-LN-M9	310*208*20 mm	350*250*140mm	1.3kg	1.6 kg	2.45 kg
Tab P11 (Gen2) Tab P11 PRO (Gen 2 / 1)	SCM1-LN-P11G2 SCM1-LN-P11PR2	335*208*22mm	380*260*140 mm	1.4 kg	2.0 kg	2.77 kg
Tab K10 / M10 Plus Tab M10 (Gen3) Tab M10 Plus (Gen3) Tab M10 5G Tab M9	SCM2-LN-K10 SCM2-LN-M10V3 SCM2-LN-M10P3 SCM2-LN-M105G SCM2-LN-M9	310*208*20 mm	350*250*120 mm	2.0 kg	2.3 kg	2.1 kg
Tab P11 (Gen2) Tab P11 PRO (Gen 2 / 1)	SCM3-LN-P11G2 SCM3-LN-P11PR2	335*208*22mm	380*260*120 mm	2.1 kg	2.6kg	2.37 kg
Tab K10 / M10 Plus Tab M10 (Gen3) Tab M10 Plus (Gen3) Tab M10 5G Tab M9	SCM3-LN-K10 SCM3-LN-M10V3 SCM3-LN-M10P3 SCM3-LN-M105G SCM3-LN-M9	310*208*20 mm	350*250*130mm	1.9 kg	2.2kg	2.28 kg
Tab P11 (Gen2) Tab P11 PRO (Gen 2 / 1)	SCM3-LN-P11G2 SCM3-LN-P11PR2	335*208*22mm	380*260*130mm	2.0 kg	2.6kg	2.57 kg
Tab K10 / M10 Plus Tab M10 (Gen3) Tab M10 Plus (Gen3) Tab M10 5G Tab M9	SCM4-LN-K10 SCM4-LN-M10V3 SCM4-LN-M10P3 SCM4-LN-M105G SCM4-LN-M9	310*208*20 mm	350*250*70mm	0.85 kg	1.1 kg	1.23 kg
Tab P11 (Gen2) Tab P11 PRO (Gen 2 / 1)	SCM4-LN-P11G2 SCM4-LN-P11PR2	335*208*22mm	380*260*70mm	0.95 kg	1.4 kg	1.38 kg



**COLOR: BLACK / WHITE

www.armor-x.com
© Copyright all rights reserved





MODEL	SKU	ENCLOSURE SIZE	PACKAGE SIZE	NET WEIGHT	GROSS WEIGHT	VOLUMETRIC WEIGHT
Tab K10 / M10 Plus Tab M10 (Gen3) Tab M10 Plus (Gen3) Tab M10 5G Tab M9	SCM5-LN-K10 SCM5-LN-M10V3 SCM5-LN-M10P3 SCM5-LN-M105G SCM5-LN-M9	310*208*20 mm	350*250*70 mm	0.9 kg	1.2 kg	1.23 kg
Tab P11 (Gen2) Tab P11 PRO (Gen 2 / 1)	SCM5-LN-P11G2 SCM5-LN-P11PR2	335*208*22mm	380*260*70mm	1.0 kg	1.5 kg	1.38 kg
Tab K10 / M10 Plus Tab M10 (Gen3) Tab M10 Plus (Gen3) Tab M10 5G Tab M9	SCM6-LN-K10 SCM6-LN-M10V3 SCM6-LN-M10P3 SCM6-LN-M105G SCM6-LN-M9	310*208*20 mm	350*250*130mm	1.2 kg	1.5 kg	2.28 kg
Tab P11 (Gen2) Tab P11 PRO (Gen 2 / 1)	SCM6-LN-P11G2 SCM6-LN-P11PR2	335*208*22mm	380*260*130mm	1.3 kg	1.8 kg	2.57 kg
Tab K10 / M10 Plus Tab M10 (Gen3) Tab M10 Plus (Gen3) Tab M10 5G Tab M9	SCM7-LN-K10 SCM7-LN-M10V3 SCM7-LN-M10P3 SCM7-LN-M105G SCM7-LN-M9	310*208*20 mm	890*420*110mm	7.7kg	9.7kg	8.22kg
Tab P11 (Gen2) Tab P11 PRO (Gen 2 / 1)	SCM7-LN-P11G2 SCM7-LN-P11PR2	335*208*22mm	890*420*110mm	8kg	10kg	8.22kg

**COLOR: BLACK / WHITE



OPTIONAL SAFETY KEY LOCK CABLE



LCK01
Security Key Lock



LCK02
Combination Security Lock

