



AquaFire®

Installation Guidelines
and Best Practices

AquaFire Pro Series

AWPR2-20 / AWPR2-40 / AWPR2-60

Experience the world's most advanced water vapor fireplace technology in our most advanced model yet, the Aquafire Pro.



Aquafire Pro Series

3 Sizes, AWPR2-20-50 20" / AWPR2-40-100 40" / AWPR2-60-150 60" .



Shown: AWPR2-40-100 40"

- Units can be ganged together to create continuous ribbons of flames up to 20 feet (240").
- Can be direct plumbed for automated filling (unlimited run time), or manually (20 hours of run time).
- Integrated pumping system can remove water from the tank(s) or be used to fill manually without overflowing.
- Adjust flame color, size and speed (intensity) (8" to 10" flames).
- Set flames to natural color or select from 30 other preset colors.
- Control via button on device, smart phone app, or integrate with in-room automation via the dry port contact.
- Easy Flush Mount Install.
- Air Intake through the lid.
- Alternate Hidden Air Intake (from below).
- Internal UV-C Lighting sanitizes water & vapor.

Quick Start Guide

1. Installing Into Its Site-Built Enclosure

- 1 Remove the top plate.
- 2 Connect the 24V power adapter (located on the back side of the unit).
- 3 Install Aquafire into its housing, as shown in example below.
- 4 Reinstall the top plate of the fireplace and install is complete.

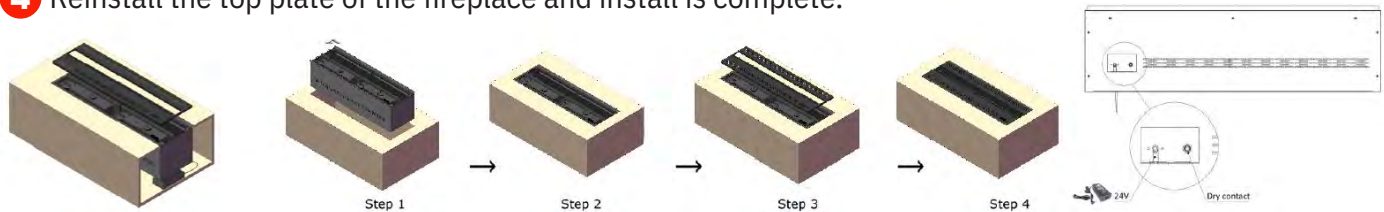

2. Filling Aquafire with Automatic Pump

- 1 When the water tank is empty, you will see the lights blinking and you will hear small beeps.
- 2 Connect the fill tube to the water connector and press and hold the "B1" button for 5 seconds.
- 3 The filling will start automatically and will end automatically when the water tank is full.

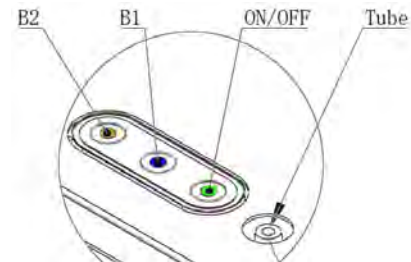

3. Connecting to Water Supply

- 1 Connect a suitable reducer to the water network. (Reducer = water network tube dimensions to 1/4")
- 2 Connect the 1/4" PEX pipe to Aquafire. Two possible connections: Bottom opening or side opening.

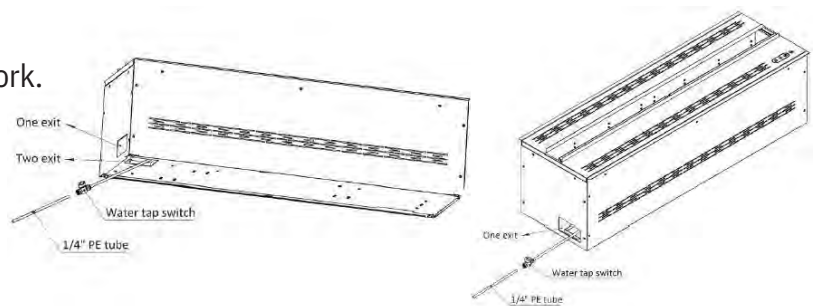

4. Pairing the Remote Control

- 1 Press and hold the Power button on the unit for 5 seconds or until the button will begins flashing.
- 2 Press any button on the remote, you will hear a beep.
- 3 Beep confirms the control is paired to the unit.

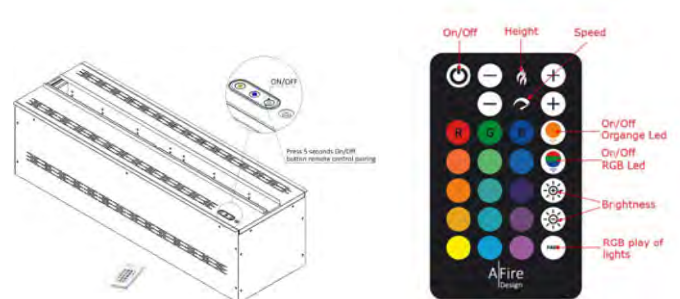



Preliminary Planning Information

Aquafire Pro water vapor fireplace inserts have been designed to be extremely easy to install, simple to operate, and easy to maintain. When designing your fireplace, feel free to send your plans in for review and suggestions by our professional design staff.

Considerations:

- Accessibility to electricity and 1/4" water line, similar to ice maker in fridge.
- Recessed into wall, sitting proud of a wall or completely free-standing?
- If light cast upwards to ceiling is undesirable, consider recessing into the wall for a traditional hearth appearance. (we advise to create a 'light trap'. see **Light Trap** page for details)
- Determine decorative materials and finishes you expect to use. Since there is no heat, there are virtually no limitations.
- Plan to make it easy to remove fireplace insert should maintenance or repairs become necessary.
- Avoid or prevent air currents from doors, windows, and existing HVAC system which affect flame quality.

Installation:

Prepare the housing for your fireplace insert(s) and make sure the cutout has sharp corners (not rounded) and dimensions are exactly as specified. These dimensions are critical because the modules are suspended on flanges that span the opening. Too small, and fireplace will not fit, too large of opening, and fireplace insert will look sloppy or may even fall through the opening. Using the built in 'lifting loops', suspend the **Aquafire Pro** into the cutout after plugging in electric power converter(s) and connecting the 1/4" waterline if direct plumbed. If not direct plumbed, fill tank using tap water via the integrated pumping system once installed into cutout.

That's it!– the installation is complete. Now start your fireplace and enjoy an extraordinary fireplace experience every day of the year!



World's most advanced
water vapor fireplace
technology!

Fireplace Specs and Cutout Dimensions

Aquafire Dimensions

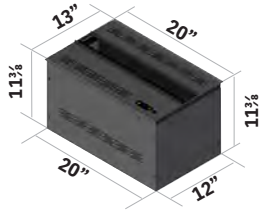

20" AWPR2-20-50:

Power: 60 W (Standard wall receptacle)
Tank Capacity: 2.0 Liters / Run Time 20 Hours
Direct Plumbed: 1/4" water line
Weight: 29 lbs / Crated Weight 53 lbs

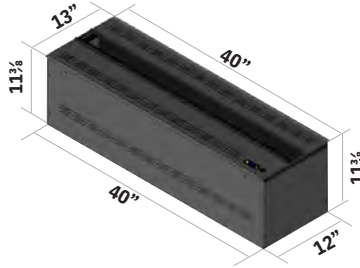

40" AWPR2-40-100:

Power: 120 W (Standard wall receptacle)
Tank Capacity: 4.0 Liters / Run Time 20 Hours
Direct Plumbed: 1/4" water line
Weight: 58 lbs / Crated Weight 90 lbs

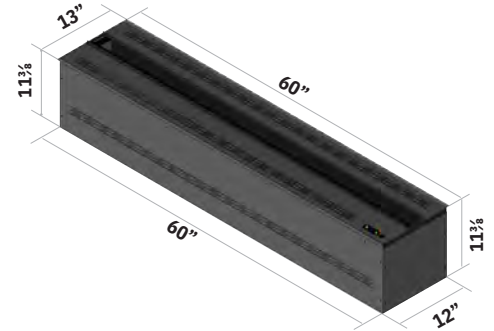

60" AWPR2-60-150:

Power: 180 W (Standard wall receptacle)
Tank Capacity: 6.5 Liters / Run Time 20 Hours
Direct Plumbed: 1/4" water line
Weight: 89 lbs / Crated Weight 123 lbs

Cutout Dimensions

SIZE	W	D	H
20" AWPR2-20-50:	20 1/4" x	12 1/8" x	13 5/8" "
40" AWPR2-40-100:	40 1/4" x	12 1/8" x	13 5/8" "
60" AWPR2-60-150:	60 1/4" x	12 1/8" x	13 5/8" "

Note:

Cutout dimensions are critical! Fireplace inserts are suspended in cutout opening from the attached flanges so be sure to measure carefully!

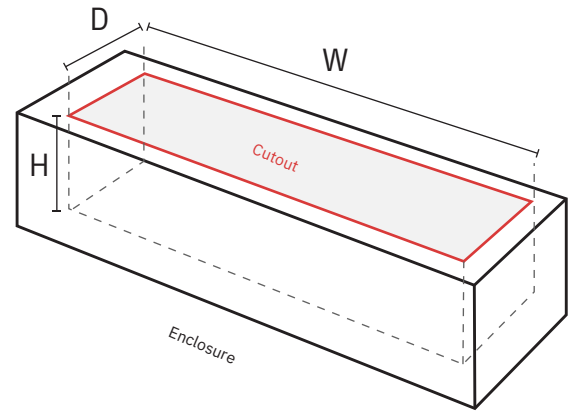

Up to 20 Feet of Flame

Connect and combine fireplace inserts together to create up to 20 feet of continuous flame that can be controlled by a single remote.



Up to 20 Feet (240 Inches)

Enclosure Design Guidelines

Light Trap Best Practices

Design Review!

When you have your design schematic or working drawings, it's a good idea to get a review by an Aquafire professional. We are here to help! sales@aquafire.com

SIDE VIEW
SINGLE-SIDED HEARTH

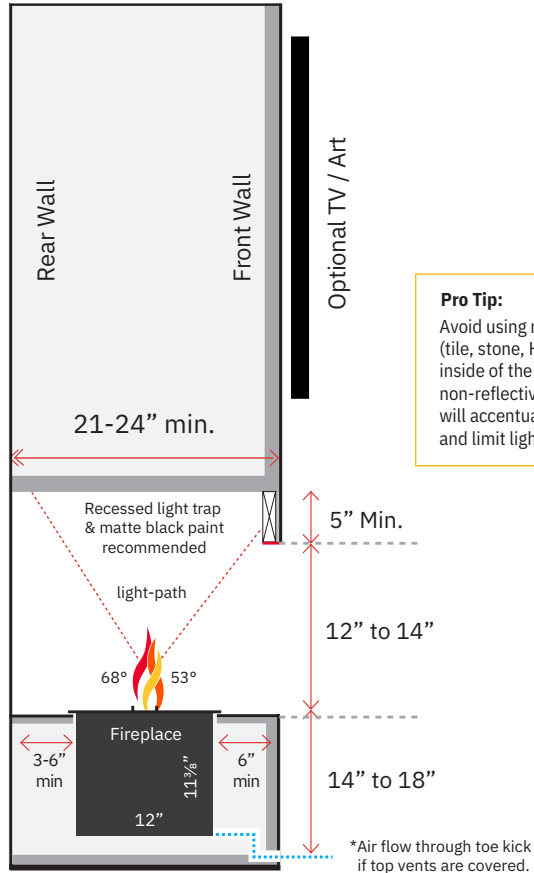

SIDE VIEW
DOUBLE-SIDED HEARTH

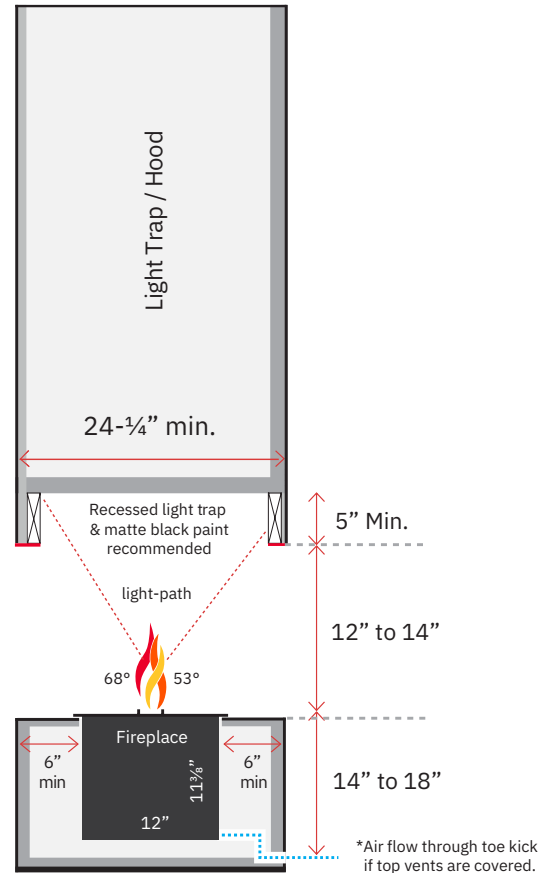

PLAN VIEW
SINGLE SIDED & DOUBLE-SIDED HEARTH (walls optional)

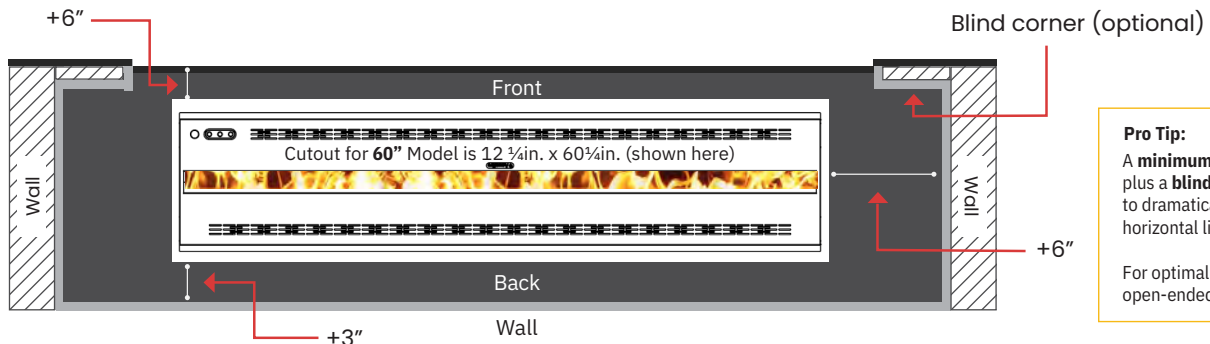

Installing Aquafire Insert

Installing Insert into custom enclosure

SIDE VIEW

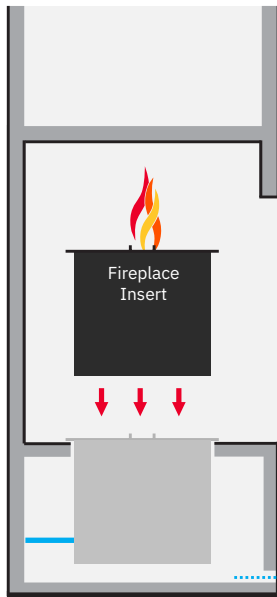

FRONT VIEW

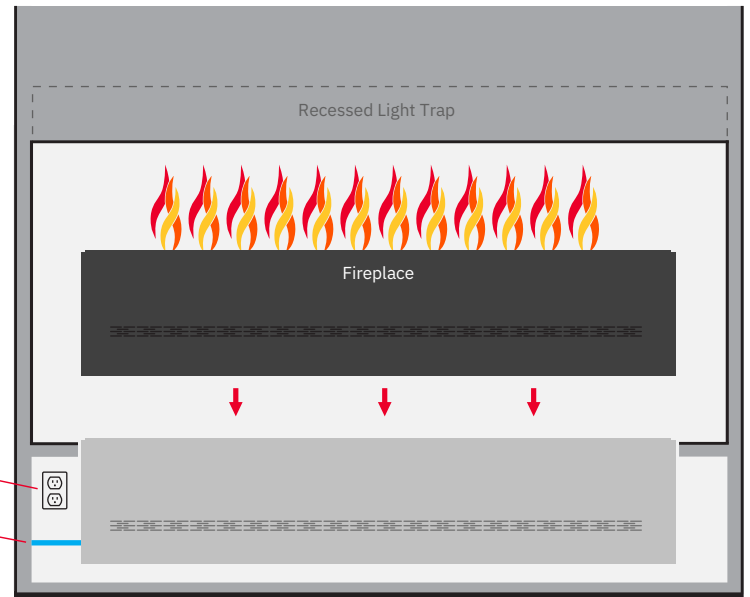

120v/60 Hz (min 12-amp) outlet

Optional 1/4 PE water supply line

Air Intake through toe kick,
Optional if top vents are covered

Drop-in install

Aquafire inserts are designed to drop in to an enclosure and hang from the lid's flanges, allowing for easy install and adequate airflow underneath the unit.

Cutout Dimensions

SIZE		W	D	H
20"	AWPR2-20-50:	20 1/4"	12 1/8"	13 5/8"
40"	AWPR2-40-100:	40 1/4"	12 1/8"	13 5/8"
60"	AWPR2-60-150:	60 1/4"	12 1/8"	13 5/8"

Note:

Cutout dimensions are critical! Fireplace inserts are suspended in cutout opening from the attached flanges so be sure to measure carefully!

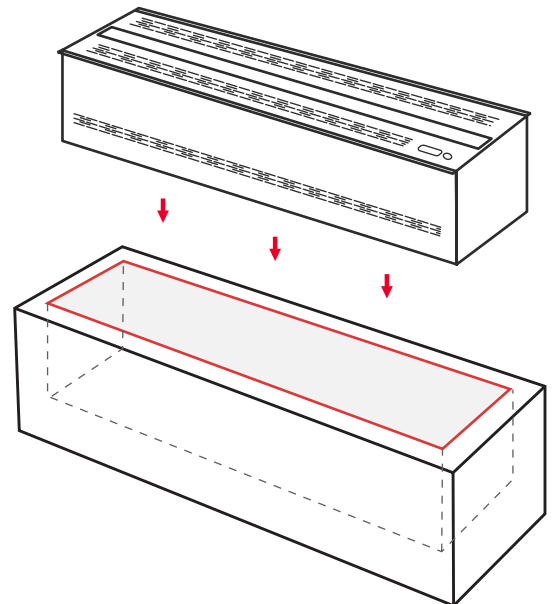

Enclosure Design Guidelines

Enclosure Ideas

Some examples of the many ways to install Aquafire.

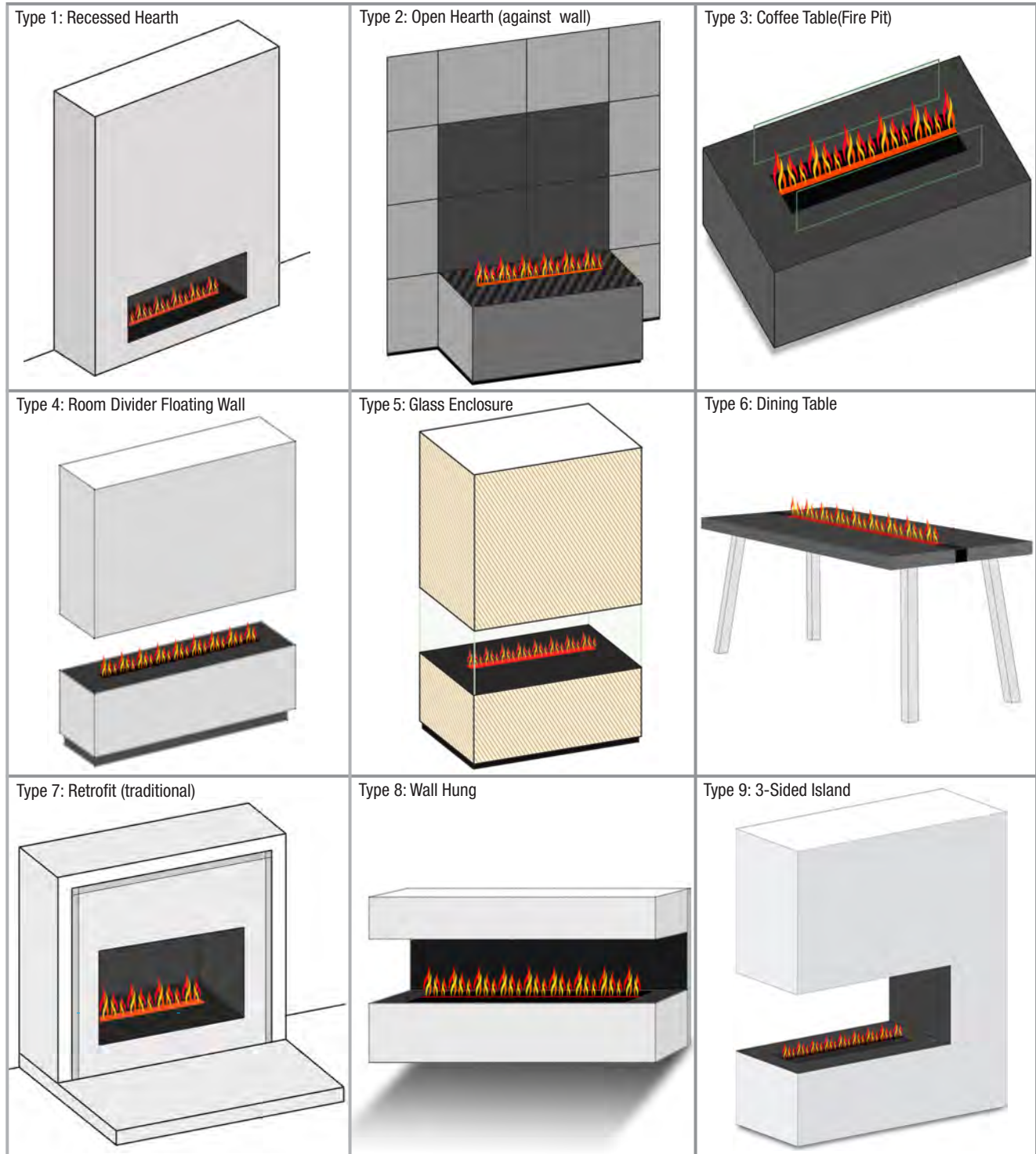

Enclosure Design Guidelines

Light Trap Best Practices (cont'd)

SIDE VIEW
SINGLE-SIDED HEARTH

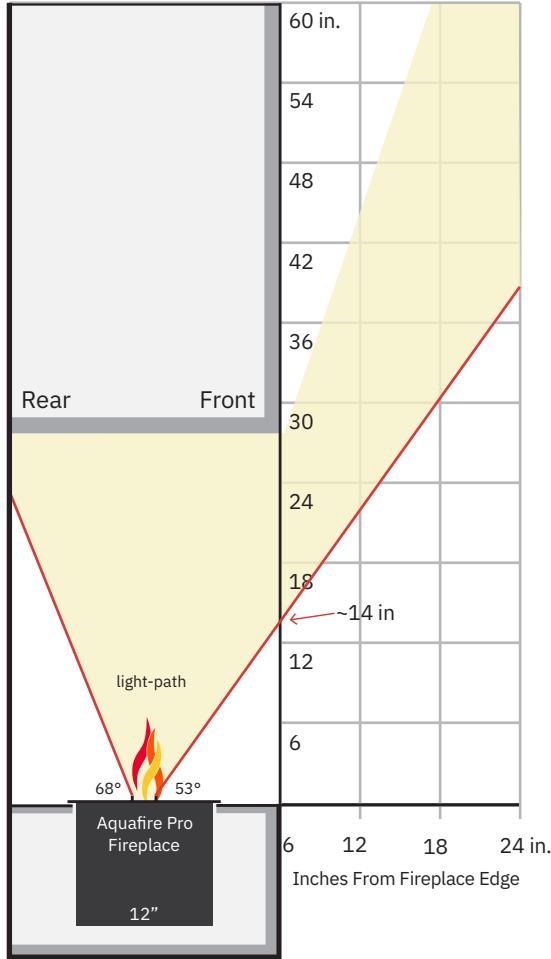

SIDE VIEW
DOUBLE-SIDED HEARTH

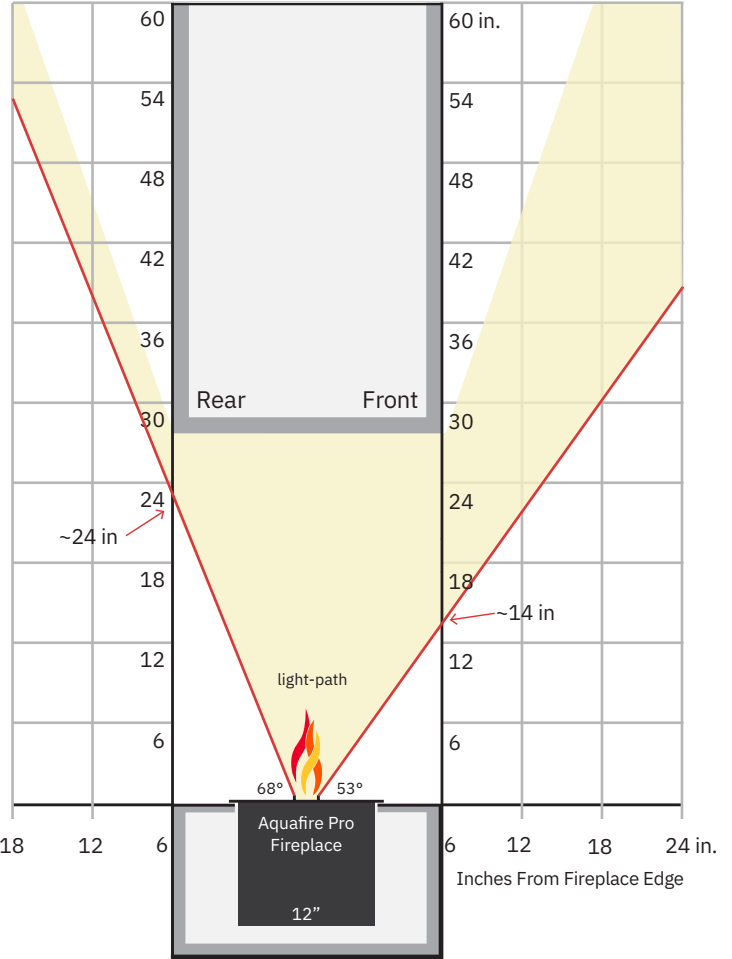

Be aware of side light reflection!

A **minimum of 12"** clearance plus a **blind corner** will help to dramatically cut down on horizontal light reflection. For optimal results, utilize an open-ended design.

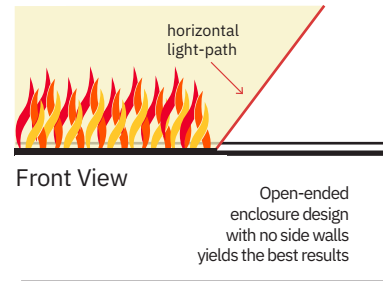
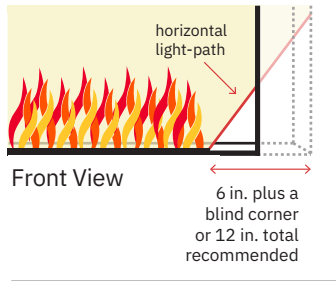

Enclosure Design Guidelines

Air Flow Best Practices

SIDE VIEW SINGLE-SIDED HEARTH

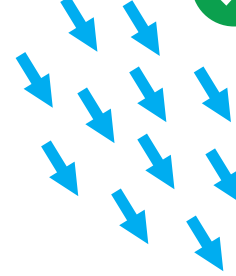
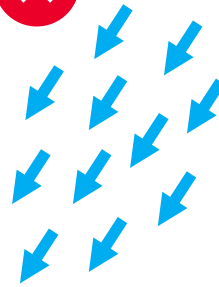

Air currents

Avoid blowing air currents from HVAC units directly toward the Aquafire insert. Direct air currents can prevent vapor from rising vertically as designed and limit the flame height.

Air intake requirements

Aquafire inserts require at least 50 square inches of air intake within the enclosure for every 20 inches of unit length. This is achieved by venting through either the top lid or, if covered, via a toe kick beneath the enclosure.

Air vents

Air vents are situated atop the insert to enable airflow when the device is placed within an enclosure. Should there be a preference for a decorative top or media obstructing these vents, the enclosure design needs to facilitate adequate airflow through the sides or bottom.

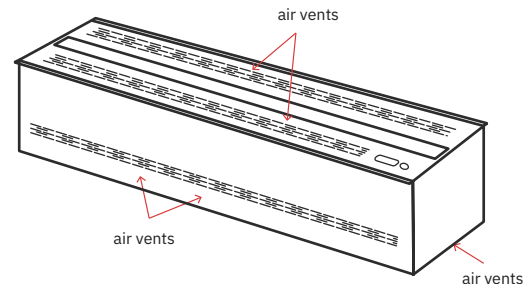

Maintenance and Cleaning Guidelines

Hard Water Guidelines

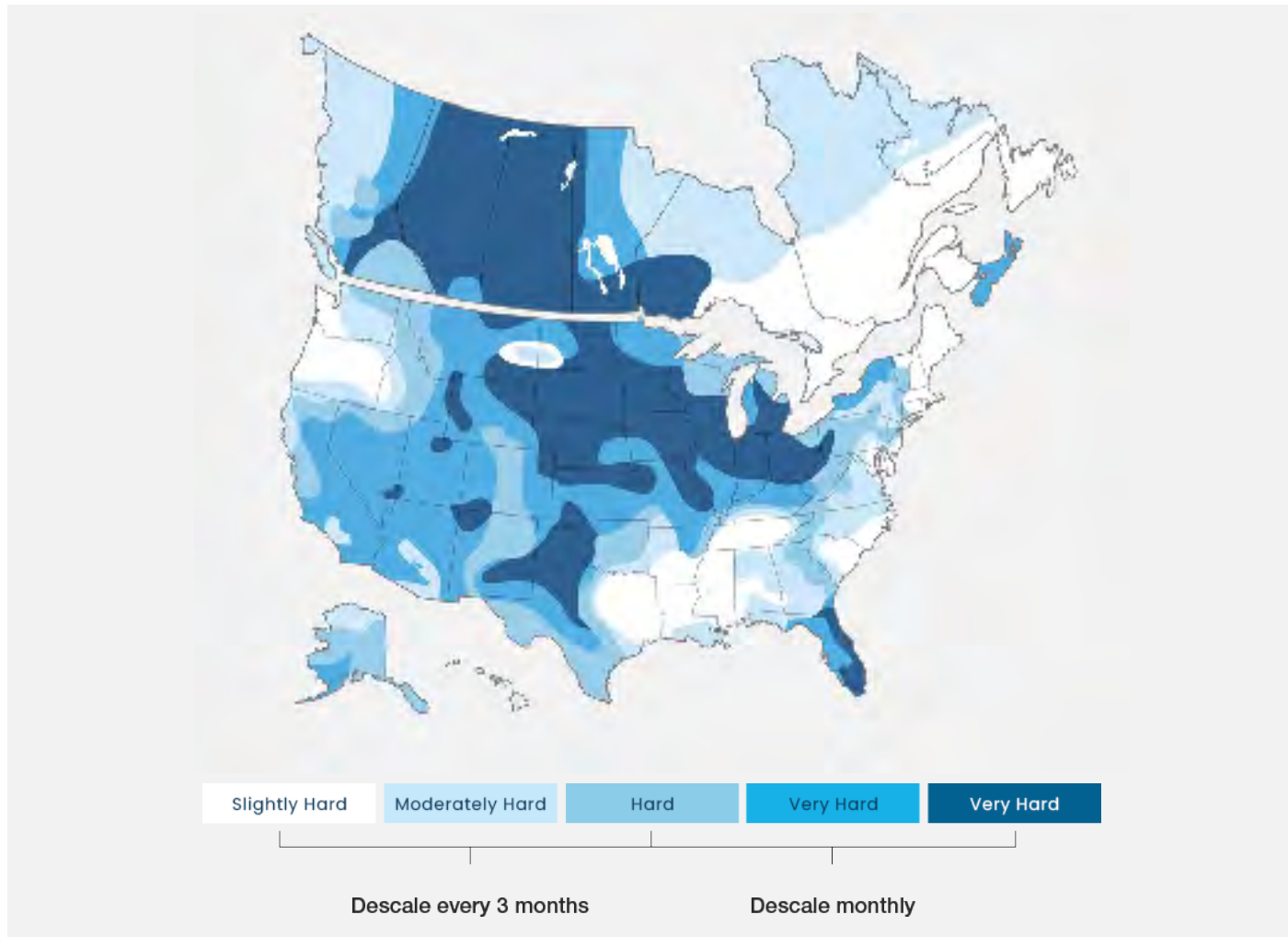

For best results, descale your fireplace every three months or more frequently if you live in an area with hard water.

3.5 to 8.5 Grains Per Gallon, Ideal is 7.0 (moderately hard)

- Hard may produce scaling, shorten transducer life, and require more frequent cleaning.
- If water hardness needs to be adjusted, consult local water conditioning professional.
- Water that is too soft will have reduced flame effect.

Reverse Osmosis is not recommended, it removes all minerals and vapor flame effect will be greatly diminished.

For complete descaling instruction visit

<https://waterfireplaces.com/pages/aquafire-preventative-maintenance-guidelines>



Contact Us

www.waterfireplaces.com

www.waterfireplaces.com