



## **Rooftop DC Air Conditioner**



**Model: 2000R**

**Instruction Manual**

Thank you for purchasing this VELIT 2000R Rooftop Air Conditioner. For safety and the best performance, please read and follow these instructions carefully. The latest electronic version of this document is available for download at the product page. We wish you enjoy your Velit air conditioner. For any product questions or issues, you can reach out to us at [support@velitcamping.com](mailto:support@velitcamping.com) or use the online chat box at [velitcamping.com](http://velitcamping.com).

## Table of Contents

<b>1. IMPORTANT SAFETY INSTRUCTION</b>	<b>3</b>
<b>2. SPECIFICATIONS</b>	<b>4</b>
<b>3. INSTALLATION</b>	<b>5</b>
<b>4. OPERATION</b>	<b>8</b>
<b>5. TROUBLESHOOTING</b>	<b>11</b>



# 1. IMPORTANT SAFETY INFORMATION

This manual has safety information to help users eliminate or mitigate the risk of accidents and injuries.

The installation of this unit MUST comply with the following code:

U.S: NFPA1192, NFPA70

CANADA: C22.1, CSA Z240

## 1.1 Understand Signal Words

### **⚠ WARNING**

Indicates a hazardous situation that if NOT avoided, could result in death or serious injury.

### **⚠ CAUTION**

Indicates a hazardous situation that if NOT avoided, could result in minor or moderate injury.

### **NOTICE**

Indicates practices NOT related to physical injury

## 1.2 General Safety Message

### **⚠ WARNING**

- This unit MUST be installed and repaired by qualified personnel who are familiar with the risk involved.
- Do NOT modify this product in any way. Any modifications can be extremely hazardous.
- Keep electrical devices out of reach of children and do not allow them to operate the device without supervision.
- Only use accessories authorized by Velit.
- Do NOT use this unit in or near flammable environment.
- Do NOT let children use the unit without supervision

### **NOTICE**

- Do NOT use this unit when the ambient temperature is lower than 40°F. This could cause frost inside the unit.
- Do NOT power wash the unit or use detergent to clean the unit.

## 2. SPECIFICATIONS

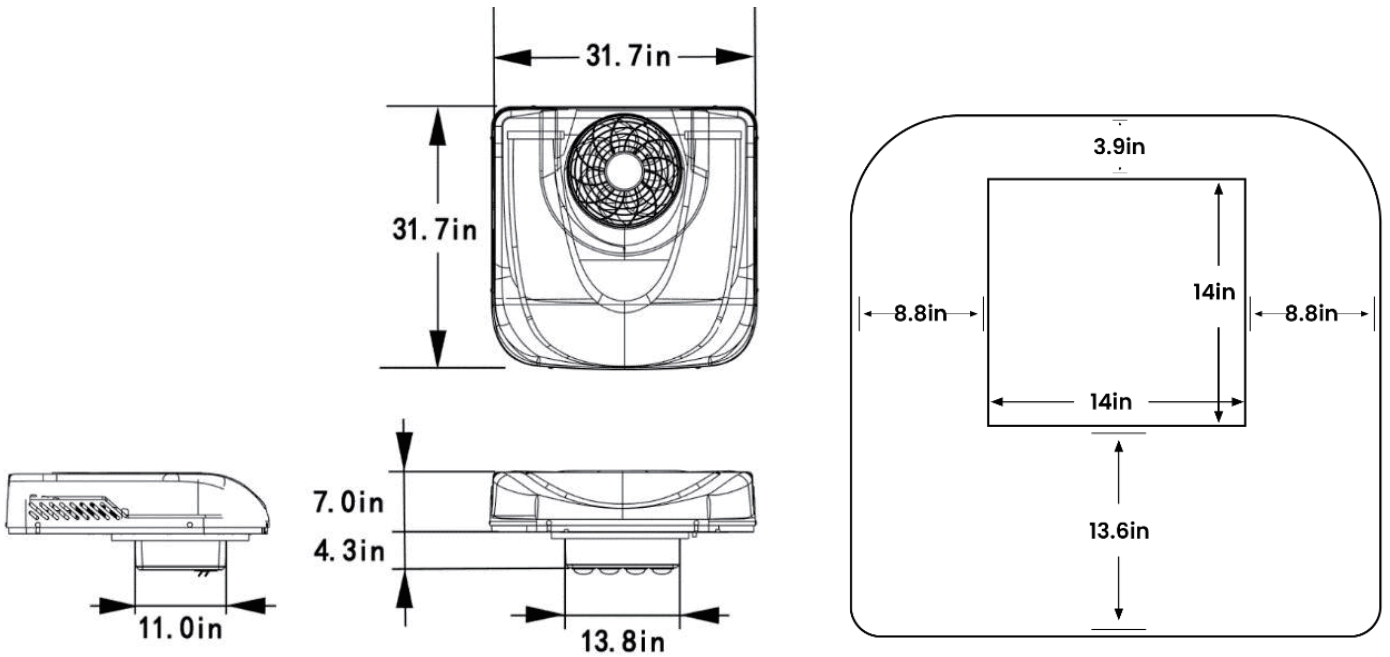

Model	2000R		
Input Voltage	DC12V	DC24V	DC48V
Operating Current	20-60A	10-40A	5-25A
Cooling Capacity	8000BTU	9500BTU	11000BTU
Operating Temperature	38-125°F / 0-52°C		
Rated Power	720W	720W	1300W
Refrigerant	R134a 750g		R410a 470g
Noise Level	ECO mode:55dB Boost mode:65dB		
Roise Unit Dimension	W 31.7" x L31.7" x H 7.1"		
Air Distribution Box Dimension	W 13.8" x L11" x H 4.3"		
Weight	66lb		



## 3. INSTALLATION

### 3.1 Choosing Proper Location for the Air Conditioner

#### **⚠ CAUTION**

- Route the 6AWG power cable to the roof opening. Leave at least 6 inches of slack. For cables longer than 15ft, refer to NEC (National Electric Code) for proper sizing of wire (12V 60A).

#### **⚠ WARNING**

Make sure to disconnect all power supplies to the vehicle including battery, generator, and shore power prior to installation.

- The unit can fit over an existing 14-1/4 by 14-1/4 roof opening. For other locations, make sure the slope of the select location is less than 15 degrees and leave a clearance of at least 10 inches from the edge of the roof. Refer to specifications for the dimension of the unit.
- After the location has been selected, check for obstructions in the area where the unit will be installed.
- Check the inside of the camper for decor panel obstructions. Allow 6 inches clearance from all edges of the opening.
- Route the 6AWG power cable to the roof opening. Leave at least 6 inches of slack. For cables longer than 10ft, refer to NEC (National Electric Code) for proper sizing of wire (12V 60A).

### 3.2 Attach the Sealing gasket to the Roof Opening

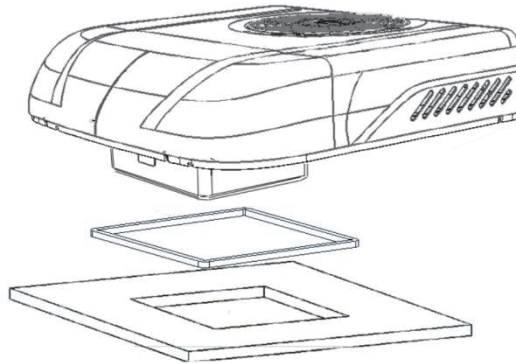

- Clean the surface between the unit and the roof where the sealing gasket will be installed.
- Apply sealant to the bottom of the sealing gasket. The sealant depends on the material of the roof.
- Place the sealing gasket on the roof opening.
- For better sealing, apply sealant to the edge where the sealing gasket contacts the roof.
- At the shown locations and other places if needed, stick the foam pieces between the unit and the roof to better support the unit

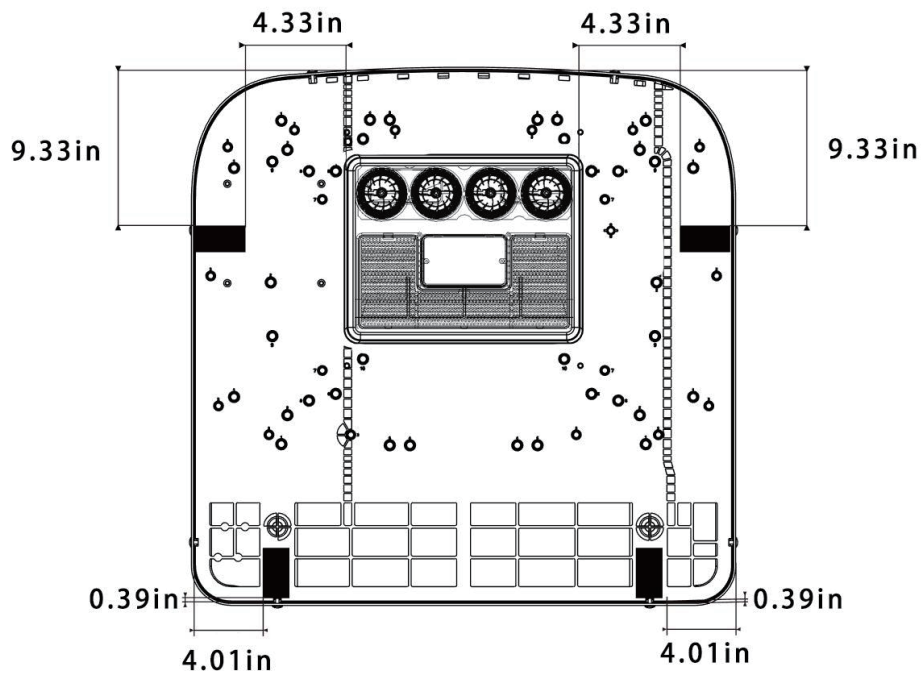

### 3.3 Place the Unit over the Roof Opening

- Grasp the bottom two sides of the unit, lift it and place it over the roof opening.
- Pull out the power cable.

### 3.4 Secure the Unit to the Mounting Brackets

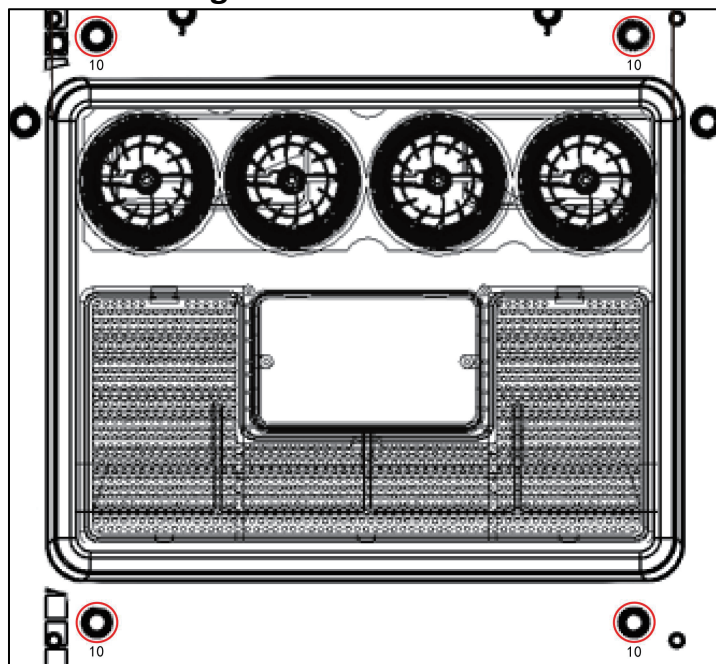

- Choose the proper length of M8 threaded rods based on roof thickness.
- Insert the threaded rods in the shown mounting holes (#10).
- Hand tightens four nuts all the way down to the bottom surface of the unit to secure the threaded rods

- Use the threaded rods as guidance, place the mounting brackets, and secure the brackets with provided washers and anti-slip nuts to 4.5-5.6NM (3.3-4.2 lb. Ft). Cut the threaded rods to desired length if needed.

**NOTICE** DO NOT OVERTIGHTEN!

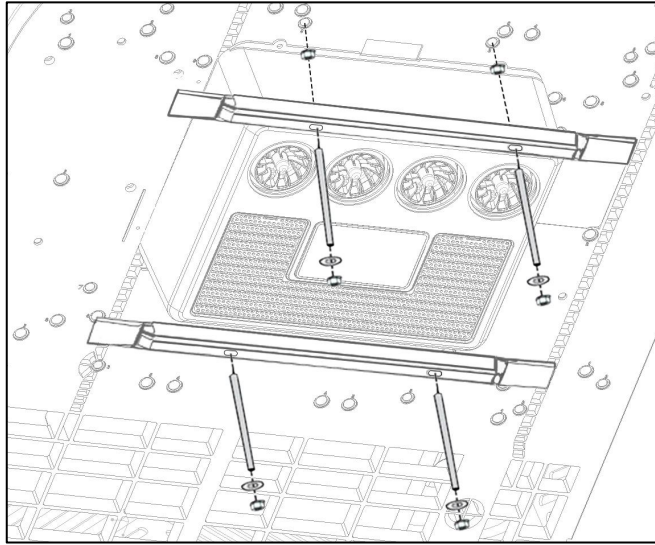

### 3.5 Connect Wiring

- Connect the power cable. On this end, the cable should have fuse boxes on both positive and ground.
- On the other end of the power cable, connect to the battery. On this end, there is only one fuse box on positive.

### 3.6 Install the Decor Panel

- Use the provided self-taping screws and washers to secure the decor panel to the roof.

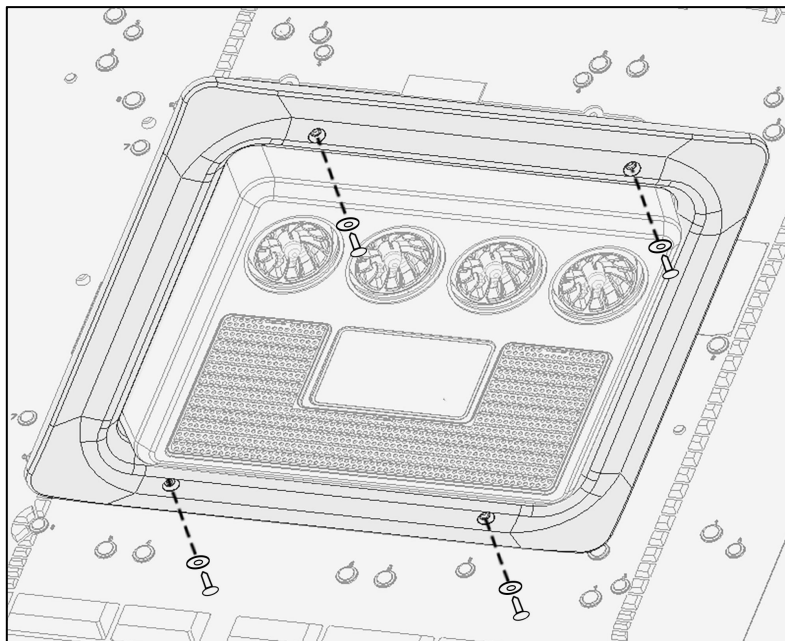

## 4. OPERATION

### 4.1 Modes

Mode changes only the compressor speed. Fan speed can be adjusted separately.  
Output from low to high:

Sleep : 

ECO : 

Cooling : 

TURBO : 

### 4.2 Control Panel



1 - Power ON/OFF: Short press to turn on unit. Long press 2s to turn off. Short press to turn off/on display while the unit is running

2 - Mode Switch: Short press to switch between operating modes:

Output from low to high output: Sleep, Eco, Cooling, Turbo

The mode only changes compressor speed. Fan speed can be adjusted separately.

3 - Fan Speed +: Increase fan speed













4 - Fan Speed -: Decrease fan speed

5 - Temperature +: Increase setting temperature

6 - Temperature -: Decrease setting temperature

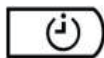
### 4.3 Remote Control

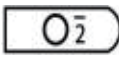
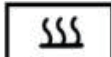
**NOTICE** This is a general-purpose remote. Some buttons do not apply to this model.

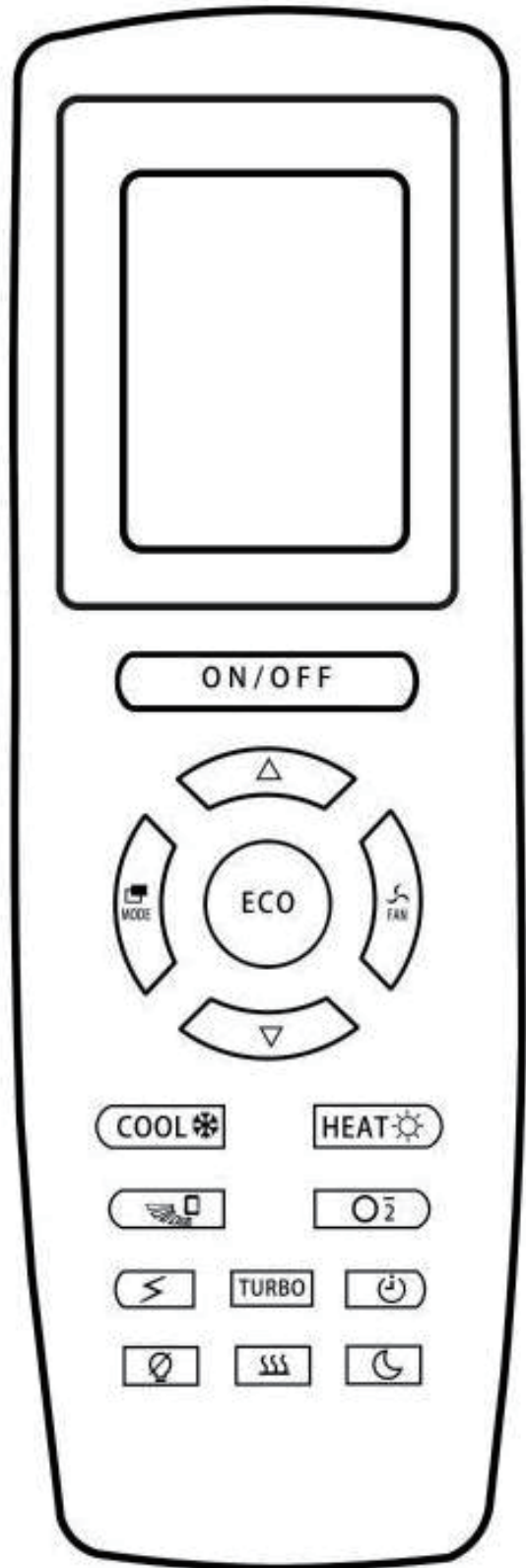

-  : Turn ON/OFF
-  : Switch between modes
-  : Change fan speed
-  : Increase temp
-  : Decrease temp
-  : Sleep mode
- ECO** : ECO mode
-  : Cooling mode
-  : Turbo mode
-  : View voltage
-  : Timer
-  : N/A
-  : N/A
-  : N/A
-  : N/A
-  : N/A



### 4.3 Switch Display Unit °C/°F

This feature is only available to units that come with display remote control.

Method 1: When the unit is on, long press the mode button on the display panel for 3s 

Method 2: When the unit is powered off, on the remote control, short press the mode  button and down arrowbutton  at the same time. The display unit on the remote will switch. Turn on the unit with the remote and the unit on the display panel will sync with the remote.

### 4.4 Under/Over-Voltage Protection

Low voltage protection will auto shut off the unit when the supplied voltage is lower than the cut-off voltage (default 10.5/21.5/40V) and the low-voltage red light will light up. The unit will turn on automatically once the supplied voltage is higher than the recover voltage (default 12/23/42V).

When the supplied voltage is higher than 18/36/72V, the unit will turn off and the high-voltage red light will light up. The unit will turn on automatically once the supplied voltage is lower than 15/30/60V.

### 4.5 Edit Low Voltage Protection

Long press the Mode button  Switch to edit low voltage protection.

Press Fan Speed +  to increase cut-off voltage.

Press Fan Speed -  to decrease cut-off voltage.

Press Temperature +  to increase recover voltage.

Press Temperature -  to decrease recover voltage.

Finally turn off the machine to save the settings 

## 5. TROUBLESHOOTING

### 5.1 Error code

There are multiple sensors built inside the unit. When an error is detected, the error icon will flash with the error code displayed. Check the table below for the meaning of the error codes and contact customer service when needed.

Code	Cause	Troubleshooting
E0	Ambient temperature sensor (White 2 pin connector)	Use a flathead screw driver to pry open the display panel. Ensure the white 2pin connector is seated properly. Replace the sensor or the display panel if needed
E1	Evaporator temperature sensor (Red 2 pin connector)	E1: Use a flathead screw driver to pry open the display panel. Ensure the red 2pin connector is seated properly. Replace the sensor or the display panel if needed.
E2	Over-current	Verify there is no short in the wiring harness. Make sure the outside fan and the side/bottom air inlet are not blocked. Rinse the condenser with water to clean off elements.
E3	Blocked rotor	Contact customer service
E4/EL	Low-voltage	Check the system and battery voltage. By default, this error code triggers when voltage drops below 10.5V. Make sure the wiring is connected properly and there is no loosed nuts or crimps
E5	Short protection/faulty controller	Contact customer service
E6/EH	Over-voltage	Check the system voltage. It should be less than 15V
E7	Compressor startup failure	Contact customer service
E8	Condenser fan	Make sure condenser fan connector is seated properly.
EF	Evaporator blower fan	Make sure the blower fan connector is seated properly. Pry open the display panel and make sure the fuse is intact.
Eb	Controller lack-phase	Contact customer service
EU	Controller overheated	Let the unit sit for ten minutes and restart the unit



## 5.2 Unit not cooling

Clean the inlet filter. Turn on the unit and measure the pressure at the low-pressure port. Use this chart to find the nominal pressure value based on the ambient temperature. If the pressure is lower than the nominal value, use a recharge kit (can be purchased from Auto part stores and Home Depot) to charge the unit to the desired pressure.

If there is grease and other sign of leakage, reach out to a technician to identify and fix the leak. Vacuum the system and charge with 650g of R134a /465g of R410a.

If your unit is charged with R410a, reach out to a professional to diagnose.

Ambient (Outside) Temperature °F	Standard Low Side Pressure Range PSI
65	25-35
70	35-40
75	35-45
80	40-50
85	45-55
90	45-55
95	50-55

## 5.3 Small rattling noise

Small rattling noise may be noticeable due to inconsistent temperature within the refrigerant. Increase the fan speed to mitigate the issue.