



OPERATING MANUAL

# PRO TIMER

Model # CEI 4720 **BT**



*Download the PT Link app!*

***Please read this manual!***

This manual contains setup information necessary to achieve proper performance from your ProTimer BT

 **Bluetooth**<sup>®</sup>



**Competition  
Electronics**

**THE WINNING DIFFERENCE!**

815.874.8001 • [competitionelectronics.com](http://competitionelectronics.com)

## Thank you for purchasing our product!

It is important to read and understand this manual before trying to use your new shot timer. We are here to help, if you have any questions or comments, please contact us at **815-874-8001** or [www.competitionelectronics.com](http://www.competitionelectronics.com).

The ProTimer BT is designed and built in the USA.  
With proper use and care it will give you many years of trouble-free service.

## Table of Contents

Battery Installation.....	1	Individual Screen Detail.....	7-13
Power ON/OFF.....	1	Review Shot String.....	7
Home Screen Information.....	2	Par Time.....	8
Control Button Functions.....	3-4	Start Delay Type.....	8
LED and Beeper Alerts.....	4	Backlight ON time.....	9
Headset Jack.....	5	Start Signal LED.....	9
Basic Operation.....	5	Beeper/Headset Volume.....	9
Shot Detection.....	5	Home Screen Type.....	9-10
Menu Flow List.....	6	Shot Dead Time.....	11
		Shot Sensitivity.....	11
		Date and Time.....	11
		Bluetooth.....	12
		Hit Factor Scoring.....	12
		Clear Data.....	13
		Review Previous string.....	13
		Battery Status, info, and warning screens.....	13-14
		Memory Info.....	14
		Resetting to Factory Defaults.....	14
		Firmware update.....	14
		Specifications.....	15
		Warranty.....	16

## Battery Installation

The ProTimer BT operates using a 9 volt battery for power. It is important to use Alkaline or Lithium batteries (not carbon) due to the power demand of the buzzer and display backlighting.

Install the battery in the compartment on the rear of the unit. Once installed, the ProTimer BT will briefly display a sign-on message, followed by the home screen.

**Note:** If at any time you suspect the unit is not functioning properly, try resetting it (see page # 14).

## Power ON/OFF

To turn the unit **ON**, press the **SET DECR/ON** button. After 10 minutes of inactivity, the ProTimer BT will turn off automatically.

You may also turn it **OFF** by pressing the **MENU REV/OFF** button for approximately 3 seconds.

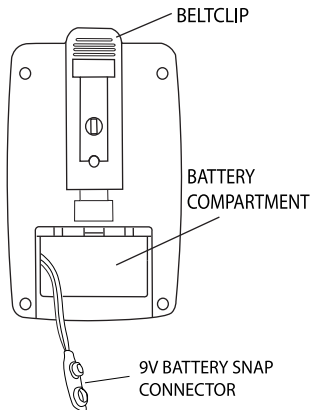

## Home Screen

This screen is the default style which shows the time to last shot, time to the first shot, current split time, shot number, and date/time.

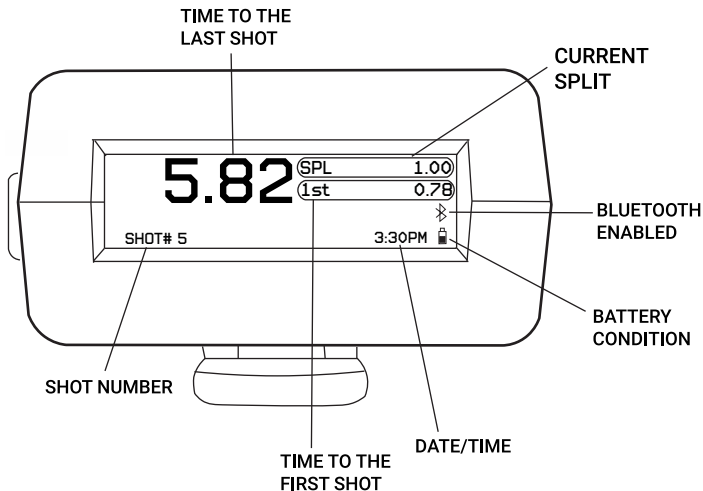

**Note:** You can choose from two other screen configurations as shown on page # 10

## Control Button Functions

### START BUTTON

(Located on the side of the unit), Press to start a new timing event. The timing begins from the moment the beeper sound is activated.

### MENU BUTTONS

(Marked on the front of the unit **FWD** and **REV**), these buttons navigate back and forth through the continuous menu loop.

From the **HOME** screen, the **FWD** button will advance to the more commonly used features, and the **REV** button will advance to the less common features. Once you become familiar with the **MENU** navigation, you will learn which direction is the fastest route to find a particular setting.

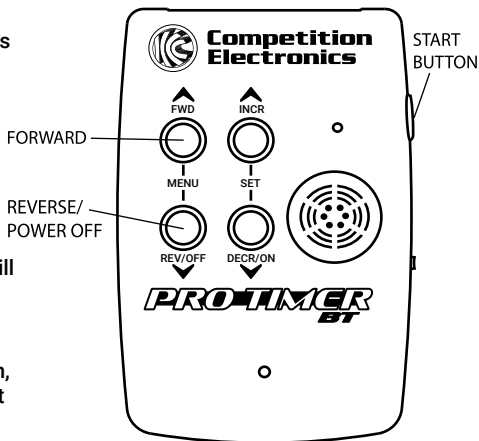

# PRO TIMER BT

## SET BUTTONS

(Marked on the front of the unit **INCR** and **DECR**), these buttons change a setting that is flashing on one of the menu screens.

**Note:** On screens that have a large settable range, you can hold down the button to automatically advance the digits, and press both **SET** buttons simultaneously to clear the setting.

## LED & Beeper Alerts

The ProTimer BT has two indicators for signaling an event. They are both active with the default settings, but can be turned off if desired within the menu settings.

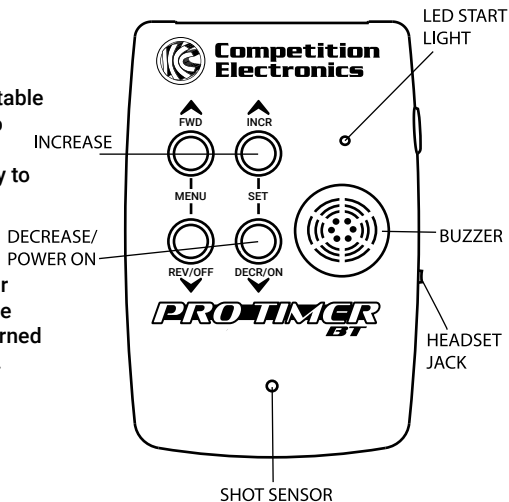

## Headset Jack

A standard 3.5mm stereo headset jack is located on the side of the unit. The Piezo beeper is disabled when a headset is connected for a private practice session. The beeper volume control will also change the headset volume level.

## Basic Operation

If you haven't done so already, advance through the 14 menu screens and make any adjustments to the default settings to suit your needs.

- The active settable value will be flashing.
- Some of the screens have more than one settable value, which will require multiple presses of the menu button to advance.
- When changing a setting with the **SET** buttons, if you hold the button, it will advance the digits automatically
- Settings are automatically saved.

Pressing the **START** button from all screens (except Clear Data) will return to the home screen and begin a new string.

## Shot Detection

Each time a shot is detected, it will be added to the shot string. If you navigate away from the home screen, the ProTimer BT will stop detecting shots until the start button is pressed. The ProTimer BT will automatically calculate the split time, which is the time between the current shot and the previous shot. The ProTimer BT can store up to 70 shots per string. Subsequent shots will be stored by overwriting the previous value of shot number 70. If the timer reaches 600 seconds, a "maximum time limit exceeded" message will appear.



## Menu List

Moving forward from the home screen, here is the order of menu screens and a brief description. More detail for each is provided later in this manual.

- **Review shot string:** shot number, time, and split information
- **Par time:** settable for up to 5 par time beeps
- **Start Delay Type:** Instant, fixed, or random
- **Backlight ON time:** LCD backlight duration
- **Start signal LED:** enable/disable the start LED
- **Beeper volume:** adjust headset and beeper volume
- **Home screen type:** select from three configurations
- **Shot dead time:** used for echo control indoors
- **Shot sensitivity:** increase or decrease the shot sensitivity
- **Date:** setting for review direct screen and date stamp of shot strings
- **Time:** setting for review direct screen and time stamp of shot strings
- **Bluetooth:** enable/Disable bluetooth transmitter
- **Hit Factor Scoring:** Enter target points for hit factor
- **Clear data:** erase unwanted strings
- **Review previous string:** recall up to 50 previous strings

## Individual Menu Screen Detail

### Review Shot String

From the home screen, pressing **MENU/FWD**, **SET/INCR**, or **SET/DECR** will advance to the review screen. Shots will be displayed on the shot review screen in a “one shot per line” format. Reading from left to right, the shot time appears first, followed by the shot number, and finally the split time.

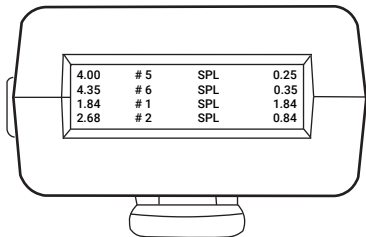

When navigating to the review shot screen after the completion of an event, the first shot will appear on the 3rd line, and the last shot will appear on the 2nd line - if there are 4 or more shots in the string. This is intended for the user to quickly locate the first and last shot information without keystrokes.

Use the **SET-INCR/DECR** buttons to scroll through the shot string to review if there are more than 4 shots in the list.

## Par time

The par time settings create multiple beeps based on time intervals from the start beep. The ProTimer BT has the capacity for up to 5 par times which will automatically occur at the user settable time interval for each. The default settings are zero for all 5 par time settings, which effectively turns them off, so in this case there will be only the start beep at the beginning of an event.

Setting the first par time to a value other than zero will give you a beep at the start, and another at the end of the par time period. Setting of par times 2 through 5 will string the beeps together in order. When a value of zero is set in any of the par time locations, it will halt any subsequent values from being active. Par time is adjustable from 0 to 600 seconds.

## Start Delay Type

The start delay can be configured for instant, fixed, or a random value based on a minimum/maximum time frame from the start beep.

**INSTANT**- The default setting of INSTANT will start a new shot string immediately upon pressing the start button.

**RANDOM**- Changing the setting to RANDOM will enable the minimum and maximum values to appear on the screen. The settable range is from .10 seconds to 9.90 seconds.

**FIXED**- If the RANDOM values are both set for the same amount of time, the delay will be FIXED at that value.

## Backlight ON Time

The display backlighting can be set for a specific amount of time to remain ON after pressing a button.

The settable range is 0 to 99 seconds. Longer time intervals will reduce battery life.

## Start Signal LED

The LED indicator on the front of the unit can be enabled/disabled by pressing one of the SET buttons.

This feature is intended for use when hearing the beeper is difficult, but could also be considered as an alternative method for beginning a stage.

## Beeper/Headset Volume

The volume control for beeper and headset volume can be adjusted from OFF to maximum with 10 levels.

## Home Screen Type

There are 3 home screen configurations to choose from.

- Review Direct
- Single Time Only
- Rounds Per Minute

# PRO TIMER BT

## REVIEW DIRECT (DEFAULT HOME SCREEN)

This selection is the default setting which shows more information with the penalty of a smaller "time to the last shot". The time to the first shot, current split time, and date/time are all included on this screen.

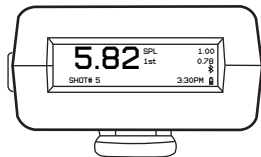

---

## SINGLE TIME ONLY

This selection will show only the time to the last shot in a large format.

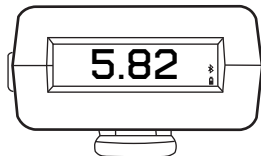

---

## ROUNDS PER MINUTE

This mode is used for measuring the rate of fire rather than time intervals. The screen layout is similar to [REVIEW DIRECT](#). After the start beep, fire shots; the timer will display the rounds per minute based on the number of shots and the time between the first and the last shot. Shots will stop being recorded once the timer has reached 600 seconds. The ProTimer BT can detect shots at rates up to 1800 RPM.

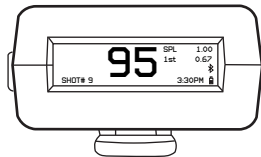

## Shot Dead Time

The SHOT DEAD TIME feature is used to reduce false shot recordings due to echoes or ringing normally associated with indoor use. Once a shot is detected, the ProTimer BT will disregard subsequent shots (echoes) for a short period of time. The default setting is .11 seconds, but can be adjusted from .05 to .12 seconds. If your split time between shots is less than .11 seconds, an adjustment will be necessary.

## Shot Sensitivity

The sensitivity adjustment range is from 0 (lowest) to 25 (highest). The default setting of 13 will work with most types of firearms. With the high range settings, keep in mind that there may be false shot detection from handling or other noise sources.

## Date and Time

Settings for the date and time are entered on two screens and are displayed on the **REVIEW DIRECT**, and **ROUNDS PER MINUTE** home screens. It is also recorded for reference when a shot list is stored in the shot string memory.

## Bluetooth

The ProTimer BT has built-in Bluetooth capability and can be linked with modern mobile devices. The Bluetooth transceiver can be enabled/disabled by pressing one of the **SET** buttons from the Bluetooth enable screen.

- To pair, start by searching your app store for “CE PT Link” and install the app.
- Open the app, read and follow the on screen tutorial.
- Be sure that your unit is powered on and the Bluetooth is enabled.
- Tap the “connection” button in the app menu to initiate the pairing process.
- Once the unit has successfully paired, tap “ProTimer Settings” and remotely adjust your timer’s settings to your preference.
- You are now ready to shoot!
- Once you have finished shooting, swipe down on the screen or tap the refresh arrow to import your shots.
- It is recommended to turn the ProTimer BT’s Bluetooth off when not in use to conserve battery.

**\*NOTE:** It is not possible to transmit start tone to Bluetooth headsets.

Check out our website at [www.competitionelectronics.com](http://www.competitionelectronics.com) for up-to-date information about our apps.

## Hit Factor Scoring

In order to obtain the Hit Factor (points per second) score, first you must complete a stage to record the time to the last shot, then enter values for TOTAL STAGE POINTS and POINTS DOWN on the Hit Factor Scoring screen.

The score will automatically be calculated on the top line of the display. You can adjust the time to the last shot value in order to see how the score is affected by a different amount of time.

## Clear Data

Use the Clear Data screen to delete unwanted strings by pressing the START button. This cannot be reversed!

## Review Previous String

Previous strings of fire can be recalled for review by selecting one of the flashing numbered values on the Review Previous String screen. The corresponding date and time stamp will be updated as the number is changed. The unit will store up to 50 strings, with up to 70 shots per string along with the Hit Factor scoring data. If the max number of strings is exceeded, the first (oldest) string will be purged.

## Battery status, info and warning screens:

The battery icon shown on the display will appear as:

- FULL from 8.4 to 9.5 volts
- 1/2 from 7.8 to 8.3 volts
- EMPTY from 7.3 to 7.7 volts
- FLASH/EMPTY from 6.5 to 7.2 volts

A “backlight disable” message will appear when the unit is powered ON and the battery is low. This will conserve power in case a new battery is not readily available.

A “low battery critical warning” message will appear when the unit is powered ON and the battery is too low for operation. The unit will shut down and a new battery will be necessary for continued use.



## Battery Life and power consumption

When the ProTimer BT is powered OFF, a very small amount of power (approximately 40 microamps) is consumed in order to retain the date/time clock settings. If the unit will be put in storage for several months or more, it is recommended to remove the battery to avoid unnecessary loss of battery life. The only penalty is that the date and time will have to be reset. The calculated lifespan of a (new) 600mA alkaline battery in sleep mode is 800 days. A lithium battery has a typical rating of 750mA. Under normal use, a lithium battery will provide approximately 30 hours of service and an alkaline battery will provide approximately 25 hours of service.

## Memory info

The ProTimer BT will retain up to 50 shot strings, with up to 70 shots per string, and all settable values in non-volatile memory, along with hit factor scoring. This means that they will not be lost during battery changes. If the maximum number of strings is exceeded, the oldest string will be purged automatically.

## Resetting to Factory Defaults

To restore the factory default settings, hold down the start button, connect the battery, and look for “initializing” message on the display. Release the start button and follow the on-screen prompt to complete the process.

## Firmware Update

Provisions have been made to update the unit firmware from the mobile apps. See the PT Link app for more details.

## Specifications

- Operating Temperature: 30-110 degrees Fahrenheit
- Accuracy: +/- .01 seconds
- Max # of Shots Per String: 70
- Max # of Strings in Memory: 50
- Max # of Rounds per Minute: 1800
- Max # of Par Time Beeps: 5
- Start Delay Range: .1 to 9.90 seconds
- Backlight On Time Range: 0-99 seconds
- Beeper Output: 1.5 Khz, 100dB, 200 msec duration
- LED Output: 850 mcd, 200 msec duration
- Max Time Limit: 600 seconds
- Average Battery Life: 25 hours of operation
- Power Consumption: See page 14
- Battery Type: 9 volt alkaline or lithium
- Bluetooth: BT2 & BT4 - Dual Mode, min 50ft range

## Limited Warranty

\*\*\*\*\*

COMPETITION ELECTRONICS, INC., warrants the ProTimer BT manufactured by it to be free from defects in material and workmanship for a period of 2 years from date of purchase by the original purchaser for use. COMPETITION ELECTRONICS, INC., at its option, will repair or replace without charge, or refund the purchase price of, any product which fails during the warranty period by reason of a defect in material or workmanship found upon examination by COMPETITION ELECTRONICS, INC., to have been the cause of the failure. This warranty does not cover any failures attributable to abuse, mishandling, and failure to follow operating instructions, alteration or accident. To make claim under this warranty, the purchaser must return the product to COMPETITION ELECTRONICS, INC., at the address shown below, properly packed and with shipping charges prepaid. All claims must be made within (30) days after the product failure and, in any event, within thirty (30) days after the expiration of the 2-year warranty. All claims must be accompanied by a sales slip or other written proof of date of purchase.

TO THE EXTENT PERMITTED BY LAW, ANY AND ALL IMPLIED WARRANTIES, INCLUDING MERCHANTABILITY AND FITNESS FOR PARTICULAR PURPOSE, ARE EXCLUDED; ANY IMPLIED WARRANTIES NOT EXCLUDED ARE LIMITED IN DURATION TO 2 YEARS FROM DATE OF PURCHASE. INCIDENTAL AND CONSEQUENTIAL DAMAGES ARE EXPRESSLY EXCLUDED FROM THE REMEDIES AVAILABLE TO THE PURCHASER, AND THE REMEDIES PROVIDED IN THIS WARRANTY SHALL BE EXCLUSIVE TO THE EXTENT PERMITTED BY LAW.

(Note: Some states do not allow limitations on how long an implied warranty lasts or the exclusion or limitation of incidental or consequential damages, so the foregoing limitations and exclusions may not apply to you. This warranty gives you specific legal rights, and you may also have other rights which vary from state to state.) If any product returned by the purchaser is found by COMPETITION ELECTRONICS, INC., to require service not covered by warranty, COMPETITION ELECTRONICS, INC., will so advise the purchaser and request further instructions. COMPETITION ELECTRONICS, INC., will recondition to working order any ProTimer BT returned to it regardless of condition upon the purchaser's remittance of payment of 1/2 of current retail price, if it is still manufactured by COMPETITION ELECTRONICS, INC.

\*\*\*\*\*

### Return Shipping Address:

Competition Electronics, Inc.  
3469 Precision Dr.  
Rockford, IL 61109

### Contact Us:

Phone: 815-874-8001  
FAX: 815-874-8181  
competitionelectronics.com

# ***PRO TIMER***

OPERATING MANUAL

***BT***



**Competition Electronics**

[www.competitionelectronics.com](http://www.competitionelectronics.com)

**815.874.8001**

REV 8 2023