

# Competition Electronics, Inc



## Turbo35-GFX/LiPo

### User's Manual and Guide to Electric R/C Racing

**Competition Electronics, Inc**

**3469 Precision Dr.**

**Rockford, IL 61109**

# TABLE OF CONTENTS

<b><u>INTRODUCTION TO THE T35-GFX: A TOOL TO MEASURE AND CONDITION YOUR CELLS.....</u></b>	<b><u>7</u></b>
<b><u>WARNING.....</u></b>	<b><u>7</u></b>
<b><u>SPECIAL CONSIDERATIONS FOR LIPO MODE USE.....</u></b>	<b><u>7</u></b>
<b><u>WARNING: PLEASE READ BEFORE USING YOUR TURBO35-GFX LIPO CHARGER/DISCHARGER:.....</u></b>	<b><u>7</u></b>
CARING FOR BATTERY .....	9
OPERATING TEMPERATURE .....	9
<b><u>CONNECTING THE TURBO35-GFX LIPO TO A LIPO PACK.....</u></b>	<b><u>9</u></b>
SENSE LEADS.....	9
MAKING THE PROPER CONNECTIONS WHEN CHARGING OR DISCHARGING A LIPO PACK.....	10
IMPORTANT: USING AN EXTERNAL BALANCER WITH THE T35-GFX LIPO.....	11
FINAL NOTES ABOUT BALANCERS.....	13
BALANCING WITH THE TURBO35-GFX ALONE.....	13
<b><u>HOW TO USE THIS MANUAL.....</u></b>	<b><u>13</u></b>
<b><u>QUICK START: A STARTING LINE VIEW OF THE T35-GFX.....</u></b>	<b><u>13</u></b>
PREPPING THE T35-GFX FOR USE.....	13
POWERING UP THE T35-GFX.....	14
GETTING FAMILIAR WITH THE T35-GFX MENU SYSTEM.....	14
THE MODE INDICATOR LINE.....	16
LOADING FACTORY SETUPS.....	16
CONNECTING YOUR PACK AND MOTOR.....	17
<b>QUICK START: NIXX OR LIPO SELECT.....</b>	<b>18</b>
<b>QUICK START: CHARGE.....</b>	<b>18</b>
<b>QUICK START: DISCHARGE.....</b>	<b>18</b>
<b>QUICK START: CYCLE.....</b>	<b>18</b>
<b>QUICK START: MOTOR RUN.....</b>	<b>18</b>
<b><u>LEARNING ABOUT CELLS AND PACKS FOR R/C RACING.....</u></b>	<b><u>19</u></b>
TYPES OF CELLS USED IN R/C RACING.....	19
RC RACING IS DIFFERENT FROM OTHER BATTERY APPLICATIONS.....	19
HOW CAN CELL AND PACK CAPACITY BE MEASURED AND COMPARED?.....	20
SETTING UP TESTS AND COMPARING DATA.....	20
BALANCING.....	20
Single Cell Testing.....	21

To RECAP...	22
USEFUL PARAMETERS FOR MEASURING PERFORMANCE.....	22
Actual Internal Resistance.....	22
Peak Charge Volts.....	22
Discharge Average Volts.....	22
Discharge Average Volts at 1V.....	22
Run Time.....	23
mAHr.....	23
mWHR.....	23
Relative Internal Resistance.....	23
<b>MAXIMIZING PERFORMANCE: WHAT HELPS, WHAT DOESN'T.....</b>	<b>23</b>
UNDERSTANDING CELL RATING AND MANUFACTURER'S SPECIFICATIONS.....	23
Charge and Discharge Rates and the "C" Rating.....	24
HOW TO DETERMINE STARTING POINTS FOR CHARGE RATES, DISCHARGE RATES, AND PEAK DETECT SETTINGS FOR NIMH/NICd CELLS AND PACKS.....	24
Charging.....	24
Peak Detect.....	25
False Peaking.....	25
Cell Heating.....	25
Cell "Venting".....	26
TurboFlex: What is it and what does it do?.....	26
Discharging.....	26
Discharge Rate and It's Relationship to Performance.....	26
Nimh/NiCd Cell Matching and it's Effects.....	27
Charging LiPo Packs.....	27
Discharging LiPo Packs.....	28
USING SIMULATED DISCHARGE PROFILES TO CONDITION NIMH/NICd PACKS.....	29
ZAPPING: WHAT IS IT AND WHAT DOES IT DO?.....	29
EXTREME NIMH/NICd DISCHARGE/EQUALIZING.....	29
GETTING THE MOST OUT OF YOUR CELLS DEPENDS ON DRIVING SKILL.....	30
LiPo CAUTIONS:.....	30
HMMM: IT SOUNDS COOL, BUT IS IT USEFUL? GIMMICKS, TRENDS AND SUPERSTITION.....	30
<b>FINAL ADVICE (FOR NOW...)</b> .....	<b>30</b>
<b>RESOURCES ON THE WEB</b> .....	<b>30</b>

**THE T35-GFX IN DETAIL.....31**

**WHAT CAN I DO WITH MY T35-GFX?.....31**

<b>THE MODE BUTTON.....</b>	<b>32</b>
<b>THE PAGE BUTTON.....</b>	<b>32</b>
<b>THE START/STOP BUTTON.....</b>	<b>33</b>
<b>THE ROTARY DIAL SWITCH AND THE CURSOR.....</b>	<b>33</b>
<b>REINITIALIZING NON-VOLATILE MEMORY.....</b>	<b>33</b>
<b>NIMH/NICd CHARGE MODE.....</b>	<b>34</b>
CHARGE POWER DISSIPATION LIMIT.....	34
SETTING UP A CHARGE CYCLE.....	34
Charge Rate.....	34
Peak Detect Voltage.....	35

TurboFlex On/Off.....	35
TurboFlex Level.....	35
Long Lockout On/Off.....	35
# of Peaks.....	35
Delay.....	36
Interpreting the Results.....	36
Peak Volts.....	36
mAHr.....	36
Charge Time.....	36
Other Features.....	36
Trickle Charge.....	36
Delayed Start.....	36
Miscellaneous Features and Functions.....	36
Adjusting Charge Rate during a Charge Cycle.....	36
<b>LiPo CHARGE MODE.....</b>	<b>36</b>
SETTING UP A LiPo CHARGE CYCLE.....	37
<b>MAX CHARGE SECONDS.....</b>	<b>37</b>
<b>NO OF CELLS.....</b>	<b>37</b>
<b>CHARGE MAHRS.....</b>	<b>37</b>
<b>UNDER AND OVERVOLTAGE CONSIDERATIONS.....</b>	<b>37</b>
Viewing the Charge Graph.....	38
<b>NiMH/NiCd DISCHARGE MODE.....</b>	<b>38</b>
DISCHARGE POWER DISSIPATION LIMIT.....	38
SETTING UP A DISCHARGE CYCLE.....	38
Discharge Amps.....	38
# of Cells.....	39
Discharge Profile Mode.....	39
Cutoff Voltage.....	39
AIR ON/OFF.....	40
<b>LiPo DISCHARGE MODE.....</b>	<b>40</b>
SETTING UP A DISCHARGE CYCLE.....	40
Discharge Amps.....	40
# of Cells.....	40
AIR ON/OFF.....	40
<b>UNDER AND OVERVOLTAGE CONSIDERATIONS.....</b>	<b>40</b>
Interpreting the Results.....	41
Discharge or Run Time.....	41
mAH.....	41
mWH.....	41
Average Discharge Volts.....	41
Average Discharge Volts at 1 Volt.....	41
Actual Internal Resistance.....	41
Other Features.....	42
Viewing the Discharge Graph.....	42
<b>CYCLE MODE.....</b>	<b>42</b>
SETTING UP A CYCLE.....	42
# of Cycles.....	42
Cool Down Minutes.....	43
Relative Internal Resistance.....	43

**CYCLING WITH THE TURBO-GFX LIPO.....43**

**MOTOR RUN MODE.....43**  
SETTING UP THE MOTOR RUN CYCLE.....43  
Motor Volts.....43  
Run Time Minutes.....43  
Using the GFX with a Commutator Lathe.....43  
Adjusting Motor Voltage While Running.....43  
**DATA MODE.....44**  
COMM SETTING.....44  
MAN(ual) and AUTO(matic).....45  
GRAPH MAN and GRAPH AUTO.....45  
COMP MAN and COMP AUTO.....45  
REAL TIME.....45  
The Serial Port.....45  
Hardware Configuration Details.....45  
Communications Configuration Details.....46  
Real Time Data Format.....46  
Interfacing an ASCII printer.....47  
USING THE GRAPHING FEATURES.....49  
Data Collection and Storage.....50  
Using the Cursor.....50  
SUPPLY VOLTAGE.....50  
**SETUP MODE.....50**  
WHAT SETTINGS ARE SAVED/RECALLED IN A SETUP?.....50  
General.....50  
Charge.....50  
Discharge.....51  
Cycle.....51  
Motor.....51  
**STORING/RETRIEVING SETUPS.....51**  
LOADING SETUPS.....52  
SAVING SETUPS.....52  
NAMING/RENAMING SETUPS.....53  
EDITING SETUPS.....53  
BEEPER.....53  
MACHINE.....54  
TurboLabel Output.....54  
Using TurboLabel with the T35-GFX.....54  
TurboLabel Computer Data Format.....54  
USING THE PC AND HELPER PROGRAMS.....55  
HyperTerminal.....56  
HYPERTERMINAL QUICK START.....56  
CAPTURING AND SAVING DATA.....57  
Tera Term.....60  
Excel®.....60  
Open Office.....64

**SPECIFICATIONS.....65**

<b>POWER SUPPLY REQUIREMENTS.....</b>	<b>65</b>
<b><u>WHEN IT DOESN'T WORK.....</u></b>	<b><u>66</u></b>
<b>COMMON PROBLEMS AND QUESTIONS.....</b>	<b>66</b>
NONVOLATILE MEMORY CORRUPTION.....	66
FAILURE TO POWER UP CORRECTLY; GARBLED DISPLAY .....	66
FUSES.....	67
VOLTAGE DROP, RESISTANCE, AND THE PROPER USE OF SENSE LEADS.....	67
SHOULD I SEND MY T35-GFX IN FOR CALIBRATION?.....	68
<b>SENDING YOUR T35-GFX IN FOR REPAIR.....</b>	<b>68</b>
<b>FIRMWARE UPDATES.....</b>	<b>68</b>
<b>***LIMITED WARRANTY***.....</b>	<b>69</b>
<b>HOW TO CONTACT COMPETITION ELECTRONICS.....</b>	<b>69</b>

## **Introduction to the T35-GFX: A Tool to Measure and Condition your Cells**

Congratulations on your purchase of our Turbo35 GFX! The T35-GFX is a state-of-the-art, competition-grade battery charger/discharger/motor run machine. If you are new to the T35-GFX it will take a while to become fully familiar with its many advanced features. However, the T35-GFX is designed so that its basic functions are easy to use, right out of the box.

If you've used other CEI products, you'll feel right at home with the T35-GFX. However, if you've used earlier CEI products, you'll find that the T35-GFX also has many new, exciting and useful features that you won't find on our competitor's products.

In order to get the most out of your T35-GFX, please take some time to familiarize yourself with this manual.

### **Warning**

To reduce the risk of injury, use only rechargeable nickel cadmium or nickel metal cells and packs, or 1S-3S LiPo packs with the T35-GFX. Any other type of battery may burst and cause personal injury.

DO NOT leave the T35-GFX unattended. The remote possibility of an electronic failure could cause extreme overcharge. This could cause a cell to burst and cause a fire hazard.

The T35-GFX is designed to provide data about rechargeable nickel cadmium, nickel metal and LiPo batteries. In order to simulate high discharge rates obtained during racing, the T35-GFX is designed to discharge at high currents. While the methods used in the T35-GFX are common in selecting cells, excessive heat generated during the process may cause damage to the cells or cause them to vent corrosive fluids. To reduce the risk of injury, ALWAYS WEAR SAFETY GLASSES when operating the T35-GFX. Since the cells can and do become extremely hot, be careful not to handle the cells until cooled.

Always make sure all the cells in the pack are in the same state of discharge before charging a pack. Otherwise, the cells that are partially charged before charging will get extremely hot and may be damaged or vent corrosive fluids. LiPo packs may burst into flames or explode if charged or discharged improperly.

Check your battery pack occasionally for overheating. If the cells are too hot to touch, there is something wrong and the pack must be disconnected from the charger.

Competition Electronics, Inc. shall not be liable for any property damage or personal injury which may result from the failure to follow these instructions or other improper use of this product.

## **Special Considerations for LiPo Mode Use**

### **WARNING: Please read before using your Turbo35-GFX LiPo charger/discharger:**

#### **IMPORTANT SAFETY INSTRUCTIONS AND WARNINGS**

- You must read these safety instructions and warnings before using the Turbo35-GFX LiPo battery charger.
- Lithium Polymer batteries are volatile. Failure to read and follow the below instructions may result in fire, personal injury and damage to property if charged or used improperly.
- Competition Electronics, Inc, its distributors or retailers assume no liability for failures to comply with these warnings and safety guidelines.

#### General Guidelines and Warnings

1. Use only the LiPo mode, never the NimH/NiCd mode, to charge and discharge LiPo batteries. Failure to do so may cause a fire, which may result in personal injury and property damage. Likewise, do not attempt to work with NimH/NiCd packs in LiPo mode.
2. Always use the sense leads. LiPo operations require precise voltage sensing; damage to LiPo packs may occur if you fail to use the sense leads.
3. Never charge batteries unattended. When charging LiPo batteries you should always remain in constant observation to monitor the charging process and react to potential problems that may occur.
4. If at any time you witness a battery starting to balloon or swell up, discontinue the charging process immediately, disconnect the battery and observe it in a safe place for approximately 15 minutes. This may cause the battery to leak, and the reaction with air may cause the chemicals to ignite, resulting in fire.
5. Since delayed chemical reaction can occur, it is best to observe the battery as a safety precaution. Battery observation should occur in a safe area outside of any building or vehicle and away from any combustible material.
6. Wire lead shorts can cause fire! If you accidentally short the wires, the battery must be placed in a safe area for observation for approximately 15 minutes. Additionally, if a short occurs and contact is made with metal (such as rings on your hand), severe injuries may occur due to the LiPo pack's ability to supply massive amperage.
7. A battery can still ignite even after 10 minutes.
8. In the event of a crash, avoid any charging or discharging of a LiPo battery until you have placed it in a safe open area away from any combustible material and observed it for approximately 15 minutes.
9. Never store, charge or discharge battery pack inside your car in extreme temperatures, since extreme temperature could ignite fire.
10. Monitor the condition of your LiPo packs and discontinue use when performance degrades or changes significantly.
11. OBSERVE PROPER POLARITIES BETWEEN CHARGER AND PACK WITHOUT FAIL.

## Charging/Discharging Process

1. Never charge/discharge batteries unattended.
2. Charge or Discharge in an isolated area, away from other flammable materials.
3. Let battery cool down to ambient temperature before charging.
4. Do not charge/discharge battery packs in series. Charge each battery pack individually. Failure to do so may result in incorrect battery recognition and charging functions. Overcharging may occur and fire may be the result.
5. When selecting the cell count or voltage for charging purposes, select the cell count and voltage as it appears on the battery label. As a safety precaution, confirm the information printed on the battery is correct.
6. Selecting a cell count other than the one printed on the battery (always confirm label is correct), can cause fire.
7. You must check the pack voltage before charging/discharging. It is not advisable to attempt to charge any pack if open voltage per cell is less than 3.3v. If you insist and the per cell voltage is greater than 2.3 volts, the Turbo35-GFX LiPo will charge the pack at a reduced current for 2 minutes in an attempt to reach at least 3V per cell. However, chances are the pack is damaged and will need replacement.
8. CEI recommends charging at 1C rate or less (mAHr capacity of the battery/1000 in units of amperes), unless the manufacturer specifically recommends otherwise.
9. Do not discharge battery to a level below 3V per cell under load. Deep discharge below 3V per cell can deteriorate battery performance.

## ***Caring for Battery***

1. Use caution to avoid puncture of the cell. Puncture of cells may cause a fire.

## ***Operating Temperature***

Typical Charge temperatures: 32 to 113 degrees F

Typical Discharge temperatures: 32 to 140 degrees F

1. Consult the specific manufacturer's data sheet for temperature data before charging or discharging a LiPo battery.
2. Let battery cool down to an ambient temperature before charging.
3. During discharge and handling of batteries, do not exceed 160 degrees F.

## **Connecting the Turbo35-GFX Lipo to a LiPo Pack**

The hazards to both the battery and operator associated with shorting out or reversing polarity to LiPo packs make it essential that care is taken with connections between the Turbo35-GFX LiPo and the pack. Smaller packs, such as transmitter packs or packs used for airplanes often come with a pin and socket type connector, or a Dean's connector already assembled to the pack. If the connector ampacity is sufficient for the discharge rate, it is suggested that you obtain a mating connector and affix it to the GFX contacts in such a way that no short or polarity reversal is possible.



Larger packs such as those intended for R/C cars, often have low resistance, gold-plated barrel-type connectors. In this case, CEI recommends obtaining the proper mating connectors and connecting them to the Turbo35-GFX LiPo output leads in such a way that shorting of the pack is not possible. In this case, it is recommended that similar proper mating connectors be directly attached to the Turbo35-GFX LiPo output leads.

For convenience, you can use suitable connectors, such as Dean's connectors, on the sense and power leads. Then, make plug-in harnesses for different pack types; terminate the NimH/NiCd harness with the usual large and small alligator clips. Terminate the LiPo harness with a pair of high quality barrel connectors specifically designed to mate with the LiPo pack.

CEI DOES NOT recommend using alligator clips or any dissimilar connector to directly connect to the LiPo pack's recessed terminals. In addition, avoid lots of floppy alligator-clipped connections with LiPo packs. Make the connections as simple as possible, and as short as practical.

### ***Sense Leads***

ALWAYS USE THE SENSE LEADS WITH LiPo PACKS.

If your pack has high current barrel connectors such as those mentioned above, then it is best if you mate the sense leads with their respective polarity power leads directly at the barrel connector. Crimp or solder both power and sense lead directly into the mating barrel connector. Soldering is the the most foolproof method; however, soldering is not always necessary, especially where the sense leads are concerned. In any case, always try to connect the sense leads as close to the actual cell contacts as possible, and try to assure that current through the sense leads does not travel through any more connections than is necessary.

### **Making the Proper Connections when Charging or Discharging a LiPo Pack**

There are legitimate occasions when you may choose to forgo using a balancer during charging, for example, in order to charge at a higher rate.

In addition, you may be running a high current discharge on your LiPo pack. It is important to realize that improper use or connection of the sense leads during charge or discharge can result in damage to the pack or overcharge, leading to the unpleasant surprise of disqualification when the pack is inspected by technical personnel at a race. To avoid these unpleasant outcomes, you need to apply the principals outlined above.

Here is the best way to connect the sense leads when charging or discharging a LiPo pack configured with the separate balance connector.

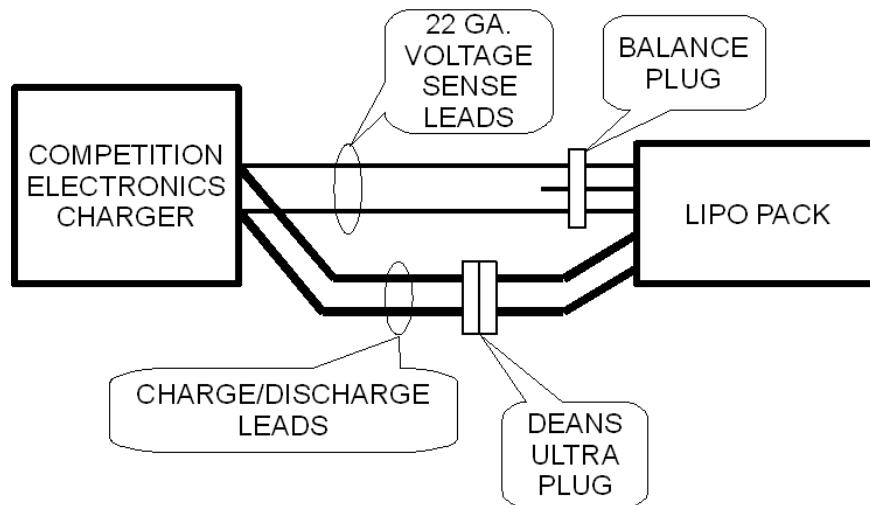

In this case, the sense leads are connected to the balance plug; you will want to connect them to the pins which correspond to the “outside” of the pack, that is, those pins across which the entire pack voltage appears. This gives the sense leads a direct and exclusive connection to the pack for the best voltage reading accuracy during charge and discharge. In almost every case this will be the two pins located at the outsides of the connector; you can check by measuring the voltage across the pins to see if it is the same as the voltage across the large current carrying leads.

Observe proper polarities.

In the case of a LiPo pack with bullet connectors, connect the sense leads directly at the main bullet connectors by stripping back a small bit of insulation at the bullet connector, then clipping the sense leads at these locations.

### **Important: Using an External Balancer with the T35-GFX LiPo**

The first thing to be aware of when using an external balancer with the T35-GFX LiPo is that it is to be connected only during charging. You must completely disconnect the balancer during discharge, cycle, or motor operations.

As already mentioned, the Turbo35-GFX LiPo incorporates special voltage sense leads so that it can measure voltage with greater precision under all conditions. However, this does make achieving the proper connections more complex, especially when charging LiPo packs using external balancing devices. Because accurate voltage control is a must when working with LiPo packs, proper connection of the sense leads is critical.

To reiterate: you must use the sense leads when working with LiPo packs!

In order to get good results when working with LiPo packs, it is important to understand these two principles:

- Connection of the sense leads should always be made as close as possible to the LiPo pack terminals, both electrically and physically.
- The more current there is flowing through a connection or wire, the more voltage drop will occur across that connection or wire, and the more error there will be in the voltage reading if that connection or wire is between the pack and the sense leads.

Now, with these two principles in mind, let's look at a couple of diagrams that show a hypothetical balancer used with the T35-GFX to charge-balance 2C LiPo packs.

The first, below, is a diagram showing the connections for a LiPo pack with bullet connectors. Note that this pack has two high current bullet connectors which serve for both balance and charge functions, and a separate, smaller bullet connector in the center which is intended for balancing. (That does not mean that it could not be used for charging, but current limitations of the smaller connector must be observed.)

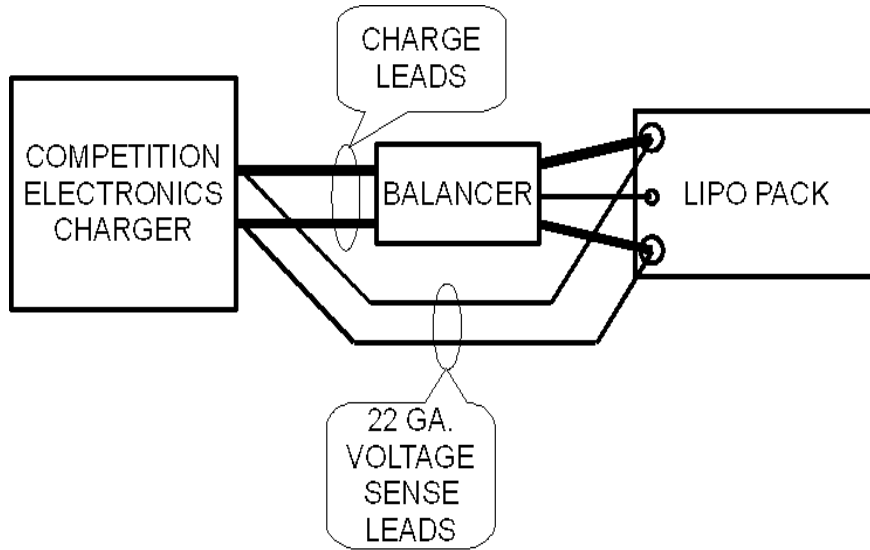

Note the following:

- The GFX's heavy current-carrying charge leads connect directly to the input of the balancer.
- The balancer's output leads, equipped with the proper harness, are connected to the LiPo pack per the balancer manufacturer's instructions.
- The GFX's sense leads are connected directly to the large bullet connectors on the LiPo pack.

A few things need to be said about this hookup:

- Do not charge at a higher rate than the balancer can endure.
- Observe all proper polarities.
- Observe the balancer manufacturer's directions.
- Make sure that the sense lead connections are made very close to the pack connectors.

In this case, we can be assured that under normal circumstances, the voltage drop across the bullet connectors will be very low, as they are high quality connectors designed for this purpose, so physically, the best you can do is to strip back the insulation right where the high current charge leads are soldered to the bullets and clip the sense leads at that point. There is a lot of current flowing through the power leads, but very little flowing through the sense leads, so in this case the only critical aspect of the connections of the sense leads is that they be made as close as possible to the bullet connectors.

Let's consider how to connect another popularly configured LiPo pack:

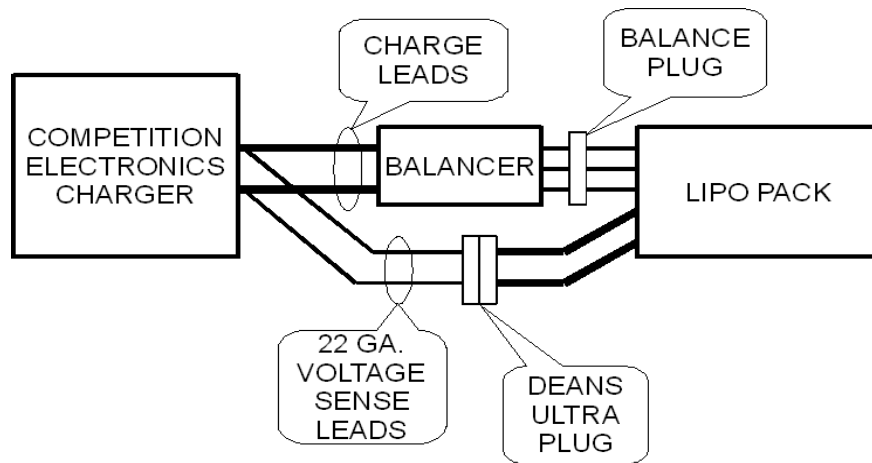

Here, the pack has a Dean's connector for the main power connections and a special pin and socket connector for the balance function.

The recommended connections for this pack are counterintuitive because in this case the charging occurs through the balance plug and the sense leads are connected to the Dean's plug. Inside a pack such as this, the balance and power connections go to exactly the same place, and as long as we don't exceed the current carrying capacity of the balance connector and its smaller wires, this arrangement will work very well.

In this case the high current (whatever the connector and balancer will allow, since the GFX's charge rate capacity will almost certainly exceed the balancer's capability) flows through the balance plug, and that leaves the Dean's connector free to be used as a sense connection.

You should be aware of the fact that any connector/connection can fail and cause inaccuracies or hazardous conditions to occur.

If proper principles are followed, special harnesses can be constructed to make implementing these connections easy and convenient. Contact Competition Electronics for details.

## Final Notes About Balancers

One should not assume that every balancer is compatible with the T35-GFX LiPo. Be alert for possible errors induced by the balancer. It is possible, though unlikely, that some balancers will not work correctly, or at all with the T35-GFX LiPo due to incompatibility issues.

## Balancing with the Turbo35-GFX Alone

You can balance a pack using only the Turbo35-GFX, as follows:

- Set up the GFX for a 1C charge.
- Charge each cell of the pack individually, using the proper combination of balance and main charge connections on the LiPo pack.

Just make sure that

- You do not exceed the current rating of the balance connector.
- You follow the principles outlined above when connecting the voltage sensing leads.

## How to Use this Manual

This manual is divided into several parts.

- **Quick Start:** If you can't wait to use your T35-GFX, go here. Come back later when you want to get into the details.
- **Learning about Cells, etc:** This section contains useful background information about cells and packs, and how to get the most out of them.
- **What can I do with my T35-GFX?:** Look in this section for more detailed operating instructions.
- **Specifications:** This section contains a concise technical summary of the T35-GFX capabilities and requirements data.
- **When it doesn't work:** In this section you learn how to tell if your T35-GFX is broken, and what to do about it. Also, look here for information about how to get your T35-GFX upgraded, calibrated, etc.

## Quick Start: A Starting Line View of the T35-GFX

This section of the manual will get you up and running fast.

### Prepping the T35-GFX for use

If your T35-GFX is new out of the box, you will need to configure the power and output lead wires. CEI supplies heavy duty alligator clips for these lead wires; they must be soldered to obtain a good connection. Alternately, you may choose to install some other type of connector, such as a Dean's® connector for the power connections.

When soldering, be sure to heat the conductors enough so that you get a nice shiny solder joint. Use enough solder to fully wet the conductors, but not so much that it forms a big ball, or glob. Use only rosin core solder, never acid core.

Good solder joints are shiny, not dull. Dull solder joints are usually referred to as "cold" solder joints. The usual cause is not heating the conductors to be soldered sufficiently before applying the solder. Lead-free solder may produce joints that are a bit duller looking.

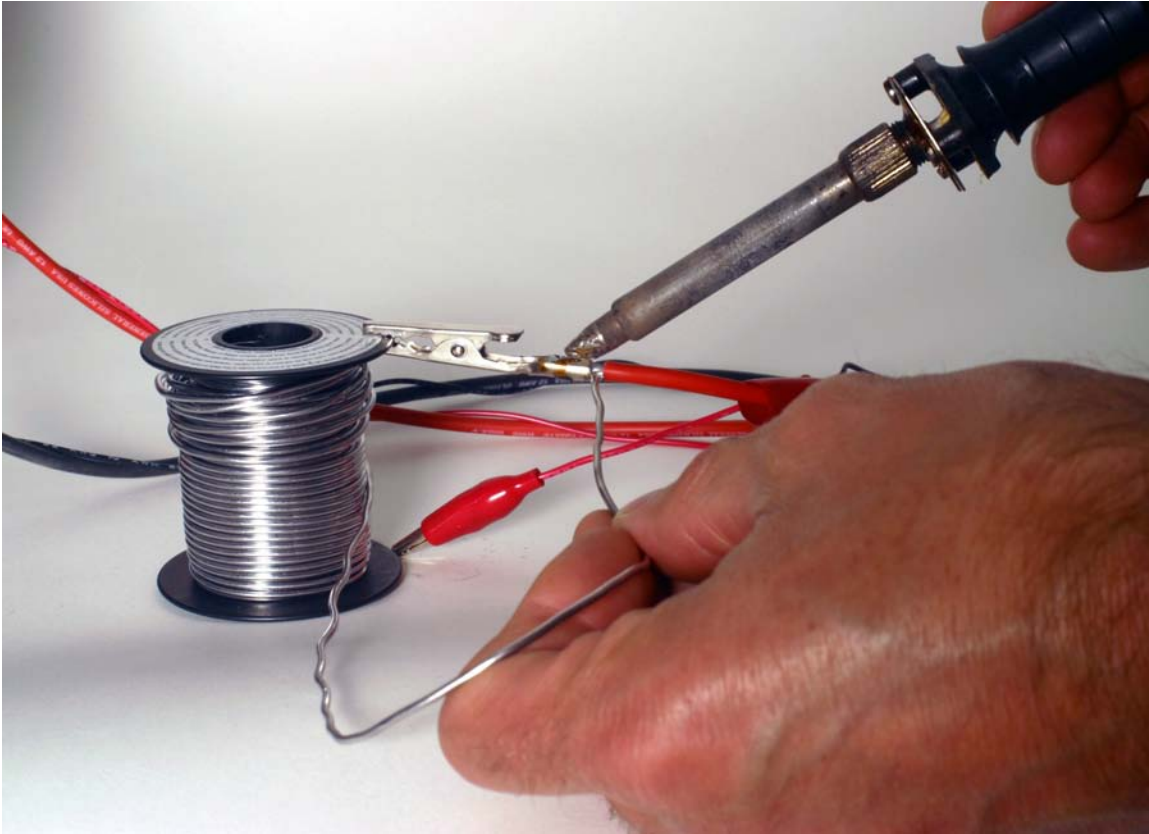

**Figure 1: Soldering an Alligator Clip**

Remember to put the alligator clip insulators on the wires before soldering the alligator clips, and make sure they're far enough away from the solder joint so that they don't overheat and melt.

If you plan to charge LiPo's, you will need to consider another connection system. See "Connecting the Turbo35-GFX Lipo to a LiPo Pack" further on in this document for advice here.

### **Powering up the T35-GFX**

The 14 gage 4 foot long pair of leads on the left side of the T35-GFX are to be connected to the DC power supply. The other leads are used to make connections to your pack or motor.

Avoid using the switch on an outlet strip or the line cord plug on the AC side of your power supply as a means control power to the T35-GFX. Instead, always make and break the final power connection to the T35-GFX AT THE DC INPUT WIRE on the power cable of the T35-GFX.

After terminating the lead wires, connect the T35-GFX power leads to a 12V-16V DC power supply.

Obviously, the red lead goes to the positive terminal; the black lead to the negative terminal of the supply. This DC supply should be capable of 20 amps if you want to utilize the full motor run capacity and 12 amps to realize the full charging capacity of the T35-GFX. See "Power Supply Requirements," below, for more details.

### **Getting Familiar with the T35-GFX Menu System**

Like many digital electronic devices, the T35-GFX has an LCD display that communicates the status of the T35-GFX to the user. By this means, the T35-GFX menu system is displayed. Below is a "menu tree" showing the navigation pattern for the T35-GFX menu.

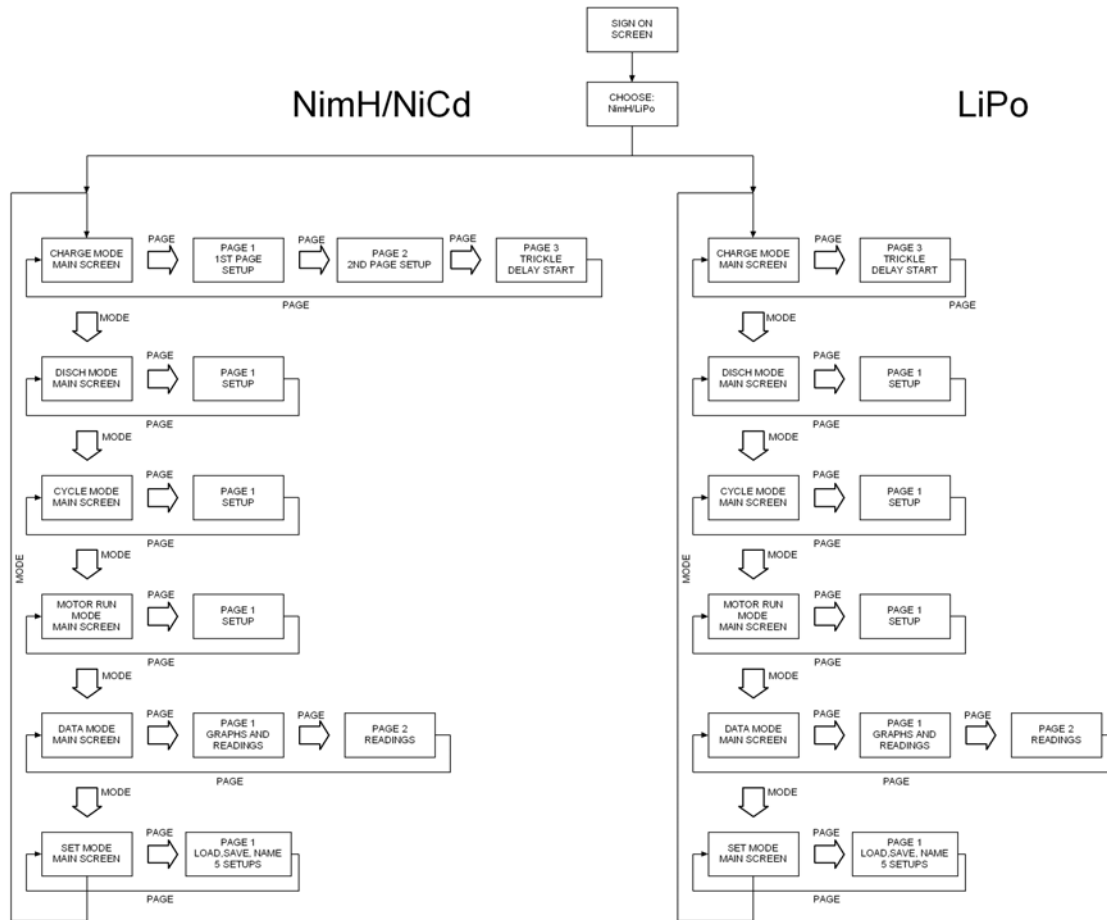

Figure 2: T35 GFX Menu Tree

When you first turn on the T35-GFX, the display will show the sign-on message, including the firmware revision number. This number corresponds to the version of software in the T35-GFX. From time to time, CEI upgrades this software, either to fix firmware “bugs” or to add new features. The firmware revision number may be important if your T35-GFX needs service; see “When it doesn’t work” for more details about this. After this, you will notice that the T35-GFX LiPo shows the Cell Type selection screen. Here, you can use the rotary encoder dial to select either NimH/NiCd or LiPo chemistry. The unit defaults to NimH/NiCd from the factory, but if you select LiPo and then run store the setup, the next time it will default to LiPo mode. A scrolling message will appear at the bottom of the screen indicating that the T35-GFX LiPo is in LiPo mode.

The T35-GFX has three buttons on the front panel, as well as a combination rotary dial/push button. The buttons are as follows:

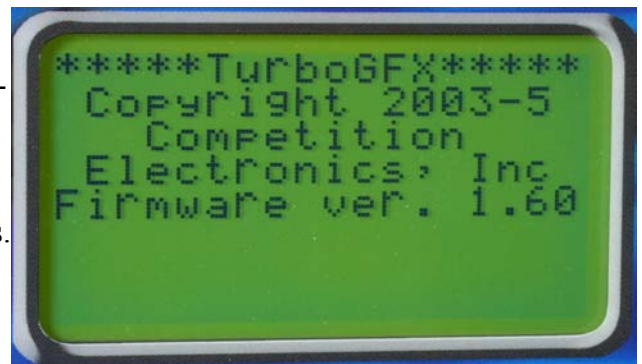

Figure 3: Sign-on Screen



**Figure 4: T35-GFX front panel controls/Selection Screen.**

**Start/Stop:** used to start and stop the selected function.

**Mode:** This button is used to cycle through the six main functions, detailed below.

**Page:** This button will cycle through the various screens associated with each function.

Use the Mode and Page buttons to navigate to the desired page, or screen containing the parameter(s) you want to view or change. In either case, when you get to the last Mode or Page, pushing the button again will go to the first Mode or Page of the series.

As you advance from page to page, individual lines appear on each page. Upon entry to a page, the top line will be highlighted, indicating it is the currently selected line.

To navigate to individual lines on a page, use the large rotary dial; just push it in to navigate to the next line on the display.

Some values are adjustable, and some are simply informational and cannot be changed. If you are on a line that can be adjusted, in general, rotating the dial CW or CCW will increase/decrease the value.

## The Mode Indicator Line

After you select NimH or LiPo mode, a scrolling message appears on the bottom line of the LCD screen to indicate what mode the GFX is in. The purpose of this is to further prevent trying to use the GFX in the wrong mode, such as trying to charge LiPo lacks when in NimH mode. It replaces the former help information shown on this line in earlier versions of the T35-GFX.

## Loading Factory Setups

A lot of users have questions about how to set up their T35-GFX for different types of packs and motors. In order to get you started, the T35-GFX comes from the factory with a number of standard setups already in the unit. The setups are good starting points for many common needs. This is the quickest way to get started.

Use the Mode button to navigate to the “set mode” display (shown in the upper right hand corner of the LCD display). The top line will be highlighted; by rotating the dial, you can select one of the presets and by pressing the “start” button, you can load it into the T35-GFX memory for use.

The factory settings are:

### NimH/NiCd

1. 6CellNimH: for a 6 cell, 3300mAHr pack.
2. 8CellTx: for a 8 cell transmitter pack
3. 4CellRx: for a 4 cell receiver pack
4. 4CellNimH: for a 4 cell 3300mAHr pack.
5. 6CellCyc: setup to run a charge/discharge cycle for a 6 cell 3300mAHr pack.

### LiPo

1. Li4800 2S: 4800mAHr 2 cell series pack.
2. Li3200 2S: 3200mAHr 2 cell series pack
3. Li800 2S: 800 mAHr 2 cell series pack



4. Li0500 2S: 500mAHr 2 cell series pack.
5. Li2200 3S: 2200mAHr 3 cell series pack.

Generic setups have been provided for both NimH/NiCd and LiPo packs as a starting point and a convenience to the user. It is the responsibility of the user to understand, select and adjust these setups to suit specific packs.

Load the factory preset cycle that most closely matches what you want to do. Then, if necessary, adjust individual settings to “tweak” the setting to your liking. If you don’t know much about how to set the various parameters, the preset cycles are a good starting point. As you learn more about the charging and discharging of cells, you can make adjustments as you wish.

If you are using the T35-GFX with something other than these more standard cell types, the charge and discharge rates will depend on the mAHr rating and the application the cells are being used in. Make sure to set properly if working with LiPo packs. Don't guess about current and cell count settings with LiPo packs.

### Connecting your pack and motor

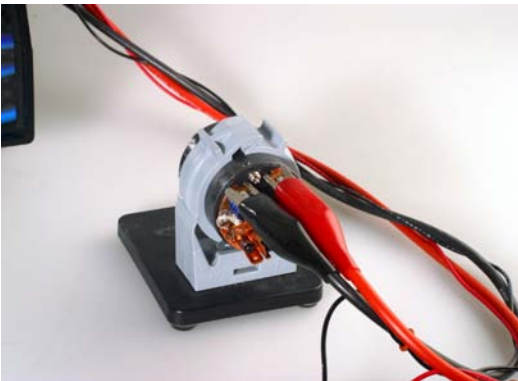

Figure 5: Motor Connections

First of all, you’ll notice that your T35-GFX has four leads. This is no accident. One of the things that set your T35-GFX apart from the competition is that it has a set of separate, smaller “sense leads”. Why? Ohm’s law tells us that where there is a higher current flowing, there will be a greater voltage drop across any resistance in the circuit under observation. In this case, most of the unwanted voltage drop occurs directly at the mechanical connections between the large, hi-current leads and the battery pack. This can be minimized by making better connections, but the fact is that there will always be a voltage drop at the connections, because of the high current flowing during charge or discharge. That is why we have the additional small sense leads. These leads are designed specifically for

measuring, and will have essentially no voltage drop at all, because the current flowing through these leads is relatively low. The advantage of this is that they can measure the voltage far more accurately. So in general, it’s best to always use the sense leads. Note: You must never fail to use the sense leads for any LiPo cycle. In the case of NimH/NiCd operations only, you may choose not to use them during charging, The readings will be slightly off, but it will not affect the amount of charge delivered to the pack.

Sense leads should be connected as near as possible to the pack/motor terminals. If possible, they should make their own connection directly at the device terminals. In the case of LiPo packs, where the terminals are not physically exposed, connect the sense leads directly to the main pack terminals at the barrel connector and solder.

### Quick Start: Nixx or LiPo Select

It is always necessary to select the chemistry at startup. This is a safety feature to help you from making costly and dangerous mistakes. Select the chemistry type with the rotary dial, then press START.



Figure 6: Typical Nixx Sense and Power Lead Connections

### **Quick Start: Charge**

1. Load a setup from the T35-GFX memory, or use the currently loaded setup, if appropriate.
2. Navigate to the “chg mode” screen.
3. Make any adjustments that might differ from the stock factory setup.
4. Connect Power and Sense leads to the pack.
5. Press “Start”.

### **Quick Start: Discharge**

1. Load a setup from the T35-GFX memory, or use the currently loaded setup, if appropriate.
2. Navigate to the “dcg mode” screen.
3. Make any adjustments that might differ from the stock factory setup.
4. Connect Power and Sense leads to the pack.
5. Press “Start”.

### **Quick Start: Cycle**

1. Load a setup from the T35-GFX memory, or use the currently loaded setup, if appropriate.
2. Navigate to the “cyc mode” screen.
3. Make any adjustments that might differ from the stock factory setup.
4. Connect Power and Sense leads to the pack.
5. Press “Start”.

### **Quick Start: Motor Run**

1. Navigate to the “mot mode” screen. There are no specific factory cycles for motor run, although values are saved and included in all setups.
2. Using the “Page” button, go to the “1 of 1” motor parameter screen and select the motor voltage and run time.
3. Connect Power and Sense leads to the motor.
4. Press “Start”.

After you get up and running, be sure to read the rest of the manual. Do it while you're charging those high capacity packs; you'll be glad you did.

## **Learning about Cells and Packs for R/C Racing**

One of the hurdles for beginning R/C racers is gaining a basic understanding of these power sources we call cells. It turns out that the cells we use, and how we treat them has a huge effect on racing performance. The objective of this section is to give you that basic understanding.

The technology that makes R/C racing possible is the advent of rechargeable cell types that are capable of sustained high rates of discharge. It is probable that R/C racing as we know it could not exist if this technology had not been discovered.

### **Types of Cells Used in R/C Racing**

There are two main types of cells used in R/C racing today, as well as the promise of a third, LiPo.

NiCd: NiCd stands for Nickel-Cadmium. Until the last few years, NiCd was the most popular cell used for R/C racing.

NiCd cells have a typical cell voltage of 1.2 volts. Among their disadvantages is the fact that they have a “memory” and if they are not routinely discharged completely and recharged fully, their capacity diminishes considerably.

Another disadvantage of NiCd chemistry is that they require special disposal procedures because of their cadmium content.

They are a bit more durable than NimH cells and can stand a bit more abuse, but their mAHr capacity is considerably lower than NimH types. They are more consistent in their charge/discharge characteristics from cycle to cycle.

NimH: NimH stands for Nickel-metal-Hydride. NimH is still the predominant cell in use today for R/C racing. NimH chemistry does not suffer from any of the disadvantages of NiCd. It is less toxic, does not have a memory, and now comes in higher mAHr capacity than the NiCd types.

Today’s NimH cell voltage after “zapping” (we will discuss zapping a little later) have significantly higher average voltages.

NimH cells should still be recycled at the end of their useful life.

LiPo: Lithium polymer chemistry is currently making the move from cell phones and laptops into R/C car racing.

The LiPo packs offer the advantages of lighter weight, greater capacity, and greater longevity. Currently LiPo packs, however, cannot deliver as much power as a good quality NimH pack in good condition, but that will likely not be true for much longer. That is why LiPo capability has been added to the T35-GFX.

The biggest disadvantage of the LiPo chemistry is the possibility of it's catching fire or exploding due to physical damage or electrical abuse. For this reason, the charging and discharging procedure for LiPo packs is much more stringent and must be strictly observed. Dispose of LiPo packs properly.

### ***RC Racing is different from other battery applications***

If you talk to a cell manufacturer about the way R/C racers charge and discharge their NimH/NiCd cells, he or she may tell you that you are abusing these cells. The fact is, to a certain extent, this is true. However, the goals of an R/C racer are different than the goals of an average user. In the case of the R/C racer, there is the need to balance cell longevity with performance. It is an inherent trade off racers make, so you should understand from the beginning that racers don’t treat their cells “nice”. As a result, they cannot be expected to last as long as they might in a less demanding application. If you are interested in ultimate performance, plan to relegate older packs to practice duty after they have been used for a while. Exactly when you do this is a function of your skill level and how much you are willing to spend on cells.

LiPo packs are different. They **MUST** be charged and discharged according to the manufacturer's specifications. There is no room for mistakes here; follow the manufacturer's specifications exactly when working with LiPo packs!

### ***How can Cell and Pack Capacity be Measured and Compared?***

Pack performance is one of the crucial make-or-break factors in R/C racing. The best drivers can use every extra bit of voltage and current available from the best packs. Because NimH and NiCd cells can vary considerably from cell to cell, and because their performance can degrade or change depending on how we treat them, how old they are, etc, we need a way to measure and compare our cells in order to identify the best cells, as well as the best procedures for charging, discharging, and using them. The T35-GFX is designed to do just that.

## Setting up Tests and Comparing Data

The best way to test and measure cell performance is to set up defined conditions for charge and discharge, and then run these tests on cells to see which cells are the best.

When you do this, it is also important to be aware that the very conditions under which they are charged and discharged have a direct effect on their performance.

Basically, the idea is to run these tests on cells, looking for the ones that have the highest average discharge voltage, the lowest internal resistance, and the longest run time.

In general, when charging NimH/NiCd cells and packs, you'll want to strike a balance between a high charge rate (which minimizes charge time) while keeping cell heating within bounds.

The rule of thumb for charging LiPo packs is to charge at a 1C rate (more on this later.) That is why the GFX LiPo charge rate is set in mAhrs; because it allows direct input of the 1C mAhr rating inscribed on the LiPo pack. Some manufacturers allow higher charge rates; this will be determined on a case by case basis.

When discharging NimH/NiCd cells and packs, you'll want to try to use the highest discharge rates applicable to the cell type you are using, in order to test it under conditions similar to actual use.

When discharging (and charging, and storing) LiPo packs, you need to consider the maximum temperature of the pack. Do not allow the pack to exceed manufacturer's specifications. The T35-GFX can sustain a 35 amp discharge rate, which will easily overheat some LiPo packs, so be alert.

Racers often ask what will be the effect of increasing the charge current, lowering the peak detect voltage, etc. The T35-GFX is the perfect tool for getting answers to all these questions! Which manufacturer's cells perform better? What rate should we charge at? All these things can be tested and answered by the racer using the T35-GFX.

You can use it to test single cells or packs.

## Balancing

Both LiPo and NimH/NiCd packs can become unbalanced after some period of usage. Unbalanced packs are packs made up of cells that are in a different state of charge capacity, and so when discharging or charging, some cells in the pack will reach the end of the process before others.

With NiCd/NimH packs, this is not so critical, but with LiPo packs, it can be a big problem, depending on the amount of imbalance present. That is why LiPo manufacturers almost always provide balancing contacts on LiPo packs. Balancing contacts are nothing more than electrical connections at the electrical junctions between individual cells.

To insure proper maintenance and long life of LiPo packs, the charge state of each cell in a LiPo pack should be periodically balanced by setting up the GFX for a single cell pack (1S) and running a charge cycle on each individual cell in the pack. This will bring each cell in the pack to a full charge state independently and 'balance' the pack.

It might be possible for cells in a LiPo pack to deteriorate so much that cell to cell characteristics will be too different to allow for charge/discharge of the cells as a complete pack. Another possibility is that one cell in a pack might go bad. For this reason, it is imperative that you observe all charge/discharge operations with LiPo packs and that you do not leave LiPo cycles on the GFX to run unattended.

NimH/NiCd packs can also become unbalanced and may be rebalanced in the same way.

## Single Cell Testing



Figure 7: T35-GFX and Single Cell Holder

If you're planning on doing a lot of single cell NiMH/NiCd testing, you will want to get a cell holder from CEI, #CEI-4903. See our website for this and other products.

To use the optional battery box, connect the large alligator clips to the bare 14 gauge wires on the battery box, (red to red and black to black) or install a high quality connector of choice. Whatever connector you choose should be rated for continuous current capacity of 35 amps if you intend to discharge at full rated capability. Then, connect the small red alligator clip to the small red lead on the cell holder, in like manner, connect the small black alligator clip to the small black lead. The small voltage leads must be connected to get accurate discharge readings. DO NOT increase the length of the battery box high current leads, or introduce any type of additional connection other than the main connection formed with the end of the leads. To do so may cause discharge current to taper off at the end of the discharge, due to additional voltage drops introduced by the additional series resistance.

Mount the the battery box to a flat surface with the holes provided.

The cell in the battery box may be loaded and unloaded by means of the convenient operator lever. The positive terminal of the cell goes to the red lead end of the box.

The plating used in the contacts is relatively maintenance free and needs no cleaner as a general rule; you may need to use a light gage wire brush on them occasionally.

### To Recap...

So, start with the appropriate factory preset. Talk to other racers. Do your research on the Internet. Then, take an old pack and start to modify the settings, and keep track of the changes in a notebook. Log the charge settings

and the results when you discharge. And don't forget to try it in your car! That's where "the rubber meets the road," so to speak. Look for a change in your personal performance. Over time, you'll find what works for you.

## **Useful Parameters for Measuring Performance**

The T35-GFX can make a number of useful measurements that will help you to evaluate your cells. Here are some of the most useful.

### **Actual Internal Resistance**

The actual internal resistance measurement made by the T35-GFX conforms closely (not exactly) to the ANSI standard C18.2M-1997 for sealed rechargeable batteries. It is a measure of the internal resistance of the pack or cells and will correspond to the packs ability to deliver power. It is presented in units of milliohms (1/1000 of an ohm) and it is measured during the discharge cycle. A lower number is better. There is no hard and fast rule concerning at what rate to discharge cells when making this measurement, but in general, to get the best comparison data, it's a good idea to discharge packs at the same current rate.

It is good to keep in mind that this measurement will include resistance in the connections between cells, etc. Make sure that you test packs and cells under similar conditions. For example, use the same method of connecting to cells for all the packs or cells you want to compare.

### **Peak Charge Volts**

In a general way, a higher peak charge voltage means that it took more volts across the pack to induce the setpoint current through the pack during charge, for a given charge rate. This is an indication of the pack's internal resistance and age; higher voltage means the pack is less desirable. This parameter does not apply to LiPo packs, since they are always charged to 4.22V/Cell. Firmware revisions before 3.00 cross over at 4.2V. A firmware upgrade is available.

### **Discharge Average Volts**

Discharge average volts is simply that, the average voltage over the discharge curve, measured at intervals, from the start of the discharge cycle until cutoff. Of course, a higher number is better because it means that the cells will deliver a higher average voltage to the motor. More volts means more power.

### **Discharge Average Volts at 1V**

This parameter is useful in this way; that most people won't care about the average voltage after the per-cell voltage drops below 1 volt, because the cells are too discharged to provide useful power. It will result in a higher number than Discharge Average Volts and represents the voltage over a more useful range. This parameter does not apply to LiPo packs.

### **Run Time**

How long from the start of discharge until cutoff at the set discharge current? Longer is better, if you need the time. If your races are short, that means that the pack could have delivered more power if it was required. Maybe changing to a higher current motor, or changing the gearing might give you more performance by allowing you to utilize more of your pack's stored power.

## mAHr

mAHr (milliampere-Hours) is the capacity of a cell or cells expressed as the product of the discharge current in milliamperes times the time it delivers this output current in hours. (a mA is 1/1000 of an ampere.) Manufacturer's mAHr rating on the types of cells R/C racers use is typically printed right on the cell jacket. mAHrs can flow into or out of the cell; in other words, we can use mAHr to describe the rate of charging or discharging. Due to the built-in inefficiency of power transfer into and out of the cell, it will always take more power to charge up a cell or pack than the cell or pack can deliver into a load.

You can use this to figure out how long a pack can supply a given current before it is spent.



Figure 8: Close up of 3300 mAHr cells

## mWHR

mWHR (milliWatt-Hours) is a measure of the power the cell can deliver over time. It is measured and calculated in the T35-GFX by making a measurement of the output voltage for a periodic mAHr rate, and multiplying the voltage measurement times the mAHr for that time period, and totaling the result for the duration of the discharge period until cutoff.

## Relative Internal Resistance

Relative internal resistance was developed by Jeff Pack (a programmer and racer) as a way of making cell comparisons related to the internal resistance of a cell. You can use it to compare packs; a lower number is better.

In order to measure this parameter, a full charge/discharge, also known as a Cycle, must be run. In order to get comparative numbers, you must use similar settings for charge and discharge current across packs to be compared.

It has been largely replaced by Actual Internal Resistance, another CEI innovation in R/C racing competition-grade equipment.

RIR does not apply to LiPo packs.

## *Maximizing Performance: What helps, what doesn't*

### Understanding Cell Rating and Manufacturer's Specifications

If you buy your cells from a distributor or matcher, you may not have thought about the fact that they are a middle man to the manufacturer. Google for the manufacturer's website; you may find valuable information concerning the cells you are using.

### Charge and Discharge Rates and the "C" Rating

For instance, manufacturers of storage cells rate their cells by giving them a "C" rating. Below is a graph of cell voltage vs. percentage of full capacity charge input for a 1C charge rate for a 3300 mAHr sub-c NimH cell. This is related to the rate of discharge current which will empty the cell of charge in 1 hour. **So, a "1C" charge rate is the approximate current necessary to charge a dead cell to full capacity in 1 hour.**



(Note: Due to inherent inefficiencies in charge transfer into the cell, the actual charge mAHr will always be more than the rated mAHr in order to achieve full charge capacity.)

## How to determine Starting Points for Charge Rates, Discharge Rates, and Peak Detect Settings for Nimh/NiCd Cells and Packs

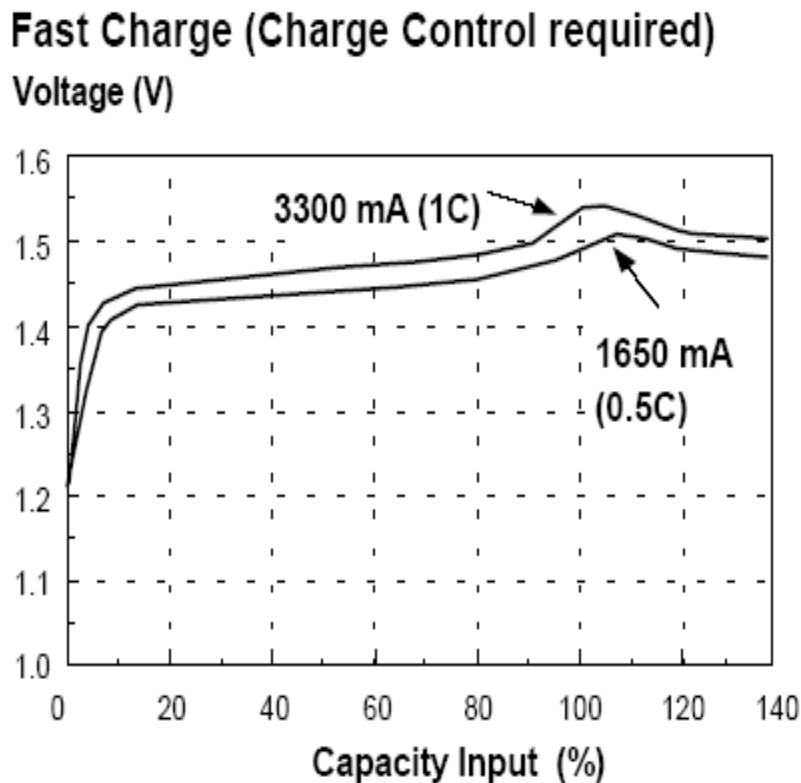

Figure 9: 1C charge profile for 3300 mAhr NimH Cell

### Charging

So, at what current should packs be charged? For more normal applications (not R/C racing!), the manufacturer might recommend a 1C charge rate, which should result in a life expectancy of >500 charge/discharge cycles, according to the data sheet.

For smaller capacity cells, it's probably a good idea to stick to 1C charge rates, but as the cell capacity gets larger, the cell can handle higher rates.

For another, there is some evidence to indicate that a higher charge rate will result in better performance on the track. Racers routinely charge these cells at 5A (5000mA) and better. One racer likes to charge his high capacity NimH cells at 10A (better than a 3C charge rate) because he claims that it improves the performance!

### Peak Detect

Notice the little voltage "hump" at the 1C point in the graph above, followed by the drop in voltage. This is called "peaking" and this is the method used by many chargers, including the T35-GFX, to determine when the charge is finished. When you set the peak detect voltage in the T35-GFX, you are telling the T35-GFX to terminate the charge when the voltage drops back from the peak, or maximum voltage seen during the charge



process, by the peak detect amount. If you use the T35-GFX graphing feature to look at the charge curve, you will be able to see this hump for yourself.

The actual peak rate of change and the magnitude of peak negative dropback voltage are highly dependent on the charge current. At charge rates of, say, 0.5C and below, the peak negative dropback voltage may be too small to serve as a reliable indicator of charge completion.

A typical value for peak detect for a NimH pack is 0.007 to 0.010 V/cell, or 0.04 to 0.06 volts for a 6 cell pack. The value for a NiCd cell will be somewhat higher, typically 0.008 to 0.013 V/cell, as the NiCd cell exhibits a larger peak negative dropback voltage than a NimH. CEI recommends using the lowest value required to reach a temp of 130° to 140° F.

### ***False Peaking***

As you can see from the graph, the voltage at the start of the charge cycle will jump up some amount as current is applied. Then, the voltage will “level out” for a while, or slowly rise. It is at this point that NimH (and NiCd) packs often exhibit a characteristic called “false peaking”. The pack voltage will actually drop, even though the pack is not yet near full charge. This effect can be magnified if “dead shorting” or deep discharging the battery. If you are not aware of this, you may think your packs are fully charged, but in reality, they are only partially charged. If your pack appears to have peaked too soon, a quick test is to feel the pack to see if it is warm. If it is not good and warm, that means that the pack false-peaked and is not fully charged. If the T35-GFX indicates something less than the 1C mAhr rating has been delivered to the pack, it is almost a certainty that the pack has false peaked.

False peaking can be overcome in the T35-GFX by using the “Long Lockout” feature to cause the T35-GFX to ignore voltage drop across the pack at the beginning of the charge cycle. It will automatically re-enable its peak detect monitoring after the time for false peak rejection has expired. This has proven to be quite reliable as a method to avoid false peaking. It eliminates the hassle of having to restart the charge cycle because the pack false peaked.

LiPo packs do not “peak” as such and no peak detect function is supplied in the LiPo charge cycle.

### ***Cell Heating***

When charging properly functioning NimH packs, during the first part of the charge process the cells will self heat slightly. NiCd cells do not exhibit this self-heating behavior before peaking. For both types of cells, temperature will rapidly rise as the pack nears full charge. Normally, for good cell longevity, it is desirable to minimize cell heating as much as possible. However, in R/C racing, there are definite advantages to heating your cells! It turns out that the performance of warm cells is noticeably superior to cold cells. It will then be better to peak your cells right before a race, so that they are warm when you use them. Also, some racers thermally insulate the pack while charging, to cause the pack to build more heat during the charge process, while maintaining a lower peak detect voltage.

Another factor that will heat the pack is a higher charge rate. A higher peak detect voltage will also result in a hotter pack. But don’t forget that excess heat does damage the cells and will shorten their life. Normal treatment of NimH cells would dictate as small a peak detect voltage as possible, to avoid as much heat as possible during charging, but R/C racing is different!

LiPo cells do not heat during charge under normal charge rates. It is indeterminate what effect moderate heat has on a LiPo pack at this time.

### ***Cell “Venting”***

Both NimH and NiCd cells have vents at the positive electrode end that will release pressure (and electrolyte) when the cells are charged. This venting is normally to be avoided. It will occur at higher charge rates. Repeated venting will certainly degrade cells.

LiPo cells are hermetically sealed and do not vent under normal conditions. If this seal fails fire will be the likely result, so don't allow your LiPo cells to be punctured.

### ***TurboFlex: What is it and what does it do?***

Your T35-GFX includes a feature called “TurboFlex”, also known as “burping”. TurboFlex is only intended for use with NiCd cells. The rationale behind TurboFlex is this: Charging NiCd cells can cause crystalline deposits to build up inside them, resulting in performance degradation. Periodic discharge pulses delivered during a charge cycle can reduce these deposits, thus improving performance. Using the TurboFlex feature is not beneficial when actually charging for use in a car, but rather should be regarded as a conditioning procedure. Do not use TurboFlex when charging your cells for racing.

The T35-GFX is set up for variable adjustment of the TurboFlex feature. The settings go from 1 to 9, with 1 resulting in the lowest ratio of discharge to charge time, and 9 the highest. In the case of the T35-GFX, the TurboFlex discharge rate is fixed at 5 amps.

TurboFlex will not take place, regardless of the setting, if the charge current is  $\leq 3A$ . This is built into the T35-GFX.

### **Discharging**

The T35-GFX includes a discharging function that can discharge at rates of up to 35 amps. With this feature, you can test your cells and packs and measure their performance. You can tell when the performance is falling off, and you can extend the performance of your packs by re-matching cells and combining similar cells into packs.

### ***Discharge Rate and It's Relationship to Performance***

Over the years, CEI has repeatedly increased the discharge rate of our charger/dischargers. This is because our customers demanded the higher rates. One reason for this is the fact that cell capacities have increased. Another reason is that R/C motors these days draw a lot of current, so it takes a higher discharge rate to emulate these high currents.

The discharge function is the main tool that you use to compare cell performance. You can discharge a cell or a pack to a defined cutoff voltage at a fixed current and observe the discharge voltage over time as a graph, as well as time the discharge duration. Obviously, a rather simple application of this, and one that is used most frequently, is to run the identical discharge procedure on several similar packs and compare the results. More run time is better, of course, but a higher output voltage is better, as well. Again, when charging or discharging LiPo packs, be sure to keep the rates low enough that maximum temps are not exceeded. Refer to manufacturer's specifications for these temperatures.

### ***Nimh/NiCd Cell Matching and it's Effects***

For the best performance, you'll want to obtain what is known as a matched pack. This means that the cells in the pack have similar discharge profiles. This is desirable because cells with similar discharge times and similar discharge profiles will tend to deliver similar output power over the same time period. They will reach the end of their power output at the same time. Matching prevents the condition where some cells in a pack are still delivering current to the load while others are fully discharged.

At the time of this writing, LiPo manufacturers are providing balanced packs as a matter of course.

## Charging LiPo Packs

LiPo charging is a two stage process. The GFX will supply constant current at the mAhr rate selected by the user until the pack reaches a voltage of 4.22V/cell. It then switches to a constant voltage of 4.22V/cell and monitors the current until it reaches approximately 3% of the mAhr charge rate setting. At this point the charge cycle is terminated. This basic process cannot be altered by the user. Firmware revisions before 3.00 cross over at 4.2V. A firmware upgrade is available.



Figure 10: a LiPo Pack connected to the T35

## Discharging LiPo Packs

Discharge of a LiPo pack occurs at the user-selected discharge ampere rate setpoint until the pack reaches a termination voltage of 3V/cell, at which time the discharge is terminated. This basic process cannot be altered by the user.

As we have already stated, individual cells vary widely, both in output voltage and discharge, or run time. Cell matching companies go through many cases of batteries in order to separate out the best ones, and match them into packs for top racers. The lesser quality cells are also matched into packs, but they are sold for less money. Most matcher companies use the older CEI TurboMatcher 4 or the CEI TurboMatcher 8 (a special charger/discharger that is designed to grade 8 single cells at a time) to test cells and match them. At this point, no matcher exists in the CEI product line for LiPo cells.

You can do the same thing with a T35-GFX; the only difference is that you will have to do one cell at a time.

Another reason for matching cells is that over the course of multiple charge/discharge cycles, the state of charge of the individual cells within the pack becomes imbalanced. Matching is a way to restore and recharacterize (test 'em again) each cell and even to gain information that will allow you to recombine these cells into new, different combinations when their characteristics change; to “rematch” them.

The primary number for matching cells is the discharge time. The object is to gather up sets of cells with as close a discharge time as possible.

In stock class, the discharge average voltage is also an important number. You want as high a discharge average voltage as you can get. When grading for stock class, use the discharge time first as the primary parameter; then use the discharge average voltage as a secondary parameter. The higher the discharge average voltage, the more “punch” the motor will have. This is because the pack with a high discharge average voltage is delivering a higher voltage to the motor for a given period of time.

Another factor that affects “punch” is actual internal resistance. A lower actual internal resistance is always better. The more you can maximize these parameters, the better the motor performance will be.

When using packs with modified motors, the actual internal resistance should become the second parameter to grade by. The discharge average voltage is not as important because you can always go to a lower wind (read: lower impedance) motor to compensate for the lower voltage.

Remember that when you are testing new packs, always cycle the packs 3 or 4 times at the beginning, so that you achieve maximum performance from each cell. New cells need a few cycles to properly break them in. This is true as well if they have been sitting on the shelf for any period of time longer than a couple of days.



Figure 11: TurboMatcher 8

In order to achieve the best performance from your packs, you will need to determine the correct peak detection voltage to use when charging them. Given a sufficient charge rate, monitoring the cell temperature is an excellent way to do this. A typical peaking temperature is around 125° F. The temperature rise is an indication that the chemical reaction that takes place within the cells at the end of the charge cycle has come to completion. For packs, start with a low peak-detect voltage such as 0.03 volts. Monitor the pack temperature and increase as needed until the final temperature hits the target. Be aware that different model cells, and different manufacturer’s cells may differ in the peak detect voltage required to achieve the desired temperature.

### Using Simulated Discharge Profiles to Condition NimH/NiCd Packs

There is some evidence to indicate that NimH/NiCd packs respond to the way you drive them. Consider the difference between an oval racer and the off road racer. The oval racer settles into a pattern: Jam down the trigger going out of the turn, let off going into the next turn, then do it again. The off road racer has an entirely different pattern.

For this reason, the T35-GFX includes conditioning discharge cycles for oval and off road racing. These discharge cycles periodically increase and decrease discharge current to simulate oval and off road racing patterns.

They are intended for conditioning only, and the display of regularly measured and calculated parameters are not supported in these modes. So don't be surprised when the measured data don't look right after using one of these discharge modes.

The T35-GFX programming locks out simulated discharge conditioning profiles below a discharge current setpoint of 3 amps. This is built into the T35-GFX to avoid drawing large currents from small capacity cells. You should not try to run these profiles on cells smaller than, say, 2000 mAHr rating, as it will attempt to draw 45 amps from the cells at times during the profile execution.

### **Zapping: What is it and what does it do?**

“Zapping” is a process where special equipment is used to discharge a high voltage pulse through a NimH/NiCd cell. Each battery matcher will have their own way of doing this, and will not likely reveal the details of their process. However, zapping does increase voltage output of the cells, and it is an important component for maximum pack performance.

NOTE: CEI does not make battery zappers, and we want to advise you that they generate hazardous voltages. CEI makes no recommendations concerning the use of cell zappers. Do not, under any circumstances, attempt to zap a LiPo cell or pack.

### **Extreme NimH/NiCd Discharge/Equalizing**

Another technique that some racers are using, especially oval racers, is the technique of extreme discharge. Using an equalizing battery tray, they discharge their cells down to 0V by leaving them in the tray for 15 minutes to several days. Some racers then follow this by dead shorting the pack with a wire and storing their packs this way.

Allegedly, this results in shorter run times, but higher average voltage for the duration of the run time.

Another effect claimed is that the mAHr input that the pack will receive is increased if the pack undergoes extreme discharge.

Finally, it is said that using an equalizing tray will help overcome the scatter effect. Especially with NimH cells, after a few charge discharge cycles, the position of the individual cells in their discharge curves tend to “scatter” with relationship to one another and become desynchronized. Equalizing tends to re-synchronize the cells, by entirely draining their charge.

In general, one may notice that longer periods of extreme discharge result in higher voltages but shorter run times. Your results may vary.

Extreme discharge may also result in increased false peaking.

All we can say is that if you're an avid stock racer, you will want to experiment with extreme discharge.

### **Getting the Most out of your Cells Depends on Driving Skill**

Here's an undeniable fact: all the voltage and current in the world won't help you if you don't have good driving skills. Only good drivers can utilize the small but real advantage that the best packs give. If you fit into this category, you need 'em. If you're not quite there yet, maybe you can get away with cheaper packs. You'll have to be the judge, here.

## **LiPo Cautions:**

Experimentation with LiPo packs is much more limited. Be sure to read the cautions at the beginning of this document. Voltage, current and temperature must be applied to LiPo cells and packs in very limited and specific ways. Make sure your tests with LiPo cells and packs are conducted within safe operating limits.

## **Hmmm: It sounds Cool, but is it Useful? Gimmicks, Trends and Superstition**

Finally, keep in mind that this is applied science and like any field of knowledge, there's such a thing as smoke, mirrors, and snake oil. If somebody tells you that submerging your packs in milk for a couple hours will give you better run times, don't believe it. (Unless you happen to try it and it works!) Look out for manufacturers advertisements that contain long lists of acronyms that you never heard of before, and that sound nonsensical. If they seem bogus, they probably are. Remember, you're a marketing target!

Sometimes, racers get in line like lemmings to chase after the latest gimmick. We find that these gimmicks peter out after a little while, as racers discover that they don't do anything (useful, that is...). If you hear about some new technique, feature or device and you want to know if it works, use the T35-GFX to check it out. Then, instead of guessing, you'll KNOW.

## ***Final Advice (for now...)***

There's no way we at CEI could carry out all the research needed to find out the best ways to charge, discharge, and condition cells to get the very best performance out of them. The next best way is to give racers a tool to do it themselves, and then turn 'em loose with it. The T35-GFX is such a tool.

Technology keeps changing. Capacities increase, cells get more durable and more powerful. Keep an open mind. Talk to other racers. Use the Internet. This way, you'll find out what works best for you.

## ***Resources on the Web***

The following links are a compilation from various members of the CEI staff.

Batteries in a Portable World: "A handbook on rechargeable batteries for non-engineers"

<http://www.buchmann.ca/>

GP Batteries Corporate Website: Contains datasheets for some popular R/C cells.

<http://www.gpbatteries.com.sg/>

Sanyo US: More datasheets here.

<http://www.sanyo.com/home.cfm>

Intellect Batteries: More battery info here.

<http://intellect-battery.com/>

Kokum LiPo Batteries: LiPo applications info and datasheets.

<http://www.panasonic.com/industrial/battery/>

## **The T35-GFX in Detail**

This section of the manual is the place to go to get detailed information on how the T35-GFX works and how to use it. See the previous section for detailed information about what each setting does.

## What can I do with my T35-GFX?

The T35-GFX functionality is presented to the user as a set of 6 menu functions, referred to as MODES. When the T35-GFX is first turned on, it goes through the sign-on screen, where you see the copyright notice and the firmware revision number. Next, it prompts you to select battery type: either NiMH/NiCd or LiPo. After that, the Charge menu for the selected battery chemistry appears. Moving through the various screens of the menu tree is called navigating the menu tree.

Note the three buttons clustered to the left of the rotary dial/switch on the right hand side.



Figure 12: T35-GFX Front Panel Controls

They are:

- START/STOP
- MODE
- PAGE

### **The MODE Button**

The T35-GFX display can be advanced from one mode screen to the next by pressing the MODE button. It will move through these modes:

- CHARGE
- DISCHARGE
- CYCLE
- MOTOR
- DATA
- SETUP



Regardless of which chemistry you have selected, you can always tell what MODE you are in by observing the MODE STATUS display in the upper-right-hand corner of the display. They are:

- chg mode
- dcg mode
- cyc mode
- mot mode
- dat mode
- set mode



**Figure 13: Typical status screen showing the mode display in the upper right hand corner**

Regardless of what PAGE you are on in a given MODE, pressing the MODE button will always advance the display to the main screen of the next mode. There is one exception: when CHARGE, DISCHARGE and CYCLE modes are active, the MODE button toggles back and forth between the main MENU screen and the real-time GRAPH screen. Using this feature, you can see the charge or discharge curve as it is being generated.

### **The PAGE Button**

In any given MODE, one or more SETUP screens are available. You can sequentially cycle through these SETUP screens by pressing the PAGE button.

The SETUP screens contain adjustable and measured data parameters specific to the mode selected. For CHARGE, DISCHARGE and CYCLE modes, there are essentially no settable parameters on the main screen (except for a few exceptions, which we will discuss later.) In general, parameters for these modes must be adjusted from the SETUP screens.

For the DATA and SETUP modes, some values can be set from the main mode screen, as well as from the selected mode's associated SETUP screens.

So, you can think of this by envisioning in your mind a picture of a vertical list of screens, which represent the different MODES. When you come to the last MODE screen in the vertical list, pressing MODE once again will bring you back to the first MODE screen, which is the charge screen.

For each MODE, you can envision a horizontal list of screens which represent the various SETUP screens associated with that mode. Like the MODES, when you come to the last SETUP screen for the selected MODE, pressing PAGE once more returns you to the main MODE screen for the selected MODE.

You can tell what PAGE you are on for the selected MODE by observing the PAGE STATUS display in the upper left corner of the display. The PAGE STATUS displays are specific to the MODES. Please refer to the menu tree diagram in Figure 1 (earlier in this manual) for details.

Armed with this information, you're ready to navigate the menu tree of your T35-GFX.

### **The START/STOP Button**

The function of the START/STOP button can change depending on where you are in the menu tree. In general, pressing start anywhere from within the CHARGE, DISCHARGE and CYCLE modes will jump directly to the main MODE screen and start that MODE. Whenever the T35-GFX is executing a CHARGE, DISCHARGE, or CYCLE MODE, pressing the START/STOP button will stop the MODE execution. In the case of some parameters, the START/STOP switch will advance sequentially through a line of single characters, such as when you enter a new name for a setup.



## The Rotary Dial Switch and the Cursor

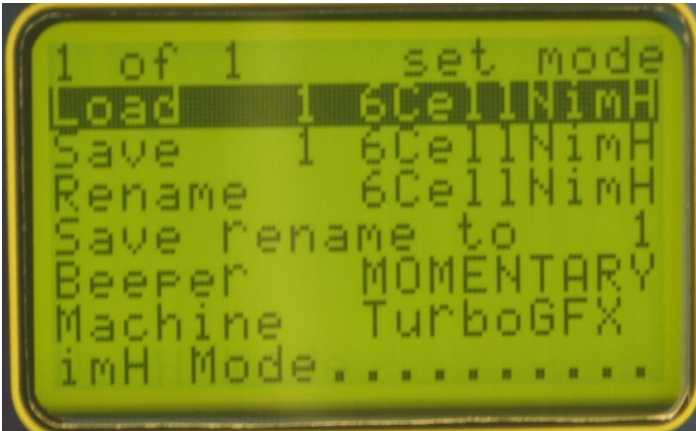

Figure 14: Typical selection screen showing the cursor line as was stated above.

Adjustable parameters appear as reverse highlighted lines on the SETUP screens. This is referred to as the CURSOR. Pressing the Rotary Dial Switch advances the CURSOR to the next adjustable parameter. When positioned at the last line, pressing the Rotary Dial Switch again repositions the CURSOR to the first adjustable parameter.

In general, when the CURSOR is positioned on a parameter, rotating the Rotary Dial Switch clockwise increases the setting and rotating counter-clockwise decreases the setting.

For parameters that require character-at-a-time editing, the START/STOP switch advances to the next character,

## Reinitializing non-volatile memory

As mentioned earlier in this manual, the T35-GFX comes from the factory initialized with ten different setups. Over time, you may modify these setups so much that you've forgotten all the settings you changed, and just want to get back to the default. Or, you might have encountered corruption in one or more of the stored setups. In either case, it's easy to reload the factory default settings. Perform the following steps:

1. Disconnect the pack or cells from the T35-GFX.
2. Remove power from the T35-GFX at the DC side of the power supply.
3. Hold down the "PAGE" button.
4. While holding it down, re-connect DC power.
5. Continue holding it down until you see the "SYSTEM INIT" message appear on the display. Then, you can release the PAGE button; in a few moments, the charge screen will appear, signifying that the T35-GFX is ready to use.

The re-initialization is now complete.

## NimH/NiCd Charge Mode

The T35-GFX can charge individual NimH/NiCd cells as well as packs of 2 to 8 cells. In order to charge 8 cell NimH/NiCd packs, the T35-GFX power source must be no less than 15 VDC. Under no circumstances shall the DC supply voltage be allowed to exceed 16 VDC.

The main display for the charge mode will show you the currently selected setup, the pack voltage, the charge rate, the mAHrs delivered to the battery, the elapsed seconds since the start of the charge cycle, the number of peaks set, the charge current setpoint, and the status of the Long Lockout and TurboFlex features.

## Charge Power Dissipation Limit

The T35-GFX will limit the maximum power dissipated within the charge output power MOSFETs to 185 watts.

As the charge cycle progresses, the output voltage will rise in order to maintain the setpoint current, because the pack voltage naturally rises. If the T35-GFX sees that the charge power MOSFETs have begun to dissipate power in excess of 185 watts, the T35-GFX will lower the voltage to bring power dissipation within safe limits. That means that the output voltage will be limited to the maximum safe value, and the charge current will drop below the setpoint.

When power limiting is in effect, the display will indicate this by displaying the message “POWER\*LIMIT\*ACTIVE”.

The power limit feature cannot be defeated, but in some cases you may be able to bring the T35-GFX out of power limit mode by reducing the power supply input voltage. Do not lower the input voltage below 12 volts.

## **Setting up a charge cycle**

As mentioned earlier on this manual, there are 10 stored setups in the T35-GFX, 5 for NimH/NiCd and 5 for LiPo. You may find that one of these setups is ideal. You may also find that one of the stored setups is a good starting point. You can load one of the setups as detailed in “Storing and Saving Setups,” below. Otherwise, you can check and set each parameter.

To navigate to the charge screen, press the MODE button until “chg mode” appears in the upper right hand corner of the display.

If you want accurate numbers from your charge cycle, you must use the smaller voltage sensing leads.

However, if you just want to charge (applies to NimH/NiCd ONLY), use of the sense leads for the charge cycle is optional. The peak dropback voltage will still be accurate; it will just be offset by the voltage drop of the pack connections.

## **Charge Rate**

Charge rate is the current delivered to the pack during the charge cycle. Units are in amps. This is how you get power into the pack. To set the charge rate, use the PAGE button to advance to the page “peak 1”. The page appears with the CURSOR positioned to the first parameter, which is the “Chg Amps”. Rotate the ROTARY DIAL SWITCH clockwise to increase the charge current; counterclockwise to decrease the charge current. The values will cease to change when you reach the built in limits for the parameter.

Make sure that your power supply is capable of supplying the current you select plus a bit more; the T35-GFX cannot make power out of nothing! Your DC supply must have sufficient power for the demand.

## **Peak Detect Voltage**

Peak Detect Voltage appears on the display as “Peak Det V”. This is the dropback voltage setpoint at which the T35-GFX will automatically terminate the charge operation. Units are in volts. Turn the ROTARY DIAL SWITCH to set the Peak Detect volts.

## **TurboFlex On/Off**

TurboFlex On/Off appears on the display as “Turboflex”. This is the setting that turns the TurboFlex feature On and Off. Rotating the ROTARY DIAL SWITCH will toggle the setting.

## **TurboFlex Level**

TurboFlex Level appears on the display as “Turboflex Level”. The TurboFlex level adjusts the discharge rates relative to the charge rate. The discharge rate of the burp is fixed at 5 amps.

The TurboFlex “burp” takes place once per second.

The duration of the TurboFlex discharge period every second is given by:

$$(((\text{Charge\_Amps} * 4 * \text{Turboflex\_Level}) + 17000) / 2) * 0.2 \text{uSec}$$

So, for a charge rate of 5 amps and a TurboFlex level of 5, the duration of the discharge burp will be  $(((5 * 4 * 5) + 17000) / 2) * 0.2 \text{uSec} = 1.71 \text{ mSec}$ .

## **Long Lockout On/Off**

Long Lockout appears on the display as “Long Lockout”. Normally, at the beginning of a charge cycle, the T35-GFX will disregard dropback voltage from the peak voltage detected up to the present point in the charge process for a duration of 60 seconds. This allows stabilization of the pack voltage for a short period before peak detection kicks in.

In order to overcome false peaking, Long Lockout can be activated. This will cause dropback voltage to be disregarded for 10 minutes, beginning at the start of the charge cycle.

Long Lockout will be reset to OFF after the cycle ends. This is done to avoid, as much as is possible, putting current into a fully charged pack for 10 minutes, which is what would happen if you connected a fully charged pack and Long Lockout was ON. Our philosophy is that the user needs to deliberately turn on long lockout, and then the user will not arbitrarily make this mistake.

## **# of Peaks**

The T35-GFX terminates the charge cycle when the peak negative dropback voltage is equal to the peak detect setting. Sometimes, the racer might want to repeak the cell or pack after the primary charging is finished.

Setting the “# of peaks” to 2 will enable an entire second charge and peak detect.

The settings for this second peak are found on the “peak 2” page in the charge mode. This includes charge rate (independent from the first peak charge rate), peak detect volts, turboflex, and delay.

## **Delay**

Delay appears on the “Peak 2” page of the charge mode screens. Use it to set the number of seconds between the first and second peak functions. One reason to use the delay is to let the pack rest after the first peak.

## **Interpreting the Results**

Much of the data collected and calculated during the charge cycle is displayed on the pages of the data mode screens. Where that is the case, it will be indicated in the text below.

### ***Peak Volts***

Peak volts is related to the charge function but it is located on page 1 of the data mode (“dat mode”) screen. This is the highest voltage recorded across the pack during the entire charge cycle. Seen on page 1 of 2 of the dat mode screens.

### ***mAHr***

Charge mAHr is the measure of the power delivered into the pack. Seen on the main charge screen.

### ***Charge Time***

This tells you how long it took to charge your pack. It is found on the main charge screen.

## **Other Features**

Moving from “Peak 2” to the “3 of 3” page exposes several miscellaneous functions, described below.

### ***Trickle Charge***

After the main portion of the cycle is through, setting Trickle Charge to ON will enable a fixed 100mA current into the pack for the purpose of trickle charging.

The trickle charge will be automatically disabled if the charge current is set below 2 amps.

Trickle, if enabled, will continue until the user stops the cycle.

### ***Delayed Start***

Wouldn't it be nice if you could time your charge cycle so it would finish just before the race? That's what this feature is for. Dial in the number of minutes for the delay; then press start. Your charge cycle will begin that many minutes after you press start.

## **Miscellaneous Features and Functions**

### ***Adjusting Charge Rate during a Charge Cycle***

The T35-GFX allows you to adjust the charge rate while the charge cycle is active. One use for this feature is to speed up the charge if you see that it won't be done soon enough. Do not use this if you want accurate readings; it's just a convenience to shorten charge time.

When you change the charge rate during a cycle, the 60 second lockout will be re-activated to assure that no false peaking results from the changed voltage across the pack due to a change in charge current.

### ***LiPo Charge Mode***

The T35-GFX can charge individual LiPo cells as well as packs of 2 to 3 cells.

The main display for the charge mode will show you the currently selected setup, the pack voltage, the charge rate, the mAHrs delivered to the battery, the elapsed seconds since the start of the charge cycle, the number of cells, and the charge current mAhr setpoint.

### **Setting up a LiPo charge cycle**

As mentioned earlier on this manual, there are 10 stored setups in the T35-GFX, 5 for NimH/NiCd and 5 for LiPo. You may find that one of these setups is ideal. You may also find that one of the stored setups is a good starting point. You can load one of the setups as detailed in “Storing and Saving Setups,” below. Otherwise, you can check and set each parameter.

To navigate to the charge screen, press the MODE button until “chg mode” appears in the upper right hand corner of the display.

It is recommended that you always use the smaller voltage sensing leads when charging LiPo cells or packs.

### ***Max Charge Seconds***

This is a user-settable safety time limit that will shut off the charge and signal an error if the charge time becomes equal to the setting. It is just another safety device which may be useful in the event of a malfunctioning LiPo pack. You should determine the typical charge time for a given LiPo pack at a given mAhr rate, and then set this just a bit longer. Be sure to consider charge inefficiencies; the mAhr setting will have to be increased over the mAhr rating on the pack in order to allow the pack to be fully charged.

It is also useful as a way to put a partial charge into a pack for the purpose of storage.

### **No of Cells**

Always make sure the number of cells set into this setting agrees with the number of cells specified on the LiPo pack.

### **Charge mAHrs**

Set this to the mAHr rating on your LiPo pack label. The Turbo35-GFX LiPo will charge at the ampere rate which will result in full mAHrs delivered in 1 hours time. For example if you have a 3200 mAHr pack, set the mAHr setpoint for 3200 and the Turbo35-GFX will charge at a rate of 3.2 amps.

Some manufacturers of LiPo packs specify the ability to charge at 2C, or even 3C rates. Check your manufacturer's pack data to determine if this is acceptable to your pack. At the time of this writing it is generally the case that charge rates higher than 1C can shorten the life of the LiPo pack.

NOTE: Unless specifically allowed by the manufacturer of the LiPo pack in question, never exceed a 1C charge rate.

### **Under and Overvoltage Considerations**

LiPo charge will be disabled and an error message displayed if the pack voltage exceeds 4.3V per cell or if it is less than 2.3V per cell.

If the LiPo pack voltage is between 2.3V and 3V per cell, the Turbo35-GFX LiPo will try to charge the pack at approx. 10% of the mAHr rate setpoint for 2 minutes in an effort to restore the pack voltage to 3V per cell. If the pack does not return to this level after 2 minutes, the charge cycle is terminated and an error message is displayed.

### **Viewing the Charge Graph**

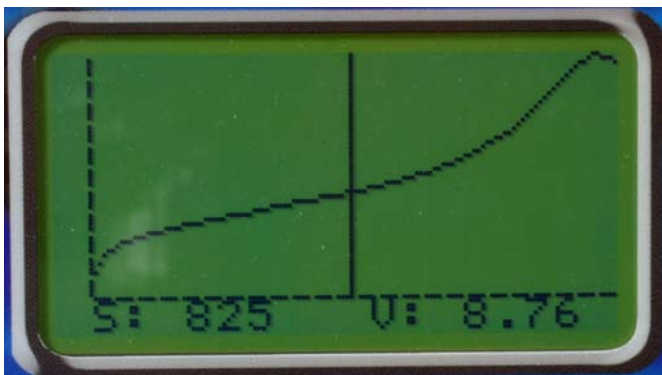

Figure 15: Typical charge graph

While the charge cycle is in process, pressing the MENU button will toggle back and forth between the main charge screen and the real-time charge graph. More will be said about the graphing feature later in this document.

### **NimH/NiCd Discharge Mode**

The T35-GFX can discharge individual cells as well as packs of 2 to 8 cells.

The main display for the discharge mode will show you the currently selected setup, the pack voltage, the discharge rate, the mAHrs drawn from the battery, the elapsed seconds since the start of the discharge cycle, the number of cells in the pack, the discharge current setpoint, and the discharge profile currently selected. Discharge is terminated when the pack voltage reaches the cutoff voltage setpoint. Factory presets are based on a starting point of 0.9 volts/cell, so that in most cases, you can simply change the # of cells setpoint and the cutoff voltage will be automatically adjusted to the correct value. However, the cutoff voltage is independently adjustable for maximum flexibility.

### **Discharge Power Dissipation Limit**

As with the charge function, the power dissipation of the discharge function is limited to protect the T35-GFX discharge MOSFETs.

A 7 cell pack will be limited to a maximum of 25 amps discharge rate and an 8 cell pack will be limited to a maximum of 20 amps discharge rate. However, because pack voltage decreases during discharge, there is no automatic (dynamically adjusted by the charger) current limiting in the discharge cycle.

### **Setting up a discharge cycle**

Again we remind you that there are a total of 5 setups storage memories for each chemistry in the T35-GFX. You may find that one of these setups is ideal. You may also find that one of the stored setups is a good starting point. You can load one of the setups as detailed in “Storing and Saving Setups,” below. Otherwise, you can check and set each parameter.

To navigate to the discharge screen, press the MODE button until “dchg mode” appears in the upper right hand corner of the display.

### **Discharge Amps**

Discharge Amps can be found on page 1 of 2 of the setup screens for the discharge mode. It appears on the page as “Dchg Amps”. Adjust for the desired discharge rate.

### **# of Cells**

Selecting the number of cells will automatically select the cutoff voltage. However, the value of the cutoff voltage may be customized, see “Cutoff Volts”, below.

### **Discharge Profile Mode**

Earlier in this manual we mentioned that the T35-GFX has some special discharge profiles for conditioning. These profiles are selected here. They are:

- STANDARD
- OVAL
- OFF ROAD

A standard cycle draws a constant discharge rate from the pack determined by the discharge setpoint, and is the most commonly used discharge profile.

These remaining two discharge profiles are specially designed for conditioning packs. As a result, the measured and calculated data gathered when using these profiles is invalid and should not be regarded as accurate.

#### **The Oval Discharge Profile**

The oval discharge profile is designed to draw current from the pack in a way that is similar to actual oval racing conditions. The profile is as follows:

45 amps for 1.25 seconds  
0 amps for 1.25 seconds  
3.6 amps for 1.25 seconds  
Repeat Cycle

#### The Off Road Discharge Cycle

The off road discharge profile is designed to draw current from the pack in a way that is similar to actual off road racing conditions. The profile is as follows:

45 amps for .25 seconds  
0 amps for .25 seconds  
22.5 amps for .5 seconds  
Repeat Cycle

When you start a discharge cycle with one of these conditioning profiles activated, the T35-GFX goes through a short calibration period at the start of the cycle to make sure it delivers accurate current. Then the profile is executed.

### **Cutoff Voltage**

The discharge cycle is terminated when the pack voltage reaches the cutoff voltage setpoint for the discharge cycle. Changing the cutoff voltage setting will affect the cutoff voltage only for the number of cells selected.

### **AIR ON/OFF**

This will turn the actual internal resistance measurement on or off. One result of this is that the momentary discharge current alterations made for the actual internal resistance measurement will not appear in the discharge graph, because they are not made when AIR is OFF. This will give you a nicer looking discharge graph, if desired.

### ***LiPo Discharge Mode***

The T35-GFX can discharge individual cells as well as packs of 1 to 3 cells.

The main display for the LiPo discharge mode will show you the currently selected setup, the pack voltage, the discharge rate, the mAHrs drawn from the battery, the elapsed seconds since the start of the discharge cycle, the number of cells in the pack, the discharge current setpoint, and the discharge profile currently selected.

Discharge is terminated when the pack voltage reaches the termination voltage setpoint. Factory presets for Lipo packs are predetermined at 3.0V times the # of cells. Simply change the # of cells setpoint and the discharge termination voltage will be automatically adjusted to the correct value.

### **Setting up a discharge cycle**

Again we remind you that there are a total of 5 setups storage memories for each chemistry in the T35-GFX. You may find that one of these setups is ideal. You may also find that one of the stored setups is a good starting point. You can load one of the setups as detailed in “Storing and Saving Setups,” below. Otherwise, you can check and set each parameter.

To navigate to the discharge screen, press the MODE button until “dch mode” appears in the upper right hand corner of the display.

## **Discharge Amps**

Discharge Amps can be found on the setup screen for the discharge mode. It appears on the page as “Dcg Amps”. Adjust for the desired discharge rate. Be sure not to exceed the maximum allowable temperature for the pack during discharge; consult the pack manufacturer's specs for this value.

## **# of Cells**

Selecting the number of cells will automatically select the termination voltage. Make sure the cell count matches the number of cells in the LiPo pack you are charging.

## **AIR ON/OFF**

This will turn the actual internal resistance measurement on or off. One result of this is that the momentary discharge current alterations made for the actual internal resistance measurement will not appear in the discharge graph, because they are not made when AIR is OFF. This will give you a nicer looking discharge graph, if desired.

## ***Under and Overvoltage Considerations***

NOTE: As with charging, there are under and over voltage checks built in which will terminate discharge if it can be determined that there is an abnormality.

## **Interpreting the Results**

Much of the data collected and calculated during the discharge cycle is displayed on the pages of the data mode screens. Where that is the case, it will be indicated in the text below.

### ***Discharge or Run Time***

This is simply the time it takes for the pack to reach the cutoff/termination voltage at the discharge rate setpoint. Use this to make pack comparisons. Seen on the main discharge screen, and on page 2 of 2 of the dat mode screens.

### ***mAH***

mAH is a measure of the current that has been drawn out of the pack over time. It should closely match the rating on the cell or pack when the cells are in good shape. Later, as the packs deteriorate or the matching gets out of sync, mAHrs delivered will decline. Seen on page 2 of 2 of the dat mode screens, and also on the main discharge screen.

### ***mWH***

mWH is a measure of the power that has been drawn out of the pack. See the section on “Learning about Cells and Packs for R/C Racing” above for a more detailed explanation of this parameter. Seen on page 2 of 2 of the dat mode screens.

### ***Average Discharge Volts***

The T35-GFX periodically measures the voltage across the pack while it keeps a running total of the number of measurements made. From this, it calculates the average voltage for the discharge process. A higher number



means that the pack consistently delivered more voltage over the course of the discharge process. Seen on page 2 of 2 of the dat mode screens.

### ***Average Discharge Volts at 1 Volt***

The same as above, except the T35-GFX stops measuring when voltage per cell reaches 1 volt. Seen on page 2 of 2 of the dat mode screens. This parameter is not applicable to LiPo cells and packs.

### ***Actual Internal Resistance***

A pack or cell powering a load can be approximated by a voltage source in series with a resistance, delivering power to a load, such as a motor. Ohm's Law

$$\text{Voltage (volts)} = \text{Current (amps)} \times \text{Resistance (ohms)}$$

tells us that current will decrease when resistance increases. Lower current means in turn a lower voltage delivered to the motor, which means less power delivered to the wheels.

So, it follows that one important way to compare packs is to measure it's actual internal resistance.

It's called actual internal resistance to distinguish it from relative internal resistance, mentioned elsewhere in this manual.

In the T35-GFX, actual internal resistance is measured by briefly altering the current at a predetermined time during the discharge process, and recording the voltage. Having voltage and current for two different currents, the actual internal resistance can then be calculated.

From Ohm's law:

$$\text{Resistance} = \frac{\text{Volts}}{\text{Amps}}$$

So it follows that:

$$\text{Actual Internal Resistance} = \frac{((\text{Volts @ Time 2}) - (\text{Volts @ Time 1}))}{((\text{Amps @ Time 1}) - (\text{Amps @ Time 2}))}$$

This is the basic math used by the T35-GFX to calculate actual internal resistance.

The T35-GFX presents actual internal resistance in milliohms. Lower is always better.

Below discharge rates of 5 amps, actual internal resistance measurements cannot be made with the T35-GFX.

## **Other Features**

### ***Viewing the Discharge Graph***

While the discharge cycle is in process, pressing the MODE button will toggle back and forth between the main discharge screen and the real-time discharge graph. More will be said about the graphing feature later in this document.

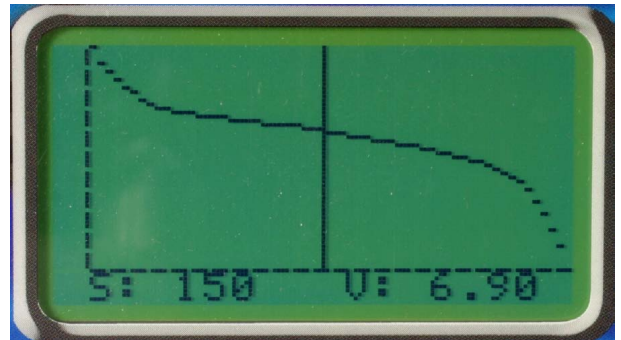

**Figure 16: Typical discharge graph**

## **Cycle Mode**

Cycling is just a way of automating a charge cycle followed by a discharge cycle. You will always have to get charge into a pack before you can get anything out; therefore cycling is a useful feature.

Cycling makes use of the charge and discharge features already discussed, and so most of the settings for a cycle are already complete from previous setup sessions already discussed.

## **Setting up a Cycle**

There are only two parameters to set for a cycle; everything else is set in the charge or discharge mode screens.

### **# of Cycles**

Simply specifies the number of charge/discharge cycles to be run sequentially. Why would you want to run sequential cycles? What if you wanted to do extended longevity testing to get an idea how long a certain type of cell might last before degrading? That's just one example; you may think of others.

### **Cool Down Minutes**

When you charge/discharge a pack, it gets hot. If you want to, you can set cool down minutes so that the pack has enough time to fully cool between cycles.

### **Relative Internal Resistance**

In order to measure relative internal resistance, both a charge and discharge cycle must be run, thus it is associated with a cycle. However, the actual measurement appears in page 1 of 2 of the data mode pages.

## **Cycling with the Turbo-GFX LiPo**

Cycling in LiPo mode works as you would expect; it first runs the LiPo charge and then the LiPo discharge functions.

### **Motor Run Mode**

You can use your T35-GFX to break in R/C motors. One of the most useful features of the T35-GFX for motors is its ability to deliver a full 20 amps of current to a motor!

The motor run feature uses the same output power MOSFETs as the charge feature, and so has the same power limitations. Therefore, to protect the MOSFETs, the motor cycle will be limited to a maximum power dissipation of 185 watts.

If the T35-GFX sees that the charge power MOSFETs are dissipating power in excess of 185 watts, the T35-GFX will lower the voltage to bring power dissipation within safe limits. That means that the output voltage will be limited to the maximum safe value, and the motor voltage will drop below the setpoint.

When power limiting is in effect, the display will indicate this by displaying the message "POWER\*LIMIT\*ACTIVE".

## **Setting up the Motor Run Cycle**

To set up your motor run cycle, use the PAGE button to move to page “1 of 1” in the motor function mode. Here you will find two settings.

### **Motor Volts**

Select the desired motor voltage here.

### **Run Time Minutes**

Select the run time in minutes here.

## **Using the GFX with a Commutator Lathe**

The T35-GFX is useful as the power source for a Commutator lathe, which is used to reshape the commutator contacts on the armature of your motor, to maximize conduction, and therefore power to the wheels.

## **Adjusting Motor Voltage While Running**

On T35-GFX units with firmware version 1.60 and above, the user can vary the motor voltage “on the fly”, that is, while the motor is running. Older firmware revisions that lack this feature may be upgradeable; visit our website,

<http://www.competitionelectronics.com/>

...or call CEI for details.

## **Data Mode**

The “dat mode” mode does not contain any cycles. Instead it is a collection of useful measured and calculated parameters, as well as the place where you access the stored graphs for the last charge and discharge cycles run on the T35-GFX. Many of the data mode parameters have already been mentioned in the descriptions of the charge, discharge and cycle sections; here are the descriptions of the remainder of the information it contains.

## Comm Setting



Figure 17: T35-GFX serial port connector

The T35-GFX has a built in serial port on its side that can be used to transfer certain data out of the unit. The comm. setting is the setting that selects the format of data being sent out of the T35-GFX. There are five selections:

- GRAPH MAN
- GRAPH AUTO
- COMP MAN
- COMP AUTO
- REAL TIME

### **MAN(ual) and AUTO(matic)**

The difference between MAN(ual) and AUTO(matic) is that if a manual selection is made, the user will have to first navigate to the Comm line, then press the START button to print. AUTO settings will print automatically after the cycle is complete.

Note that the T35-GFX uses no hardware or software handshaking. When it's time, it just spits out the data with no regard for whatever it might be attached to.

## **GRAPH MAN and GRAPH AUTO**

GRAPH MAN and GRAPH AUTO produce an ASCII (drawn with characters) graph of the discharge curve for the last discharge cycle. At the top of the graph are additional measured and calculated parameters. The ASCII graphs are designed to be sent directly to an ASCII printer. However, because the data is transmitted through a serial port, a device known as a Serial to Parallel converter is necessary in order to make a direct connection between the printer and the T35-GFX.

Alternately, the ASCII graph may be captured using a PC, and then sent to the PC printer like any other document. These features are discussed in more detail later in this manual.

## **COMP MAN and COMP AUTO**

COMP MAN and COMP AUTO are intended for PC interface for TurboLabel use. We'll talk about TurboLabel a bit more in due time.

## **REAL TIME**

REAL TIME stands for real time data output.

Real time data output will give more data with a higher resolution (smaller measurement time interval) than the stored data feature mentioned above; it is measured and output once per second, as opposed to stored data that is collected once every 5 seconds. For another thing, real time data is output as it occurs, and so there is no storage size limitation on real time data. The T35-GFX data output will continue for as long as the charge or discharge lasts.

How you use this data is up to you; you could import it into a Microsoft™ Excel™ spreadsheet and do fancy analysis on it; you might also print a very nice color graph. You might even write a program to use this data, and a number of our customers have done exactly this.

## **The Serial Port**

The comm link to the outside world is a standard RS-232 format (also known as EIA232) using a DB-9 connector with female pins.



**Figure 18: T35-GFX serial port connector**

### ***Hardware Configuration Details***

The connector is intended for interface to an IBM-compatible PC serial port and is wired for use with a standard PC serial cable; if you are in the US, you can get this cable at any Radio Shack® as of the time of this writing. As USB is becoming more and more popular on PC's, some of our customers may not have a serial port on their computers. In this case, CEI recommends the purchase of a USB to Serial adapter device. These can be had for between \$20.00 (Internet) and \$40.00 (your local "big-box" store).

Here is the schematic for those who do not have a Radio Shack at their disposal.

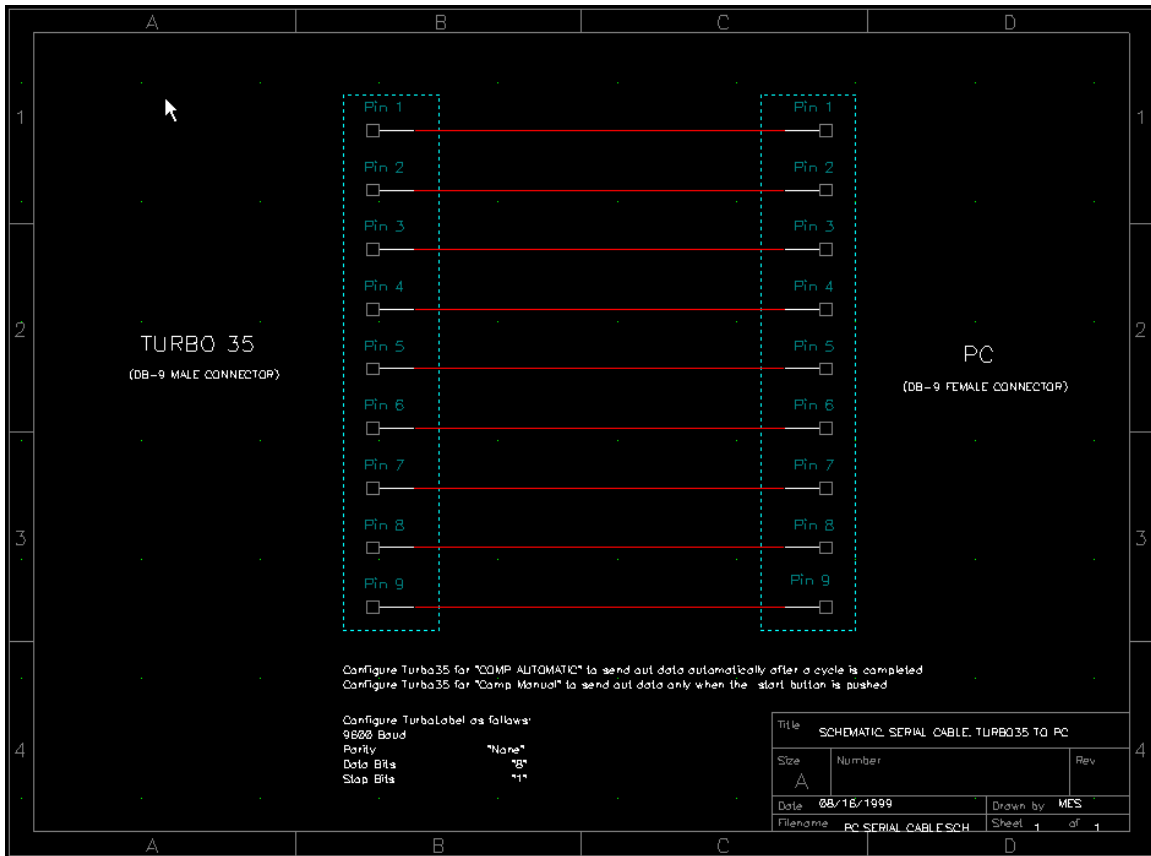

Figure 19: PC Serial Cable for use with T35-GFX

### Communications Configuration Details

The serial port on the T35-GFX is preconfigured for the following settings:

- 9600 Baud
- 8 Data Bits
- 1 Stop Bit
- No Parity
- No Handshaking

Whatever device you connect to the T35-GFX, it will have to be configured with these parameters in order to achieve successful communication. Usually, this is a function of the program you are using on the PC, but on some very simplistic programs, you may have to edit parameters in whatever your PC and operating system provides for manipulation of the serial com port.

### Real Time Data Format

What does the data look like as it comes out of a T35-GFX? Here's a sample:

8.157, 5.743, 0  
8.190, 6.051, 1  
8.212, 6.036, 2  
8.238, 6.002, 3  
8.256, 6.007, 4  
8.271, 6.012, 5  
8.289, 6.012, 6  
8.304, 6.012, 7  
8.315, 6.017, 8  
8.326, 6.017, 9  
8.340, 6.021, 10  
.....

The format for the data is often referred to as .csv or, comma separated value format. Helper programs from Microsoft® and others know how to read these types of files, and separate lines into individual values. Each line contains three values, the first is the pack voltage, the second is the pack current, and the third is the seconds since the start of the operation. This sample happens to be from a charge operation. It is only a part of the entire file generated, as there is a line for every second.

### ***Interfacing an ASCII printer***

As noted above, the T35-GFX can produce an ASCII discharge graph. This output is meant to be sent directly to a printer and makes use of standard ASCII codes to generate characters for the graph. When this feature was first introduced, almost all printers widely available to the average consumer were of the ASCII-compatible, dot matrix type. Some time after that, the laser printer was introduced, and then the ink jet printer. As the Windows family operating systems became more and more popular, as technology advanced, and as competition forced prices down, ASCII-compatible printers have become more and more scarce. Form-based printers such as laser and ink-jet types have become the norm, and dot matrix printers have faded into the background.

As a result, use of this feature has become less widespread. However, if you still want to interface a printer directly to the T35-GFX, it can be done.

First, you will need to be sure that your printer is compatible with ASCII (American Standard Code for Information Interchange) data.

The second hurdle to overcome is that you will most likely have to convert data coming out of the T35-GFX in serial format to standard parallel data format compatible with IEEE-1284 Centronics-compatible printer ports. To do this, you will need a serial to parallel adapter. This is not simply a chunk of plastic with the right connectors on each end; this is an electronic device that converts data from one format to the other electronically.

Below is a picture of the gear typically required to interface the T35-GFX to a printer, along with a point by point description of how to go about it.





**Figure 20: Serial to Parallel conversion gear**

1. On top of the converter are a series of small switches. Note that they are labeled: “1”-”8”. Also note the markings: “off”, and “on”. Using a pointed object such as a pencil, set the switches as follows:

switch	setting
1	ON
2	ON
3	OFF
4	ON
5	OFF
6	OFF
7	OFF
8	OFF

2. Connect cables as shown in the picture above. Connect the free end of the smaller PC serial cable to your Turbo35’s RS-232 serial port. Connect the free end of the larger parallel cable to the Printer’s parallel input connector. The cables and adapter shown are available from any Radio Shack store, or from their web site ([www.RadioShack.com](http://www.RadioShack.com)). The Radio Shack part numbers are as follows:

Standard PC Printer Cable	N/A
Female DB9 to Male DB25 Serial Port adapter	#26-209B
6 ft. Serial RS-2432C Cable Male DB9 to Female DB9	#26-117



This Serial <-> Parallel converter is made by B&B Electronics Mfg. Co., Inc. The B&B part number is 232SPS2. More information about this device, including a user's manual in .PDF can be found at their website, which is [www.bb-elec.com](http://www.bb-elec.com). For European customers, you can use their European website, which is [www.bb-europe.com](http://www.bb-europe.com).

The Radio Shack and B&B trademarks are the exclusive property of these companies.

Note: Some previous models of the T35 required a "Null modem" adapter in order to make a successful connection to the T35 serial port. The T35-GFX does not require this adapter.

## Using the Graphing Features

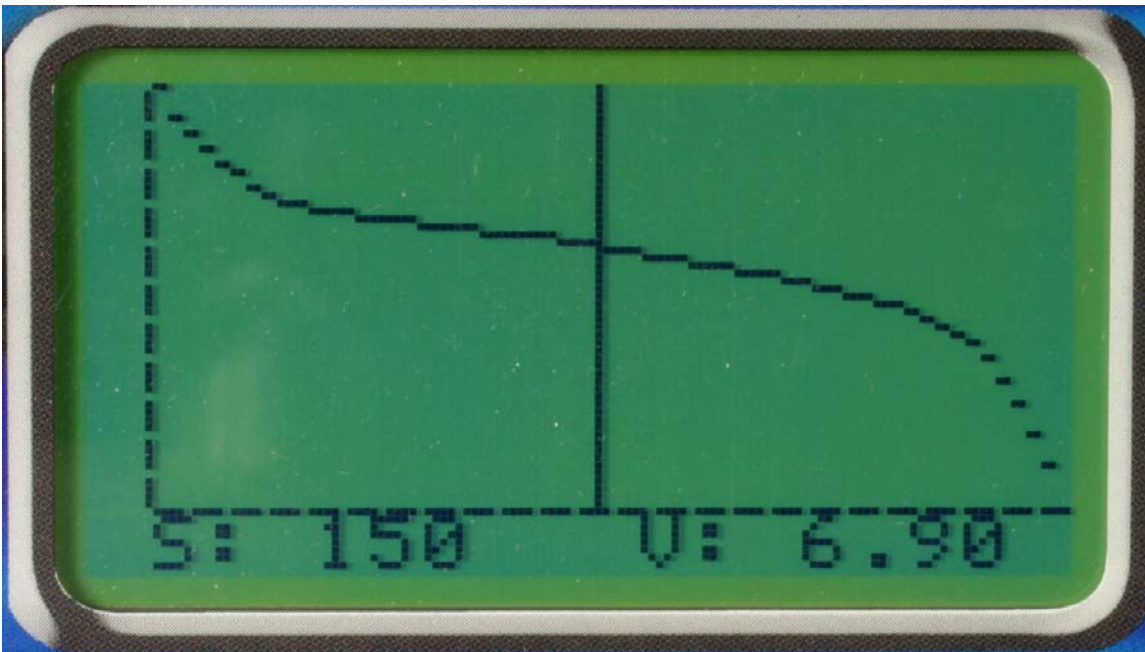

Figure 21: Discharge graph

CEI was the first to introduce graphing features in R/C chargers/dischargers, and the T35-GFX was the first self-contained R/C charger/discharger to put them right on its display!

The graph can show important information at a glance. For example, you can see the shape of the graph. Does it look normal, compared to your experience with charging and discharging this pack in the past?

The Data Mode page 1 of 2 contains two lines having to do with graphs; they are:

- Dcg Graph
- Chg Graph

To see the graphs, position to one of these lines. If there is data in the graph, the parameter will show a "Y" at the end for "YES". Otherwise, it will contain an "N" for "NO".

If it says "Y", then press the START button while positioned on the line to reveal the graph; press START again to go back to the page display.

## Data Collection and Storage

Data points for the graphs are collected and stored in nonvolatile memory in the T35-GFX during charge and discharge operations. Data storage is limited to the most recent 500 data points for the charge cycle and 500 data points for the discharge cycle. Data points are collected every 5 seconds, meaning that a maximum of 2500 seconds worth of data can be collected for each of the charge and discharge cycles. If timing exceeds 2500 seconds, the earliest data will be overwritten by the newer data, which is equivalent to saving the most recent 500 data points in either case.

Data will not be stored during charging if TurboFlex is active.

## Using the Cursor

The main feature of the graphing screen is the cursor, or vertical line that appears on the graph screen. Rotating the rotary dial will move the cursor from point to point across the graph. As it positions on a point, the point time and voltage value will be displayed at the bottom.

## Supply Voltage

On page 2 of 2 of the dat mode screens, the only parameter present that hasn't been described is the Supply Volts. This, of course, is the DC supply voltage present on the T35-GFX power supply leads.

The T35-GFX has some low power protection features built in. If the power supply dips below 4.4 VDC, the T35-GFX will stop any cycle and perform a shutdown, alerting the user with a message:

**\*SYSTEM\*SHUTDOWN\*\***

At this point it is necessary to disconnect the T35-GFX from the supply and any attached cells; then restart the charger from scratch.

If the power supply drops below 10 volts but stays above 4.4 volts, the T35-GFX will suspend any charge cycle in progress, then give the message:

**!POWER\*SUPPLY\*BAD!**

Should power return to normal, any charge cycle in progress will be restarted, in order to attempt to carry out the charge function in case the racer was depending on the pack being charged.

## Setup Mode

The T35-GFX stores 10 program setups in nonvolatile memory for recall; 5 for Nimh/NiCd mode and 5 for LiPo mode. Which are visible depends upon which battery chemistry is selected. Here's how it works.

## What Settings are Saved/Recalled in a Setup?

The following parameters are saved in a setup:

### *General*

Machine Name

Setup Name

Comm Mode

Beeper State

### *Charge*

# of Peaks

Trickle Status On/Off  
Charge Cycle 1 Charge Amps  
Charge Cycle 1 TurboFlex Status On/Off  
Charge Cycle 1 Delay Seconds  
Charge Cycle 1 Peak Detect Volts  
Charge Cycle 1 Turboflex Level  
Charge Cycle 2 Charge Amps  
Charge Cycle 2 TurboFlex Status On/Off  
Charge Cycle 2 Delay Seconds  
Charge Cycle 2 Peak Detect Volts  
Charge Cycle 2 Turboflex Level  
LiPo mAhr charge setpoint  
LiPo # of Cells  
LiPo max charge seconds

### ***Discharge***

Discharge Cycle Cell Count  
Discharge Cycle Cutoff Volts 1 Cell  
Discharge Cycle Cutoff Volts 2 Cell  
Discharge Cycle Cutoff Volts 3 Cell  
Discharge Cycle Cutoff Volts 4 Cell  
Discharge Cycle Cutoff Volts 5 Cell  
Discharge Cycle Cutoff Volts 6 Cell  
Discharge Cycle Cutoff Volts 7 Cell  
Discharge Cycle Cutoff Volts 8 Cell  
Discharge Cycle Discharge Amps  
Discharge Cycle Discharge Mode  
Actual Internal Resistance Status On/Off  
LiPo Discharge Amps

### ***Cycle***

Cycle Cooldown Seconds  
Cycle Count

### ***Motor***

Motor Cycle Motor Run Seconds  
Motor Cycle Motor Volts

### ***Storing/Retrieving Setups***

Setups are accessed from the “set mode” screen. Here is the mechanics of storing, retrieving, and renaming setups. Although not shown, LiPo mode is similar in operation.

## Loading Setups

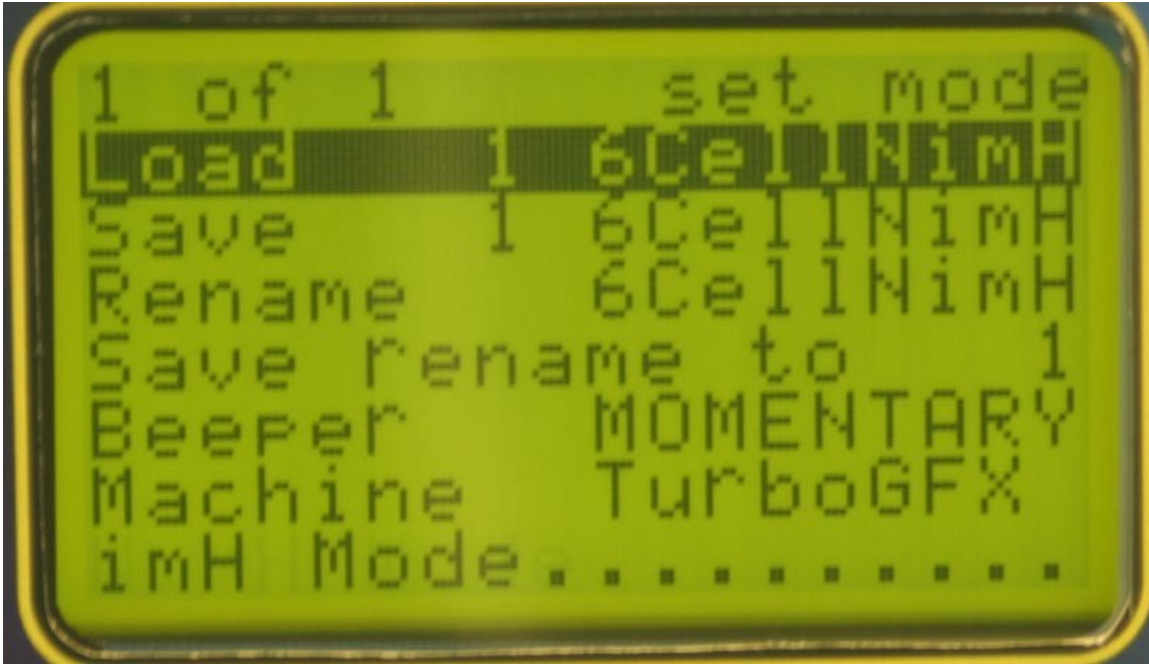

Figure 22: Loading a setup

To load a setup, navigate to the Load line on page 1 of 1 of the set mode screen. When highlighted, rotate the dial. As you do, the setup number and name will change. When you see the setup you want to load, press START. This loads the selected setup into the T35-GFX active memory.

## Saving Setups

To save the current setup, navigate to the Save line on page 1 of 1 of the set mode screen. If you wanted to save to the same location, make sure the current setup shown in the Save line is the one you want to update. Otherwise, selecting a different setup number will overwrite the current setup data in that setup memory with the data currently in the active memory of the T35-GFX. As above, press START to make the save.

## Naming/Renaming Setups

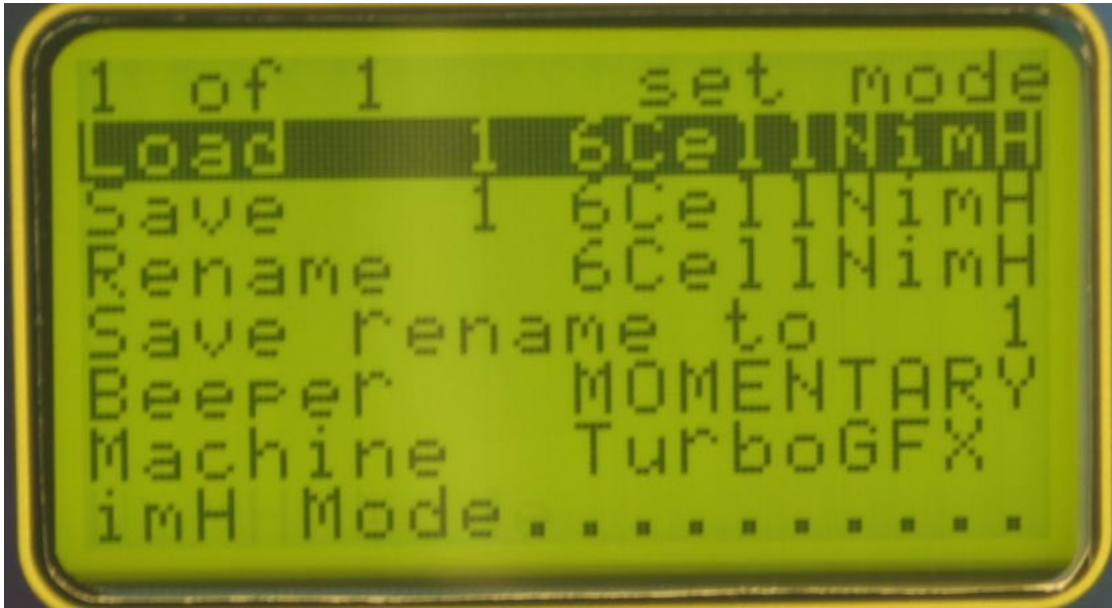

Figure 23: Renaming a setup

A saved setup can be renamed in two steps.

First, navigate to the Rename line on page 1 of 1 of the set mode screen.

When the cursor is positioned on the Rename line, the first character position of the name will begin to flash. In this line, the START button functions differently. It advances the character position to the next character. To change the current character, rotate the rotary dial. Proceed character by character until the full name appears in the display line.

The second step is this: advance to the “Save Rename To” line. Rotate the rotary dial to select the setup to rename; then press START to rename the setup.

## Editing Setups

To edit a setup,

- load the setup into T35-GFX active memory
- make changes to the desired settings in the active memory
- save the setup.

That’s all there is to it.

## Beeper

The T35-GFX contains an internal beeper that signals the end of cycle, as well as a button press. The beeper action at the end of the cycle can be set to the OFF, MOMENTARY, or CONTINUOUS modes.

## Machine

This setting sets the machine name for computer data output. It allows external programs like TurboLabel to distinguish between different machines.

## TurboLabel Output

The T35-GFX has a selection in the COMM DATA parameter line called COMPUTER DATA OUT. This is the setting meant to be used with TurboLabel. The T35-GFX packet format is compatible with older T35's, even though the T35-GFX does not generate all the data that older T35's do.

### *Using TurboLabel with the T35-GFX*

CEI has a program called TurboLabel that allows you to design and print labels for your cells and packs using data collected from T35-GFX and TM4-35 chargers/dischargers and matchers. For a complete description of TurboLabel and its capabilities, see

<http://www.competitionelectronics.com/turbolabel.html>

It would be a good time investment to read the TurboLabel manual, found at this link, as it contains a lot of useful information about printers, data transfer, etc.

### *TurboLabel Computer Data Format*

The following is a description of the data packet structure for the Turbo35 GFX.

All actual data fields are separated by commas.

The packet will have certain differences based upon whether it is a single cell or multicell pack. NOTE: There is no LiPo data in the packet at this time.

Field Number	Typical Field Value	Field Description
1	“{“	Start of data packet
2	“*“	Start of data group(included for compatibility with TurboMatcher 4)
3	“02”	Machine code number. Hard-coded into the machine. TurboMatcher4 is #01, Turbo35 is #02. Turbo35 GFX is #03 Two digits. Leading zeros included.
4	“0280”	Discharge time in seconds. XXXX, Leading zeros included.
5	“ 04.49” or “1.134”	Ave Discharge voltage. DP and significant digits change based upon the voltage of the cells tested. Under 2V will give 3 places to the right of the decimal point. Five digits. Leading zeros included.
6	“ 04.49” or “1.134”	Ave Discharge voltage when pack voltage divided by number of cells first reaches or dips below 1 volt. DP and significant digits change based upon the value of the voltage. Under 2V will give 3 places to the right of the decimal point. Five digits. Leading zeros included.
7	“N”	Discharge Mode. Values are: ‘N’ (normal) ‘V’ (oval) ‘R’

		(off road).
8	3.60	Cutoff Volts for discharge. X.XX with leading zeros.
9	6	Number of cells. One digit.
10	Turbo35 :	Name 1. Always 9 chars. User editable.
11	Turbo35 :	Name 2. Always 9 chars. Not user editable.
12	1	Setup number; 1 digit. 0 through 9 represents 1 through 10.
13	174	Relative internal resistance; XXX, leading zeros included.
14	23.9	Actual Internal resistance. XX.X, leading zeros included.
15	20	Discharge amps. XX; Leading zeros included. Since the GFX can do fractions of an amp, this parameter is rounded to the nearest 1 amp to maintain compatibility with the existing T35 machine option.
16	1275	Charge Time. Always XXXX. Leading zeros included.
17	06.87	Charge Peak Volts. XX.XX with leading zeros included.
18	0120	Delay 1. XXXX; leading zeros.
19	0000	Delay 2. 0000; Always all zeros, as the GFX has no third peak.
20	05.0	Charge 1 amps. XX.X with leading zeros.
21	05.0	Charge 2 amps. XX.X with leading zeros.
22	00.0	Charge 3 amps. Always 00.0 with leading zeros, as the GFX has no third peak.
23	0.03	Peak 1 Detect. X.XX with leading zeros.
24	0.03	Peak 2 Detect. X.XX with leading zeros.
25	0.00	Peak 3 Detect. Always 0.00 with leading zeros, as the GFX has no third peak.
26	1555	mAHrs. XXXX with leading zeros.
27	013981	mWHrs. XXXXXX with leading zeros.
28	ON or OFF	Turboflex 1 on/off 3 digits “ ON” or “OFF”
29	3	Turboflex 1 level 1 digit
30	ON or OFF	Turboflex 2 on/off 3 digits “ ON” or “OFF”
31	3	TurboFlex 2 level 1 digit
32	OFF	Turboflex 3 on/off 3 digits Always “OFF” as the GFX has no third peak.
33	0	TurboFlex 3 level 1 digit. Always 0 as GFX has no third peak.
34	#	End of data group (inserted for compatibility with TurboMatcher 4
35	}	End of Packet

## Using the PC and Helper Programs

By “helper programs”, we mean programs that can be used with your T35-GFX to help you in collecting and formatting data from your T35-GFX.

The first thing you have to realize about using helper programs is that CEI can’t teach you how to use Windows. You will have to understand that learning the PC or Mac and its operating system is a prerequisite for getting the most out of helper programs used with the T35-GFX.

You can obtain very good books on the Windows operating system at your local chain bookstore or computer store, or on the Internet Videos are also available. So there is no dearth of how-to information about PC usage. Take the time to learn your way around the computer. That would include being able to locate files on your PC, move them, delete them, rename them, copy them, etc. Become familiar with the computer operating system interface; it will pay big dividends down the road.

## **HyperTerminal**

### **HyperTerminal Quick Start**

HyperTerminal is a program included with the Windows operating systems, starting with Windows 95. We mention it here for that very reason; it is included with all newer Windows operating systems (not Vista), and although it's a bit clunky in some ways, it has the basic capabilities we need to capture and manipulate data. Here's a quick step-by-step description of how to use HyperTerminal with your T35-GFX:

1. Locate the HyperTerminal application on your PC and start it.
2. HyperTerminal will present the user with a dialog box in which you may name a new connection and select an icon for it. Enter an appropriate name and choose an icon you like. Click once on the "OK" button.
3. A dialog box entitled "Connect to" will appear. Click on the arrow of the drop-down combo box entitled "Connect Using". Select "Direct to Comx" where "x" is the number of the Com port on your PC you intend to use. For most PC's, this will be Com1, but this can vary, especially with laptops. Newer PC's may not have a Com port; if so, obtain and install a USB-to Serial converter, then start again from the top of these directions. Otherwise, click once on the "OK" button.
4. Another dialog box will appear in which you can set the communications parameters for the Com port you selected. Select Bits per Second = 9600, Data Bits = 8, Parity = None, Stop Bits = 1, and Flow Control = Hardware. Click once on the "OK" button.
5. Use the mouse to select (click on) File|Save from the main HyperTerminal menu. This will save the connection you have just created.
6. Now, use the mouse to select File|Exit to exit the program. When you do, the program group window will reappear from underneath where the HyperTerminal was. You will see the icon you selected appearing in the window, with the title you selected appearing underneath. Double-click on the icon to activate your connection.
7. Now, make sure that you have connected the 9 pin serial PC cable to the T35-GFX. Connect the PC end of the cable to the com port you selected.
8. On the T35-GFX, go to the "dat mode" screen and navigate to the "Comm" line. Select the desired data output type as described earlier in this manual. Then, press the "Start" key. If you have done everything correctly, the selected data will be transmitted and will appear on the HyperTerminal window.

### **Capturing and Saving Data**

Ok. I said I wasn't going to do this, but here is a brief, but detailed description of how to get around in Windows in order to capture files using HyperTerminal.

Locate the menu selection at the top of the HyperTerminal program window that says "Transfer." Use your mouse and left click one time on this menu item text. A drop down menu will appear; move the mouse pointer down by moving your mouse until the menu item "Capture Text" is selected and left click one time. A screen very similar to the one below should appear:



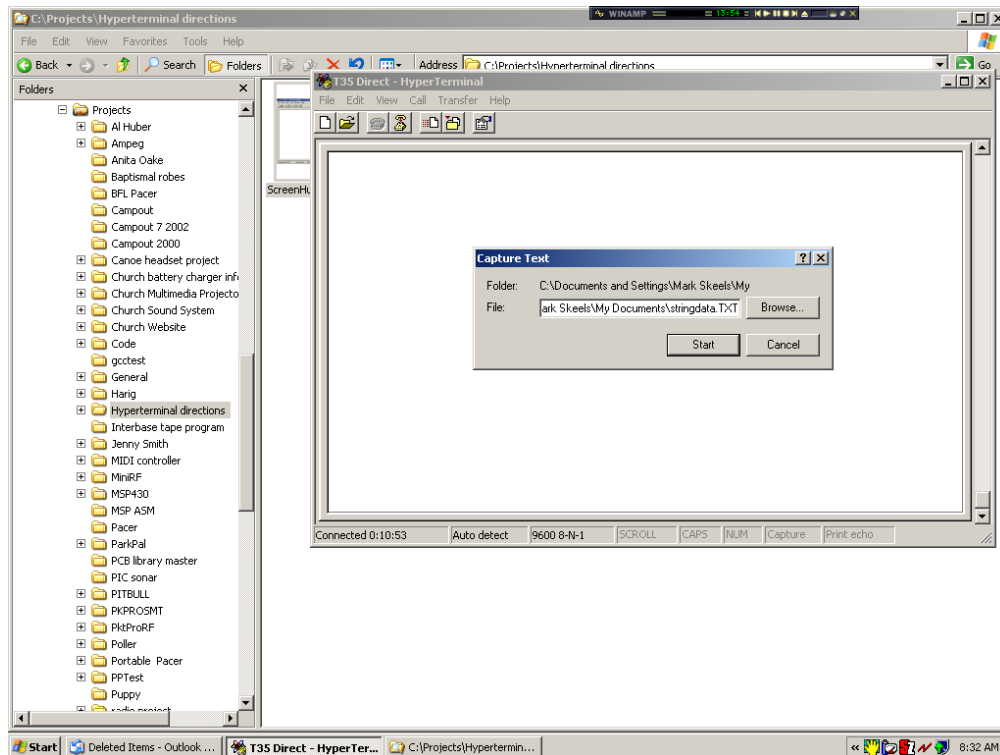

Let's take a closer look at this window...

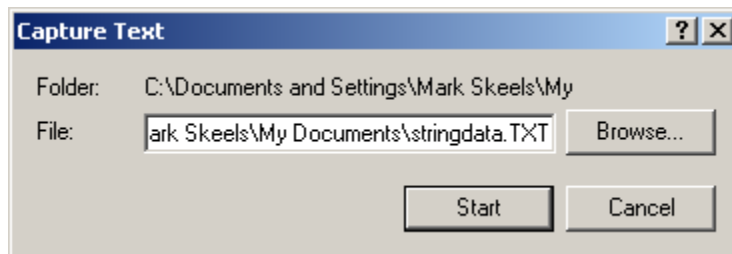

As you can see, the “path” is displayed in the text box. A path is just a string of characters with “backslash” characters that denote folders. Your computer’s hard drive is organized as a series of folders within folders, and this is the paradigm that we use to understand “where” data files are located.

The name of the file is found at the far right side of the path text string; in this case the name of the file is “stringdata.txt.” You can control the file’s name and its contents by naming it at this point, in like manner. In general, perform this step first, each time you want to capture data from the T35-GFX, in order to control what data appears in the text file. Makes sure you choose a different, new name, each time you want to save a separate set of data, so that each set of data gets saved individually.

Remember to be careful only to rename the portion of the string between the last “\” and the “.TXT”. Don’t use punctuation characters, except for space, in this portion of the string.

After you have completed the naming process, left click the “Start” button on this window. This will cause HyperTerminal to collect all data from this point forward into a file called “stringdata.TXT”.

Now, transfer the data you want to save by configuring the T35-GFX and starting a cycle or printing other data. Don’t worry about any data that might have appeared on the window before this point; only what you transfer from this point forward will appear in the file “stringdata.TXT”.

When you have transferred all the data that you wanted to save, again left Click the “Transfer” menu Item on the main HyperTerminal window, and then left click “Capture text...”. Another submenu will appear; left-click the “Stop” menu selection. At this point, the data is written into a file called “stringdata.TXT” on your computer’s hard drive.

To find and use this file, open a program called “Windows Explorer” (NOT Internet Explorer.) Below is a screen shot of what this program looks like. Again, things can vary greatly depending on how you have your Windows operating system configured, and which Windows operating system you are using. To cover these things is beyond the scope of this document; seek out a video or book on basic Windows Operating System Commands.

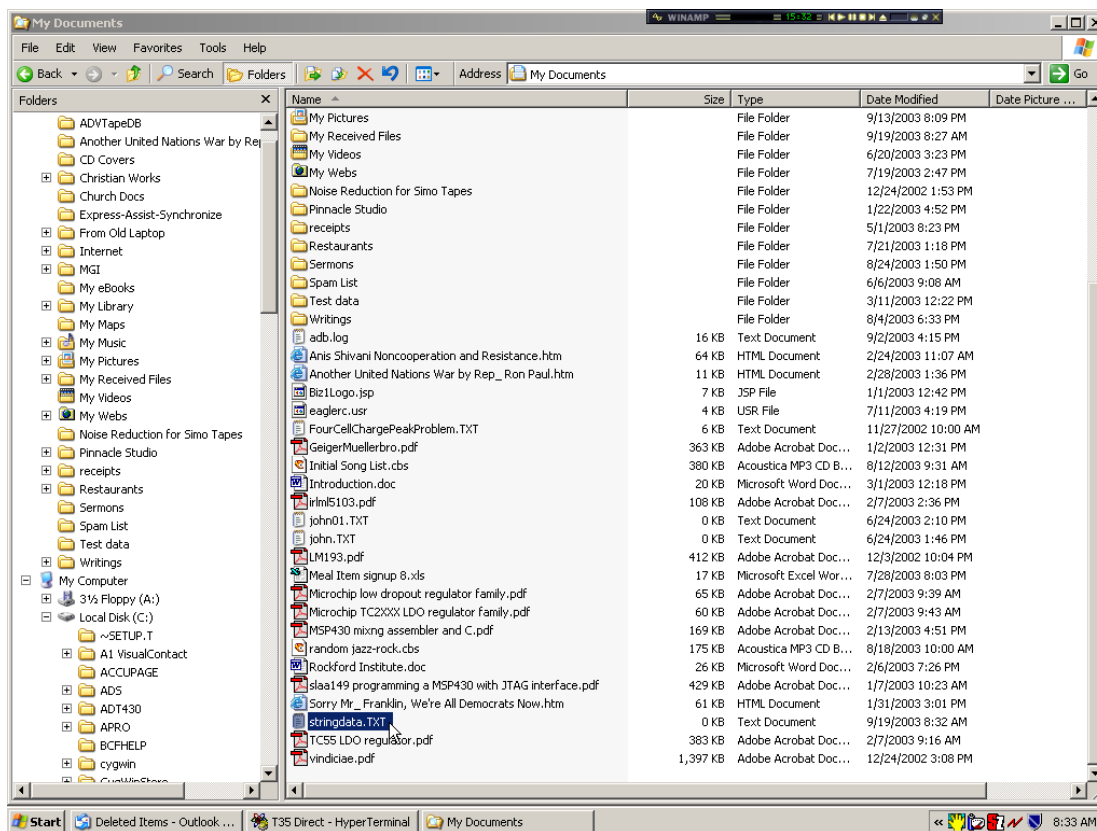

Now, you will need to “navigate” by double left clicking on the folders in the left-hand window until the right hand window displays the contents of the folder where you have previously told HyperTerminal to store the file

“stringdata.TXT”. Remember the path data in the small window in HyperTerminal? This exactly corresponds to what you see graphically in this program window.

I stored my file in the folder “My Documents”. This will be confusing, because Windows showed a complete path in the HyperTerminal window, but here displays it only as My Documents. Again, there are good reasons for this; but you have to understand more of how Windows works and its design philosophy, in order for this to make sense. However, you can store it “anywhere” on the hard drive.

When you see the file displayed in the left-hand window, double left click on it; if you have named your file with a “.txt” extension, a built in program called Windows Notepad will automatically open up and display the contents of the file...

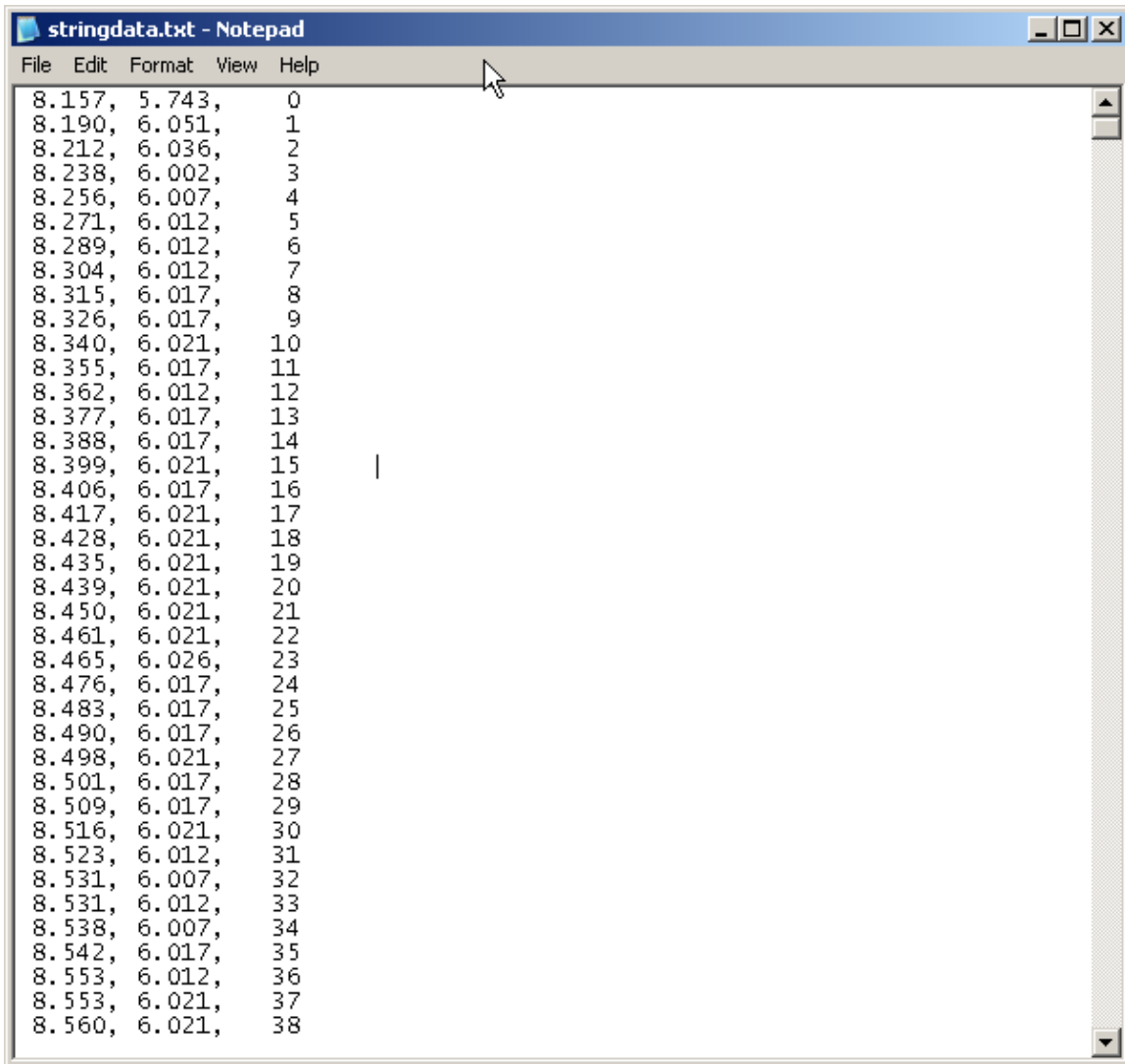

Notice how your data has been captured in this file; Left click File, then Print Menu selections to print this data.

In order to store other data, just repeat this process, using a different file name.

## Tera Term

HyperTerminal, as mentioned previously, is a bit clunky. If you want an alternative, Google the Internet for a program called Tera Term. It's free, and good!

## Excel®

Microsoft® Excel® is a spreadsheet program with a lot of very nifty features. Learn to use it and you'll not only analyze T35-GFX data, you can balance your checkbook, etc.

For use with the T35-GFX, we're interested in its ability to import data. In order to try this, you'll have had to have previously captured real-time data from your T35-GFX in a file. If you haven't done that yet, do it now; then return to this section.

To import data into Excel, launch the Excel application, and using the File|Open menu selection, locate and open the captured file.

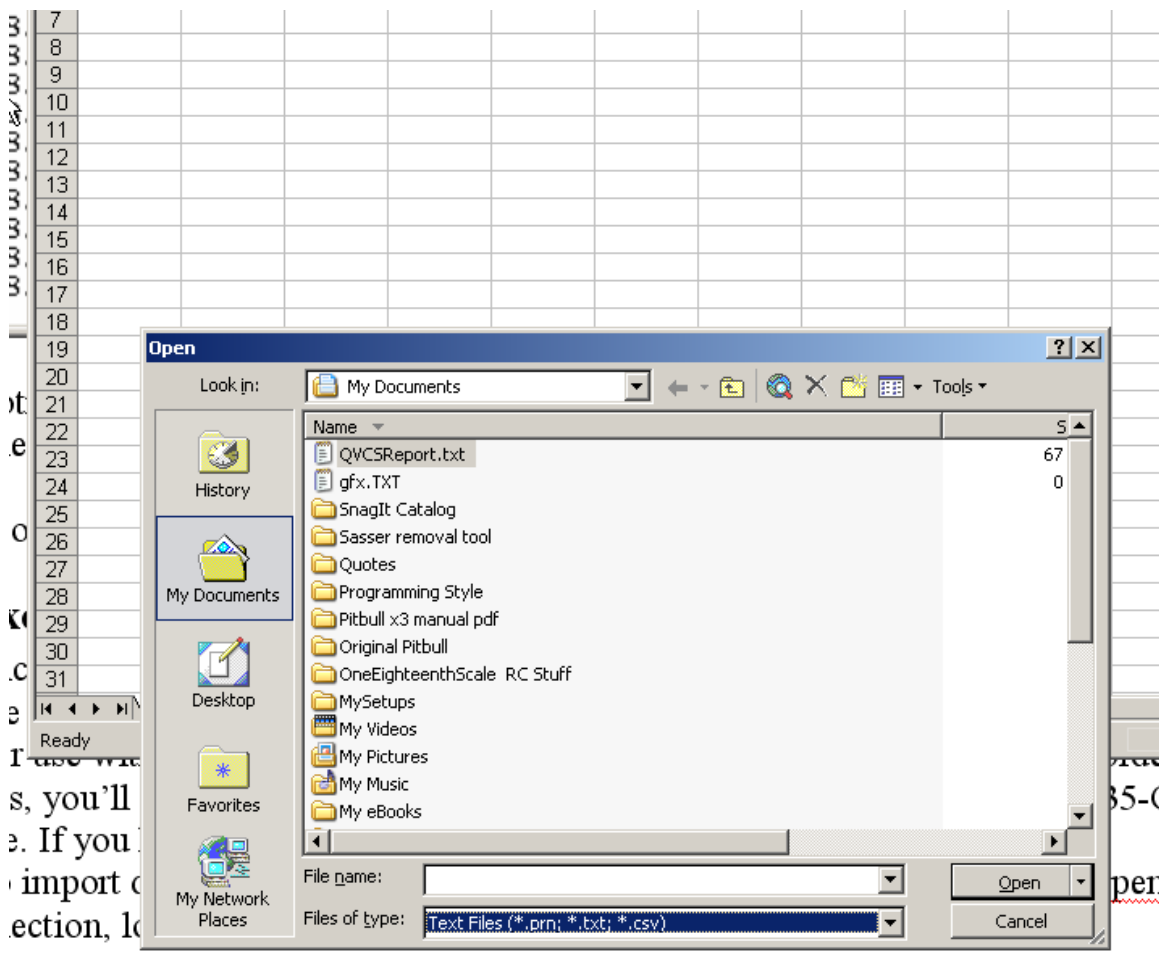

Notice that in the Open dialog box, "Files of Type" shows a selection of .csv and .txt. You must do this. A series of dialog boxes called the "text import wizard" will appear to guide you through the import procedure.

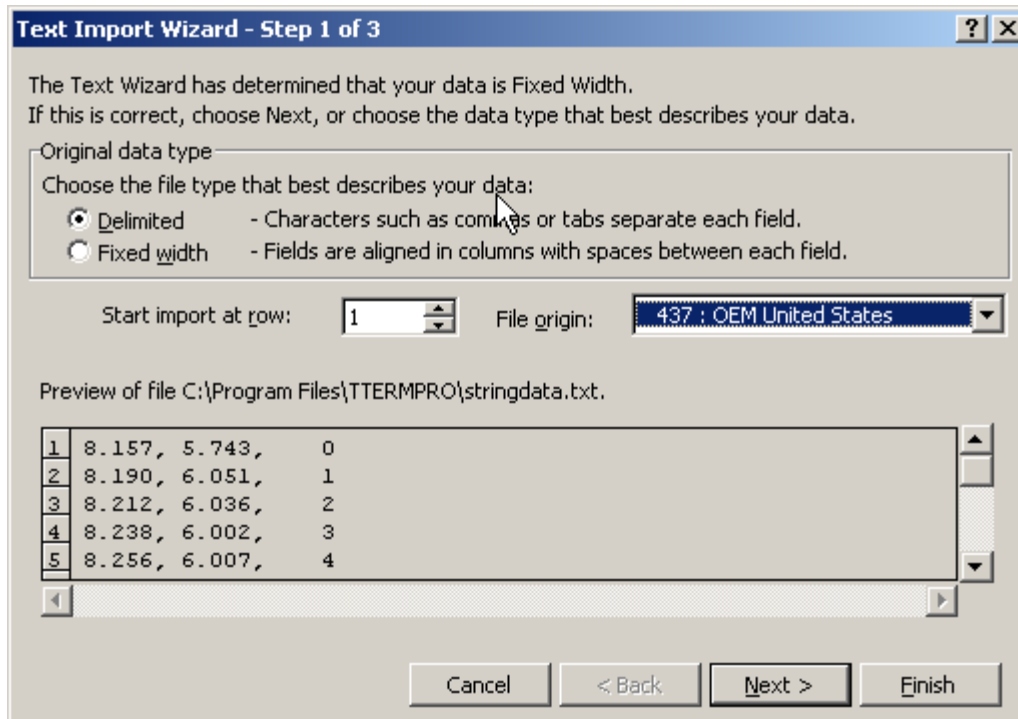

Be sure to select the “Delimited” for Original Data Type. Then click “Next”.  
In this window, make sure to select the “Comma” checkbox for the Delimiter type.

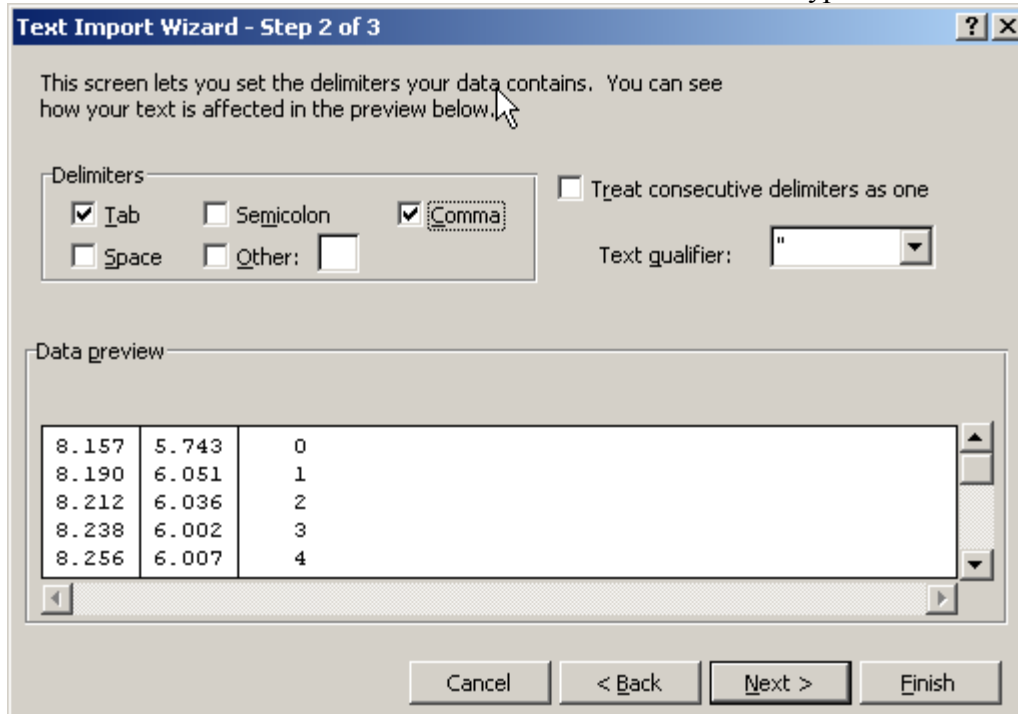

Then click “Finish”.  
Data will appear in your spreadsheet.

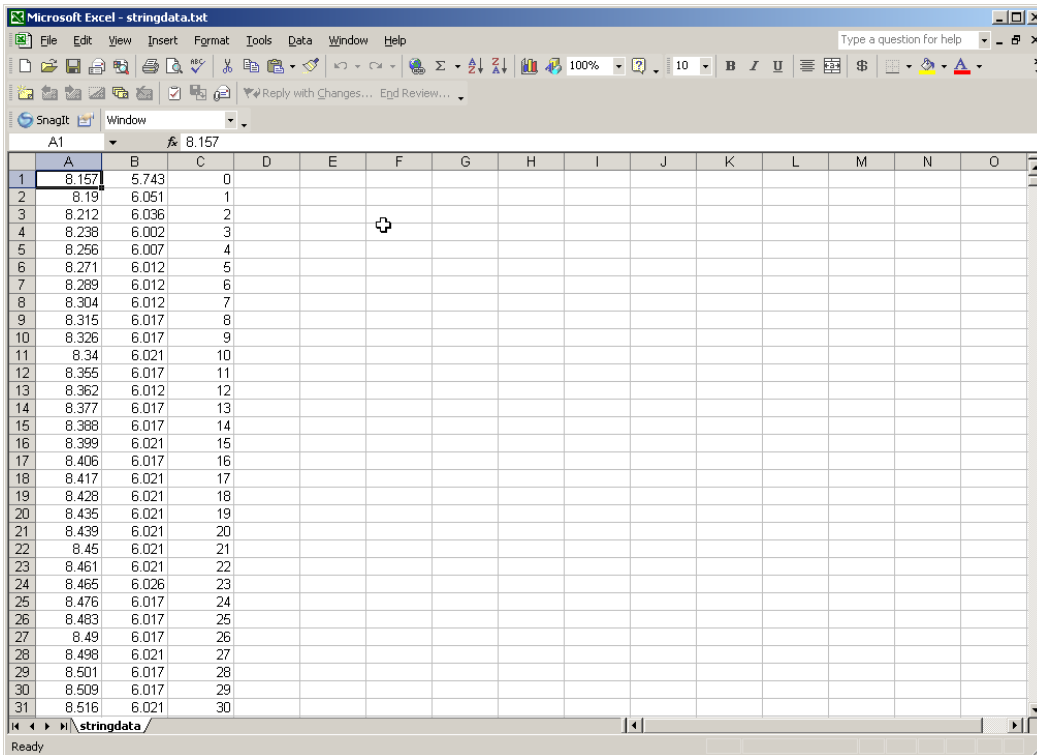

Voltage is what we're interested in here, so left-click the column header "A" with your mouse. It should then look like this:

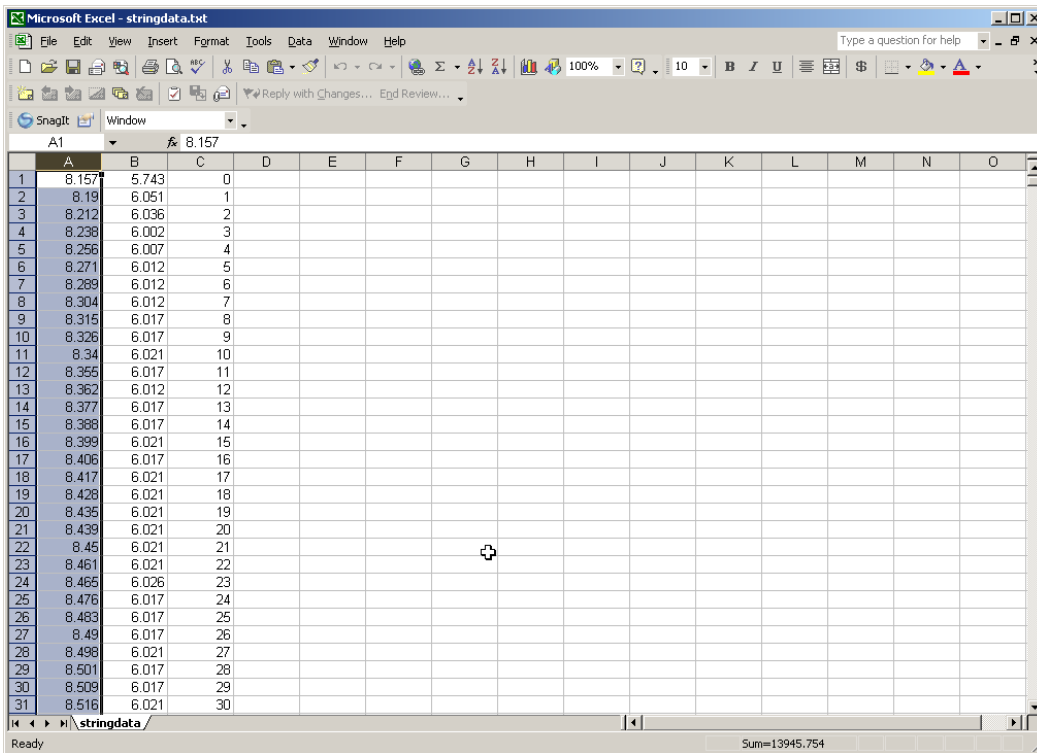

Now, click the graph icon on the top toolbar. 

This will activate the graphing wizard. A little time fiddling with this feature in Excel should yield a graph like this:

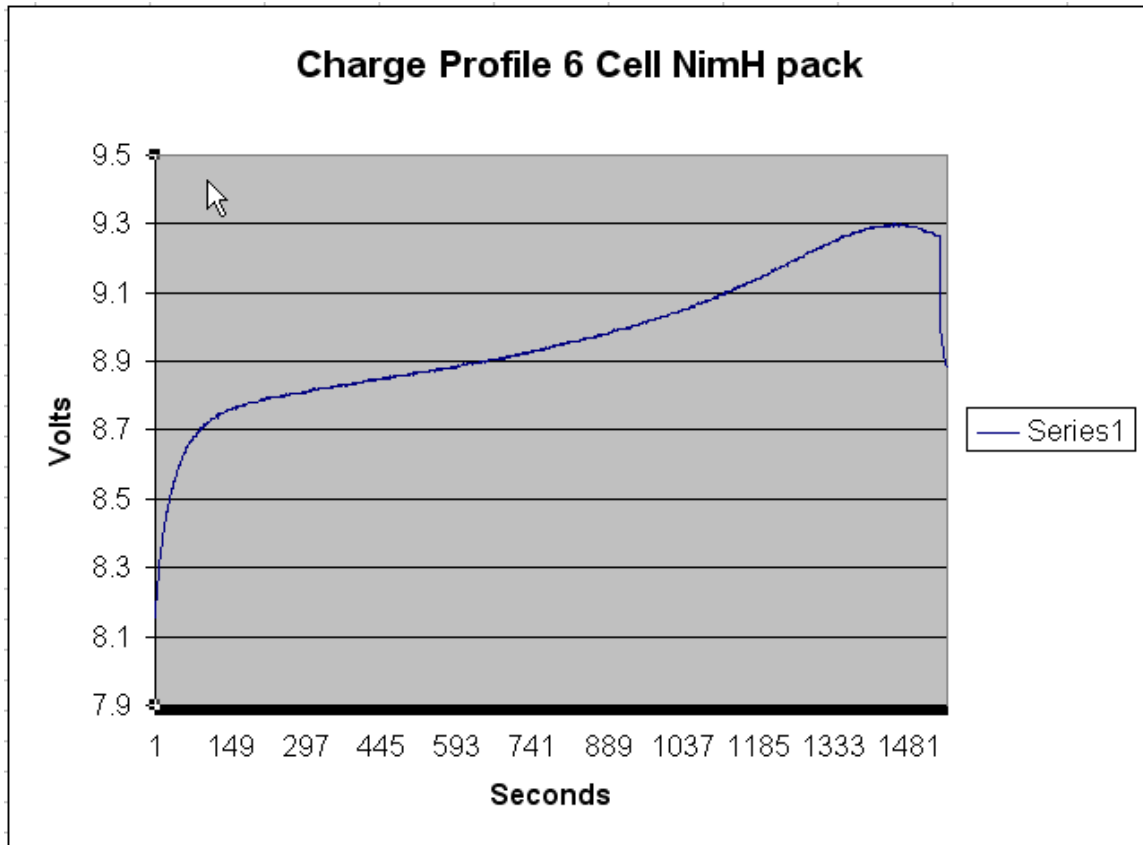

Excel has many other graph formatting options you can experiment with. There is also the possibility of overlaying multiple graphs, and actually performing scientific analysis on the collected data.

## Open Office

If you don't have the \$\$ to buy Excel, there is an open source suite of programs, similar to Microsoft® Office®, called Open Office®.

Open Office contains a spreadsheet application which can do virtually everything Excel can do, and it is 100% free.

It is beyond the scope of this manual to guide you through the use of Open Office; you'll have to do that yourself, but Open Office can be found here:

<http://www.openoffice.org/>

Have fun!

## Specifications

Operating Temperature Range (non-condensing)	32° F - 100° F
Power Supply Input Range	12 VDC – 16 VDC
NimH/NiCd Charge Current Setpoint Range	0.1 A – 12.0 A
Charge Current Setpoint Resolution	Below 2 A-- 0.1 A; Above 2 A – 0.5 A
LiPo Charge Current mAhr Setpoint Range	500 to 12000 mAhr
LiPo Charge Current mAhr Setpoint Resolution	50 mAhr
Max Charge Start Delay	999 minutes
LiPo Max Charge Seconds	100 Sec to 7200 Sec
LiPo Max Charge Seconds Resolution	100 Secs
LiPo Cell Count	1 Cell to 3 Cells
NimH/NiCd Discharge Current Setpoint Range	0.5 A – 35.0 A
NimH/NiCd Discharge Current Setpoint Resolution	Below 5 A – 0.1 A; Above 5 A – 1 A
LiPo Discharge Current Setpoint Range	0.5 A – 35.0 A
LiPo Discharge Current Setpoint Resolution	Below 5 A – 0.1 A; Above 5 A – 1 A
LiPo Cell Count	1 Cell to 3 Cells
Motor Current Range	Up to 20 A
Motor Voltage Setpoint Range	0.5 V – 8.0 V
Cooldown Delay Between Cycles	0 minutes - 180 minutes
Max Delay Between Peak Detects 1 and 2	0 seconds – 999 seconds
Trickle Charge Rate	100 mA (0.1 A)
Peak Detect Voltage Setpoint Range	0.01 V – 0.19 V
Auto Repeak	Yes; up to 2
Built-in Peak Detect Lockout Time	1 minute
Long Lockout Peak Detect Time (optional)	10 minutes
Cell Count	1 to 8 Cells
Voltage Measurement Resolution	Below 2 V - 1 mV; Above 2V – 10 mV
Current Measurement Resolution	100 mA
Maximum # of Stored Voltage Points for Charge Profile	500
Maximum # of Stored Voltage Points for Discharge Profile	500
# of Setups	10

### **Power Supply Requirements**

The power supply chosen for use with the T35-GFX should possess the following specifications:

Voltage Output	12 VDC – 16 VDC
Current	20 A DC

The current requirement is controlled by the maximum rate you intend to charge your packs at, and the maximum current delivered to your motors while using the motor run feature. If you normally use lower settings, you can get away with a lower current power supply, perhaps as low as 7 or 8 amps.



CEI does sell a small footprint power supply for use with the T35-GFX.

See our website

<http://www.competitionelectronics.com/>

for details.

Some supplies have a feature called foldback current limiting. This form of current limiting reduces the voltage output current of the supply drastically when overloaded, but then locks the voltage at some low level until the load is removed. This is generally undesirable, but you can use foldback limited power supplies as long as you are aware of the issue and don't exceed the power supply's foldback current limit rating.

## **When it Doesn't Work**

In spite of our best efforts, sometimes a T35-GFX malfunctions in the field. If this happens to you, we'll do our best to get you up and running again as quickly and conveniently as possible. Check the following sections for help solving your T35-GFX problem.

### ***Common Problems and Questions***

#### **Nonvolatile memory corruption**

This is uncommon, but possible. If you notice that the stored parameters have funny or nonsensical values, or if your T35-GFX acts strangely in any way, it won't hurt to try restoring the nonvolatile memory to factory defaults. See "Reinitializing non-volatile memory", earlier in the manual, for details on how to do this.

#### **Failure to power up correctly; garbled display**

Due to the fact that power is connected to the T35-GFX through alligator clips or connectors, sometimes the T35-GFX will fail to power up correctly and the display will be garbled and the T35-GFX will not function correctly. Disconnecting and then carefully reconnecting the clips with a deliberate, non-jerky motion will result in a normal power up sequence and normal operation.

## Fuses



**Figure 24: 20 amp fuses**

Sooner or later, you'll blow one or more fuses on your T35-GFX, so go to the local auto parts store and buy some extras now.

The two forward located fuses protect the charge and discharge power circuitry. The rearmost fuse protects the power supply input circuit. All are rated at 20 A.

If you blow one of the forward fuses, change both, because they are connected in parallel and it is most likely that if one blows, the other has been stressed and will blow shortly. The fuses share current and so they both have to be in good shape in order to achieve the full 40 A rating without blowing.

Normally, if you hook up the power leads backwards, the rearward fuse will blow immediately, UNLESS your power supply goes into current limiting, or cannot deliver enough current to blow the fuses. If this is the case, you will almost certainly see smoke coming from your T35-GFX! Although this means a repair, it does not usually cause extensive damage.

Beware of cheap fuses. They can overheat and cause fire. Use good quality, name brand fuses such as Bussman or Littelfuse.

### **Voltage Drop, Resistance, and the Proper Use of Sense Leads**

When using the T35-GFX, during charge or discharge, always be sure to connect the small sense leads as close as physically possible to the pack connectors. For NiCd/NimH packs, avoid clipping them to the larger, power-carrying alligator clips, and don't cut the clips off and solder them into the alligator clips. LiPo packs often have shrouded connectors and a separate sense lead connection to the terminals can be impossible, so in this case you must solder the sense leads directly into the main connectors, as illustrated below. The LiPo packs have superior, lower resistance connectors and there will be less voltage drop than what is experienced with alligator clips. Use sense leads for all LiPo operations.

## **Should I send my T35-GFX in for Calibration?**

The T35-GFX is one of the most accurate and stable charger/dischargers CEI has ever made. It would be highly unlikely that recalibration would be necessary. If you suspect your T35-GFX is out of calibration, call us and we'll talk about it; there may be other factors affecting your readings. If necessary, we can easily recalibrate the unit.

## ***Sending your T35-GFX in for Repair***

The usual turn around time for repairs is 5 working days, beginning on the day we receive the unit. Total charges will include parts cost, labor, and return shipping.

It is best to contact us before you ship us your unit because we can help you make sure that there really is a problem requiring service. Also, the method of payment can be established at this time, and you will help us to serve you more efficiently by minimizing irritating delays.

The preferred method of payment is Visa or MasterCard. Include your card type (Visa or MasterCard only), and the card account number, your name as it appears on the card, and the card's expiration date. If you would prefer to pay by UPS COD, make sure to provide a daytime phone number so that we can call you with the exact cost. You will need to obtain a cashiers check or money order in the correct amount.

When you return your T35-GFX, include the following:

- Your name
- A return address
- A daytime phone number
- An explanation of the problem.

For warranty repair, also include:

- A copy of a dated receipt of purchase.

Please see the warranty information, printed later on in this manual, for specific warranty details.

## ***Firmware Updates***

At the heart of the T35-GFX is a computer. It is a very small computer, but it is a computer, nonetheless. It takes software to make computers run, and the T35-GFX is no exception.

How the T35-GFX operates is a function of both hardware (electronic circuitry) and software. For this reason, changes to the design or performance enhancements made to the T35-GFX cannot always be incorporated into preexisting machines.

However, there are many feature additions and changes that are exclusively a result of software. These things can often be added to existing T35-GFX units with only a short reprogramming process.

To find out if your machine can be upgraded, observe the "firmware revision" number that appears on the display, and then call Competition Electronics, Inc. to see if there is an upgrade that can be installed in your T35-GFX. CEI can do this for you for a small service charge.

### ***\*\*\*Limited Warranty\*\*\****

COMPETITION ELECTRONICS, INC., warrants the product manufactured by it to be free from defects in material and workmanship for a period of 90 days from date of purchase by the original purchaser for use. COMPETITION ELECTRONICS, at it's option, will repair or replace without charge, or refund the purchase price of, any product which fails during the warranty period by reason of defect in material or workmanship found upon examination by COMPETITION ELECTRONICS, INC., to have been the cause of failure. This

warranty does not cover any failures attributable to abuse, mishandling, failure to follow operating instructions, alteration or accident.

To make claim under this warranty, the purchaser must return the product to COMPETITION ELECTRONICS, INC. at the address shown below, properly packed and with shipping charges prepaid. All claims must be accompanied by a sales slip or other written proof of date of purchase.

TO THE EXTENT PERMITTED BY LAW, ANY AND ALL IMPLIED WARRANTIES, INCLUDING MERCHANTABILITY AND FITNESS FOR A PARTICULAR PURPOSE, ARE EXCLUDED; ANY IMPLIED WARRANTIES NOT EXCLUDED ARE LIMITED IN DURATION TO 90 DAYS FROM DATE OF PURCHASE. INCIDENTAL AND CONSEQUENTIAL DAMAGES ARE EXPRESSLY EXCLUDED FROM THE REMEDIES AVAILABLE TO PURCHASER, AND THE REMEDIES PROVIDED BY THIS WARRANTY SHALL BE EXCLUSIVE TO THE EXTENT PERMITTED BY LAW.

(Note: Some states do not allow limitations on how long the implied warranty lasts or the exclusion or limitation of incidental or consequential damages, so the foregoing limitations and exclusions may not apply to you. This warranty gives you specific legal rights, and you may also have other rights which vary from state to state.)

If any product returned by the purchaser is found by COMPETITION ELECTRONICS, INC., to require service not covered by warranty, COMPETITION ELECTRONICS, INC., will recondition to working order any product returned to it regardless of condition upon purchaser's remittance of payment of ½ current retail price, if it is still manufactured by COMPETITION ELECTRONICS, INC.

### ***How to Contact Competition Electronics***

Competition Electronics, Inc.  
3469 Precision Dr.  
Rockford, IL 61109  
PH 815-874-8001  
FAX 815-874-8181  
[www.competitionelectronics.com](http://www.competitionelectronics.com)

This manual and its contents ©1996-2007 Competition Electronics, Inc.