

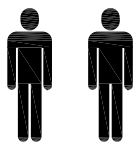

Sunshine™ Cotbed

Assembly Instructions
(BUE-SCB)



IMPORTANT:
THE ASSEMBLY OF THIS PRODUCT
REQUIRES TWO PEOPLE

IMPORTANT:
PLEASE READ THE INSTRUCTIONS CAREFULLY AND KEEP FOR FUTURE REFERENCE

Read all instructions BEFORE assembly and USE of the product. KEEP INSTRUCTIONS FOR FUTURE USE.

IMPORTANT, RETAIN FOR FUTURE REFERENCE PLEASE READ CAREFULLY

Boori Australia Pty Ltd
18-20 Charles Street
St.Marys Sydney NSW
2760 Australia
Ph: (61 2) 9833 3769
Fax: (61 2) 9673 4240
www.boori.com.au

Boori (UK) Ltd
Unit 1,Transigo
Gables Way
Thatcham, RG19 4ZA
Ph: (44) 016 3529 5670
Fax: (44) 016 3587 7552
www.boori.co.uk

Boori USA LLC
20 Chapin Road, Suite 1001
Po Box 406
Pine Brook, NJ 07058
Ph: +1 973 577 6933
Fax: +1 973 577 6934
www.boori.com

ブーリジャパン株式会社
〒541-0057大阪市中央区北久宝寺町
4丁目2-10
Tel: 06-4963-3939
Fax: 06-4963-3900
www.boori.jp

Instructions for Boori Urbane Sunshine™ Cotbed (BUE-SCB)

Hardware and Parts List

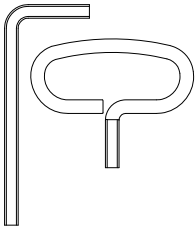
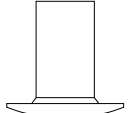
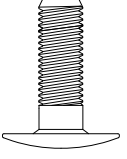
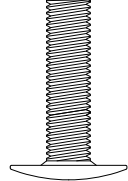
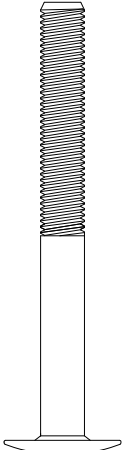
2 x Allen Keys	4 X 14mm Capping nuts	4 X 18mm Connecting bolts	4 X 23mm Connecting bolts	12 X 60mm Connecting bolts
	A 	B 	C 	D 
	Actual size	Actual size	Actual size	Actual size

NOTE: Use only spare parts approved by the manufacturer.

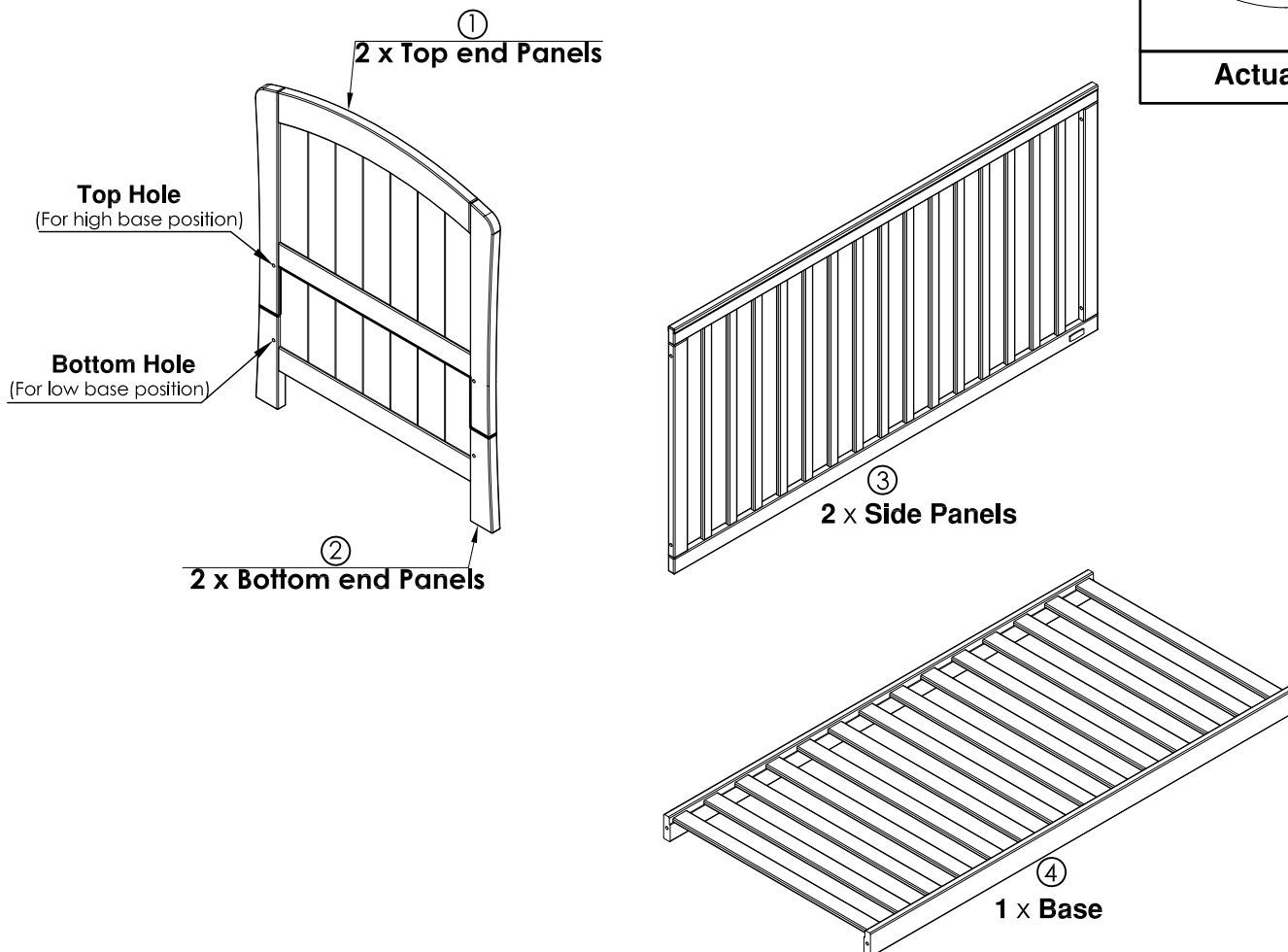

ASSEMBLY AS A CRIB

Step 1: Connect the **End panels** to the base^④ with the **4 x D** connecting bolts provided. Block remaining holes on **End Panels** with **4 x A** capping nuts and **4 x C** connecting bolts provided. Do not tighten at this stage.

Note: Top Hole for newborn
Bottom Hole for baby

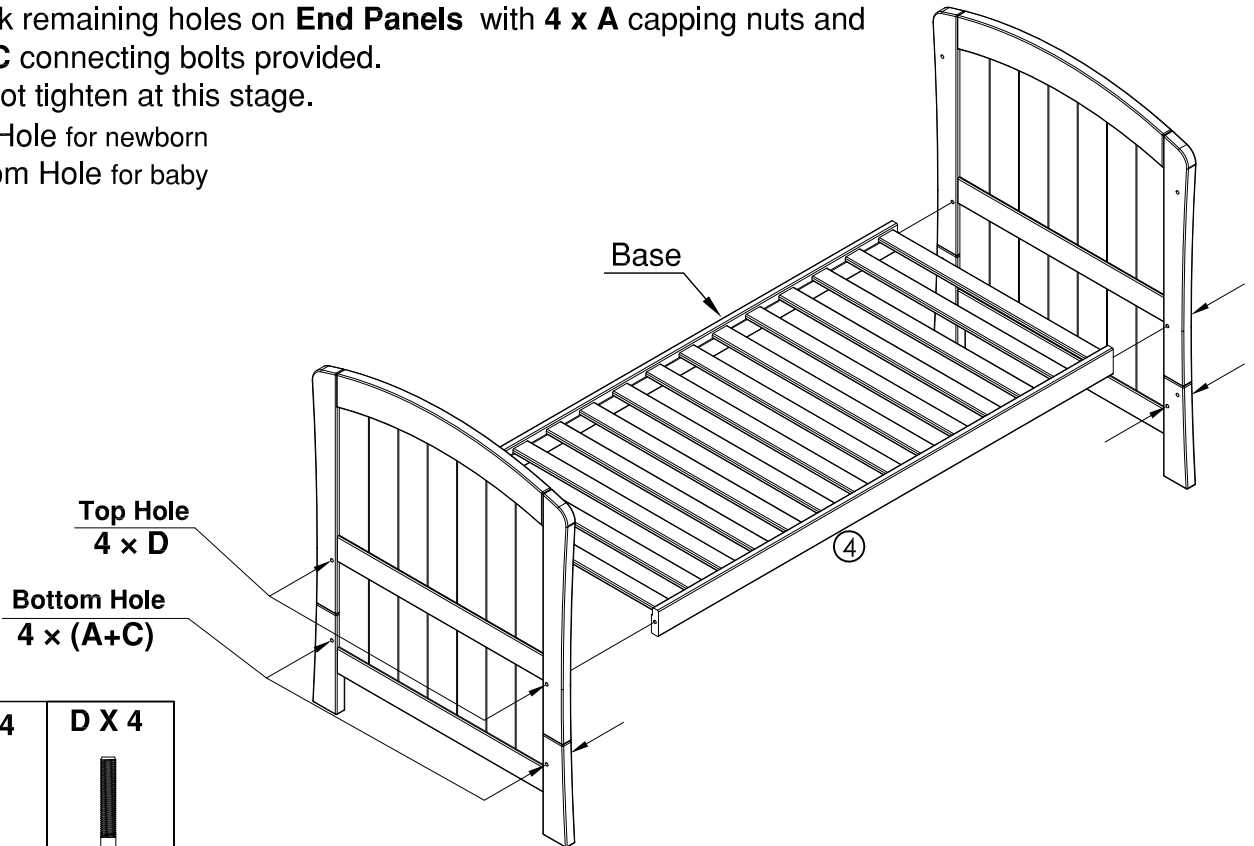

A X 4



C X 4

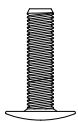

D X 4



Step 2: Connect 2 x Side Panels^③ to the two **End panels** with the **8 x D** connecting bolts provided. Tighten all the connecting bolts to secure but do not over tighten.

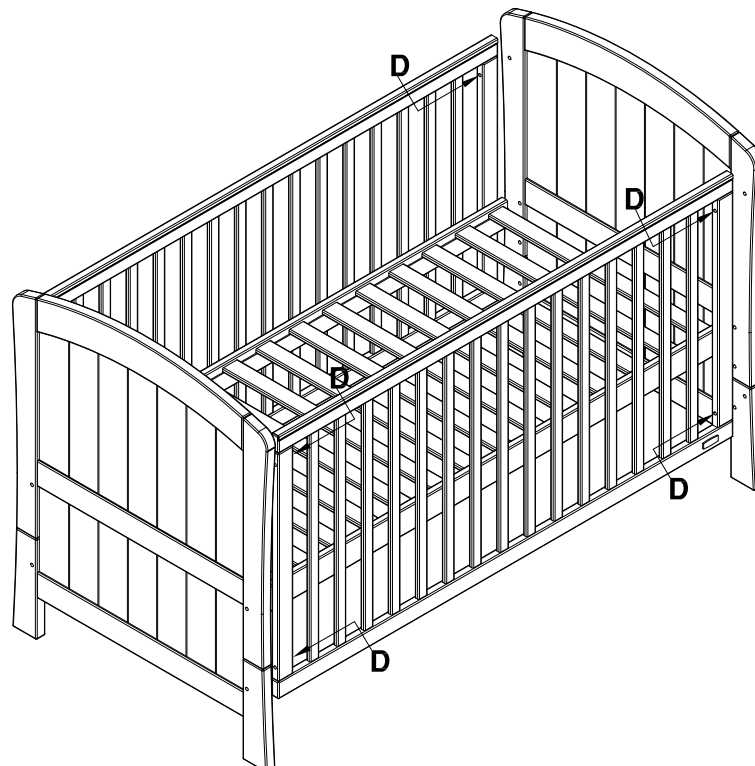

D X 8



ASSEMBLY AS A CRIB

Note: When child is able to sit up, adjust **Base**⑤ to the **Bottom Hole** low base position (for baby).

1. **Remove** bumper pads, large toys and other objects that could serve as steps for climbing out.
2. **Release 8 x D** connecting bolts on **Side Panels**③, (see Step 2 for **D** connecting bolt location).
Remove 4 x D connecting bolts from **top Holes** of **Side Panels**①.
3. **Remove 4 x A** capping nuts and **4 x C** connecting bolts from **Bottom Holes** of **End Panels**② and use to block **Top Holes** of **End Panels**①.
4. Connect **Base**④ to **Bottom end Panels**② using **4 x D** connecting bolts to secure **Bottom Hole** lower base position.
5. **Tighten all remaining bolts .**

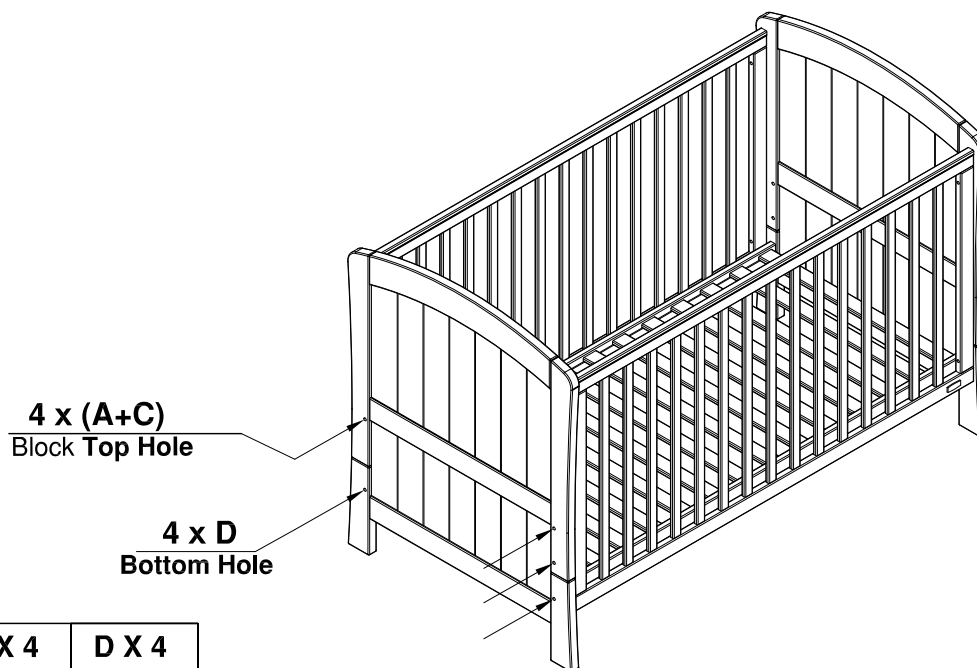
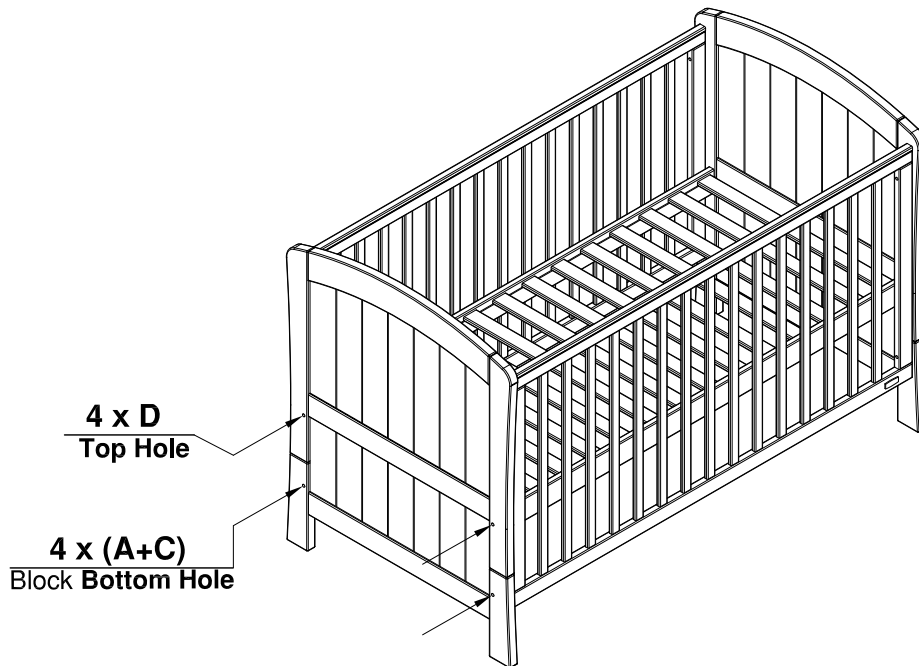

A X 4



C X 4

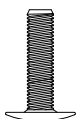

D X 4



CONVERTING YOUR CRIB TO A TODDLER BED

Step 1: Connect the **Top End panels** ① with the **4 x D** connecting bolts provided.

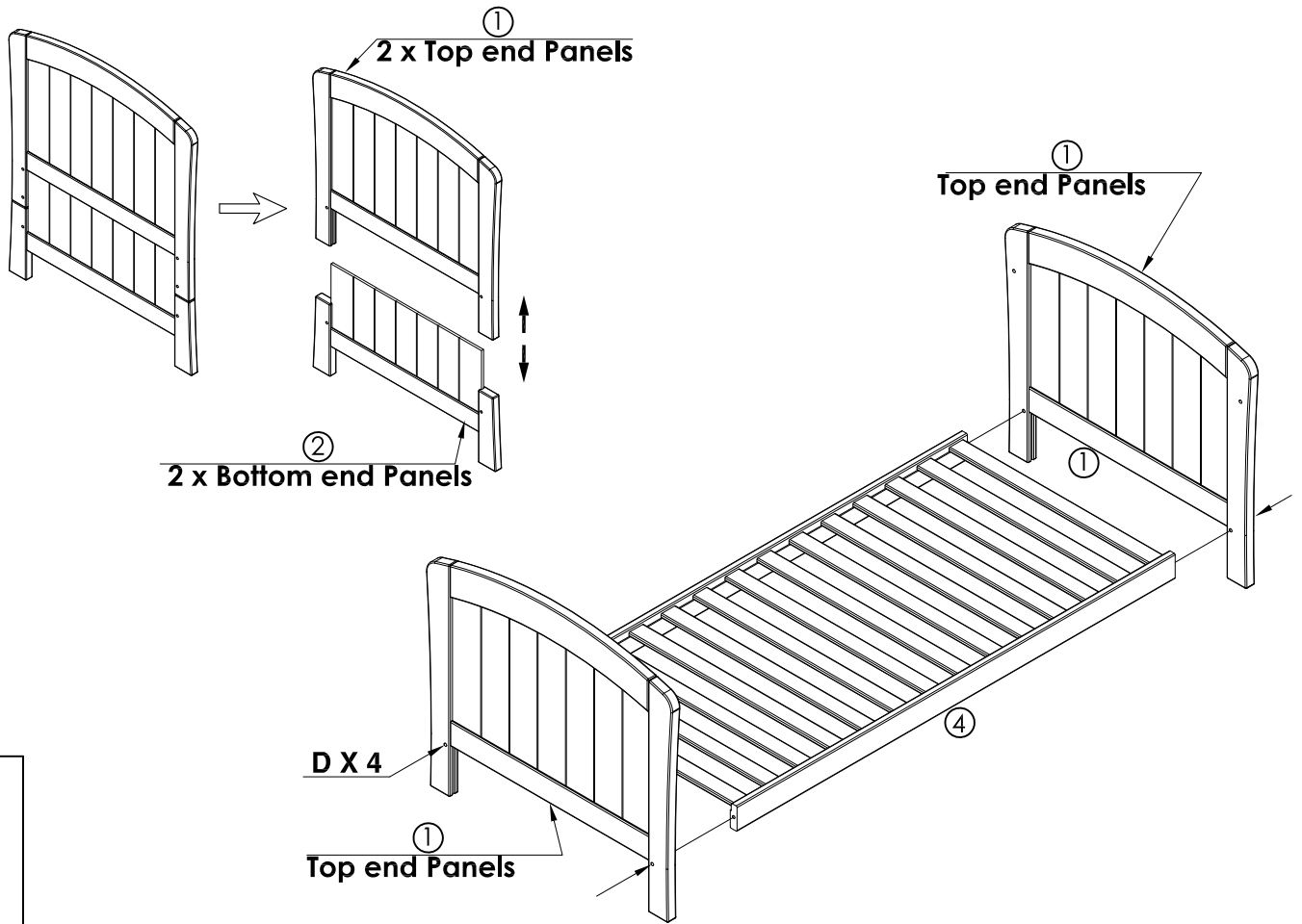

Step 2: Block remaining holes on the **Top End panels** ① with **4 x B** connecting bolts provided.

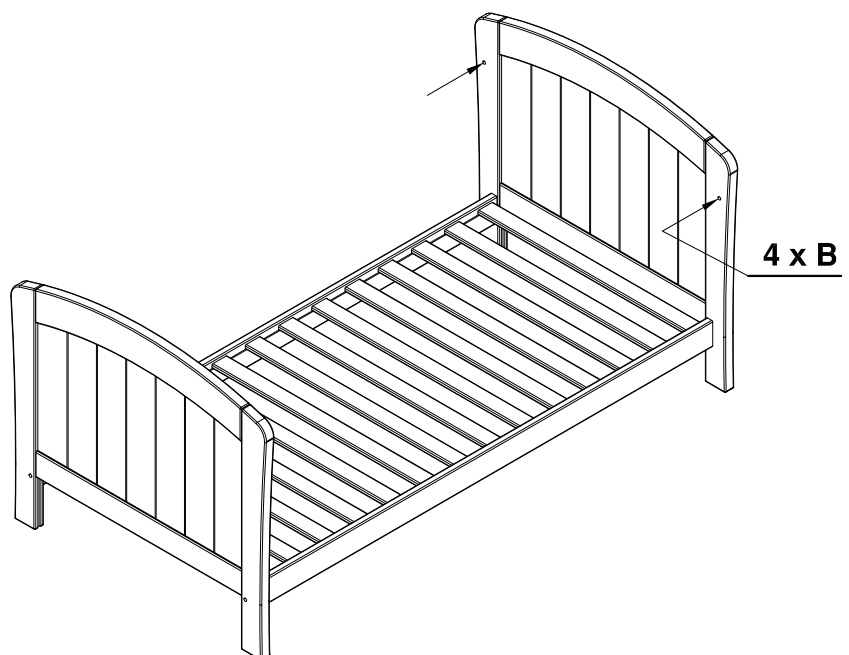

B X 4

