

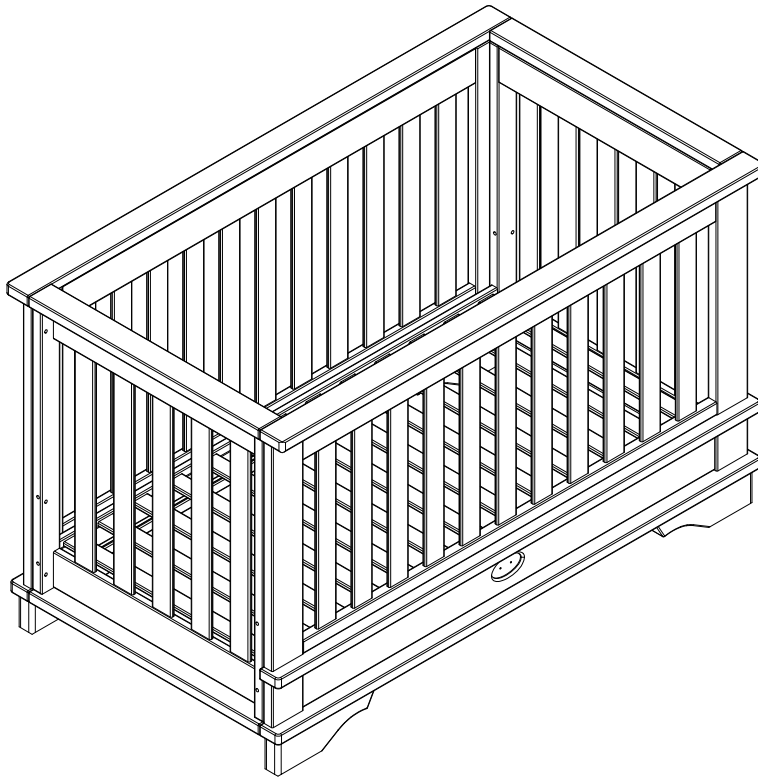

Eton Convertible Plus™ Crib

Assembly Instructions

(BCA-ETCP)



IMPORTANT:
THE ASSEMBLY OF THIS PRODUCT
REQUIRES TWO PEOPLE

IMPORTANT:
PLEASE READ THE INSTRUCTIONS CAREFULLY AND KEEP FOR FUTURE REFERENCE

Read all instructions BEFORE assembly and USE of product. KEEP INSTRUCTIONS FOR FUTURE USE

IMPORTANT, RETAIN FOR FUTURE REFERENCE
PLEASE READ CAREFULLY

Boori Australia Pty Ltd
 18-20 Charles Street
 St.Marys Sydney NSW
 2760 Australia
 Ph: (61 2) 9833 3769
 Fax: (61 2) 9673 4240
 www.boori.com.au



Boori (UK) Ltd
 Unit 1, Transigo
 Gables Way
 Thatcham, RG19 4ZA
 Ph: (44) 016 3529 5670
 Fax: (44) 016 3587 7552
 www.boori.co.uk

Boori USA LLC
 20 Chapin Road, Suite 1001
 Po Box 406
 Pine Brook, NJ 07058
 Ph: +1 973 577 6933
 Fax: +1 973 577 6934
 www.boori.com

ブーリジャパン株式会社
 〒541-0057 大阪市中央区北久宝寺町
 4丁目2-10
 Tel: 06-4963-3939
 Fax: 06-4963-3900
 www.boori.jp

Instructions for Boori Country Eton Convertible Plus Crib (BCA-ETCP)

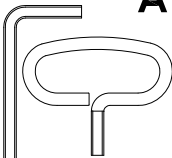
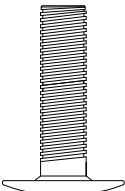
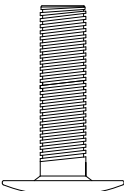
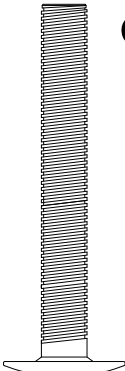
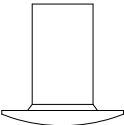
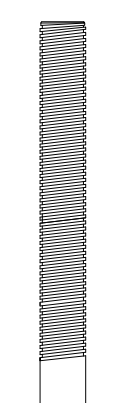
Hardware and parts list

2 x Allen Keys	4 x M6 x 23mm Connecting bolts	8 x M6 x 23mm Connecting bolts	12 x M6 x 47mm Connecting bolts	12 x M6 x 14mm Capping nuts	4 x M6 x 54mm Connecting bolts	8 x M6 x 90mm Connecting bolts
	 Actual size	 Actual size	 Actual size		 Actual size	 Actual size
	⚠ For a full bed					

NOTE: Use only spare parts approved by the manufacturer

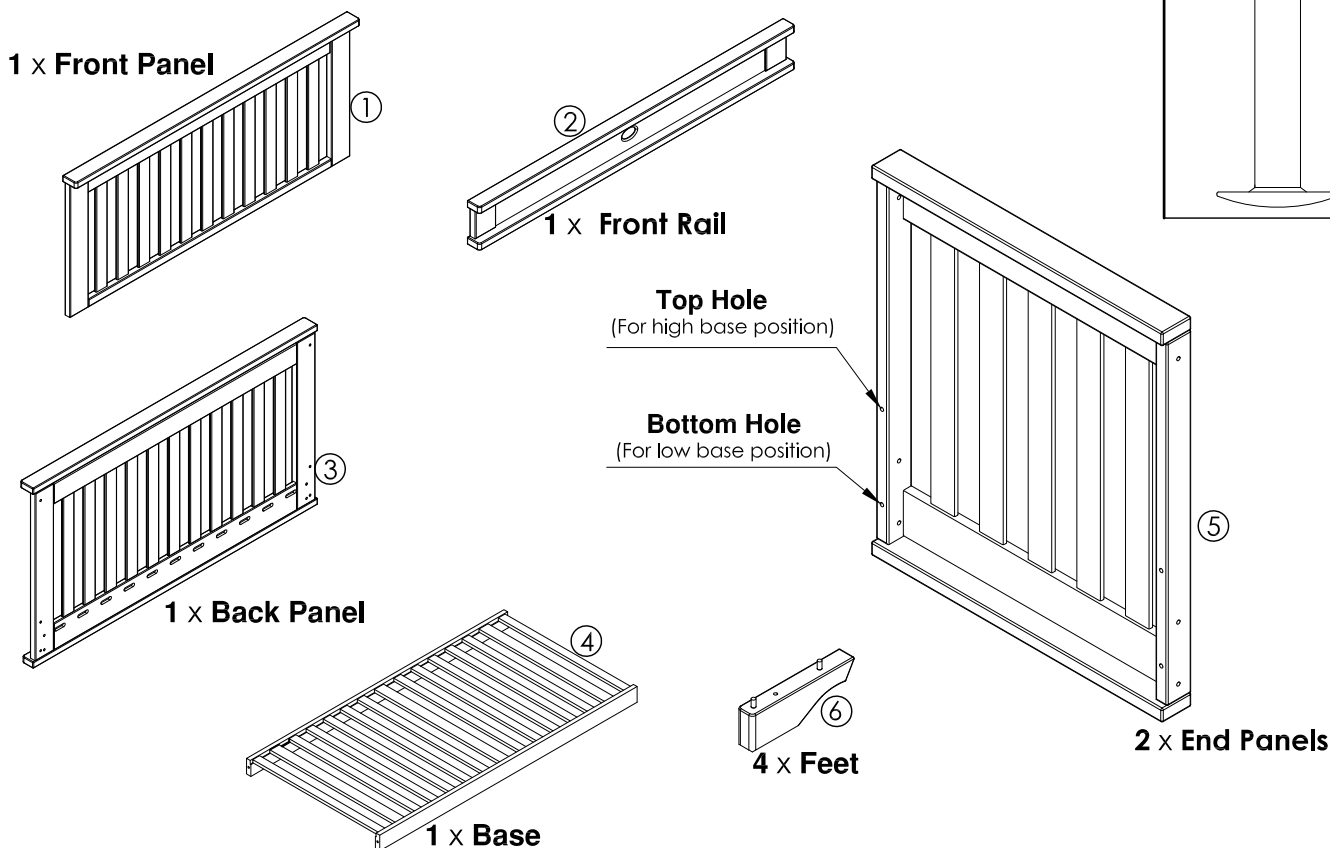

ASSEMBLY AS A CRIB

Step 1: Connect 2 x **End Panels** (5) to the **Base** (4) with the **4 x F** connecting bolts provided.

Note: **Top Hole** high base position is for newborn.

Bottom Hole low base position is for baby.

⚠ Adjust to **Bottom Hole** low base position before child is able to sit up.

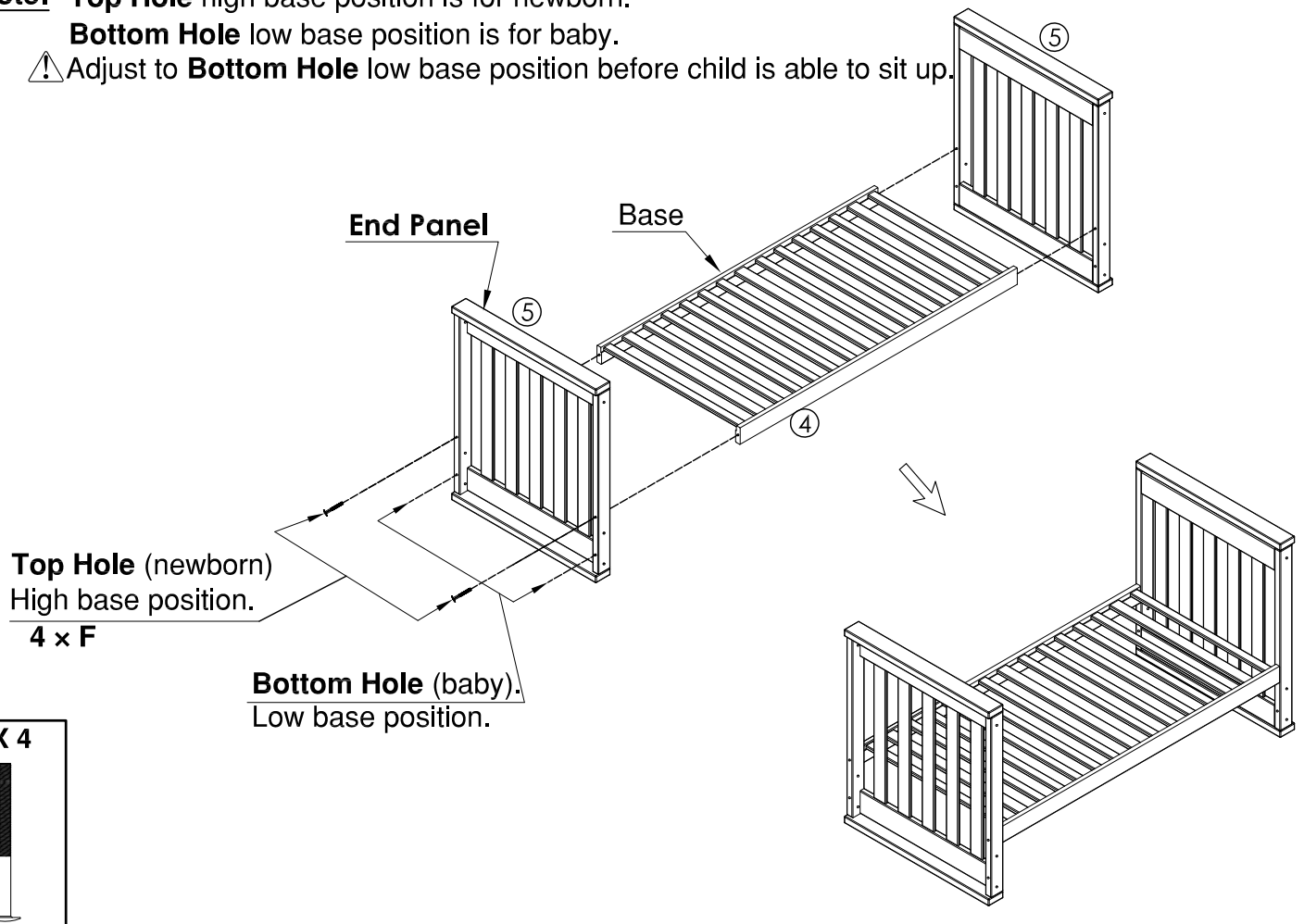

Step 2: Connect **Back Panel** (3) with the **6 x C** connecting bolts provided.

Connect **Back Panel** to the two **End Panels** with the **6 x C** connecting bolts provided.

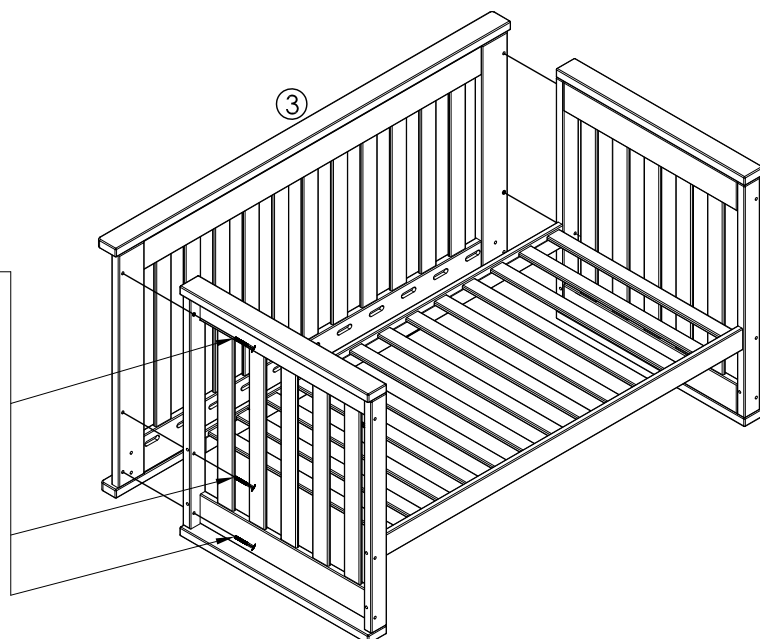

C X 6

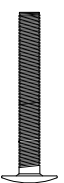

ASSEMBLY AS A CRIB

Step 3: Connect **Front Rail** ② and **Front Panel** ① to the two **End Panels** ⑤ with the **6 x C** connecting bolts provided.
Tighten all the connecting bolts to secure but do not over tighten.

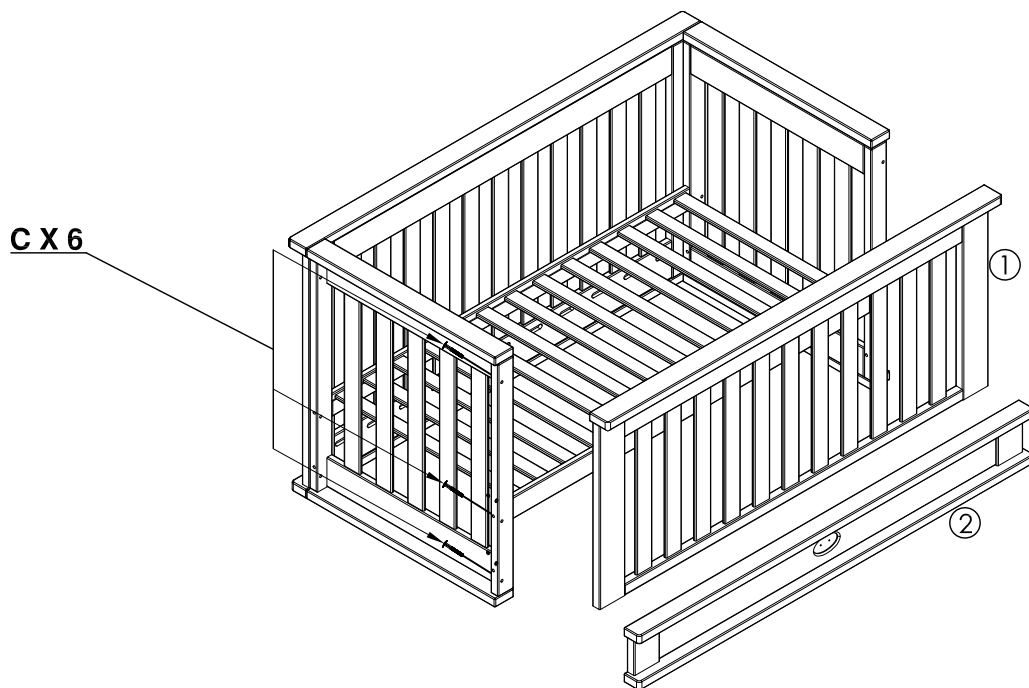

C X 6

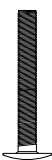

Step 4: Install **Feet** ⑥ as shown.

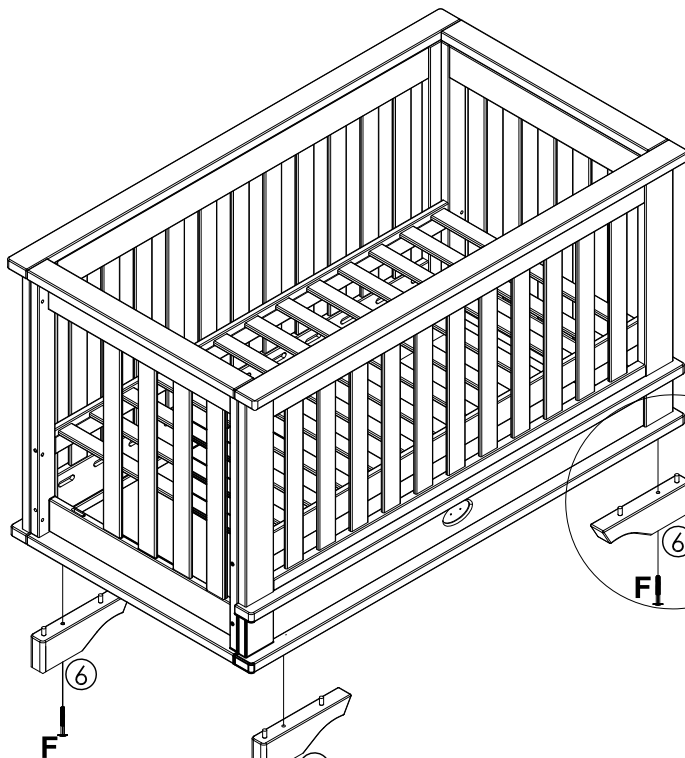

Must insert wood dowels into holes on the **Front Rail** and **Back Panel**

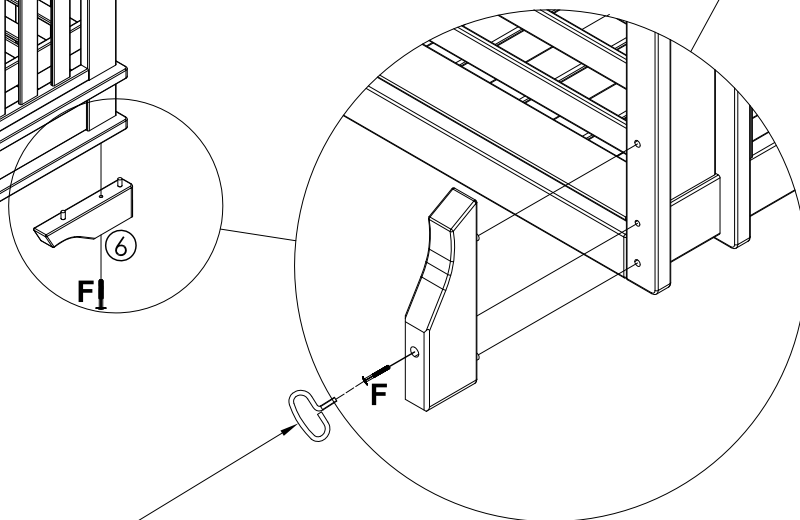

F X 4

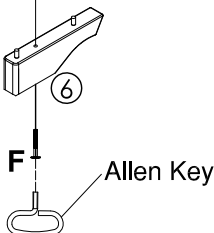

Connect **4 x Feet** ⑥ to the **Back Panel** ③ and **Front Rail** ② with the **4 X F** connecting bolts provided.

ASSEMBLY AS A CRIB

Step 5: Block remaining holes on **End Panels ⑤** with **4 x D** capping nuts and **4 x E** connecting bolts provided.

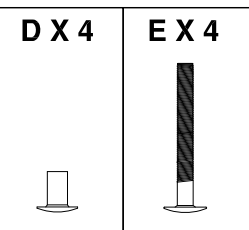

4 x (D+E)
Bottom Hole

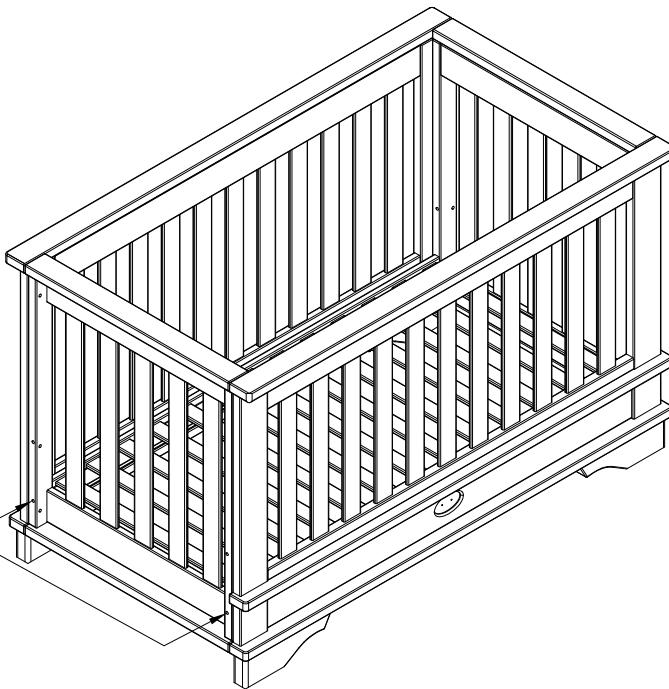

Note: When child is able to sit up, adjust **Base ④** to the **Bottom Hole** low base position (for baby).

1. **Remove** bumper pads, large toys and other objects that could serve as steps for climbing out.
2. **Loosen 6 x C** connecting bolts on **Front Panel, Back Panel and Front Rail**, (see Step 2-3 for **C** connecting bolt location). **Remove 4 x F** connecting bolts from **End Panels ⑤**.
3. **Remove 4 x D** capping nuts and **4 x E** connecting bolts from **Bottom Holes** of **End Panels ⑤** and use to block **Top Holes** of **End Panels ⑤**.
4. Connect **Base ④** to **End Panels ⑤** using **4 x F** connecting bolts to secure **Bottom Hole** lower base position.
5. **Tighten all remaining bolts**.

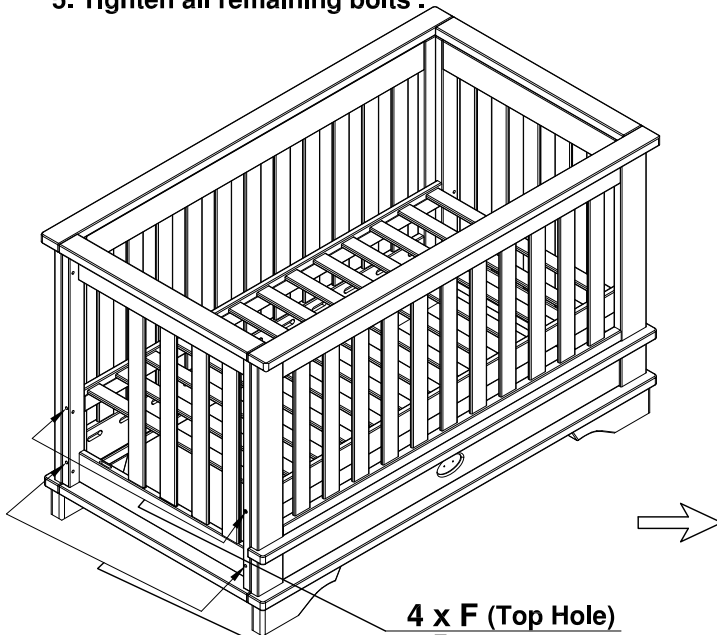

4 x F (Top Hole)
Remove

4 x (D+E) (Bottom Hole)
Remove

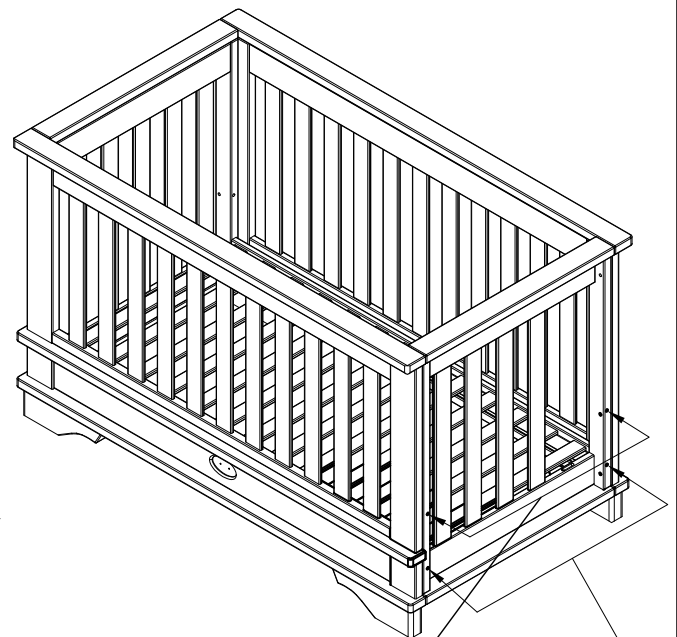

4 x (D+E)
Top Hole

4 x F
Bottom Hole

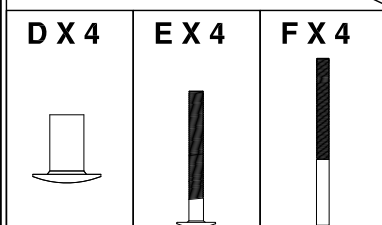

Tighten all remaining base bolts.

CONVERTING YOUR CRIB TO A TODDLER BED

Step 1: Remove 4 x C connecting bolts from the **Front Panel** ① to separate the **Front Panel** ① from the **End Panels** ⑤. Do not remove 2 x C connecting bolts which attach the **End Panels** ⑤ to the **Front Rail** ②.

Note: Keep the **Base** ④ in the low position .

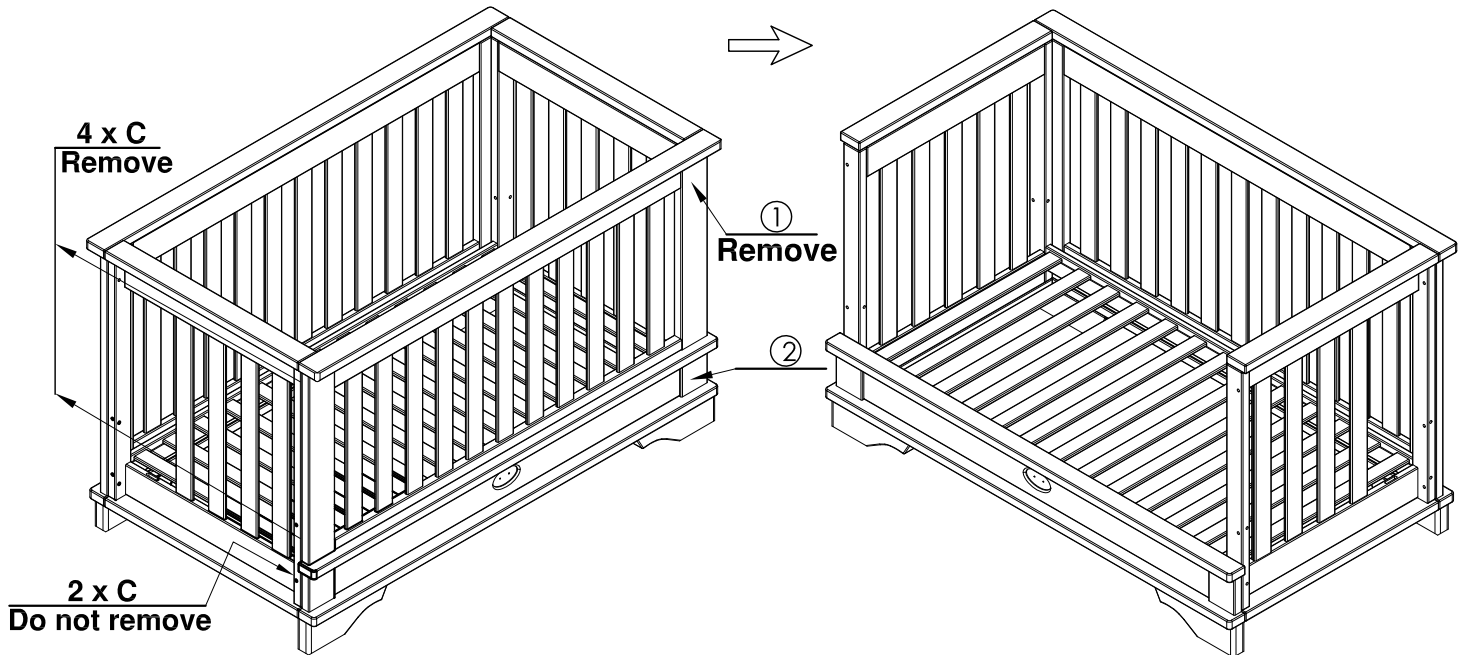

Step 2: Block remaining holes on **End Panels** ⑤ with 3 x D capping nuts and 3 x B connecting bolts provided.
For the Toddler Bed Conversion, item **CPTGR (Convertible Plus™ Toddler Guard Rail)** is included in matching finish.

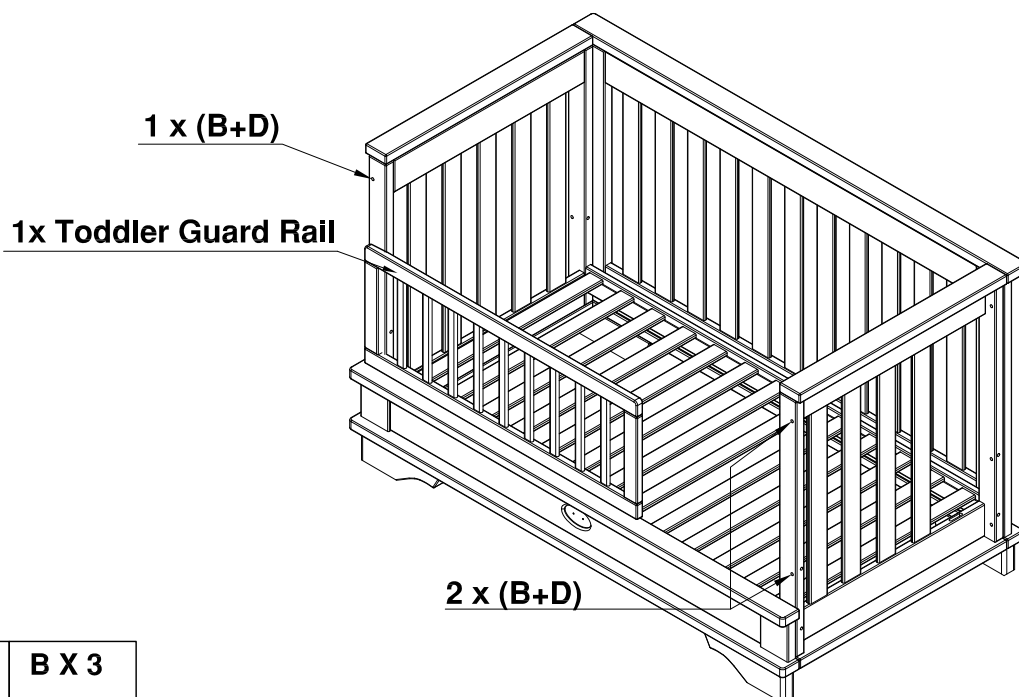

D X 3

B X 3



CONVERTING YOUR CRIB TO A LOVESEAT

Step 1: Reposition the **Base**④ to the **Top Hole** high base position of the **End Panels**⑤.
Remove **8 x E** connecting bolts from the **Front Rail**② and **Back Panel**③ to separate from the **End Panels**⑤.

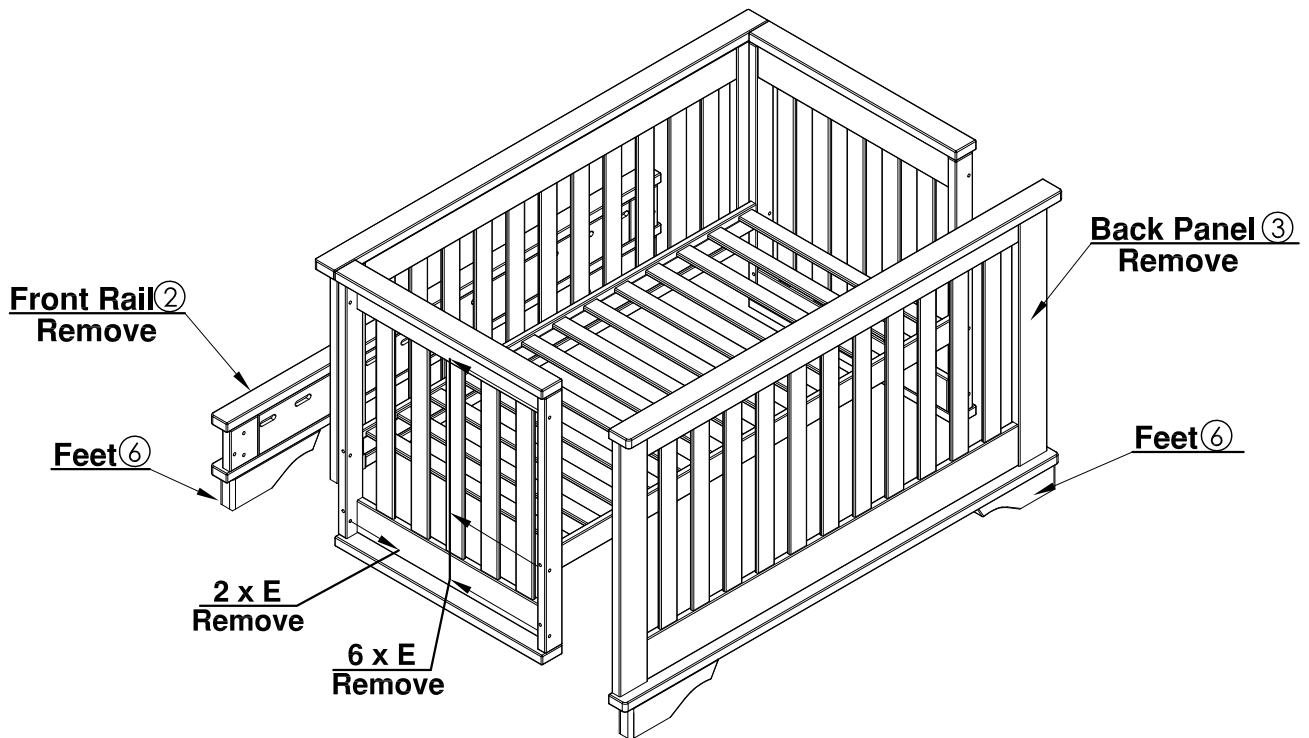

Step 2: As a result of removing the **Front Rail**② and **Back Panel**③, block remaining holes on the **End Panels**⑤ with **8 x (B+D)** capping nuts and connecting bolts provided.

Note: When **Base**④ is on the **Top Hole** high base position, **4 x (E+D)** capping nuts and connecting bolts provided are used to **block** the **Low Holes**.
Tighten all the connecting bolts.

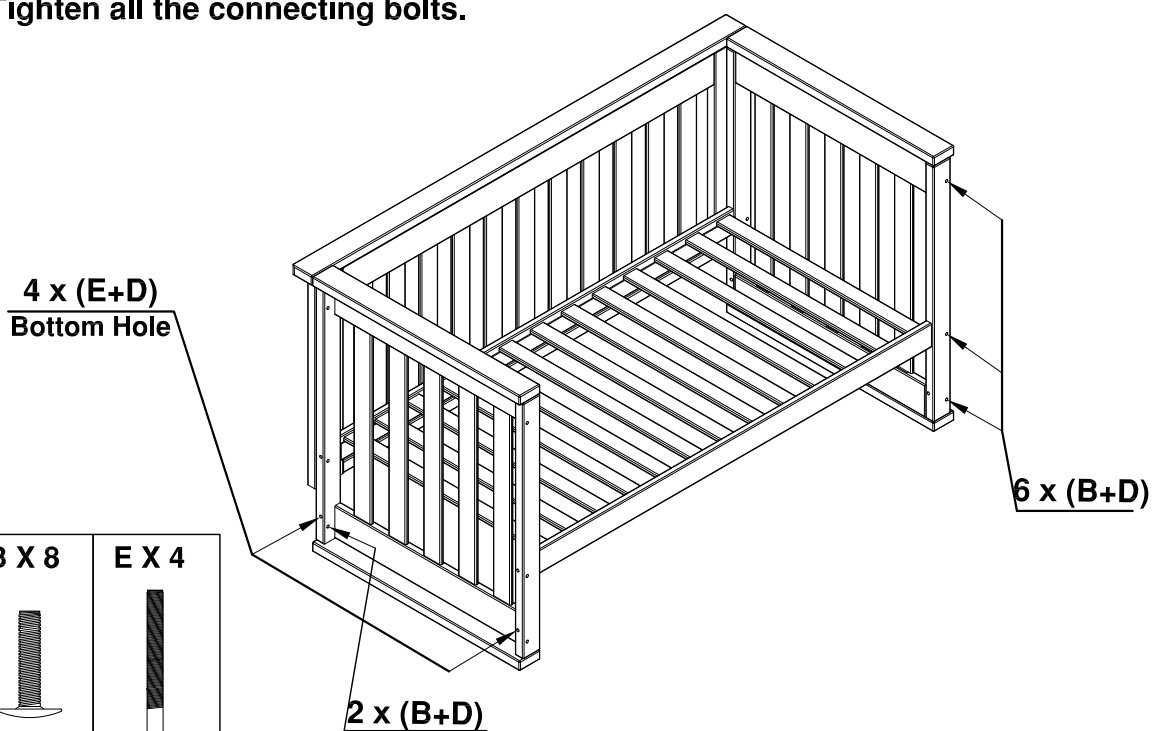

D X 12

B X 8

E X 4



2 x (B+D)

CONVERTING YOUR CRIB TO A FULL BED

Note: The Full Bed Conversion, item **BCA-CPK (Convertible Plus™ Full Bed Conversion Kit)** is sold separately and available in matching finish.

Please contact your Boori dealer for more information.

Note: Block remaining holes on **Back Panel ③** with **4 x B** connecting bolts provided.

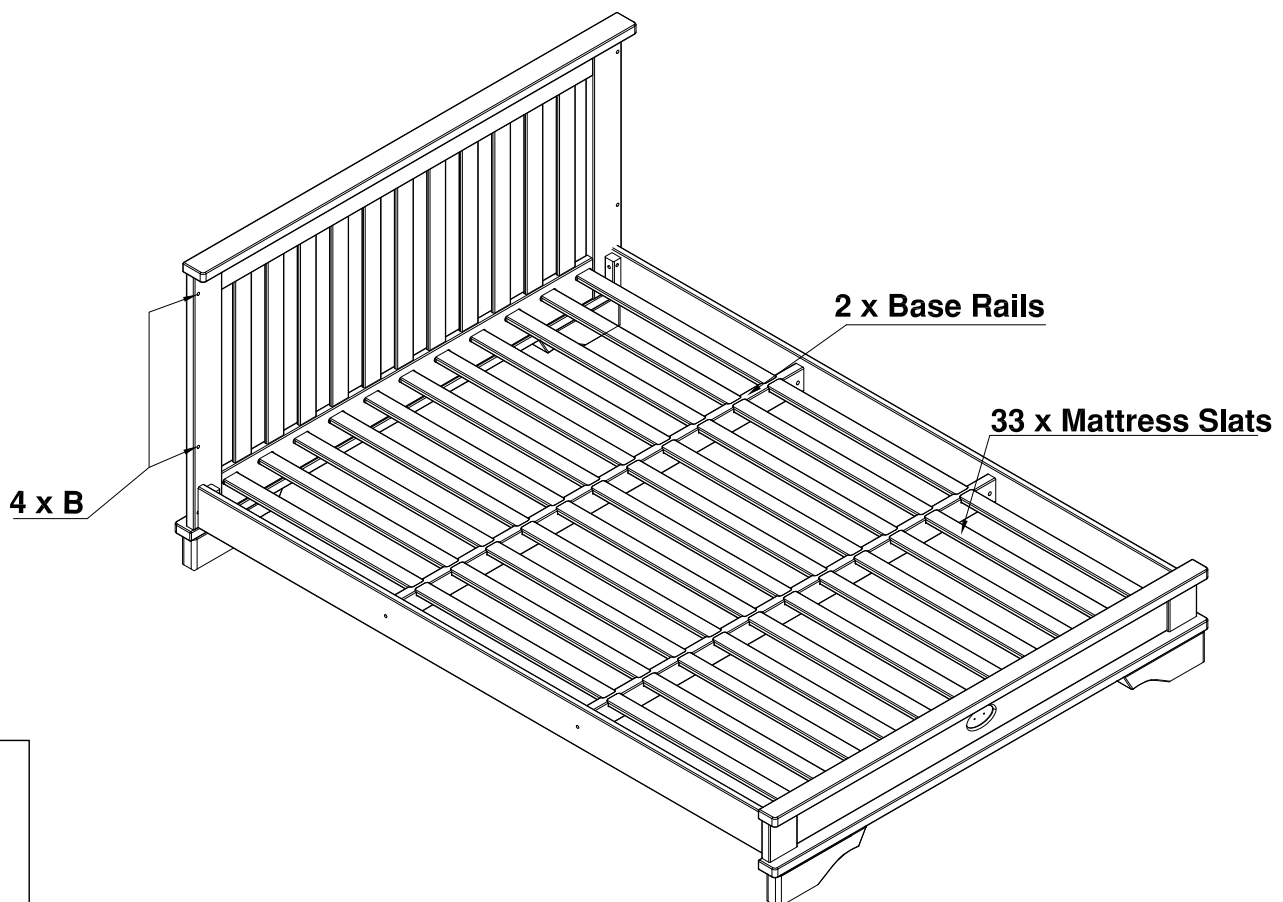
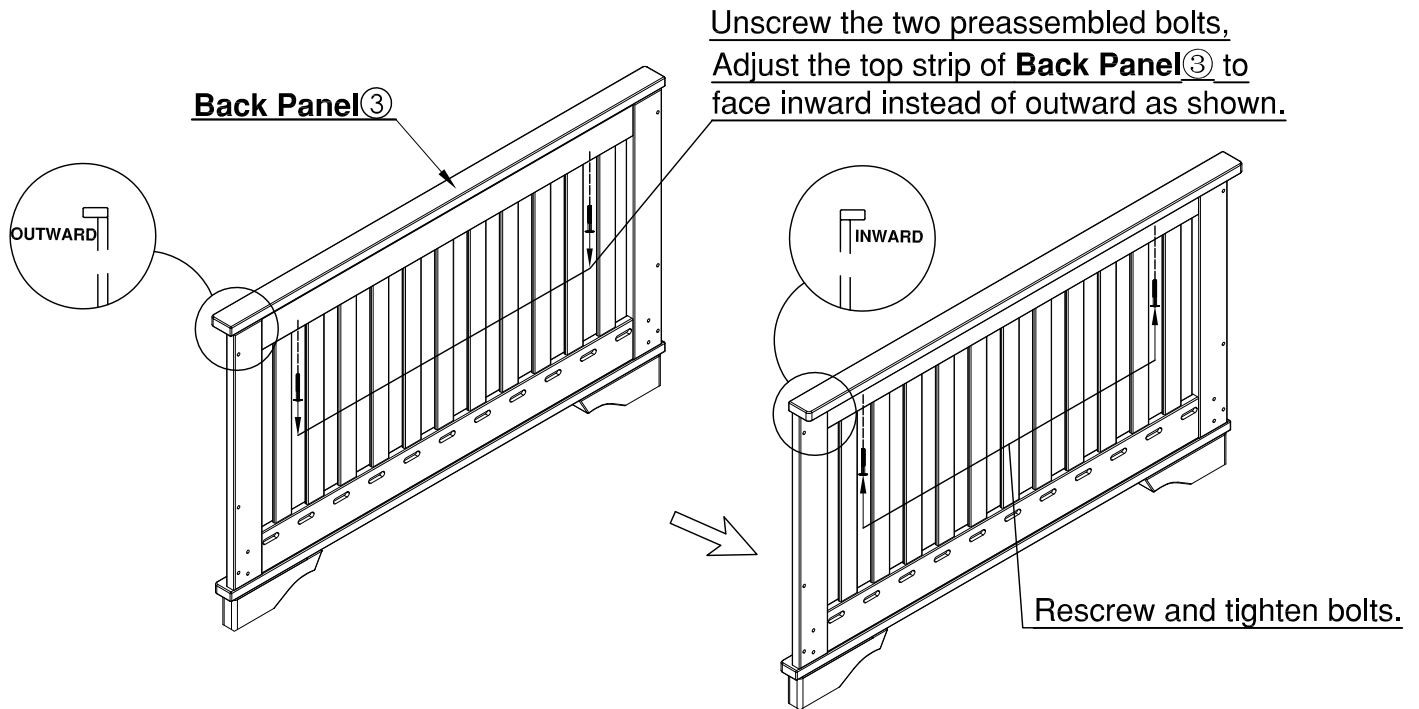

B X 4

