

**\*IMPORTANT, RETAIN FOR FUTURE REFERENCE\*  
PLEASE READ CAREFULLY**







**Boori International**

AUSTRALIA  
18-20 Charles Street  
St. Marys Sydney NSW  
2760 Australia  
Ph: 612 9833 3769 Fax: 612 9673 4240

Boori (UK) Ltd  
Unit 8, Transigo,  
Gables Way, Kennet Park,  
Thatcham, Berkshire,  
RG19 4ZA  
Ph: (44) 016 3529 5670 Fax: (44) 016 3587 7552

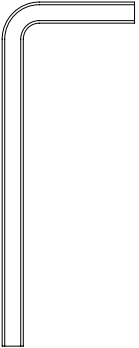
**Newport Changing Tray**

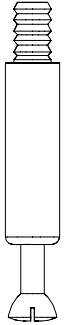
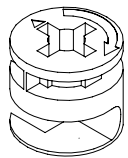
**Hardware and parts list**

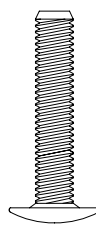
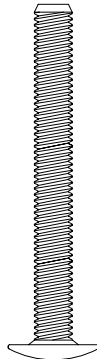
1 x Allen Key	6 x Wood dowels	2 x Connecting bolts	2 x Excenter fittings	2 x Trim caps	5 x 25mm Connecting bolts	2 x 45mm Connecting bolts
<b>A</b>	<b>B</b>	<b>C</b>	<b>D</b>	<b>E</b>	<b>F</b>	<b>G</b>
						
					Actual size	Actual size

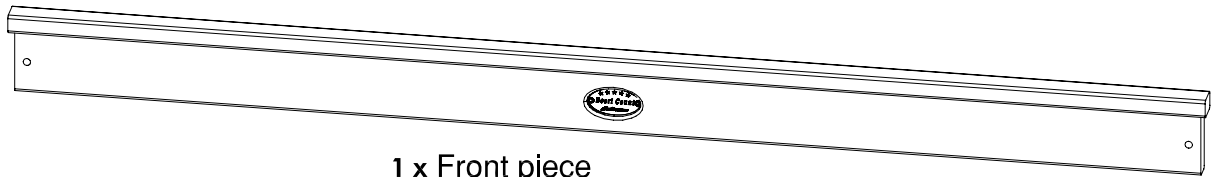

1 x Front piece

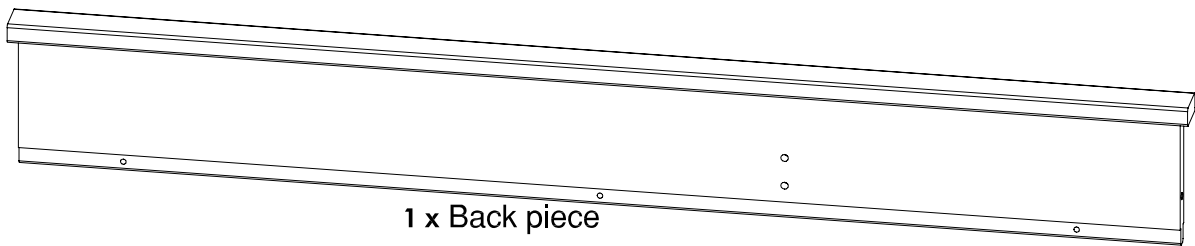

1 x Back piece

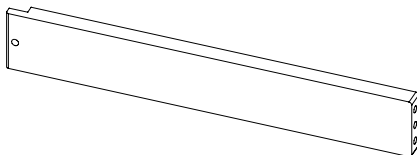

1 x Left piece

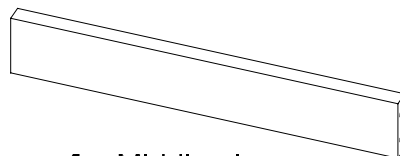

1 x Middle piece

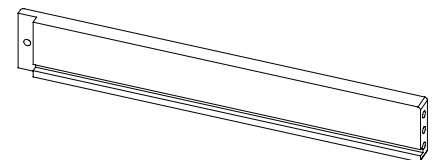

1 x Right piece

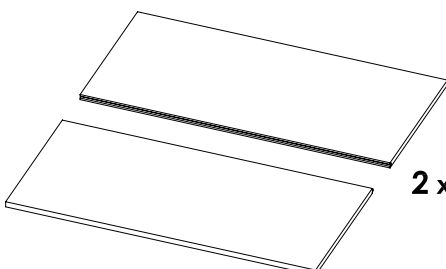

2 x Base board (Left & Right)

## Assembling the Newport Changing Tray

### Stage 1:

Attach left piece and right piece and middle piece to back piece with 2 x **F** bolts and 1x **C** bolt and 1 x **B** wood dowels and 1 x **D** excenter fitting .

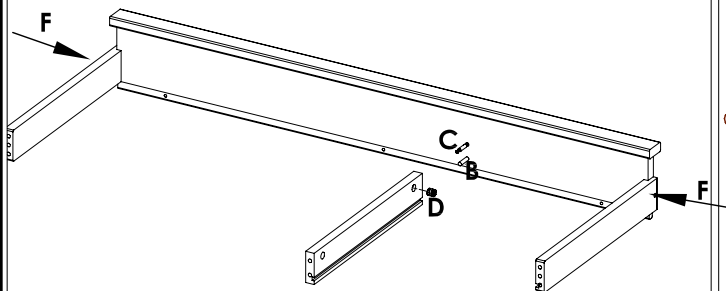

### Stage 2:

A) Slide base board into the grooves of right piece and middle piece

B) And then attach front piece with 2 x **G** bolts and 1x **C** bolt and 5 x **B** wood dowels and 1 x **D** excenter fitting

C) Cover the excenter fitting in middle piece with 2 x **E** trim caps .

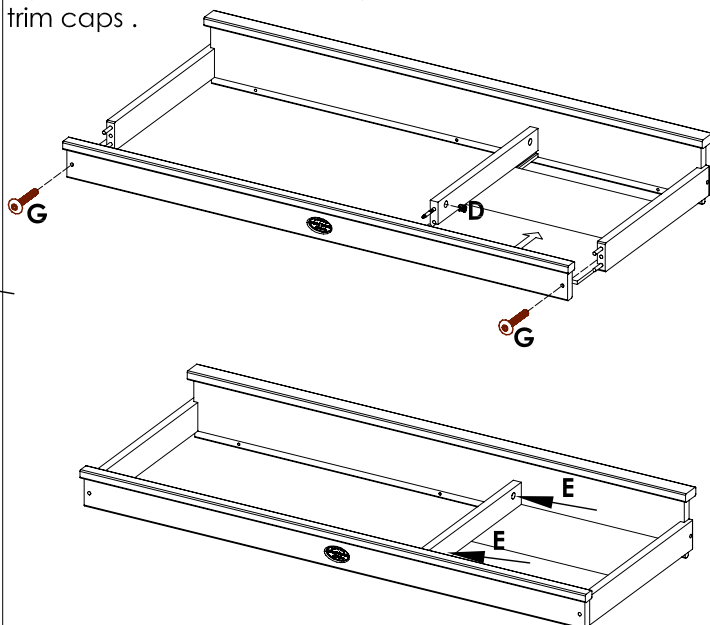

### Stage 3:

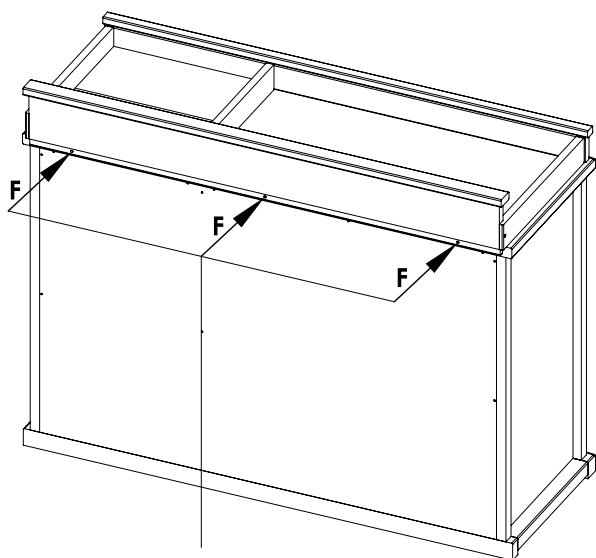

Attach the Newport changing tray to the back of chest with 3 x **F** connecting bolts.



### Maintenance of your Boori Country Furniture

- \* TO ENSURE THE SAFETY OF YOUR COT, BED OR CHANGE TABLE, REGULARLY CHECK ALL THE CONNECTING BOLTS AND GLIDE PINS MAKING SURE THEY ARE TIGHT, CARE SHOULD BE TAKEN THAT NO SCREWS ARE LOOSE
- \* GLIDE PINS AND BOLTS SHOULD BE TIGHTENED EVERY FOUR TO SIX MONTHS TO ENSURE COT/FURNITURE REMAINS STABLE
- \* TO CLEAN YOUR COT & FURNITURE USE A SOFT CLOTH DAMPENED WITH WATER
- \* DO NOT USE STRONG HOUSEHOLD CLEANERS
- \* AVOID CONTACT WITH SHARP OBJECTS
- \* WHEN MOVING YOUR COT, BED OR FURNITURE DO NOT DRAG, ALWAYS LIFT AND PLACE IN POSITION