

Boori

Universal



Halo Net & Stand

圆顶蚊帐

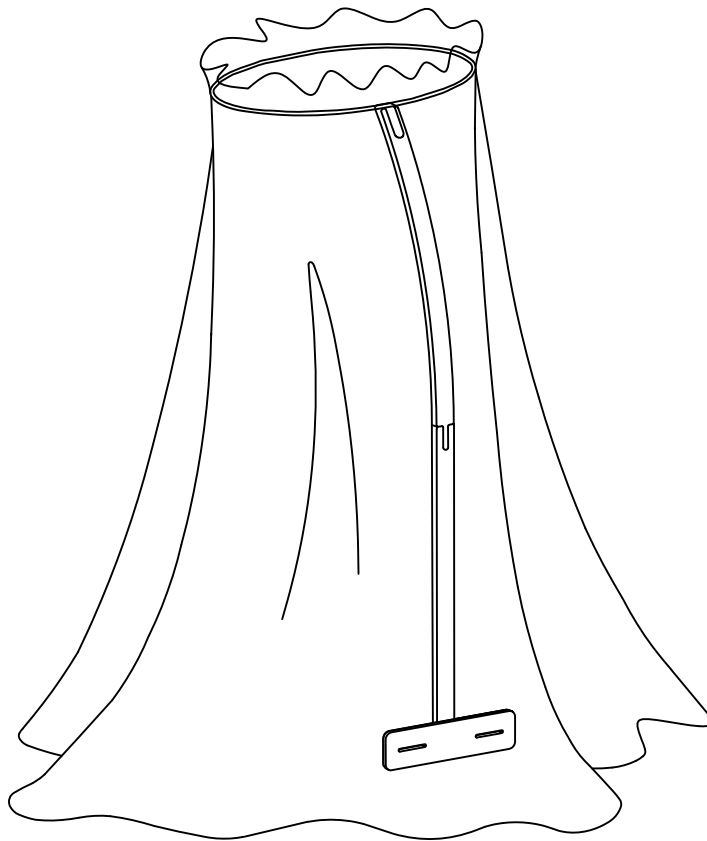

**IMPORTANT:
PLEASE READ THE INSTRUCTIONS CAREFULLY
AND KEEP FOR FUTURE REFERENCE**

重要：请仔细阅读此说明书，并妥善保管以便日后参考。

Boori Australia Pty Ltd
 18-20 Charles Street
 St. Marys Sydney NSW
 2760 Australia
 Tel: +61 2 9833 3769
 Fax: +61 2 9673 4240
 www.boori.com.au

Boori (Europe) Ltd
 Untli 1 Riverside House,
 Mill Lane, Newbury,
 Berkshire, RG14 5QS UK
 Tel: +44 016 3529 5670
 Fax: +44 016 3587 7552
 www.boori.co.uk

Halim & Boori Company
 10F. Halim INT'L B/D, #1674-4,
 Seocho-Dong, Seocho-Gu,
 Seoul, Korea
 Tel: +82 2598 1470
 Fax: +82 2583 8885
 E-mail: ted@boori.co.kr
 Postal code: 137-725.

ブーリジャパン(株)
 〒541-0057
 日本国大阪府大阪市
 中央区北久宝寺町4-2-10
 Tel: +06-4963-3939
 Fax: +06-4963-3900
 E-mail: info@boori.co.jp

博瑞儿童用品(上海)有限公司
 上海市青浦区徐泾镇华徐公路577号
 VEG微格创意园A8-10室
 邮编: 201702
 电话: +86 21 5296 6600
 传真: +86 21 5296 6636
 网址: www.boori.com.cn

Halo Net & Stand (B-HANS)

Dimensions : 160*80*180cm
 产品规格 : 160*80*180cm

Main Materials : European Beech、Polyester
 主要材质: 欧洲山毛榉、聚酯纤维

Hardware / 五金单

A x 2

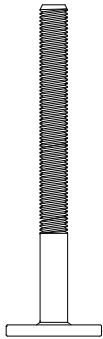

M5*45mm

B x 2

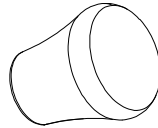

C x 1

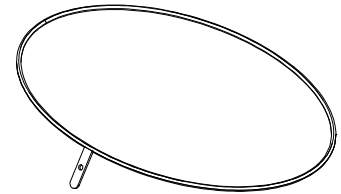

Parts List / 部件清单

① x 1

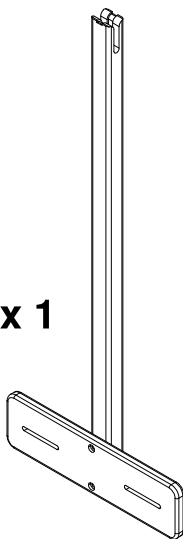

② x 1

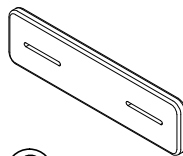

③ x 1

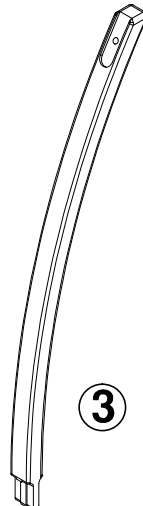

④ x 1



Assembly / 安装说明

1

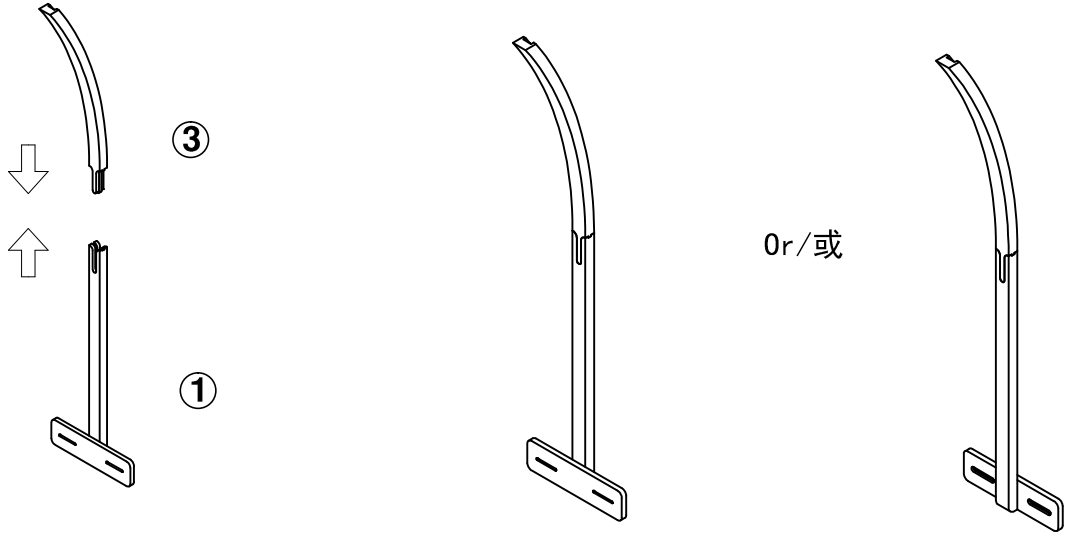

2

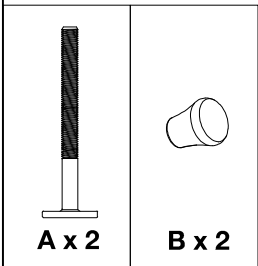
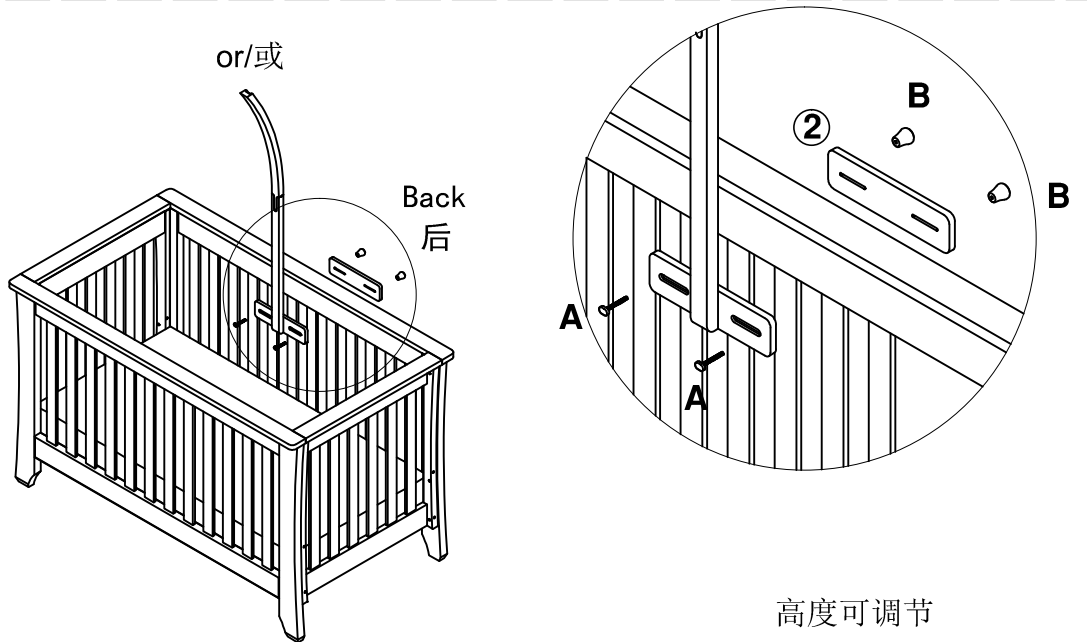
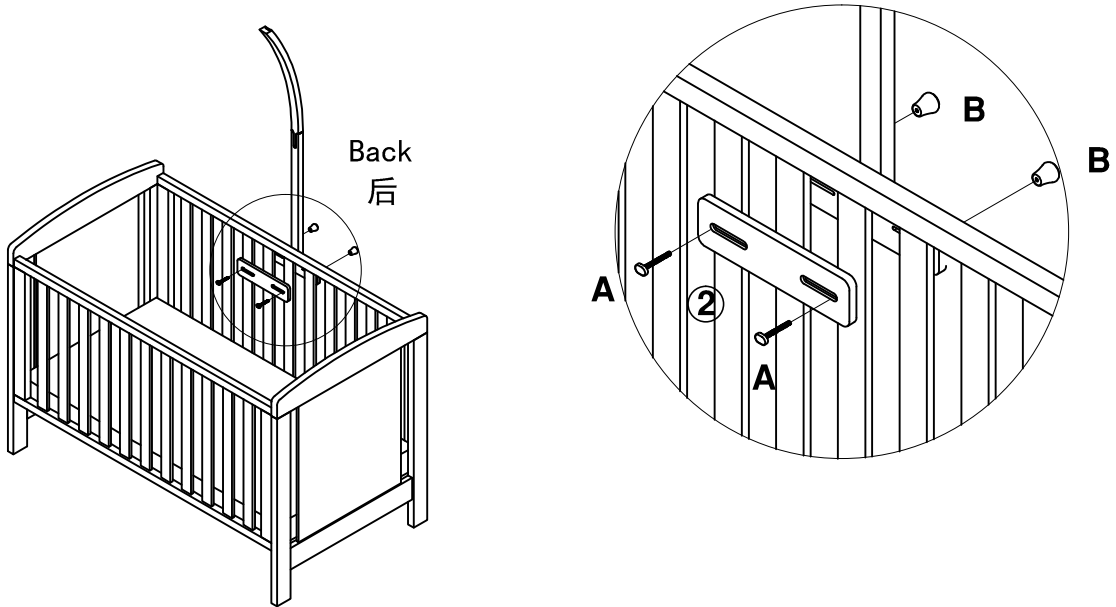

高度可调节
Height can be adjusted

Assembly / 安装说明

3

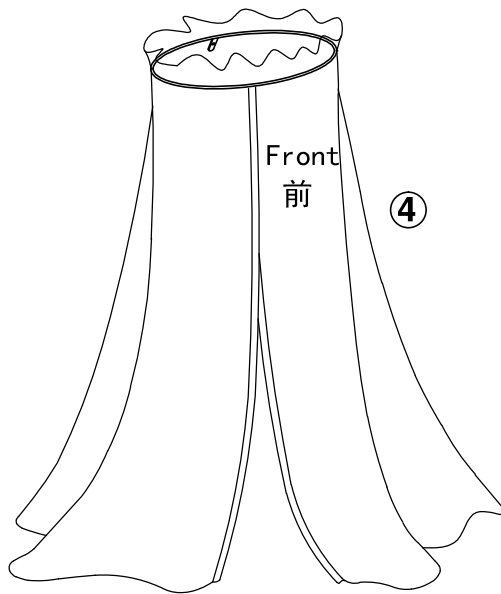

Back
后

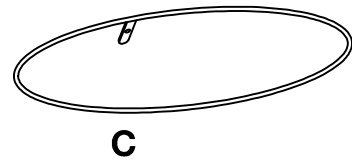

Front
前



C x 1

4

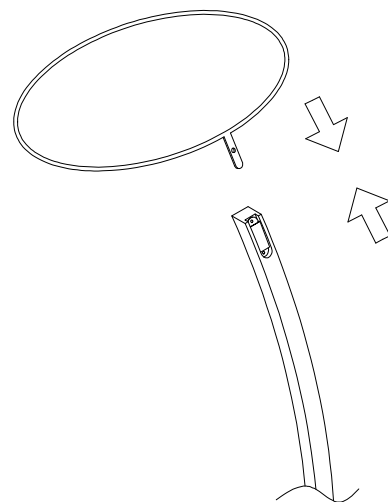

Note: Regularly check all the connecting Bolts and Glide Pins making sure they are tightened
注意: 定期检查所有的螺丝和螺杆并确保它们紧固。