

AC INFINITY

**DUCT CARBON FILTER XL**  
PREMIUM AUSTRALIAN CHARCOAL

USER MANUAL



## WELCOME

Thank you for choosing AC Infinity. We are committed to product quality and friendly customer service. If you have any questions or suggestions, please don't hesitate to [contact](#) us. Visit [www.acinfinity.com](http://www.acinfinity.com) and click contact for our contact information.

### EMAIL

[support@acinfinity.com](mailto:support@acinfinity.com)

### WEB

[www.acinfinity.com](http://www.acinfinity.com)

### LOCATION

Los Angeles, CA

## MANUAL CODE DCF2303X1

### PRODUCT

DUCT CARBON FILTER XL, 4"

DUCT CARBON FILTER XL, 6"

DUCT CARBON FILTER XL, 8"

### MODEL

AC-DCF4-XL

AC-DCF6-XL

AC-DCF8-XL

### UPC-A

819137023000

819137023017

819137023024

# MANUAL INDEX

Manual Index .....	Page 5
Key Features .....	Page 6
Product Contents .....	Page 7
Installation .....	Page 8
Overhead Hanging .....	Page 10
Configuration Set-up .....	Page 14
Maintenance .....	Page 17
Other AC Infinity Products .....	Page 18
Warranty .....	Page 19

# KEY FEATURES

## MAX AIR PASSTHROUGH

Aluminum mesh allows complete passthrough of air suitable for both intake and exhaust applications.

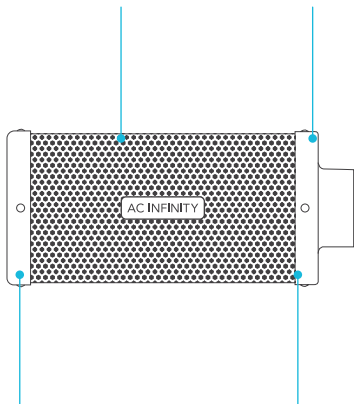

## FLANGE HANGERS

Hanging hooks enable use with rope clip hangers to securely install this carbon filter onto support beams.

## ALUMINUM FRAME

Features a resilient frame that resists corrosion and can be placed in high humidity settings.

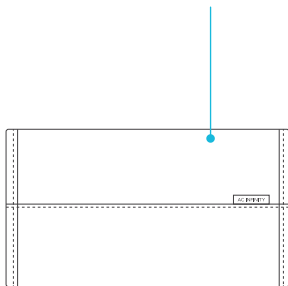

## ACTIVATED CARBON

Features RC412 1200+ IAV Australian charcoal with high adsorption rate to completely block odor and scrub the air.

## CLOTH FILTER COVER

Traps particles from passing through the carbon filter. Rewash every six months to extend its lifespan.

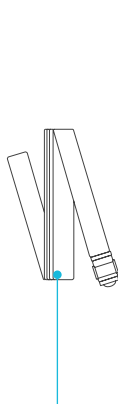

## FILTER STRAPS

Includes two nylon straps for reinforced hanging or other applications in your grow tent.

# PRODUCT CONTENTS

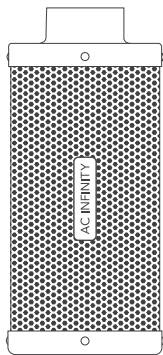

DUCT  
FILTER  
(x1)

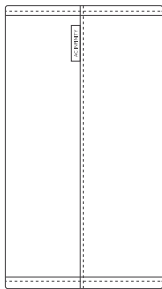

PREFILTER  
CLOTH  
(x2)

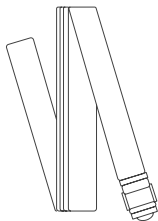

FILTER  
STRAPS  
(x2)

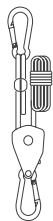

ROPE  
CLIPS  
(x2)

# INSTALLATION

## STEP 1

Slip the cloth over your filter to block dust and other particles from passing through. Make sure the entire metal mesh is covered by the cloth.

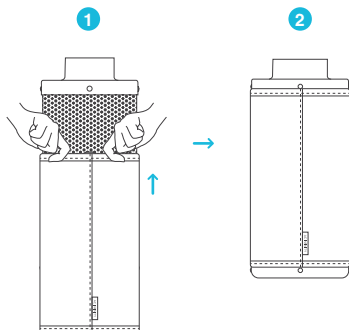

## STEP 2

Connect your duct tube over your filter. Use duct clamps to secure the connection. You may also apply ducting tape before using the duct clamps for even further security.

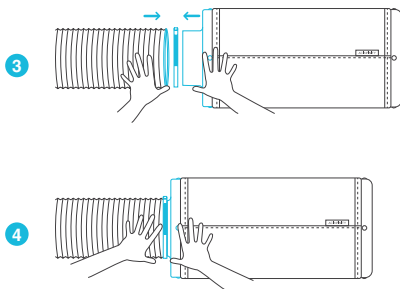



# INSTALLATION

## STEP 3

You may also connect your filter directly to your inline duct fan. Use ducting tape to secure them together.

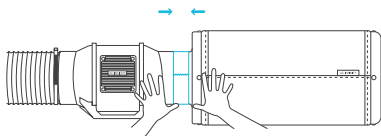

---

## STEP 4

If your filter is placed in a humid space, position it at the highest point possible.

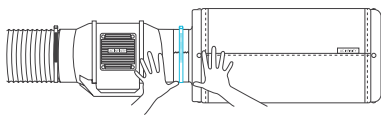

# OVERHEAD HANGING STRAPS

## STEP 1

Loop the strap around a hanging pole.

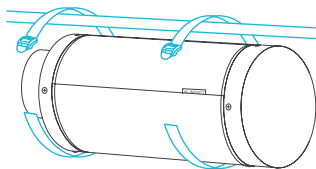

---

## STEP 2

Slip the strap through the inner ladder lock slot from the bottom.

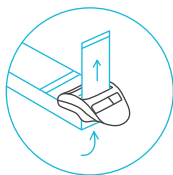

# OVERHEAD HANGING STRAPS

## STEP 3

Route the strap into the outer ladder lock slot from the top. Adjust the length of the completed loop as needed.

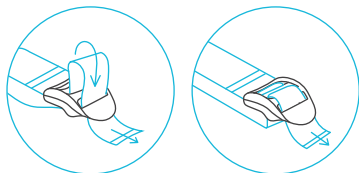

Adjust to size

---

## STEP 4

Tuck the loose ends through the center gap of the ladder lock to secure the loop.

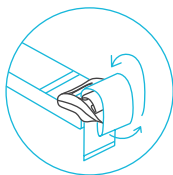

Loop through middle  
to lock in place

# OVERHEAD HANGING STRAPS

## STEP 5

Connect your filter to your ductwork using your preferred method, as shown on page 8 and 9.

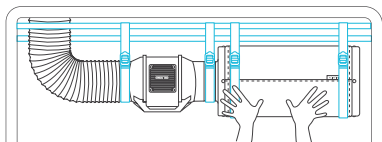

# OVERHEAD HANGING

## ROPE CLIPS

### STEP 1

Loop the rope clip hangers around your grow tent's support beams.

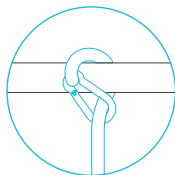

---

### STEP 2

Hook the carabiners into the steel hooks located on the flanges.

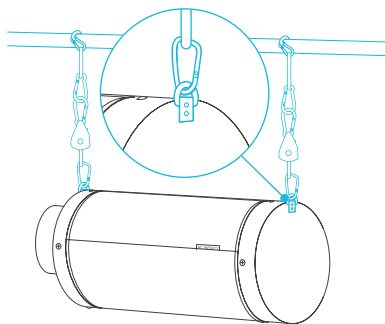

# INSTALLATION

## CONFIGURATION SET-UP

### INTERIOR HANGING

To use this filter in intake applications, place the filter inside your grow space. Make sure your filter is connected to your inline duct fan's intake end before completing the installation.

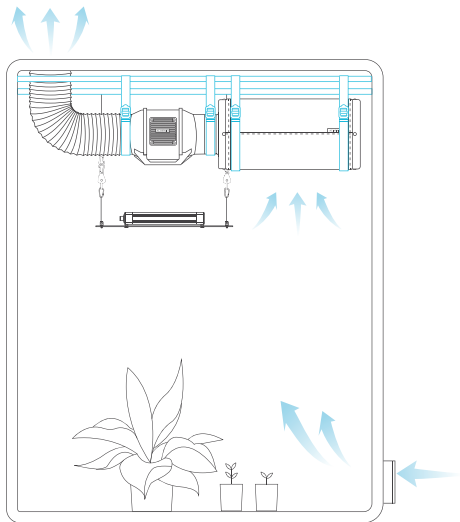

# INSTALLATION

## CONFIGURATION SET-UP

### EXTERIOR MOUNTING

To use this filter in exhaust applications, place the filter outside of your grow space. Make sure your filter is connected to your inline duct fan's exhaust end before completing the the installation. Stuff the prefilter inside of the filter to lengthen the carbon bed's lifespan.

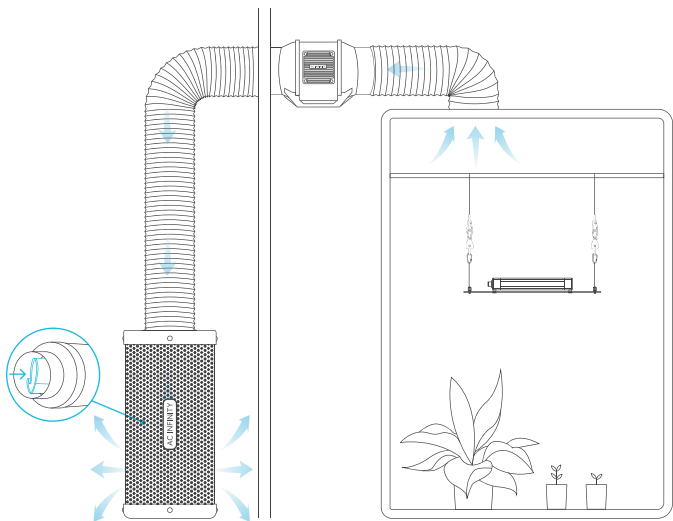

# INSTALLATION

## CONFIGURATION SET-UP

### OVERSIZED GROW SPACE

Use a dual fan and filter combination inside your grow space to completely scrub away odor in larger grow rooms and tents. Set the secondary filter on the floor and the inline fan on top of it so that the exhaust end points up.

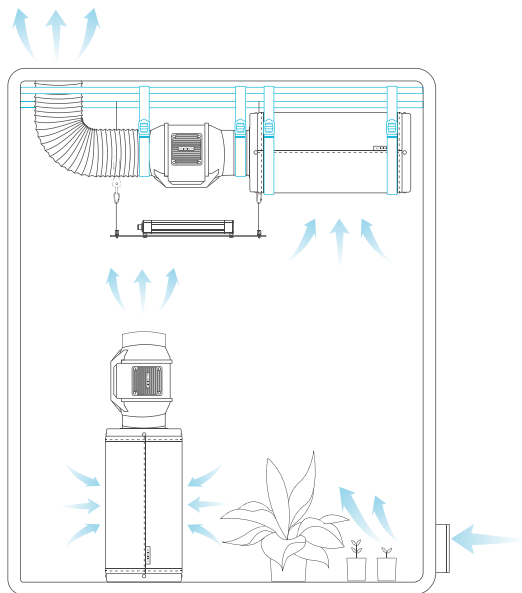



# MAINTENANCE

## WASHING THE PREFILTER

Wash the reusable cloth as needed to clear it of any dust and build-up. This will further extend the lifespan of the filter.

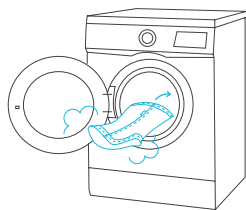

# AC INFINITY PRODUCTS

## Advance Grow Tent

The CLOUDLAB series is a line of grow tents designed to create ideal growing conditions and facilitate indoor plant cultivation year-round. Features 2000D thick oxford canvas lined with inner diamond patterned mylar that maximizes grow light luminosity, and a reinforced frame with 150 lb. weight capacity.

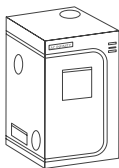

---

## Inline Fans

The CLOUDLINE series is a line of duct fans designed to quietly ventilate AV rooms and closets, as well as various DIY air circulation and exhaust projects. Features a thermal controller with intelligent programming that will automatically adjust duct fan speeds in response to changing temperatures.

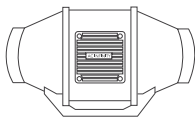

---

## Ducting Tubes

The four-layer ducting tube is used to direct airflow, designed for ventilation systems in applications like HVAC, dryers, and grow rooms. It is highly durable and flexible, and can be used anywhere from tight spaces to wide open areas.

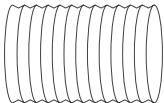

Discover the latest innovations in cooling and ventilation at [acinfinity.com](http://acinfinity.com)

# WARRANTY

This warranty program is our commitment to you, the product sold by AC Infinity will be free from defects in manufacturing for a period of two years from the date of purchase. If a product is found to have a defect in material or workmanship, we will take the appropriate actions defined in this warranty to resolve any issues.

The warranty program applies to any order, purchase, receipt, or use of any products sold by AC Infinity or our authorized dealerships. The program covers products that have become defective, malfunctioned, or expressively if the product becomes unusable. The warranty program goes into effect on the date of purchase. The program will expire two years from the date of purchase. If your product becomes defective during that period, AC Infinity will replace your product with a new one or issue you a full refund.

The warranty program does not cover abuse or misuse. This includes physical damage, submersion of the product in water, incorrect installation such as wrong voltage input, and misuse for any reason other than intended purposes. AC Infinity is not responsible for consequential loss or incidental damages of any nature caused by the product. We will not warrant damage from normal wear such as scratches and dings.

Contact our dealers department at [dealers@acinfinity.com](mailto:dealers@acinfinity.com) or (626) 838-4656 for more information about our dealers and distributors program. Contact our customer service department at [support@acinfinity.com](mailto:support@acinfinity.com) or 626-923-6399 for product and warranty assistance. Our business hours are Monday through Friday, 9:00 am to 5:00 pm PST.



**If you have any issues with this product, contact us and we'll happily resolve your problem or issue a full refund!**

**COPYRIGHT © 2023 AC INFINITY INC. ALL RIGHTS RESERVED**

No part of the materials including graphics or logos available in this booklet may be copied, photocopied, reproduced, translated or reduced to any electronic medium or machine readable form, in whole or in part, without specific permission from AC Infinity Inc.







[www.acinfinity.com](http://www.acinfinity.com)