

AC INFINITY

IONGRID SERIES

GROW LIGHT SYSTEM

USER MANUAL

WELCOME

Thank you for choosing AC Infinity. We are committed to product quality and friendly customer service. If you have any questions or suggestions, please don't hesitate to [contact](#) us. Visit www.acinfinity.com and click contact for our contact information.

EMAIL

support@acinfinity.com

WEB

www.acinfinity.com

LOCATION

Los Angeles, CA

MANUAL CODE IG2108X2

PRODUCT

IONGRID S22
IONGRID S24
IONGRID S33
IONGRID S44
IONGRID T22
IONGRID T24
IONGRID T33
IONGRID T44

MODEL

AC-IGS22
AC-IGS24
AC-IGS33
AC-IGS44
AC-IGT22
AC-IGT24
AC-IGT33
AC-IGT44

UPC-A

819137021921
819137022157
819137022119
819137022171
819137021914
819137022164
819137022126
819137022188

MANUAL INDEX

Manual Index	Page 5
Key Features	Page 6
Product Contents	Page 7
Installation	Page 8
Power and Setup	Page 10
Adding More Lights	Page 12
Starter Guide	Page 13
Programming	Page 14
Other AC Infinity Products	Page 27
Warranty	Page 28

KEY FEATURES

SAMSUNG LED DIODES

Built with genuine Samsung LM301H full spectrum LEDs running at 100W & 2.7 $\mu\text{mol}/\text{j}$ for high efficiency lighting.

EVEN COVERAGE

Unique halo form factor provides wider light spread, maximizing usable growing space while eliminating hot spots.

SMART CONTROLLER

Features 0-100% dimming and various time-based programming. UI5™ ports enable daisy chaining.

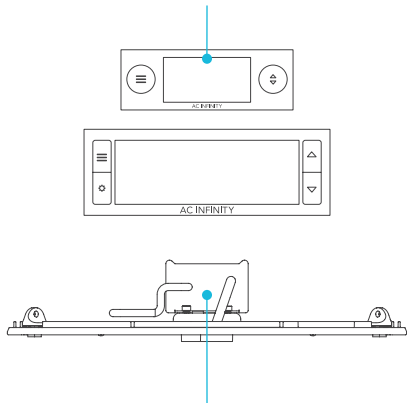
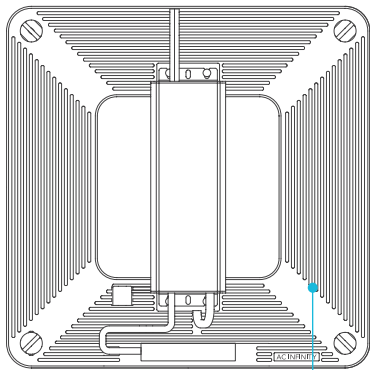

IP-67 PROTECTION

Sealed to Ingress Protection 67 standards against liquids and dust for excellent performance in grow tent environments.

THERMALLY OPTIMIZED

Aluminum frame with thermal compound offers no-noise heat dissipation to keep the grow light cool over extended use.

CUSTOM LED DRIVER

Designed to reliably deliver high-wattage power and enables PWM control of its power output.

PRODUCT CONTENTS

IONGRID S-Series



GROW
LIGHT
(x1)



CONTROLLER
77
(x1)

IONGRID T-Series



GROW
LIGHT
(x1)



CONTROLLER
78
(x1)

Included in both S-Series and T-Series

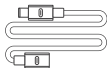

EXTENSION
CORD
(x1)



STAINLESS STEEL
WIRE HANGER
(x1)



ROPE
CLIP
(x1)



WOOD SCREWS
(WALL MOUNT)
(x2)

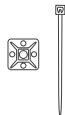

WIRE
TIE SET
(x1)



VELCRO
TIE SET
(x4)

INSTALLATION

STEP 1

Clip the lanyard hooks onto the four anchors located at the corners of the grow light.

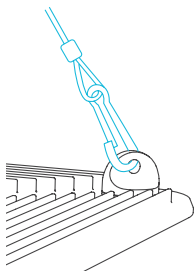

STEP 2 - SINGLE WIRE HANGER

Clip the carabiner onto your grow tent's roof support beams.

You may also use a rope clip hanger to hang the grow light lower.

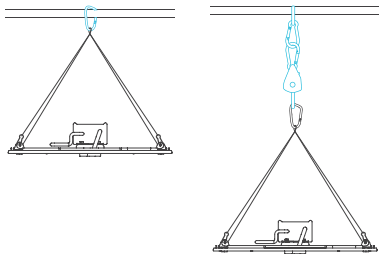

INSTALLATION

STEP 3 - SPLIT WIRE HANGER

Release two of the hanger's cords from the carabiner and clip them into a separate carabiner (not included).

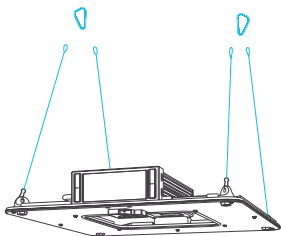

STEP 4 - SPLIT WIRE HANGER

Clip the two carabiners onto your grow tent's roof support beams.

You may also use rope clip hangers to hang the grow light lower.

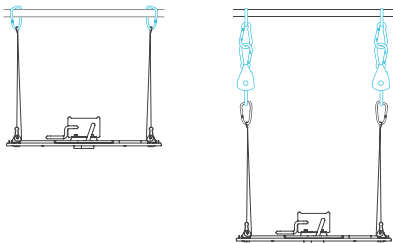

POWERING AND SETUP

STEP 1

Plug the LED driver's cable into one of the controller's ports.

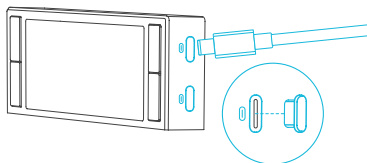

*Remove rubber cap

STEP 2

Plug the power cord into an AC power outlet to power the grow light and controller.

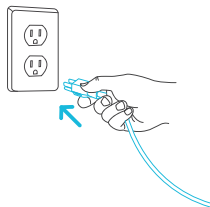

POWERING AND SETUP

RELOCATING THE CONTROLLER

STEP 1

Unplug the connector and unscrew the bolts on the underside to remove the controller from the grow light.

Connect the extension cord in between the driver's cord and the controller.

This extension cord is intended for use with AC Infinity products only.

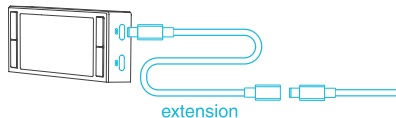
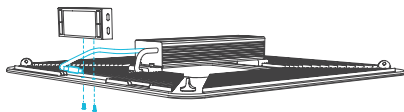

STEP 2

Drill holes into your surface and insert the wood screws to hang the controller.

The controller (CONTROLLER 78 only) will also magnetically mount onto the CLOUDLAB series advance grow tent's controller mounting plate (sold separately).

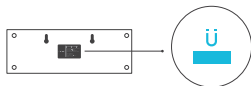
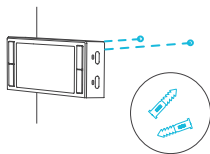

The magnet will be located under the controller's label.

ADDING MORE LIGHTS

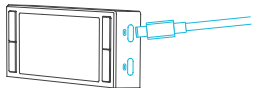

Your IONGRID controller is equipped with multiple ports to add more grow lights and share the same programming. Refer to the diagram below to learn how to connect additional units.

The controller can program light intensity levels and scheduled activations of all grow lights plugged into its UIS™ ports. S-Series controllers are equipped with two ports while T-Series controllers are equipped with four ports.

An expansion dongle (sold separately) will allow you to daisy-chain additional grow lights past the number of units your controller can support.

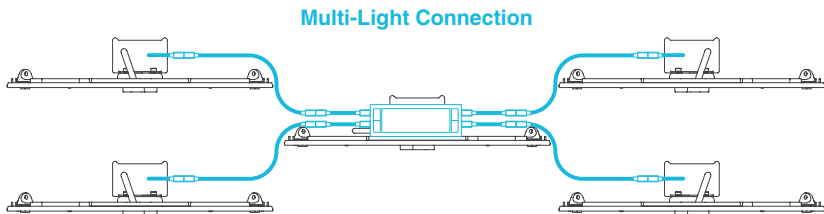

EXPANSION DONGLE

The expansion dongle will allow you to connect 2 or 4 more devices and can be daisy-chained to create more expansion ports (up to 64 units supported with the use of 20 dongles). Intended for exclusive use with AC Infinity controllers built with UIS™ ports.

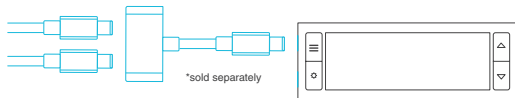

STARTER GUIDE

The charts below offer suggested mounting heights and light intensities for each stage in the growing process of your preferred method. These factors will vary based on the plant you are growing. Height refers to distance from the canopy (tip of the plant).

HEIGHT ADJUSTMENT	Seedling Stage	Vegetative Stage	Flowering Stage
Height	3 ft.	2 ft.	1.5 ft.
Intensity	100%	100%	100%



LIGHT ADJUSTMENT	Seedling Stage	Vegetative Stage	Flowering Stage
Height	1.5 ft.	1.5 ft.	1.5 ft.
Intensity	30%	70%	100%



PROGRAMMING

S-SERIES

1. MODE BUTTON

Cycles through each of the controller modes: OFF, ON, TIMER TO ON, TIMER TO OFF, and CYCLE (ON and OFF).

2. UP/DOWN BUTTON

Adjusts the setting of your current mode. Holding this button will lock the controller; pressing this button afterwards will turn off the display.



3. USER SETTING

Displays the grow light's intensity level as well as countdown timers of the TIMER TO ON, TIMER TO OFF and CYCLE (ON and OFF) modes.

4. CONTROLLER MODE

Displays the controller's current mode. Pressing the mode button cycles through the available modes.

PROGRAMMING

S-SERIES

CONTROLLER MODES

Pressing the mode button will cycle through the controller's available programming modes and settings: OFF, ON, TIMER TO ON, TIMER TO OFF, and CYCLE.

OFF MODE

Your grow light will not activate while in this mode. The intensity level set here establishes the minimum intensity level in the other modes. When the light is triggered to turn off in all other modes, it will instead shine at the level set here.



ON MODE

Your grow light will activate to the intensity level set here. The ON mode also serves as the maximum intensity level setting the other modes will shine in.



TIMER TO ON MODE

Use the up/down button to set a countdown to trigger ON mode. Once the timer ends, the grow light will shine at the intensity level set in ON mode. If there is a level set in OFF mode greater than 0, the grow light will shine at that level during the countdown.

The countdown will begin if no buttons are pressed for 5 seconds. Leaving the TIMER mode while the countdown is running will pause it until you return to this mode.



The grow light will shine at the intensity level set in OFF mode while it is deactivated.

PROGRAMMING

S-SERIES

TIMER TO OFF MODE

Use the up/down button to set a countdown to trigger OFF mode. The grow light will shine at the intensity level set in ON mode until the countdown ends. If there is a level set in OFF mode greater than 0, the grow light will shine at that level at the end of the countdown.

The countdown will begin if no buttons are pressed for 5 seconds. Leaving the TIMER mode while the countdown is running will pause it until you return to this mode.



The grow light will shine at the intensity level set in OFF mode while it is deactivated.

CYCLE MODE (ON & OFF)

Sets an on duration and an off duration for the grow light to cycle through continuously. Use the up/down button to first set a duration for the grow light to be on, then press the mode button and set a duration for the grow light to be off.

While the grow light is activated, it will shine at the level set in ON mode. While the grow light is deactivated, it will shine at the level set in OFF mode.

The countdown will begin if no buttons are pressed for 5 seconds. Leaving the CYCLE mode while the countdown is running will pause it until you return to this mode.



The grow light will shine at the intensity level set in OFF mode while it is deactivated.

PROGRAMMING

S-SERIES

DISPLAY SETTING

Adjusts the display brightness and auto-dimming. Press the mode and up/down buttons together to cycle through levels 1, 2, 3, A2 and A3; 3 being the highest brightness setting, while 1 is the lowest. In settings 1, 2 and 3, the display will stay at that brightness level and will not automatically dim the display.

A2 and A3 will set the brightness level at 2 and 3, respectively, and will dim the brightness level down to 1 when the controller is not being used after 30 seconds.



TOGGLING THE DISPLAY

Lock the controller by holding the up/down button.

Press the up/down button to turn the display off. Pressing the up/down button again will turn the display back on.

Programs will still run in the background while the LCD screen is off.



HOLD +



PRESS +



OTHER SETTINGS

S-SERIES

FACTORY RESET

Holding the mode and up/down buttons together for 5 seconds will reset your controller and restore factory settings. This will clear all user set parameters of each controller mode and setting.



CONTROLLER LOCK

Holding the up/down button will lock the controller in your current mode. While your controller is locked, no parameters may be adjusted nor will you be able to switch modes. Holding the up/down button again will unlock the controller.



HIDE SCREEN

Lock the controller so no settings can be adjusted. See above. Then press the up/down button to turn the display off. Pressing the up/down button again will turn the display back on. Programs will still run in the background while the LCD screen is off.



JUMP TO OFF MODE

Holding the mode button for 3 seconds while in any mode or setting will automatically jump to OFF Mode. This function is disabled if the controller is locked.



PROGRAMMING

T-SERIES

1. MODE BUTTON

Cycles through the controller modes: OFF, ON, TIMER TO ON, TIMER TO OFF, CYCLE (On and Off) and SCHEDULE 1, 2, 1+2 (On and Off).

2. SETTING BUTTON

Cycles through each of the three controller settings: DISPLAY, CLOCK, and TRANSITION.

3. UP/DOWN BUTTONS

Adjusts the setting of your current mode. The up button increases and down button decreases the setting. Hold both to reset settings.



4. CURRENT TIME

Displays the current time. The internal battery sustains the clock so it does not default to 00:00 if power is cut off. See page 24 to learn how to set the clock time.

5. BRIGHTNESS

Displays the current intensity level. Includes a trend indicator that signals if the intensity level is rising, falling, or holding steady.

6. USER SETTING

Displays the value of your current mode. Use the up and down buttons to adjust the value.

7. COUNTDOWN

Displays the countdown of the TIMER TO ON, TIMER TO OFF, CYCLE, or SCHEDULE modes. TO ON shows the amount of time left before the light turns on. TO OFF shows the amount of time left before the light turns off.

8. CONTROLLER MODE

Displays the controller's current mode. Pressing the mode button cycles through the available modes.

9. STATUS ICONS

Alerts you of the controller's status notifications. Icons include TIMER ALERT and DISPLAY LOCK.

PROGRAMMING

T-SERIES

CONTROLLER MODES

Pressing the mode button will cycle through the controller's available programming modes: OFF, ON, TIMER TO ON, TIMER TO OFF, CYCLE, and SCHEDULE.

OFF MODE

Your grow light will not activate while in this mode. The intensity level set here establishes the minimum intensity level in the other modes. When the light is triggered to turn off in all other modes, it will instead shine at the level set here.



ON MODE

Your grow light will activate to the intensity level set here. The ON mode also serves as the maximum intensity level setting the other modes will shine in.



TIMER TO ON MODE

Use the up and down buttons to set a countdown to trigger ON mode. Once the timer ends, the grow light will shine at the intensity level set in ON mode. If there is a level set in OFF mode greater than 0, the grow light will shine at that level during the countdown.



The grow light will shine at the intensity level set in OFF mode while it is deactivated.

The countdown will begin if no buttons are pressed for 5 seconds. This is located at the bottom left corner of the display. Leaving the TIMER mode while the countdown is running will pause it until you return to this mode.

PROGRAMMING

T-SERIES

TIMER TO OFF MODE

Use the up and down buttons to set a countdown to trigger OFF mode. The grow light will shine at the intensity level set in ON mode until the countdown ends. If there is a level set in OFF mode greater than 0, the grow light will shine at that level at the end of the countdown.

The countdown will begin if no buttons are pressed for 5 seconds. This is located at the bottom left corner of the display. Leaving the TIMER mode while the countdown is running will pause it until you return to this mode.



The grow light will shine at the intensity level set in OFF mode while it is deactivated.

CYCLE MODE (ON & OFF)

Sets an on duration and an off duration for the grow light to cycle through continuously. Use the up and down buttons to first set a duration for the grow light to be on, then press the mode button and set a duration for the grow light to be off.

While the grow light is activated, it will shine at the level set in ON mode. While the grow light is deactivated, it will shine at the level set in OFF mode.

The countdown will begin if no buttons are pressed for 5 seconds. This is located at the bottom left corner of the display. Leaving the CYCLE mode while the countdown is running will pause it until you return to this mode.



The grow light will shine at the intensity level set in OFF mode while it is deactivated.

PROGRAMMING

T-SERIES

SCHEDULE MODE 1, 2 (ON & OFF)

Sets an on clock time and an off clock time schedule for the grow light to follow daily. Use the up and down buttons to first set an on clock time to trigger ON mode, then press the mode button to set an off clock time to trigger OFF mode. Please be sure to set the current clock time under settings.

Two schedules can be programmed and run separately in modes SCHEDULE 1 and SCHEDULE 2.

While the grow light is activated, it will shine at the level set in ON mode. While the grow light is deactivated, it will shine at the level set in OFF mode.

The countdown will begin if no buttons are pressed for 5 seconds. This is located on bottom left corner of the display. Leaving the SCHEDULE mode will pause the schedule, while re-entering it will continue the latest schedule you have set.

SCHEDULE MODE 1+2

This mode combines the settings of both schedule programming, taking the earlier activation time of 1 and 2 and the earlier deactivation time of 1 and 2.

For example, SCHEDULE 1 is set to activate at 2:00pm and deactivate at 3:00pm. SCHEDULE 2 is set to activate at 1:00pm and deactivate at 4:00pm. SCHEDULE 1+2 will set the activation time at 1:00pm and the deactivation time at 3:00pm.



The grow light will shine at the intensity level set in OFF mode while it is deactivated.

PROGRAMMING

T-SERIES

CONTROLLER SETTINGS

Pressing the setting button will cycle through the controller's available settings: DISPLAY, CLOCK, and TRANSITION.

DISPLAY SETTING

Adjusts the display brightness and auto-dimming. Press the up or down button to cycle through levels 1, 2, 3, A2 and A3; 3 being the highest brightness setting, while 1 is the lowest. In settings 1, 2 and 3, the display will stay at that brightness level and will not automatically dim the display.

A2 and A3 will set the brightness level at 2 and 3, respectively, and will dim the brightness level down to 1 when the controller is not being used after 30 seconds.



TOGGLING THE DISPLAY

Lock the controller by holding the setting button.

Press the setting button to turn the display off. Pressing the setting button again will turn the display back on.

Programs will still run in the background while the LCD screen is off.



PROGRAMMING

T-SERIES

CLOCK SETTING

Adjusts the current clock time. Use the up and down buttons to adjust the time. Once you cycle through 12:00 each time, the units will automatically change to AM or PM. The clock time is located at the center of the display.

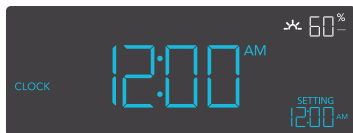

The internal battery sustains the clock so that it does not default to 00:00 if power is cut off.

TRANSITION SETTING

Adjusts the transition duration, in seconds, between the grow light intensity levels.

Use the up and down buttons to adjust the transition setting between 0 and 10 seconds. The higher the transition level, the more gradual the grow light will dim or illuminate towards the OFF mode or ON mode setting, and vice versa.

For example, if your transition setting is 6, it will take six seconds for the grow light to increase its brightness level from 30% to 40%.

If your transition setting extends the illumination or dimming time past your CYCLE mode timers, the intensity level will stop adjusting at the end of the timer.



Intensity Level	Transition
ON Mode = 60%	Setting = 6 Seconds
OFF Mode = 0%	

60%	6 sec.
50%	6 sec.
40%	6 sec.
30%	6 sec.
20%	6 sec.
10%	6 sec.
0%	

PROGRAMMING

T-SERIES

ALERT ICONS

The alert icons are displayed at the top of the screen. Icons may flash when the controller signals an alert to tell you a function or alarm is being triggered.

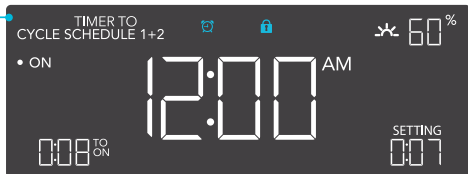

TIMER ALERT

Flashes when a countdown has completed in the TIMER TO ON, TIMER TO OFF, CYCLE, or SCHEDULE modes.



DISPLAY LOCK ALERT

Displays when the controller has been locked. The icon will flash to alert you that the controller is locked if you try to change the mode or settings.

OTHER SETTINGS

T-SERIES

FACTORY RESET

Holding the mode, up, and down buttons together for 5 seconds will reset the controller and restore factory settings. This will clear all user parameters in each controller mode and setting.



CONTROLLER LOCK

Holding the setting button will lock the controller in your current mode. While your controller is locked, no parameters may be adjusted nor will you be able to switch modes. Holding the power button again will unlock the controller.



HIDE SCREEN

Lock the controller so no settings can be adjusted. See above. Then press the setting button to turn the display off. Pressing the setting button again will turn the display back on. Programs will still run in the background while the screen is off.



JUMP TO OFF MODE

Holding the mode button for 3 seconds while in any mode or setting will automatically jump to OFF Mode. This function is disabled if the controller is locked.



SET MODE PARAMETER TO OFF

Holding the up and down buttons together for 2 seconds will reset the value of the current mode to OFF, 0 or - - - -. Pressing either the up or down button will return the parameter to the mode's last setting.



AUTO INCREASING OR DECREASING

Holding the up or down button will increase or decrease the user setting automatically until you release them.



AC INFINITY PRODUCTS

Advance Grow Tents

The CLOUDLAB series is a line of grow tents designed to create ideal growing conditions and facilitate indoor plant cultivation year-round. Features 2000D thick oxford canvas lined with inner diamond patterned mylar that maximizes grow light luminosity, and a reinforced frame with 150 lb. weight capacity. Includes a mounting plate to install your AC Infinity controller onto.

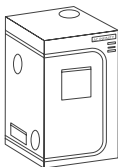

Inline Duct Fans

The CLOUDLINE series is a line of duct fans designed to quietly ventilate AV rooms and closets, as well as various DIY air circulation and exhaust projects. Features a thermal controller with intelligent programming that will automatically adjust duct fan speeds in response to changing temperatures.

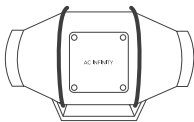

Carbon Filters

The duct carbon filter is designed to eliminate odors and chemicals for grow tents and hydroponic spaces. It utilizes premium grade Australian charcoal that features greater absorption power and a longer lifespan. Enables maximum airflow pass through as part of an intake or an exhaust system.

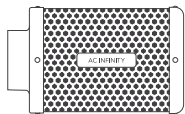

WARRANTY

This warranty program is our commitment to you, the product sold by AC Infinity will be free from defects in manufacturing for a period of two years from the date of purchase. If a product is found to have a defect in material or workmanship, we will take the appropriate actions defined in this warranty to resolve any issues.

The warranty program applies to any order, purchase, receipt, or use of any products sold by AC Infinity or our authorized dealerships. The program covers products that have become defective, malfunctioned, or expressively if the product becomes unusable. The warranty program goes into effect on the date of purchase. The program will expire two years from the date of purchase. If your product becomes defective during that period, AC Infinity will replace your product with a new one or issue you a full refund.

The warranty program does not cover abuse or misuse. This includes physical damage, submersion of the product in water, incorrect installation such as wrong voltage input, and misuse for any reason other than its intended purpose. AC Infinity is not responsible for consequential loss or incidental damages of any nature caused by the product. We will not warrant damage from normal wear such as scratches and dings.

For more information about our dealers and distributors, please contact our customer service at support@acinfinity.com or (626) 923-6399 Monday to Friday (9:00 am to 5:00 pm PST).



If you have any issues with this product, contact us and we'll happily resolve your problem or issue a full refund!

COPYRIGHT © 2021 AC INFINITY INC. ALL RIGHTS RESERVED

No part of the materials including graphics or logos available in this booklet may be copied, photocopied, reproduced, translated or reduced to any electronic medium or machine readable form, in whole or in part, without specific permission from AC Infinity Inc.

www.acinfinity.com