



SMART VIDEO INTERCOM KIT

2-Wire Technology
Smartphone Connectivity



Why Golmar?

IT'S NOT JUST WHAT WE DO,
IT'S THE WAY WE DO IT!



Enhanced Security and Safety

With a video intercom system, you never need to put yourself or your family at risk again. You can now screen visitors from the safety of your home, opening the door for trusted guests or keeping out unwanted or suspicious strangers.



24/7 Access Control

With multiple monitors installed around your home, you can answer your front door from any room. More sophisticated systems also allow you to view and respond to live images on mobile, no matter where you are located.



Save On Home Insurance Premiums

Investing in the right systems for your home not only protects your loved ones and your possessions, it can also save you money, reducing your claim risk and enabling you to take advantage of insurance premium discounts.



Increase the value of your property

When it comes to sale time, a home with a comprehensive alarm system supplemented by a video intercom system enhances the appeal of your home and could be the difference between a successful and unsuccessful sale.



A smart 2-wire digital video intercom which provides a high quality system with great features, easy wiring and an intuitive user interface. A kit specifically developed for small to medium size residential homes with scalability of up to 2 door stations and 4 monitors.

GL-SOUL 7W KIT

GL-ART7W



SOUL

GL-SOUL 7W KIT INCLUDES:

- 7" touchscreen monitor with integrated WiFi.
- Vandal-resistant outdoor door station with a single call button.
- Set of user key tags and 2 programming keys.
- Power supply



IK07 / IP44

GL-SOUL/1



GL-TAGSET/5

IK07 / IP44



G2+ Technology



2 wires - non polarized



x2 Up to 2 Door Stations



x2 Up to 2 CCTV Cameras



x4 Up to 4 monitors



Integrated WiFi Connectivity



G2CALL







App



GL-SOUL/1 Door Station

SOUL/1 door station is equipped with a 120° camera and a metallic pushbutton. SOUL/1 has a built-in light sensor that automatically illuminates at night, thanks to the incorporation of a photoelectric cell that also acts as the lighting LEDs for the camera. The door station is also equipped with LEDs indicating the function icons that displays the status of the system. Additionally you can connect to an analogue CCTV camera for added security. The door station is beautifully designed with an anti-vandal surface mounted panel in a zamak graphite finish.

SOUL

-  120° camera
-  Built-in RFID reader up to 20 users
-  Door lock activation through 12V DC output
Programmable output time
-  Second lock activation through 5Amp relay
Programmable relay time
-  Analogue CCTV camera input
-  Exit button input
Programmable lock and action time

 IK07 /  IP44

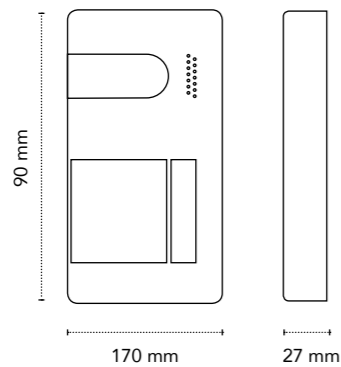

Manage calls from your smartphone with the G2Call app.



ART 7" wifi

G2+

- 7" capacitive touch screen monitor for surface installation
- High efficiency loudspeakers
- Call forwarding through WIFI to mobile phones (App G2Call available for Android and iOS)
- 2.4GHz frequency band
- Intercommunication with other units of the house selectively
- Personalisation of background colour and ring tones
- Multi-language - 16 languages available
- Image memory - Up to 100 photos in internal storage
- Micro SD Slot for extended retention period
- Up to 4 monitors in the same house without additional power
- 12V DC lock release
- Dimensions: 222(W) x 154(H) x 15(D) mm



Feeding



WiFi



Capture mode
Image or video



Door 1
Activated



Door 2
Activated









G2Call





ART7” easy_interface

communication menu

-  Turn off the screen
-  Enable / Disable WiFi
(Only Soul Art 7W model available)
-  Access to the recording menu
Images and videos
-  Preview the door station in spy mode
(View CCTV cameras, if connected)
-  Activate / Deactivate
Do not disturb
-  Settings menu
-  Call option selector
No function, take a picture or record video
-  Intercom menu
Intercommunication between monitors



GL-ART4 Additional Monitor

The smallest of the ART family, but with the same benefits as the ART 7W. ART 4 has a sleek design with a surface mountable 4.3" screen with soft touch function icons for intuitive operation. ART 4 is equipped with selectable image memory with storage up to 100 images in internal memory and video recording via optional SD card which automatically deletes recordings after 30 days. ART 4 has the option of intercommunication between monitors within the same house.

ART 4" G2+

- Additional monitor for GL-SOUL 7W Kit
- 4.3" screen with soft button
- High efficiency loudspeakers
- Image memory up to 100 photos in internal storage
- Micro SD card slot for video recording
- Selective intercom between monitors
- Selectable ringtones
- 12V DC lock release
- Dimensions: 110(W) 155(H) 10(D) mm



Access menu



Communication



Open door

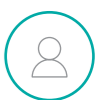

User

**GL-ART4 Monitor is not included in the kit and is sold separately*

Reduced dimensions, with the same benefits as ART 7W.

They call you and you're not at home ...
with the **G2Call** App it is no longer a problem.

Intuitive navigation

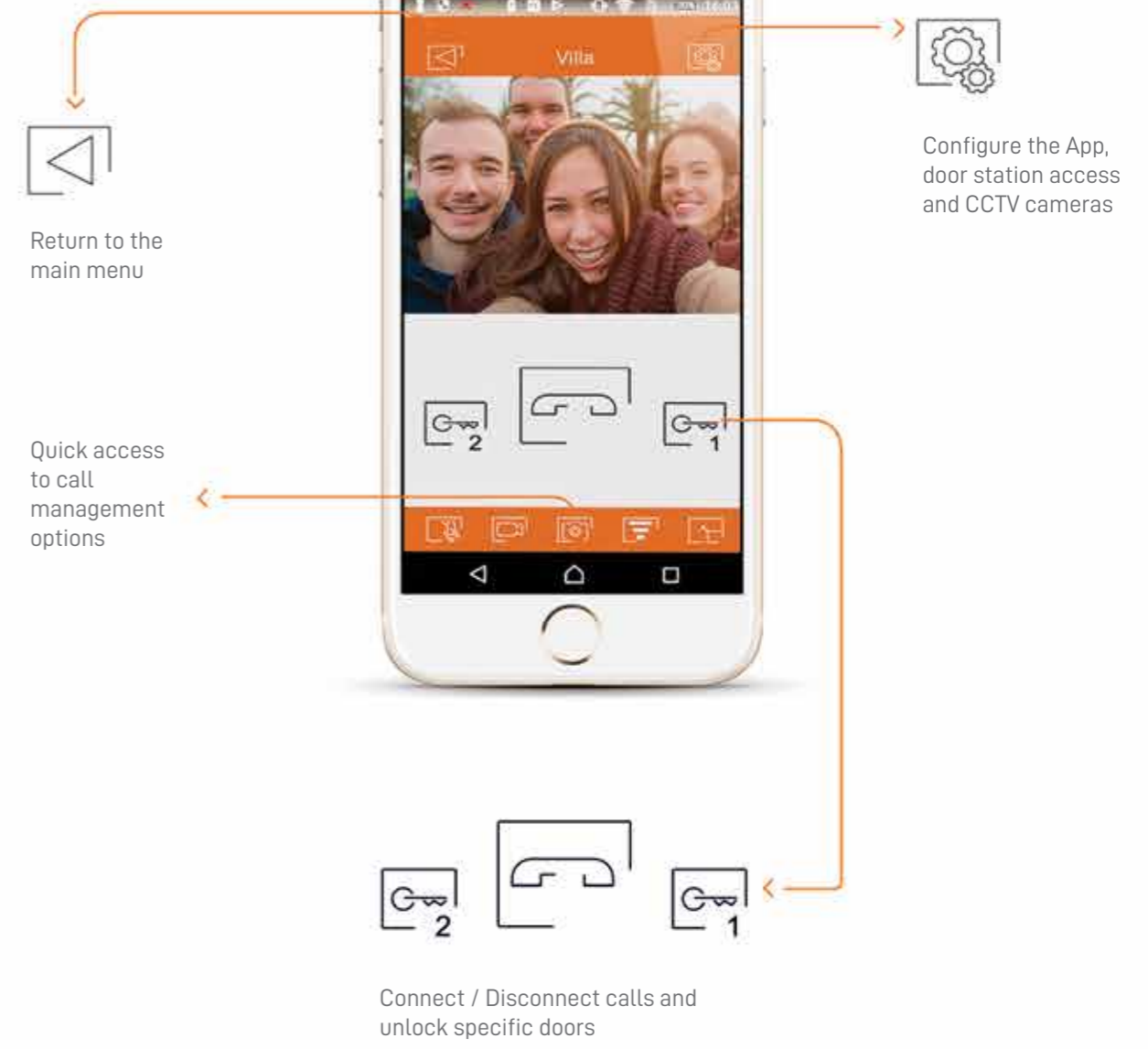

G2Call





G2Call



Make use of the G2Call app in any of your mobile devices (Android/iOS).

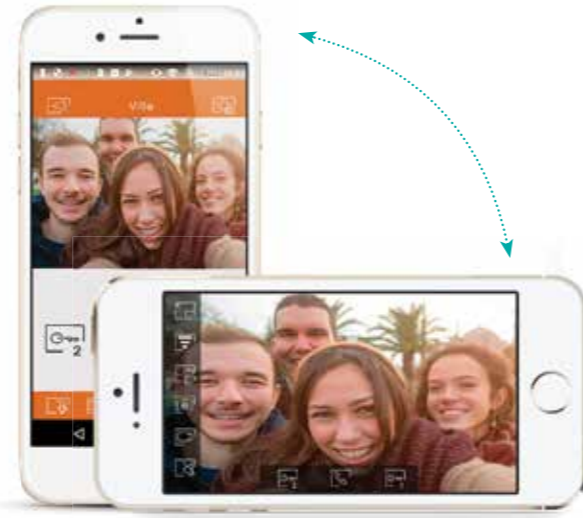

Don't lose the smallest of details, maximize the image captured by the door station.



Establish a PIN for the activation of your doors and equip your system with greater security.



Play the screenshots and / or videos stored.



Manage calls from your different facilities using the same app.



Be informed at all times of events that have taken place in the system.



Modify monitor settings, password, communication mode to "Push to talk", etc.



Modify the name of your unit, encryption for the openings, number of door stations, CCTV camera etc.

Option 1 One door station and one monitor

1x GL-SOUL 7W KIT

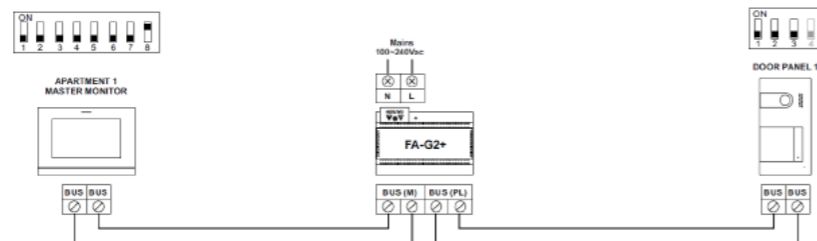

Option 2 Two door stations and one monitor

1x GL-SOUL 7W KIT

1x GL-SOUL/1

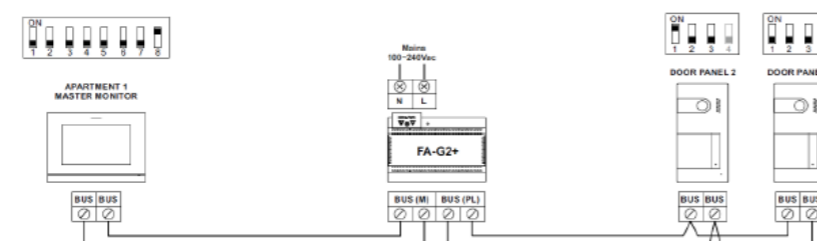

Option 3 Two door stations and up to four monitors

1x GL-SOUL 7W KIT

1x GL-SOUL/1

3x GL-ART4

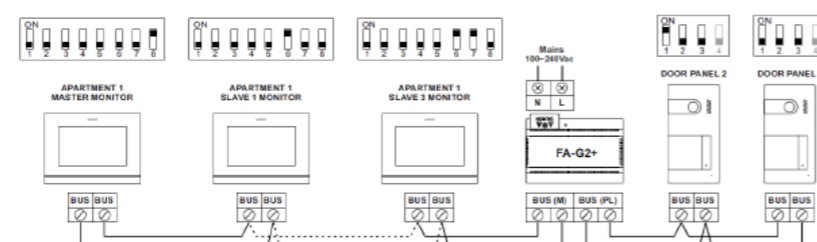

Option 4 Two door stations and up to four monitors through video distributor

1x GL-SOUL 7W KIT

1x GL-SOUL/1

3x GL-ART4

1x GL-D4L-G2+

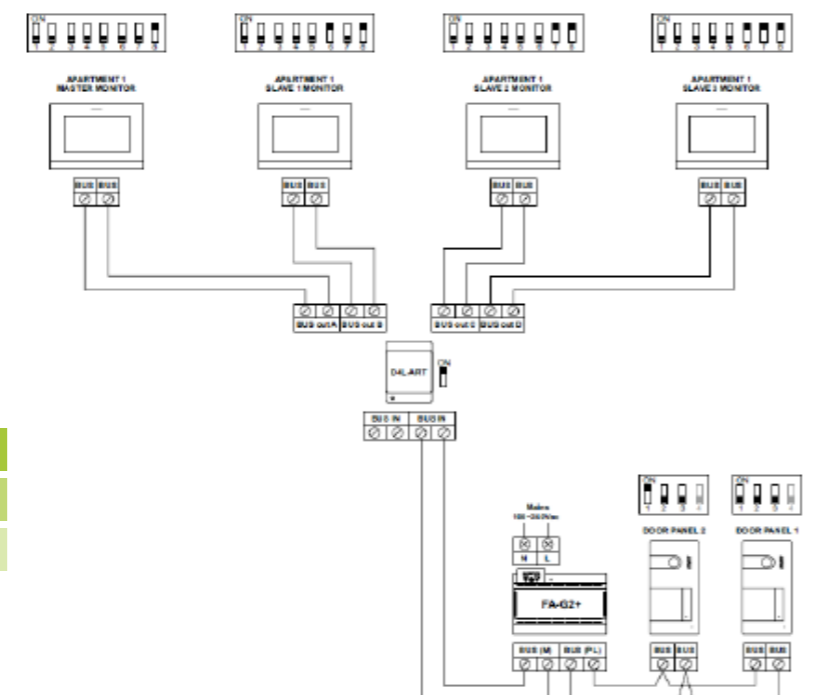

Cable Sections	Max. Distance
Door Station - Power Supply	60m
Power Supply - Monitor	60m

GL-ART4 Additional Monitor

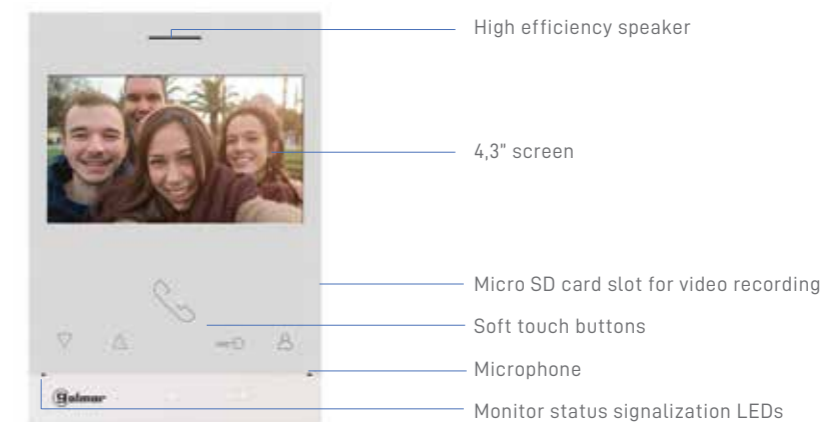

GL-SOUL/1 Door Station

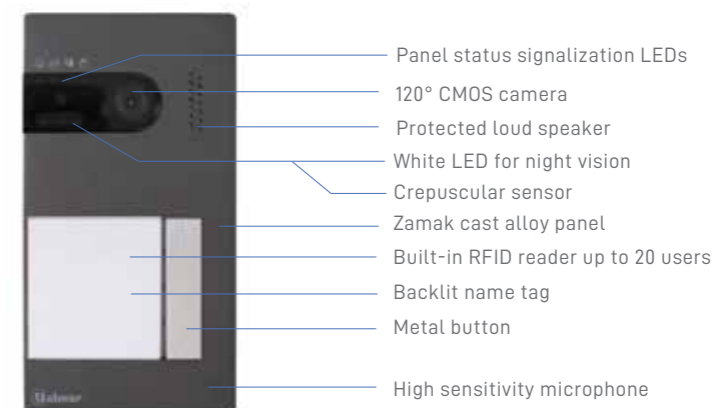

GL-TAGSET/5 User Tags

- For panels with RFID reader GL-SOUL/1
- Includes 5 user tags



GL-D4L-G2+ Optional Video Distributor

- Video distributor for SOUL 7W Kit
- 4 distributed outputs
- Use for "Star Configuration"





EOS AUSTRALIA

NSW
02 9749 5888
nsw@eos.com.au

VIC
03 9544 5633
vic@eos.com.au

QLD
07 3252 9272
qld@eos.com.au

WA
08 9249 5911
wa@eos.com.au

© 2019 EOS Australia PTY LTD.

All rights reserved. Golmar Soul Art, The Golmar logo, are the trademarks of Golmar Sistemas de Comunicación S.A. Other trademarks and trade names may be used in this document to refer to either the entities claiming the marks and names or their products. EOS Australia PTY LTD disclaims proprietary interest in the marks and names of others. This document is for informational purposes only. EOS Australia PTY LTD reserves the right to make changes without further notice to any products herein. The content provided is as is and without express or implied warranties of any kind. Golmar is exclusively distributed by EOS Australia in Australia.