



Hi mUGa Uf h K]! :]



('K ≠9 'K ≠ =

J-89C'8CCF'D<CB9'A5BI 5 @



videoman.com.au

INDOOR MONITOR

Note: The following are diagrams of all of the available indoor unit models, not all models have the same layout or features, please take actual model as quasi.

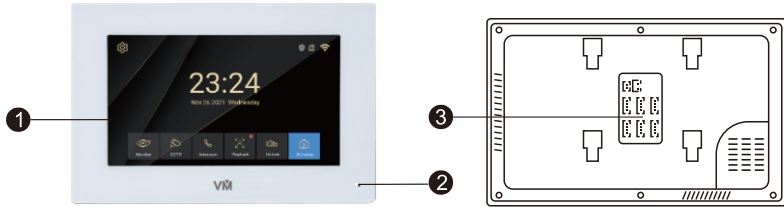

NO.	Name	Descriptions
1	TFT display	View visitor's image displayed on TFT screen
2	Microphone	Transmit the voice to door station
3	SD card slot	For the models with SD card, Insert the SD card for recording

SYSTEM INFO

- You can purchase the compatible doorstrikes from our authorized resellers.
- For the use and selection of wires, please refer to the following.(The cable quality affects video and audio quality as well as the working distance.)
 - 4C ordinary unshielded wire and shielded wiring

Distance $\leq 30\text{m}$ (RVV4*0.5mm ²);	Distance $\leq 50\text{m}$ (RVV4*0.75mm ²)
Distance $\leq 70\text{m}$ (RVV4*1.0mm ²);	Distance $\leq 100\text{m}$ (RVV4*1.5mm ²)



- Category 5 network cable connection (not recommended)



(Unshielded network cable distance ≤ 50 meters)

- Category 6 network cable connection.

Category 6 network are the same as Category 5 network, shielded network cable distance ≤ 100 meters.

Wiring Diagram



First monitor must be set as **master**. all other monitors must be set as **slave**. this can be done in the settings menu.
monitor id setting
master=01, slave=02 to 04

Note: IP Cameras are not compatible. Please use Analogue cameras.

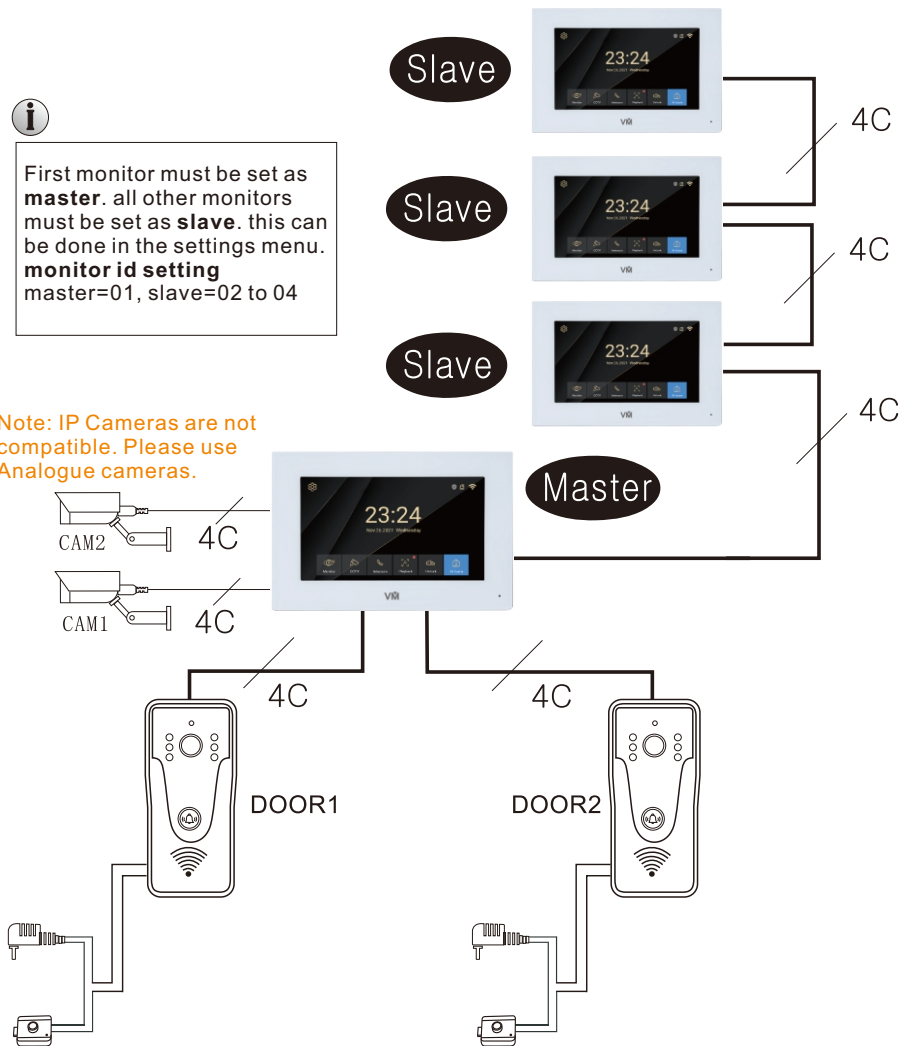

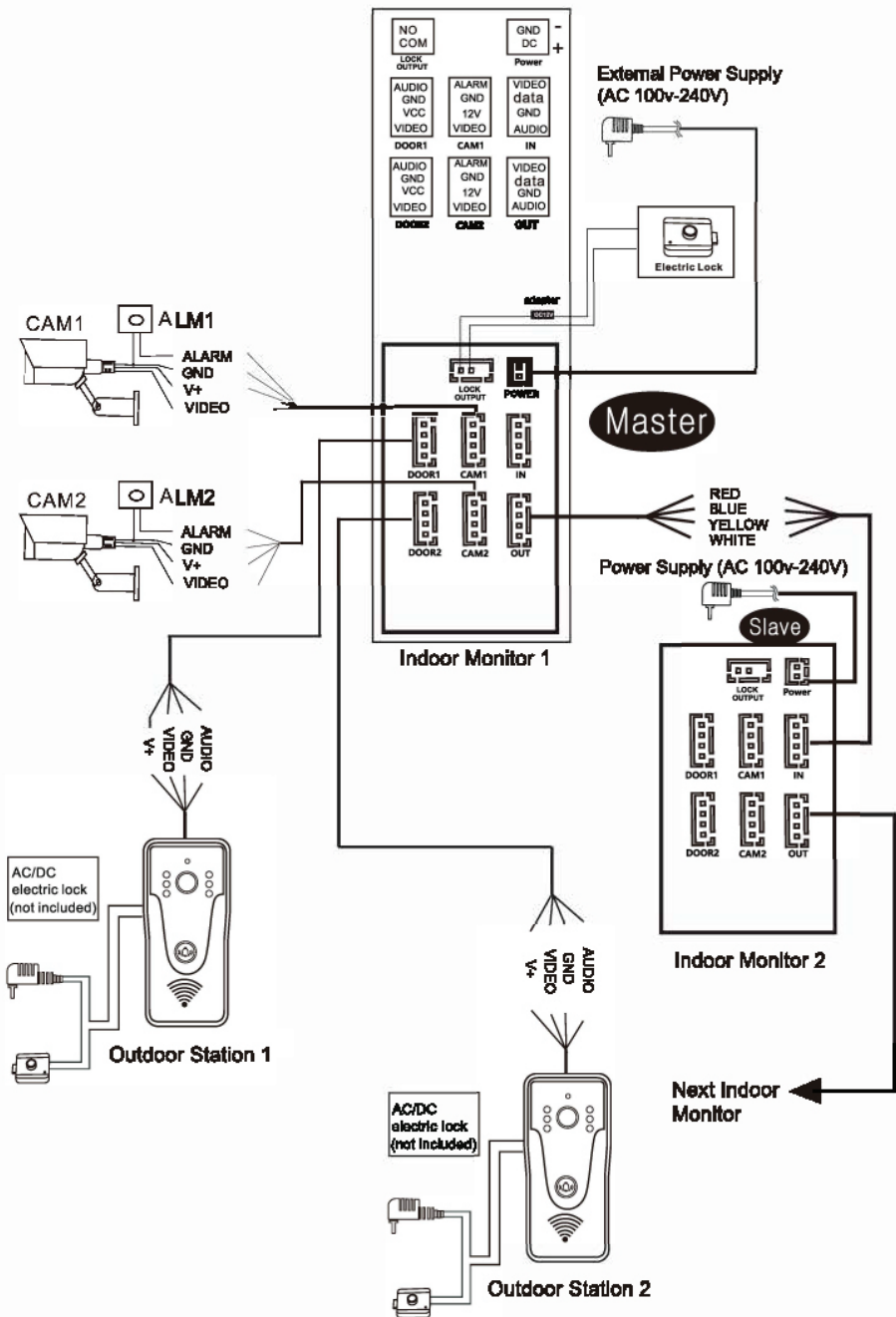

outdoor station Information

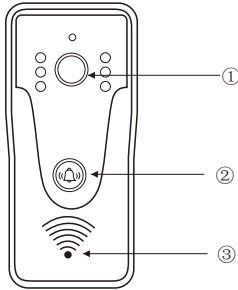

outdoor station backview

No.	Function Description
①	camera
②	call button
③	microphone

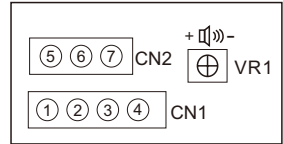

Rear view of outdoor station

► Description of the outlet of the outdoor station:

1.VIDEO(white) 2.VCC (yellow) 3.GND(blue) 4.AUDIO(red) 5.NO 6.COM 7.NC

CN1: connected to the indoor monitor.

CN2: connected to the lock. NC and COM to the magnetic lock, NO and COM to the electronic lock.

VR1: switch to adjust the volume. clockwise for down, anticlock for up.

Product Information

Indoor Monitor Feature

- | | |
|--|--|
| <ol style="list-style-type: none"> 1. System Capacity: 4 indoor monitors + 2 door stations + 2 cameras. 2. Intercom Mode: Two-way intercom, cloud intercom. 3. Function: Video communication, monitor, unlock, image memory/video record, wifi, TUYAAPP, and motion detection. 4. Resolution: 1024*600. 5. Screen: 7"/10" TFT LCD touch screen. | <ol style="list-style-type: none"> 6. Talking time: 60 seconds. 7. electric current: Standby current 130mA; working current 360mA. 8. Power supply: External power DC12-15V ; Built-in power AC180-240V. 9. Work Temperature: -10~50°C. 10. Max Capacity: 128G. |
|--|--|

Operating instructions

• MainInterfaceInstruction



- | | |
|--------------------------|-----------------------|
| ① Display door stations | ⑦ Time and Date |
| ② Display CCTV cameras | ⑧ WiFi status |
| ③ Call and communication | ⑨ SD Card status |
| ④ Playback footages | ⑩ Alarm sensor status |
| ⑤ Unlock door/gate | ⑪ Setting |
| ⑥ Mode Select | |

Operating instructions

Communication and Monitor Interface

- Click here for monitor and communication



- 1 Switch between door stations
- 2 Take snap pictures
- 3 Record video
- 4 Answer call
- 5 Unlock door/gate

- 6 Exit/Return
- 7 Time and Date
- 8 Monitor and talk time countdown
- 9 Door station ID

Operating instructions

CCTV Monitor Interface

- Click here for monitor

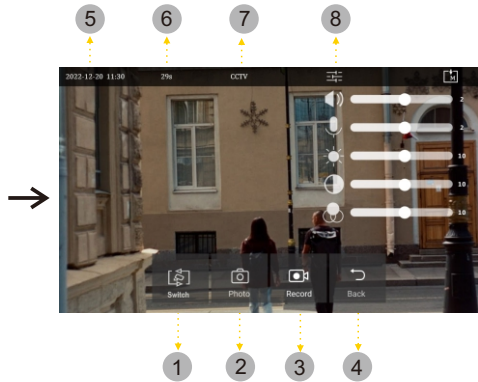

- 1 Switch between cameras
- 2 Take snap pictures
- 3 Record video
- 4 Exit/Return

- 5 Time and Date
- 6 Monitoring time countdown
- 7 Camera ID
- 8 Picture adjust

Intercom

- Call other monitors



Operating instructions

Playback

- Playback recorded images and videos

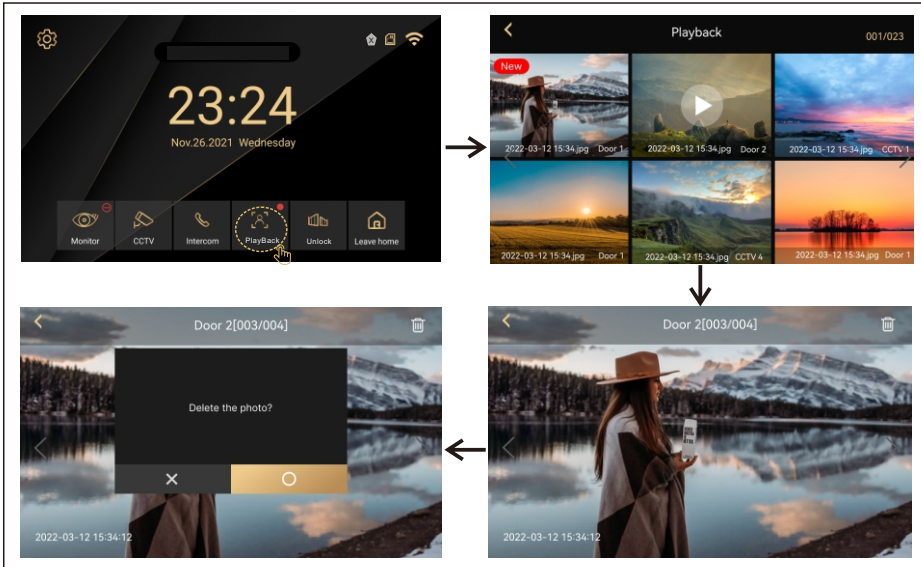

Mode(At Home, Leave Home, DND)

- At Home, Leave Home, DND



Main Interface

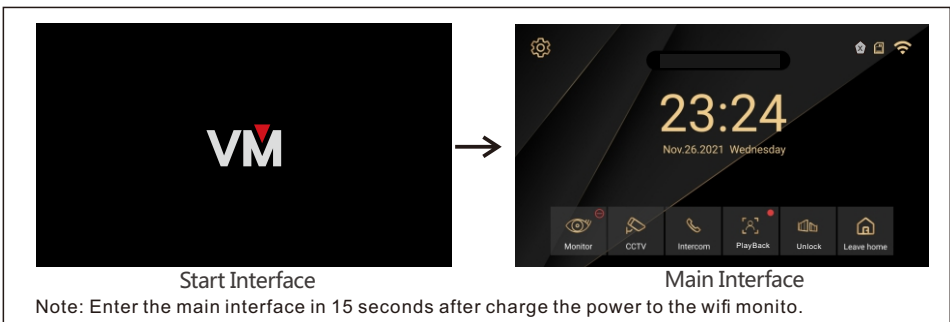

Operating instructions

Setting

- Click  to enter setting interface
Recording, Wi-Fi, Volume, Storage, Date&Time, Display, Others

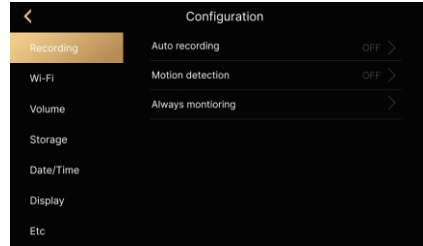
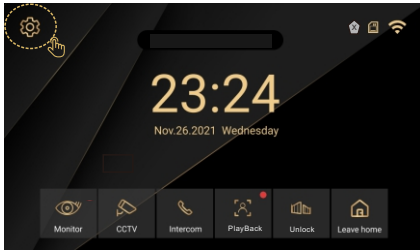

1 Recording

- Auto recording(video or photo)

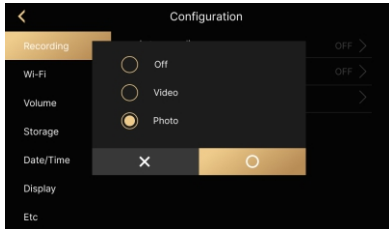

- Motion Detection

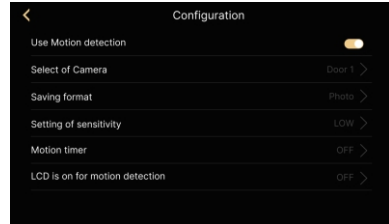

- Always monitoring(Each camera monitors the time)

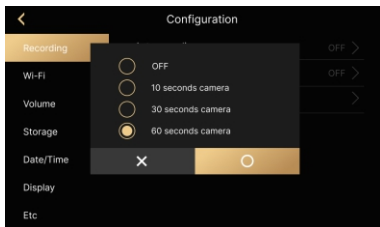

2 Wi-Fi

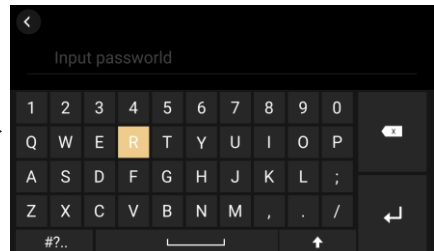
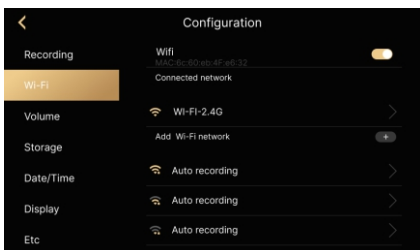

- Wifi On/off and selection.

- Input WIFI password

Operating instructions

3 Volume

- Click Volume to enter setting interface. Set the volume, ring type, and ring time.

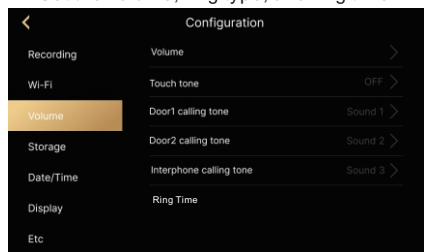

4 Storage

- Clear storage space. Format of SD card, and delete all videos or pictures.

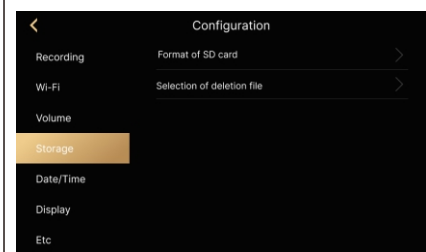

5 Date/Time

- System Time
- Sync time
Press the button, the time of device 1 can be synchronized to device 2, device 3, and device 4.

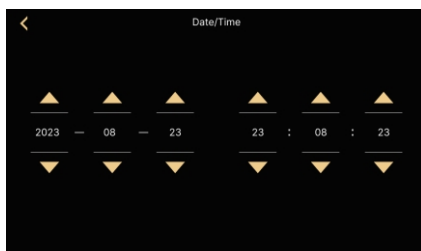

6 Display

- Standby mode or Cleaning mode or Screen brightness or Camera format setting.
- LCD OFF (The screen goes black after 30 seconds of operation).
- Lock screen wallpaper (The system comes with lock screen scrolling wallpaper).
- The system is compatible with multiple formats. Select the system format according to the camera format. If you don't know which camera format to use, select Auto Format.

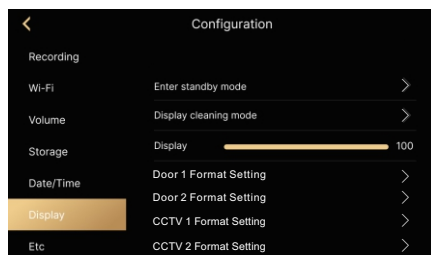

7 Others

- There are nine languages: English, Korean, Chinese, Hebrew, Russian, Spanish, Turkish, Polish, Czech, Arabic.
- Extension ID: Range from 1 to 4. 1 means the monitor is Master, 2 to 4 means the indoor monitors are slave. Each family support 4 indoor monitors maximum.
- Unlock time: The unlocking time of the outdoor station. The range is 1s-10s, and the default is 2s.
- Security password: Security alarm password. When the alarm signal is triggered, the alarm can be canceled through the password. The password can be changed.
- Security: CCTV1 and CCTV2 both have a normally closed security zone. Turn on the zone function. When the zone is in an open state, the indoor unit will give a warning.
- System reset: Indoor unit restores initialization status.
- System: Including version information, version release date, UUID, SD memory.

TUYA APP installation and connection



Mobile Phone TUYAAPP Setting, make sure the mobilephone is nearby the wifi monitor and router.

Step 1

Install the 'Tuya Smart' app on your phone from Google play Store or iOS App store. Please connect your phone to the same WiFi network as the monitor.

Step 2

"Tuya Smart" APP for adding

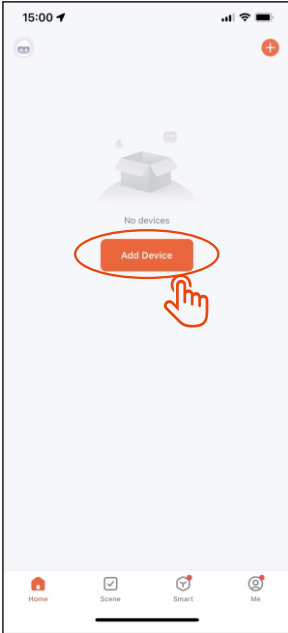

Step 3

Searching and pairing



Step 4

wifi monitor device is found and click"add"

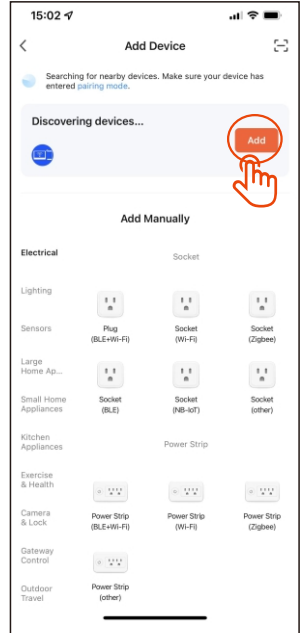

Step 5

Being added

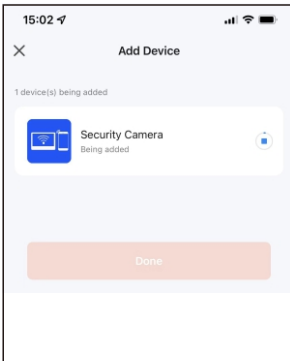

Step 6

added successfully and click "Done"

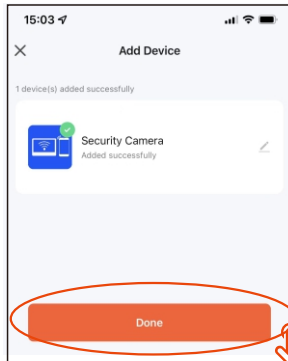

Step 7

Mode Setting after added device

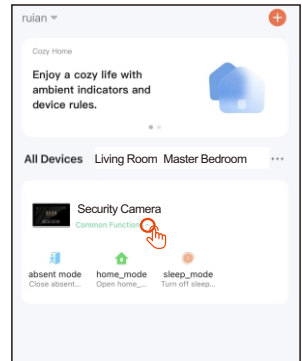

HOW TO SHARE “Tuya Smart ” TO OTHER USERS

new home members need to register the new account
follow the below steps to share.

Step 1

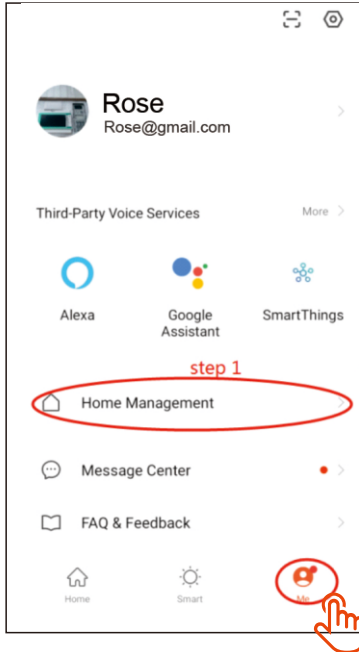

Step 2

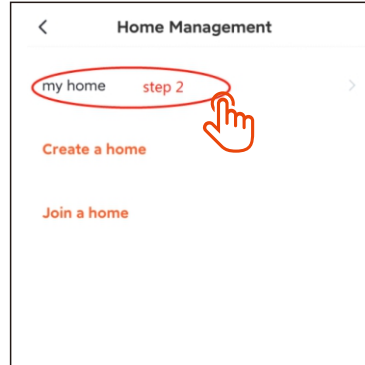

Step 4

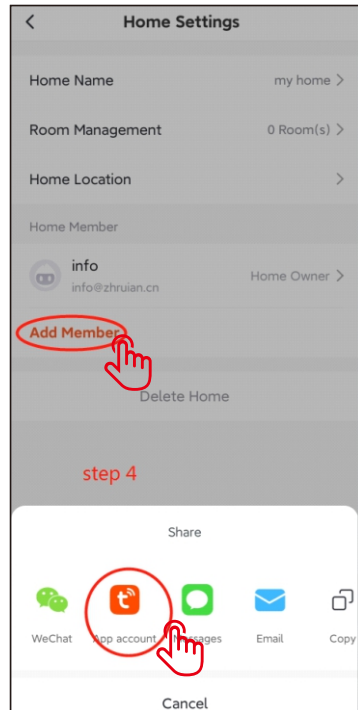

Step 3

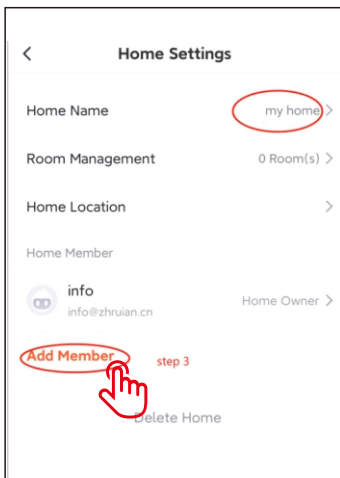

Step 5

Cancel **Add Member** Save

another registered user name

Name **gghhv**

Region **China** >

Account **+86-15217163981**

another user registration
account(phone number or email)

Only after accepting the invitation will the account owner be able to use all the functions.

Family Role **Common Member** >

Step 6

< **Home Settings**

Home Name **my home** >

Room Management **0 Room(s)** >

Home Location >

Home Member **the new member is added**

gghhv
Waiting to join...

info Home Owner >
info@zhuoian.cn

Add Member

Delete Home

Step 6 for finish adding and checking

How to Share to additional users.

Preparation: new home members need to register the new account

the steps of the share to additional users as the below.

Open the "TUYA SMART" APP on the mobile phone ----- click "me" ----- click "home management"
----- click "my home" to enter the "Home Setting" ----- click "Add Member" ----- click "App Account"
----- input the registered user name and account(email or phone number) and Save it You will find the
new additional users at the "Home Setting".

APP intercom instruction

