

# RisControl

## User Manual



**Model: RP432KPT**

# Contents

<b>INTRODUCTION</b> .....	<b>5</b>
<b>INSTALLING THE RISCONTROL</b> .....	<b>6</b>
Mounting the RisControl.....	6
RisControl Setup .....	10
Step 1: Selecting the language for the RisControl.....	10
Step 2: Setting the Bus Address (Virtual DIP Switch) .....	11
Step 3: Setting the Wi-Fi Connection (optional) .....	12
Step 4: Synchronizing the RisControl with the Security Setup.....	14
<b>OPERATING THE RISCONTROL</b> .....	<b>15</b>
Entering RisControl .....	15
RisControl Session.....	15
RisControl Main Menu .....	15
RisControl Top Bar .....	16
Troubles Management.....	19
Communication troubles .....	19
Confirm Troubles .....	21
Notifications Management .....	21
Software Update Notification .....	22
Confirm Alarms .....	22
<b>SCREEN SAVER</b> .....	<b>24</b>
Exit/Entry Screen Saver Mode .....	24
Screen Saver During Alarm .....	24
<b>LOCK SCREEN</b> .....	<b>25</b>
About the Lock Screen .....	25
Lock Screen with Quick Arm and/or Quick Stay.....	26
Lock Screen with Undefined Quick Buttons.....	27
The Lock Screen during Incoming Alarm.....	28
Blank Display Mode .....	29
<b>OVERVIEW SCREEN</b> .....	<b>30</b>
Using the Overview Screen .....	30
Empty Overview Screen .....	31
Editing the Overview Screen .....	31
Adding Shortcut Buttons to the Overview Screen .....	32
Removing Shortcut Buttons from the Overview Screen .....	34

Using the Shortcut Buttons from the Overview Screen .....	34
Incoming Alarm on the Overview Screen .....	35
<b>SECURITY .....</b>	<b>36</b>
Partitions .....	36
Arming and Disarming .....	37
Exit/Entry Delay .....	38
Final Exit Zone .....	38
One Click Activation of all Partitions .....	39
Arming/Disarming Selected or All Partitions .....	40
Groups .....	40
Detectors .....	42
Utility Outputs .....	44
<b>CAMERAS .....</b>	<b>45</b>
Cameras Screen .....	45
PIR CAM .....	46
Video Cameras .....	47
The Cameras Screen .....	48
Quick Buttons .....	49
Using Quick Buttons .....	49
Quick Buttons Tray .....	49
Editing the Quick Buttons Tray .....	49
Adding/Removing Quick Buttons from the Tray .....	50
Adding/Removing Multiple Quick Buttons to/from the Quick Buttons Tray .....	50
<b>VIDEO RECORDER .....</b>	<b>52</b>
Video Recorder Live Gallery .....	52
Camera Video Playback .....	53
Time Slider .....	54
Playback Controls .....	55
Date Selection .....	55
Switch back to Live .....	55
<b>SMART HOME .....</b>	<b>56</b>
<b>HISTORY .....</b>	<b>57</b>
Searching Events .....	57
Media Events .....	58
<b>SETTINGS .....</b>	<b>59</b>
General .....	60

Wi-Fi Connection.....	60
Screen Brightness.....	60
Session Timeout.....	61
Screen Saver.....	61
Language.....	62
System Information .....	62
Software Update .....	62
Software Version.....	62
IP Address & MAC .....	64
Security System SW Version.....	64
Security System IP Address .....	64
Users and Permission Settings .....	64
Add a User.....	65
Edit or Delete a User .....	66
Edit a User’s Own Details .....	66
Login to the RISCO Cloud .....	67
Date & Time .....	68
Date & Time Settings.....	69
Maintenance .....	69
The Maintenance Menu .....	69
Walk Test.....	70
Sounder Test .....	71
Service Mode .....	71
Anti-Code .....	72
Sounds.....	73
Follow Me .....	74
Adding a Follow Me Recipient .....	74
Test or Edit a Follow Me .....	75
Service Info .....	75
<b>EMERGENCY .....</b>	<b>77</b>
Emergency Button Position in Lock Screen/Main Menu .....	77
Emergency Type Selection .....	77
<b>SPECIFICATIONS .....</b>	<b>78</b>
RED Compliance Statement: .....	78
FCC ID:JE4RP432KPT .....	79
FCC Note .....	79

# INTRODUCTION

RisControl is a high-resolution Smart Touchscreen Keypad with an intuitive, easy to navigate user interface. RisControl combines standard keypad functionality with the ability to operate RISCO's cloud-based solutions and products, such as alarm, video and Smart Home devices, from one customizable screen.

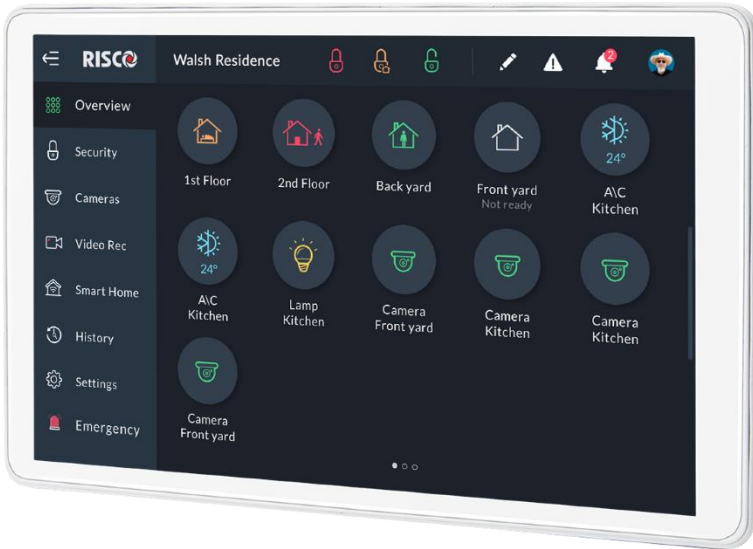


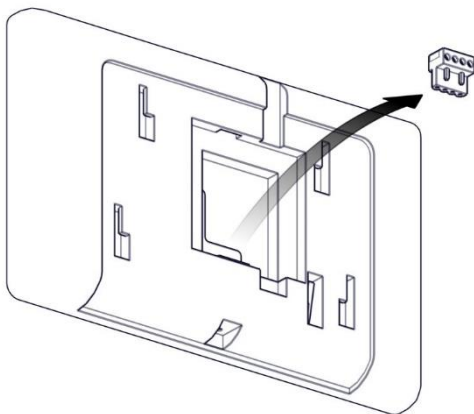
Figure 1: RisControl

# INSTALLING THE RISCONTROL

**Note:** This chapter is intended for the installer.

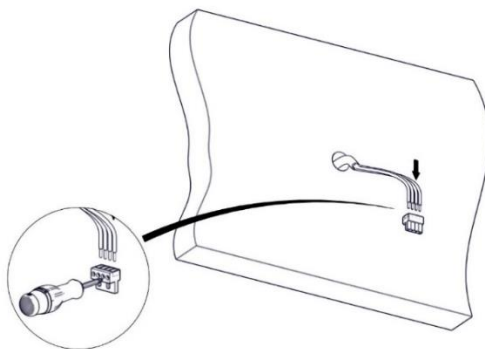
## Mounting the RisControl

1. Remove the RS 485 connector.

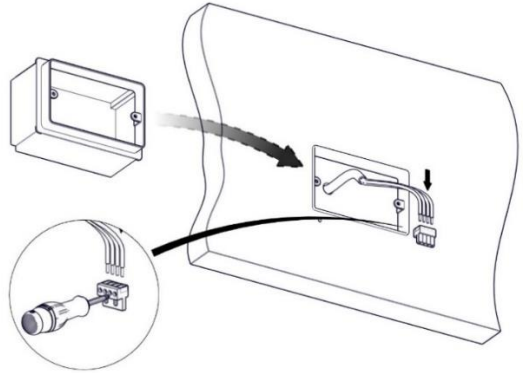


2. Insert the wires into the RS 485 connector and secure with screws.

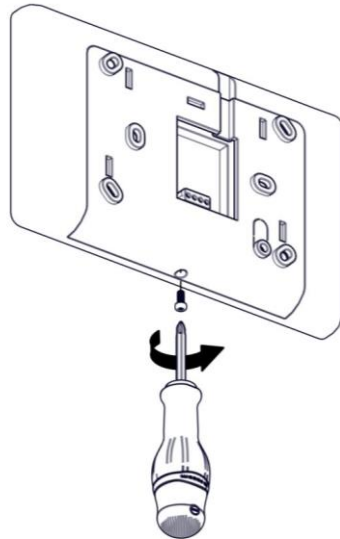
### Wall Installation



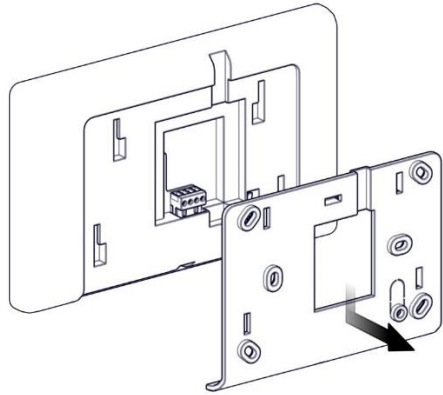
### 3 Gang Flush Mounting Box Installation



3. Remove screw to separate the bracket from the RisControl.

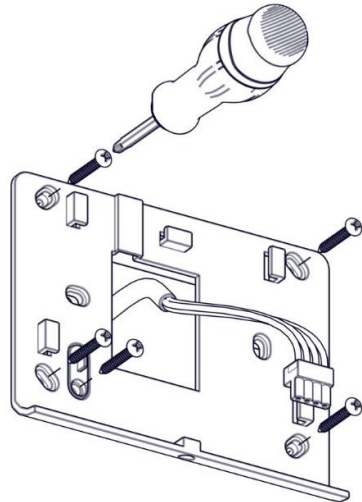


4. Push down and then outward to remove the bracket.



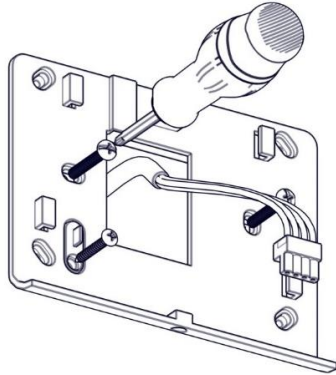
5. Position the bracket on the wall / Flush Mounting Box and secure with 5 screws including tamper (Wall installation) / 3 screws including tamper (Flush Mounting Box installation).

### Wall Installation

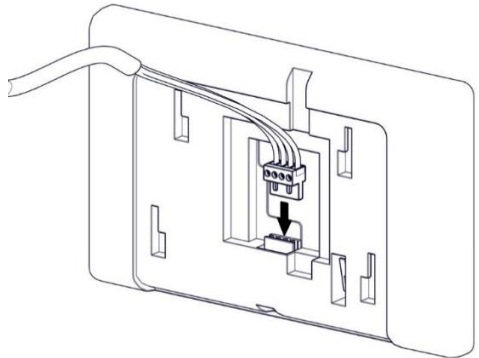




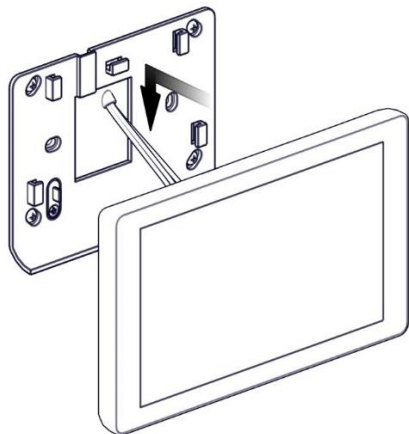
### 3 Gang Flush Mounting Box Installation

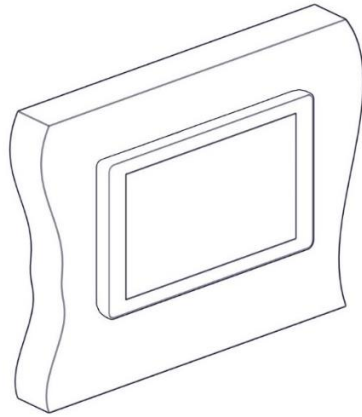


6. Insert the RS 485 connector into its location in the rear side of the RisControl.



7. Position the 4 grooves of the RisControl over the bracket's 4 pins and slide downward to secure.





## RisControl Setup

After wiring the RS-485 bus of the Security System successfully, the powerup procedure will begin automatically and shortly after the installer will be able to perform the RisControl setup.

The following workflow illustrates the recommended method for setting up the RisControl.

- **Step 1:** Selecting the language for the RisControl
- **Step 2:** Setting the Bus Address (Virtual DIP Switch)
- **Step 3:** Setting the Wi-Fi connection – for connecting the RisControl to the RISCO Cloud (optional)
- **Step 4:** Synchronizing the RisControl with the Security Setup

### Step 1: Selecting the language for the RisControl

When the "Welcome" screen is displayed, select the preferred language that will be used in the RisControl screens.

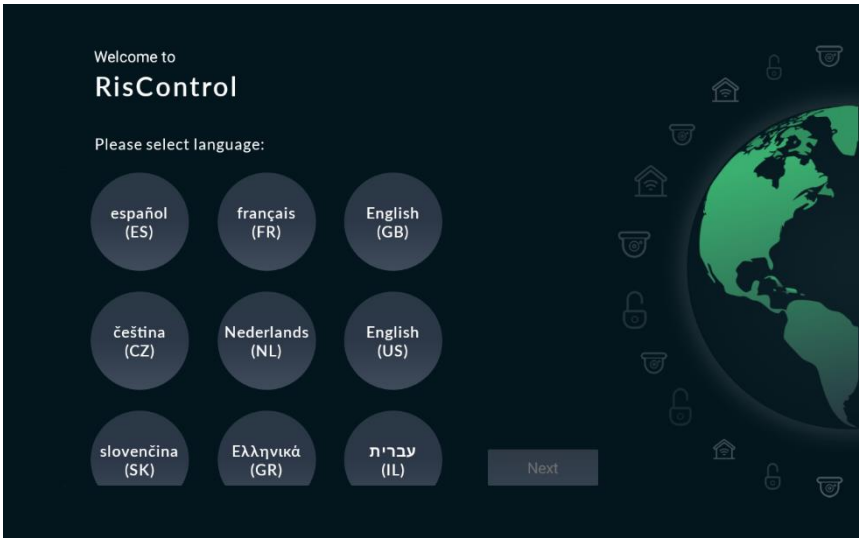


Figure 2: Welcome Screen

## Step 2: Setting the Bus Address (Virtual DIP Switch)

1. Set the virtual toggle switches on the screen below to indicate the BUS address of the RisControl. For detailed instructions, refer to your receiver's installation manual, Setting BUS Accessories ID Numbers section.

**Note:** The RisControl will not communicate by BUS until prompted by the panel following the "Scan for devices" procedure that the installer initiates from the panel.

2. Following address setup of the RisControl, click "Next".

**Note:** The setup procedure will continue in parallel with the time it takes for the RisControl to be added to the Security System (that has not yet "discovered" the other RisControl on the bus).

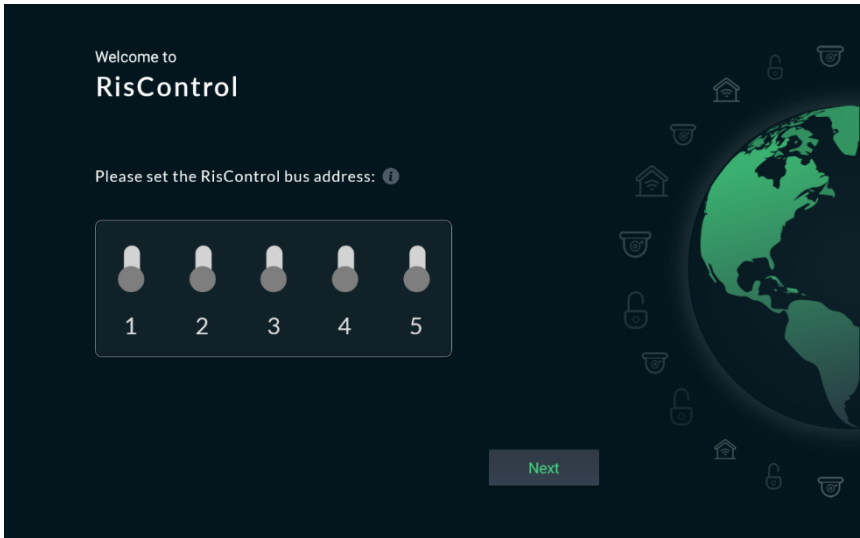


Figure 3: Bus Address Setting

### Step 3: Setting the Wi-Fi Connection (optional)

The RisControl can be connected to the RISCO Cloud via Wi-Fi.

**Note:** The connection to the Wi-Fi can also be performed by the end-user at a later time.

1. From the screen that appears, select a Wi-Fi network from the list.

**Note:** If RISCO Cloud connection is not required, click the "Skip" button.

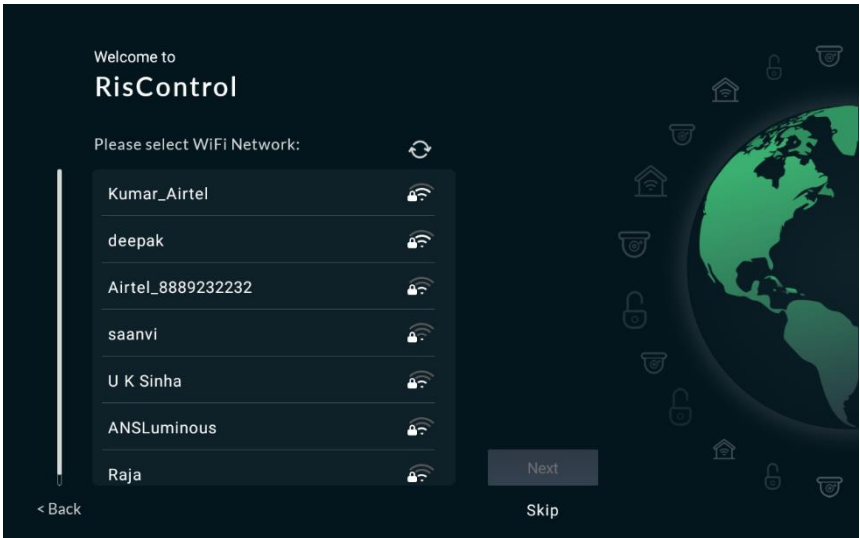


Figure 4: Selecting a Wi-Fi Network

2. Enter a password, to ensure Wi-Fi security

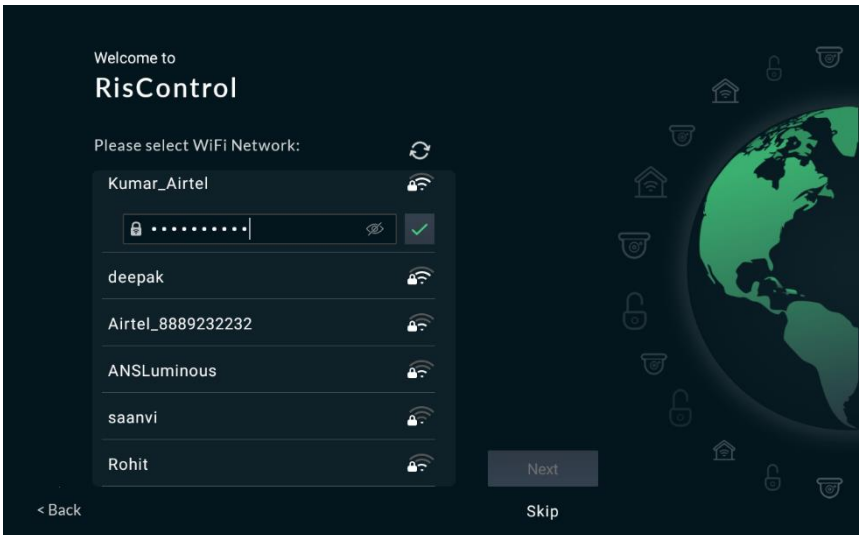


Figure 5: Enter Password

After the RisControl is connected to the router successfully and with the router connected to the Internet, the RisControl will be now connected to the RISCO Cloud.

#### Step 4: Synchronizing the RisControl with the Security Setup

Following setup of the Bus Address (Step 2) and before the setup procedure is completed successfully, the installer must use the Configuration Software (CS) or a regular keypad to command the Security System to scan the RS-485 bus for new devices to allow the RisControl to connect to the Security System and begin synchronization.

During synchronization of the RisControl and the Security System, the Security System downloads to the RisControl all pertinent information (such as Users, Permissions, Partitions). RisControl will display the following screen.

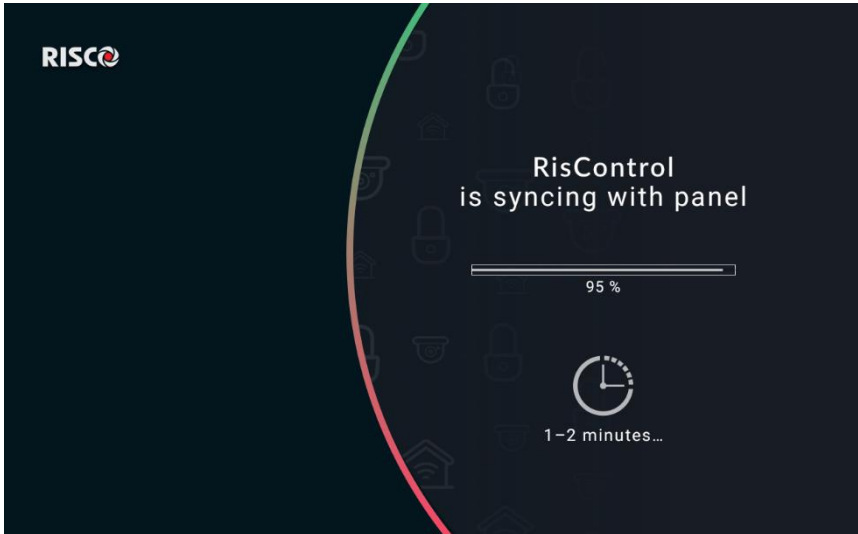


Figure 6: RisControl synchronizing with the Security System

# OPERATING THE RISCONTROL

## Entering RisControl

The RisControl operates most of the time in “Screen Saver” mode (see SCREEN SAVER, page 24). When the user can clicks anywhere on the screen, the RisControl will exit the Screen Saver mode and switch to the “Lock Screen” (page 25).

To unlock the “Lock Screen”, the user must type a valid PIN Code. Once the lock screen is unlocked, the “Overview Screen” (page 30) will be displayed allowing the user to access all the information within the defined permissions for that user, and to perform all the activities that the user level allows.



Figure 7: Various RisControl Screens

## RisControl Session

The “RisControl Session” is the period of time that the RisControl remains in the unlocked mode. It starts after a user enters a valid PIN Code, and it ends automatically following a predefined “idle” time (Session Timeout) during which the screen has not been touched. “Session Timeout” is defined in “Settings” (page 59).

The RisControl will automatically lock following the Session Timeout, during which the screen has not been touched.

## RisControl Main Menu

The RisControl main menu, on the left side of the screen, allows the user to navigate the various menus, as required.

The main menu is always displayed on the screen and the user can decide to use the expanded mode, where the text description of each menu appears next to the menu icon, or, in its collapsed mode, where only the icons of the menus appear.

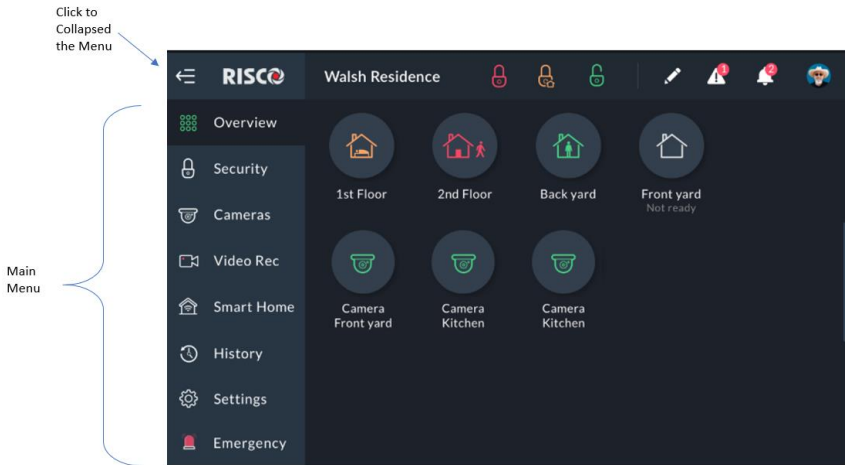


Figure 8: Main Menu (expanded mode)

The user can use the  button, at the top left corner of the screen, to change the menu mode of display. Here is how it looks when the display is collapsed:

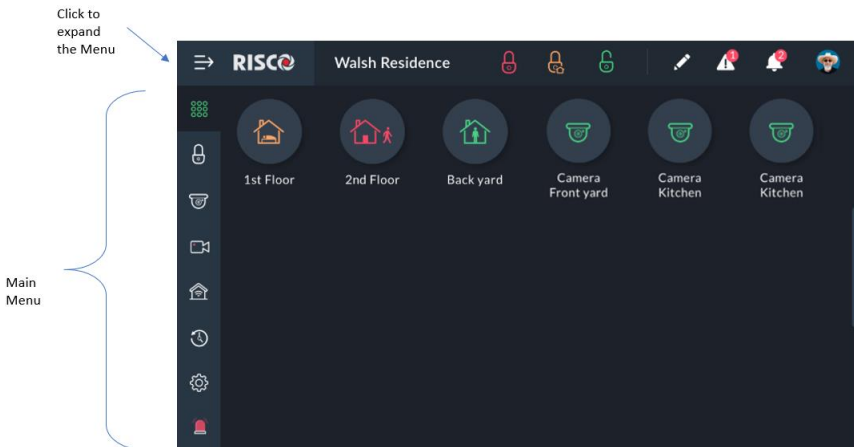


Figure 9: Main Menu (collapsed mode)

## RisControl Top Bar

The “RisControl Top Bar” appears at the top of numerous RisControl Screens with slight variations from screen to screen but with common elements in many of them.



Figure 10: Top Bar of the Opening Screen





## The End-User's Avatar

The End-User's Avatar appears at the top bar of all the screens.

Each user can select his own avatar as described in "Users and Permission Settings", "

Add a User” section (page 65).

**Manual termination of the RisControl Session** - If the End-User wishes to manually lock his open RISCO Cloud Session (to prevent the open screen of the RisControl from being used by an unauthorized user) the user can click the avatar and then click “Lock Screen”.

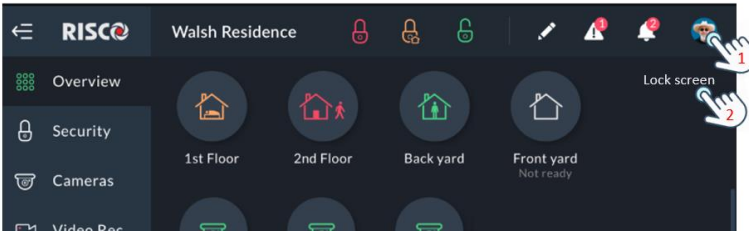


Figure 11: Manual Locking of the RisControl Session



- **Arm/Partial Arm/Disarm buttons**


These buttons appear both in the “Overview” and in the “Security” Top Bar. When clicked, they will Arm, Partial Arm or Disarm all the partitions that are associated with the user that is currently logged in.



- **Trouble and Notifications icons**

These icons will appear whenever there are one or more troubles or Notifications in the RisControl. Once displayed, they will appear in any of the menu screens.

# Troubles Management

Click the Trouble icon  in the Top Bar of the RISCO Cloud to open a list of all the Troubles that exist in the system, as show in the example below.

**Note:** The Trouble icon will appear only when there are Trouble messages.

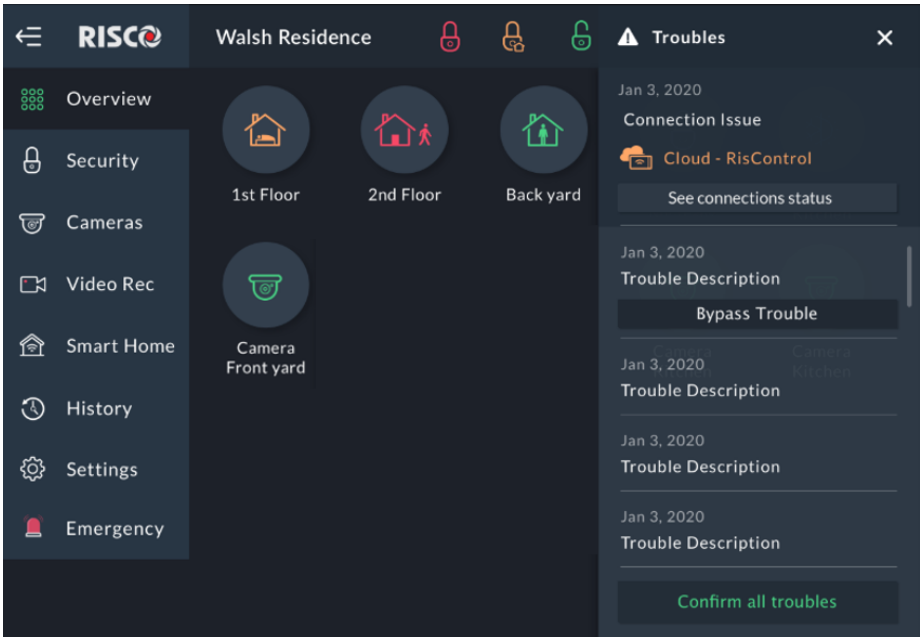


Figure 12: Troubles List

## Communication troubles

The communication Troubles are applicable to the following connections:

- RisControl to RISCO Cloud
- RisControl to Security Panel
- Security Panel to RISCO Cloud

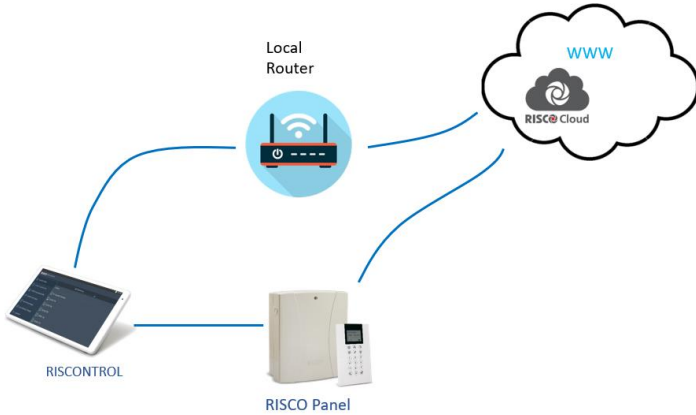


Figure 13: Communication Troubles Flow

Troubles related to communication failure will be listed first and pinned to the top of the list.

Click the “See connection status” button in the Troubles List; a popup is displayed, indicating the status of each of the connections.

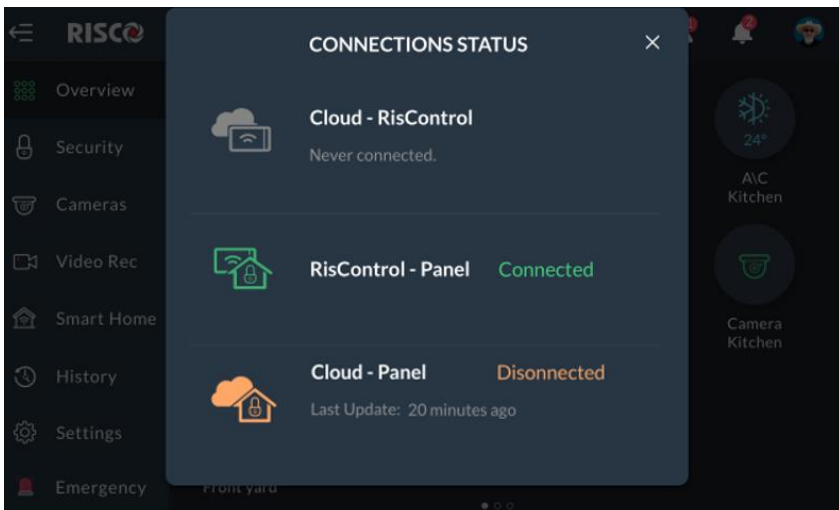


Figure 14: Communication Troubles Screen

## Confirm Troubles

**Note:** This section is applicable only to Grade-2 and Grade-3 installations. Users of lower grade installations can skip to the next section.

Some of the troubles in Grade-2 and Grade-3 installations must be “confirmed” by the user. When such troubles exist in the system, the “Confirm all troubles” button will appear at the bottom of the trouble list.

1. Click the “Confirm all troubles” button in the Troubles List.

**Note:** By clicking the “Confirm all troubles” button, the user declares that he has seen and understood the meaning of all the troubles. A series of screens will be displayed, concluding with the removal of the troubles (that require confirmation) from the list. However, only troubles that have been restored can be confirmed. For example, a Battery Low trouble cannot be confirmed before the battery is replaced with a good one (and the “Battery Low Restored” flag is set in the system).

The following popup message will be displayed.

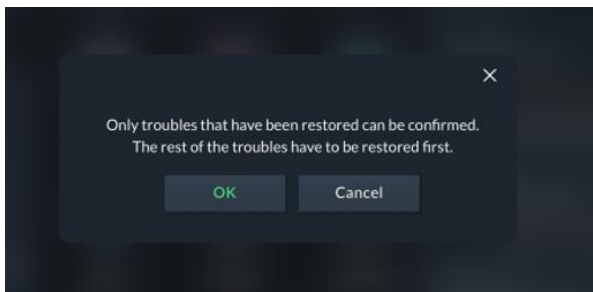


Figure 15: Confirm Troubles

2. Click the “OK” button.

All restored troubles will disappear from the Trouble List. The other troubles will remain in the list.

## Notifications Management

Click the Notifications icon  in the Top Bar of the RisControl to open a list of all the notifications that are applicable to the RisControl, as shown in the example below.

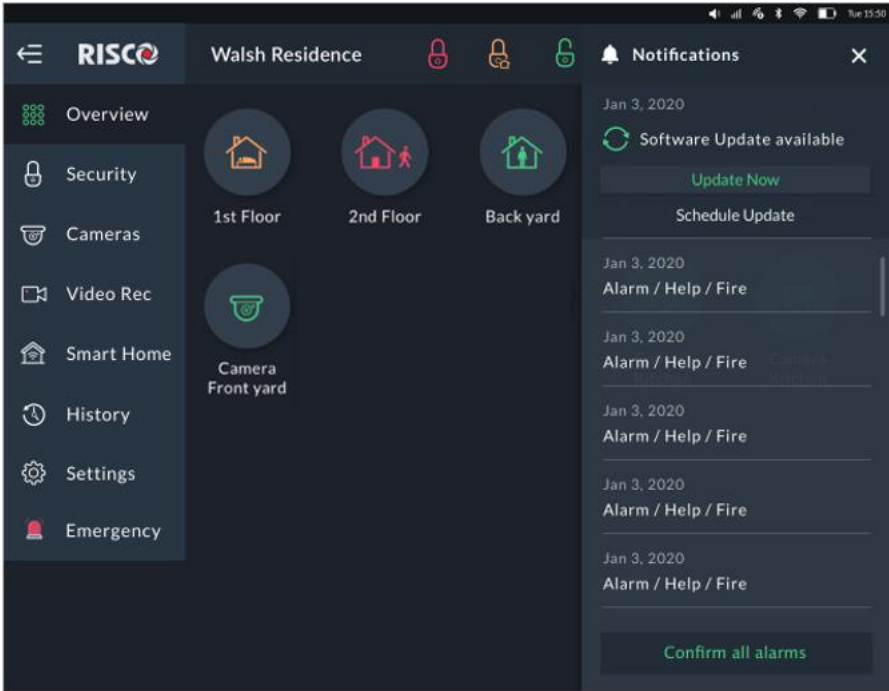


Figure 16: Notification List

## Software Update Notification

Whenever a Software Update is available, it will be pinned to the top of the list. The user can click the “Update Now” button to start the process or click the “Schedule Update” button for future update.

**Note:** This procedure is similar to the one described in “System Information” (page 62).

## Confirm Alarms

**Note:** This section is applicable only to Grade-2 and Grade-3 installations. Users of lower grade installations can skip to the next section.

Some of the alarms in Grade-2 and Grade-3 installations must be “confirmed” by the user. In this case, the “Confirm all alarms” button will appear at the bottom of the alarm list.

1. Click the “Confirm all alarms” button.

**Note:** By clicking the “Confirm all alarms” button, the user declares that he has seen and understood the meaning of all the alarms.

The following popup message will be displayed.

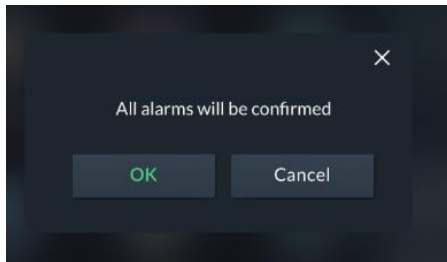


Figure 17: Confirmed Alarms Screen

2. Click the "OK" button, to approve the confirmation or "Cancel" to cancel it.

## SCREEN SAVER

The RisControl enters Screen Saver mode after a period of at least 45 seconds in which the screen has not been touched. In this case, RisControl will displays one of a variety of screens that is selected by the Grand Master (see page 61).

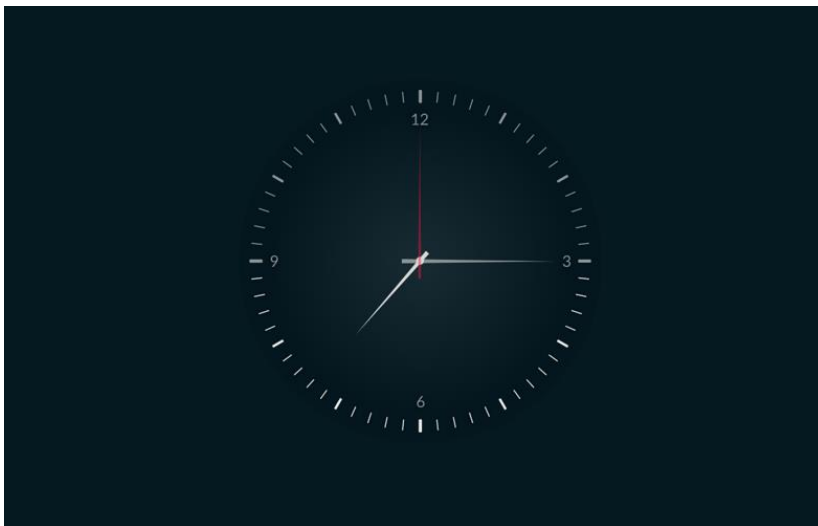


Figure 18: Screen Saver

### Exit/Entry Screen Saver Mode

To exit the Screen Saver mode, simply touch the screen. The RisControl will switch to the “Lock Screen”.

The RisControl will switch back to the Screen Saver mode after 45 seconds from the time the Lock Screen is displayed and during which the screen has not been touched.

### Screen Saver During Alarm

Following an alarm that has been triggered in the system, the RisControl will exit the Screen Saver mode and will return to the Screen Saver mode only after the alarm is reset.

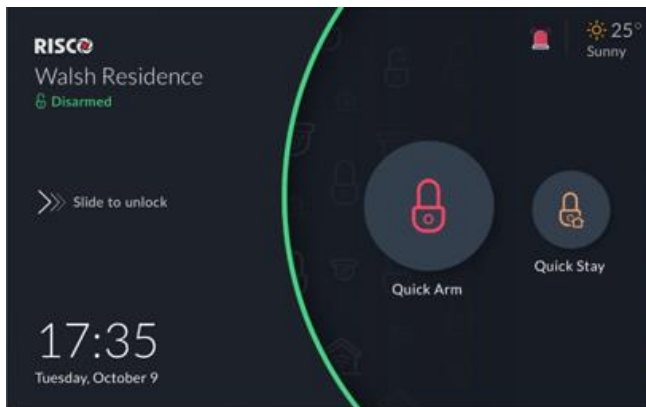


# LOCK SCREEN

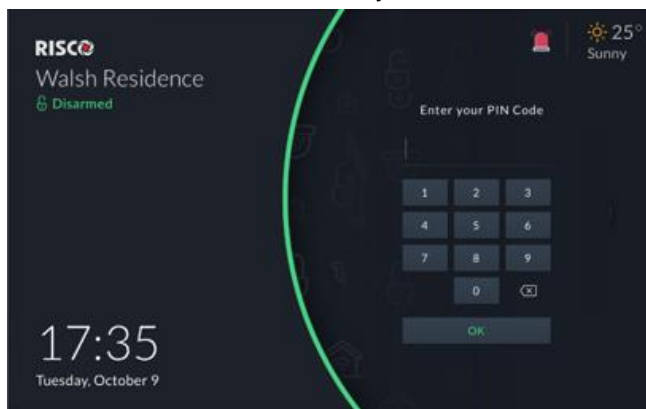
## About the Lock Screen

The RisControl Lock Screen is the screen that the user sees following a predefined time period during which the screen has not been touched. The Lock Screen is to ensure that a user who has entered the RisControl with the PIN Code, does not make the RisControl available to unauthorized people.

The Lock screen appears in one of the following two formats:



The partition that the RisControl is assigned to is defined with Quick Arm and/or Quick Stay.



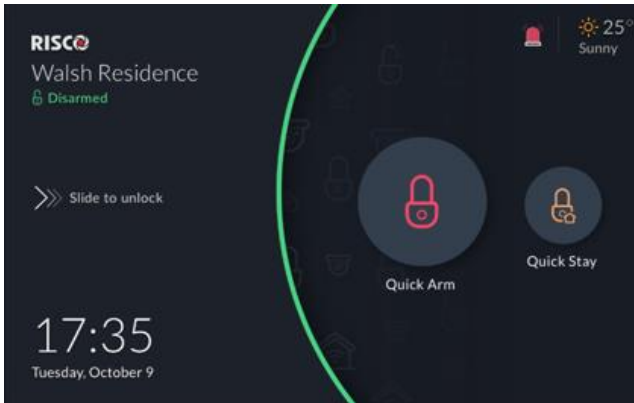
The partition that the RisControl is assigned to is defined without Quick Arm and/or Quick Stay.

Figure 19: Lock Screens

## Lock Screen with Quick Arm and/or Quick Stay

The RisControl is always assigned to only one partition and can also be masked to other partitions, via the Installer Programming of the Security System.

The partition that is assigned to the RisControl can be set (via the Installer Programming Menu) to allow Quick Arm and/or Quick Stay. The Lock Screen displays Quick Arm and/or Quick Stay icons that indicate when they are enabled, allowing anyone to directly arm the system from the Lock Screen without having to enter a PIN Code.



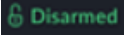
The partition that the RisControl is assigned to is defined **with** Quick Arm and/or Quick Stay.

Figure 20: Lock Screens with Quick Arm and/or Quick Stay

**Note:** If “Multiview” is defined in the system, the Multiview screen containing all partitions that are assigned to RisControl will be displayed as shown below.

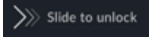



Figure 21: Multiview Screen

**RisControl's Assigned Partition Status** - Assigned Partition status is always indicated at the top left corner of the Lock Screen  and by the color of the arc at the middle of the Lock Screen, as follows:

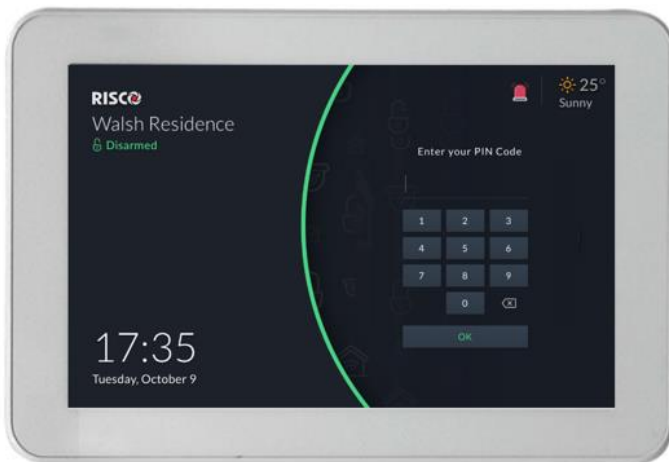
- **Green** – assigned partition is disarmed
- **Orange** – assigned partition is in Stay Mode
- **Red** – assigned partition is armed

**User's functionalities in the Lock Screen** – User can perform any of the following functionalities in the Lock Screen:

- **Click the "Quick Arm" or "Quick Stay" button** – this will immediately arm (full arm or stay arm) the partition that the RisControl is assigned to, without having to enter a PIN Code. If the partition is set with an "Exit delay", then the progress of the Exit Delay timer will be indicated on the lock screen.
- **Click the "Quick Stay" button** - this will immediately arm the partition that the RisControl is assigned to, without having to enter a PIN Code.
- **Slide to unlock** –  - the user can slide the Lock Screen from left to right to open the Keypad and then enter a PIN Code to unlock the RisControl.
- **Emergency** – The user can click the Emergency button , at the top right corner of the Lock Screen, to initiate an emergency related call, as described in EMERGENCY, page 77.

## Lock Screen with Undefined Quick Buttons

When the partition that RisControl is assigned to is not set to Quick Arm and/or Quick Stay, the Lock Screen will be displayed as shown below.



The partition that the RisControl belongs to is defined **without** Quick Arm and/or Quick Stay

Figure 22: Quick Buttons not Defined in Lock Screen

In this state, the user can enter the PIN Code only to unlock and enter the RisControl and to click the Emergency button, in case of emergency.

## The Lock Screen during Incoming Alarm

While in Lock Screen and when there is an alarm assigned to one or more partitions in RisControl, the Lock Screen will change to the following screen.

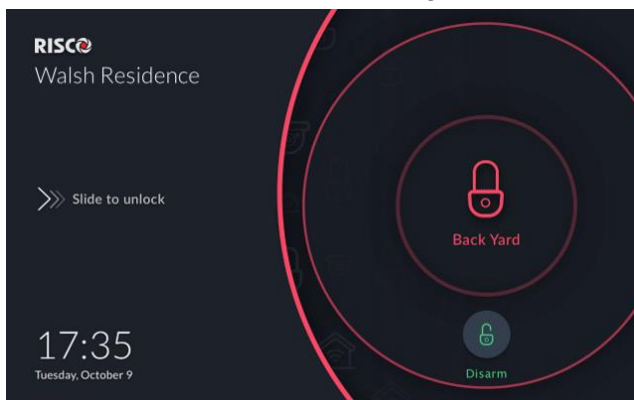


Figure 23: Incoming Alarm in Lock Screen

The Alarm indication will be accompanied with a beep sound. The user can either click the “Disarm” button (the user will then be required to enter a valid PIN Code) and will then enter the RisControl.

The user can also enter the RisControl while the alarm is activated by using the “Slide to unlock”. The user can then disarm the alarm or perform usual operations.

## Blank Display Mode

**Note:** This section is applicable only to Security Systems in installations that must comply with European Norms (EN).

When the Blank Display is enabled in the Security System (i.e., EN Standard Installation), Quick Arm and Quick Stay are disabled (since the standard does not allow their use) and the Lock Screen will be displayed, as follows.

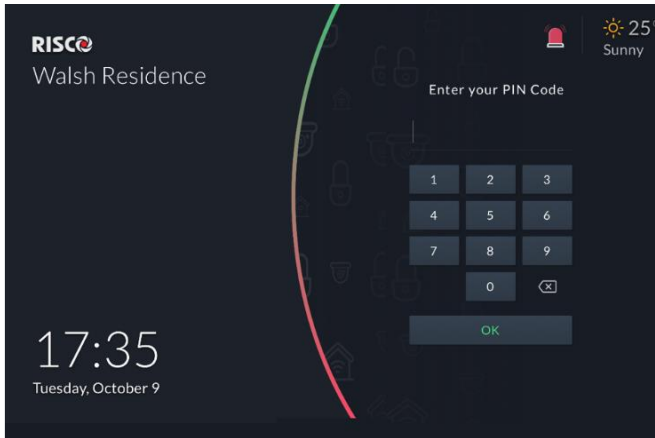


Figure 24: Lock Screen – Blank Display Mode

### Notes:

- Partition Status is not displayed
- The vertical arc consists of red, orange and green colors (provides no indication of the RisControl’s partition status)
- The user must enter the PIN Code to unlock the screen

# OVERVIEW SCREEN

A practical and time-saving feature of the RisControl is the Overview Screen. The Overview Screen allows each RisControl user to set shortcuts to all frequently used or favorite activities in one screen, without having to navigate multiple screens to access them.

## Using the Overview Screen

When the user unlocks the RisControl with the PIN Code, the Overview Screen opens, as shown below.

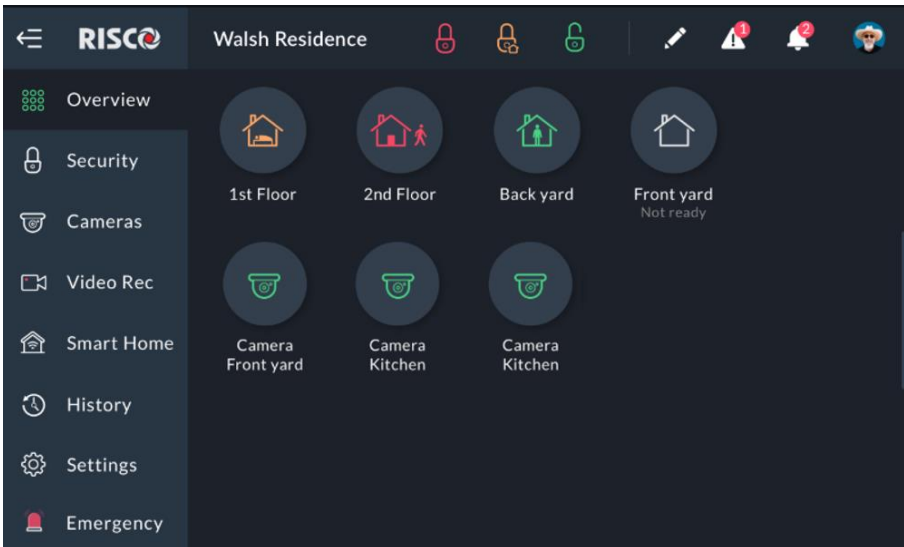


Figure 25: Overview Screen

The shortcut buttons in the Overview screen are those selected by the user and are used as shortcuts for frequently performed activities:

- You can click any of the buttons on the Overview Screen
- You can click Partition buttons to arm/disarm the corresponding partition
- You can click Camera buttons to open the camera view screen
- You can click the Utility Outputs shortcuts to activate the operation of their corresponding Utility Outputs.

**Note:** The Partitions shortcut buttons indicate the status of the partitions, using colors and texts, as described in “Security” (see page 36).

## Empty Overview Screen

When a user unlocks the RisControl Lock Screen for the first time, by entering a valid PIN Code, an empty Overview Screen (one that does not have any shortcut buttons) is displayed, as shown below.

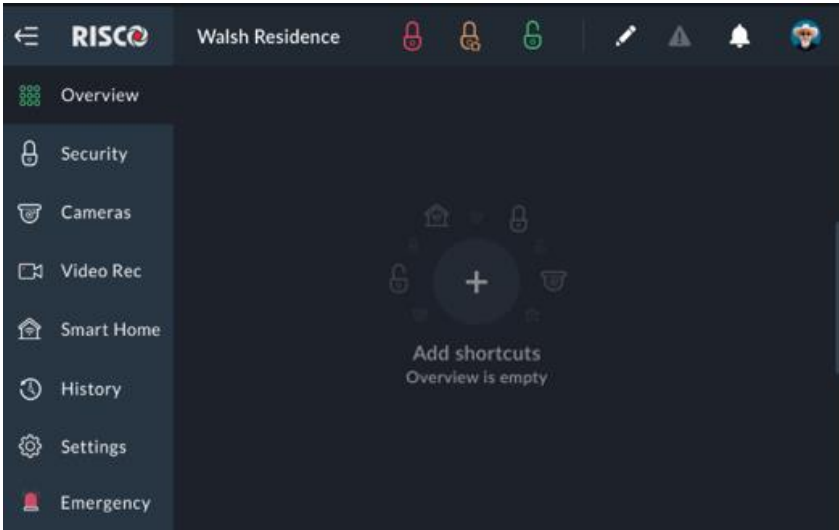


Figure 26: Empty Overview Screen

The user may want to leave the Overview Screen empty and not use the shortcuts. In this case, the user can click any of the other items in the main menu.

**Note:** If the Overview Screen is left empty, this screen will no longer be displayed, and the user will be automatically directed (upon unlocking of the RisControl) to the Security Screen.

## Editing the Overview Screen

A user can edit the Overview Screen.


Click the pencil button at the top of the screen ; the Overview Screen in edit mode, is displayed.



Figure 27: Overview Screen – Edit Mode

### Adding Shortcut Buttons to the Overview Screen

The user can add shortcut buttons to the Overview screen.

**Note:** An Overview Screen that has at least one shortcut button will be the default screen that is displayed upon each unlocking of the RisControl.

1. Click the  **Add new button**, the “Add Buttons to Overview Screen” will be displayed.

**Note:** The user can return to the empty Overview Screen, at any time, by clicking “Overview” in the main menu.



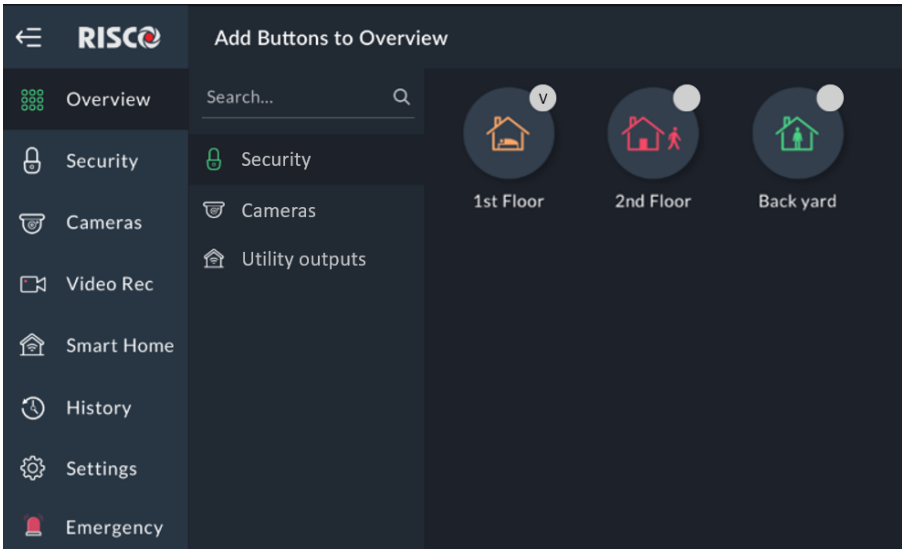



Figure 28: Overview Screen – Adding Shortcut Buttons


This screen is divided into the following side tabs:

- Security
- Cameras
- Utility Outputs



### Adding Cameras to the Overview Screen

1. Click the  **Cameras** side tab to open the list of cameras.
2. Click the bubble icons of the cameras that you wish to add to the Overview Screen.

### Adding Utility Outputs to the Overview Screen

1. Click the  **Utility outputs** side tab to open the list of Utility Outputs.
2. Click the bubble icons of the Utility Outputs that you wish to add to the Overview Screen.

### Partitions in the Overview Screen

-  A partition with a “V” inside a bubble icon will be added to the Overview screen
-  A partition with a blank bubble icon will not be added to the Overview screen

**Note:** The user can click the bubble icons of Partitions, Cameras and Utility Outputs to be added to his Overview Screen. These selections are personal and will be displayed on the Overview screen upon each entry of the RisControl and independent of the selection and preferences of the other users of the same RisControl.

### **Removing Shortcut Buttons from the Overview Screen**

Click any of the shortcut buttons with an “x” inside the bubble icon; the shortcut button is removed from the Overview Screen.

### **Using the Shortcut Buttons from the Overview Screen**

Using shortcut buttons from the Overview Screen is similar to using the corresponding buttons in the Security and Cameras Screens (see SECURITY, page 36, and CAMERAS, page 45).

## Incoming Alarm on the Overview Screen

If an alarm is initiated in any of the partitions assigned to the RisControl (and that are associated with the user that is currently logged in), the alarm will appear as a floating button at the bottom right of the Overview Screen, as shown below.

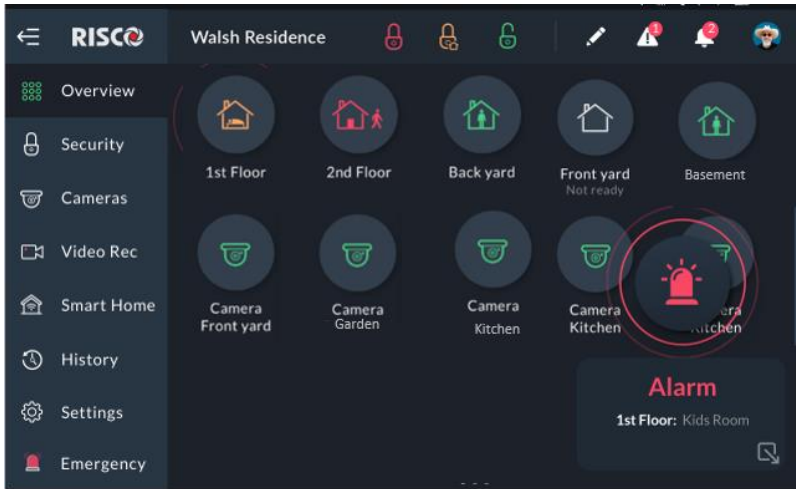




Figure 29: Incoming Alarm Floating Button

The name of the Zone/Partition that triggered the alarm is indicated under the floating button. However, if there is more than one source of alarm then “Multiple Alarms” are indicated. The user can always view the cause of the alarms in the Overview Screen or Security Screen.

- Click the  button at the bottom right corner of the screen to minimize the Floating Alarm button and allow the user to use the other buttons.
- Click the  button again to restore the Floating Alarm button to its original size.
- Click the Floating Alarm button to open the RisControl Security/Partitions Screen, where the user can view the full state of the alarm.

**Note:** When the Floating Alarm button appears on the screen, the user can click on any of the buttons in the Overview Screen except for the buttons that are physically covered by the floating alarm button.

# SECURITY

The security section of the RisControl describes all the operations and activities relevant to the Security System.

As in the Overview Screen, an initiated alarm will appear as a floating button at the bottom right of the Security Screen (except for the Security→Partitions screen).

## Partitions

The Security→Partitions screen is the default screen that is displayed after the user clicks the “Security” option in the main menu, as shown in the example below.

**Note:** If the Overview Screen is empty (the user did not add any shortcuts buttons to it), the Security→Partitions screen will be the default screen that is displayed upon each unlocking of the RisControl.

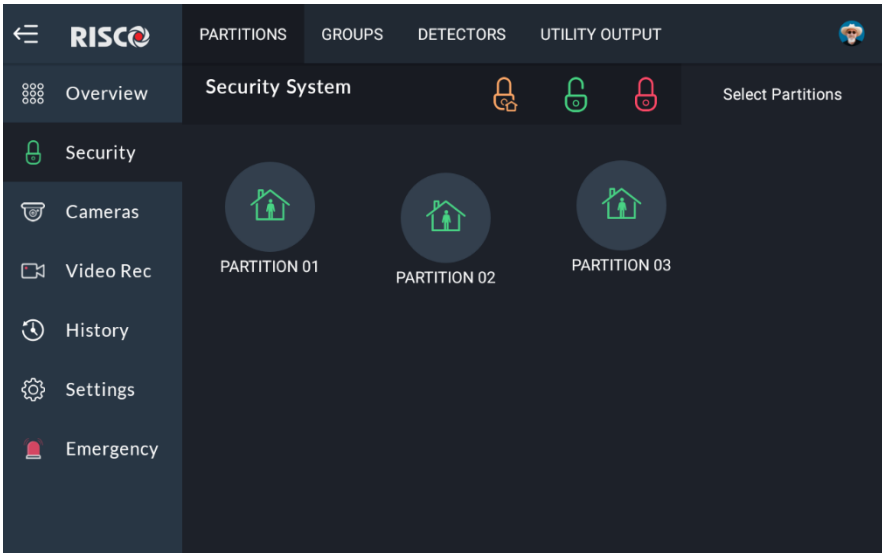
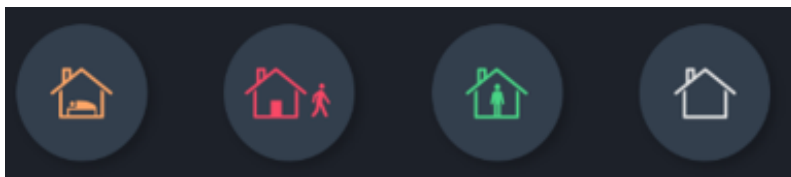


Figure 30: Security - Partition Screen

The Grand Master can view and make changes to the system’s partitions from the RisControl, independent of its masking. Other users, that have the required permissions to these partitions, can make changes only to the partitions within RisControl’s masked partitions.

The Partition state is indicated by the color, the image within the circle icon and the label below the state.



Stay=Orange    Armed=Red    Disarmed=Green    Not ready=Gray

## Arming and Disarming

The user can Full Arm, Stay Arm or Disarm any of the partitions on the screen. For example, if a user clicks a disarmed partition, a popup screen is displayed that allows the user to either Full Arm or Stay Arm the partition, as shown below.

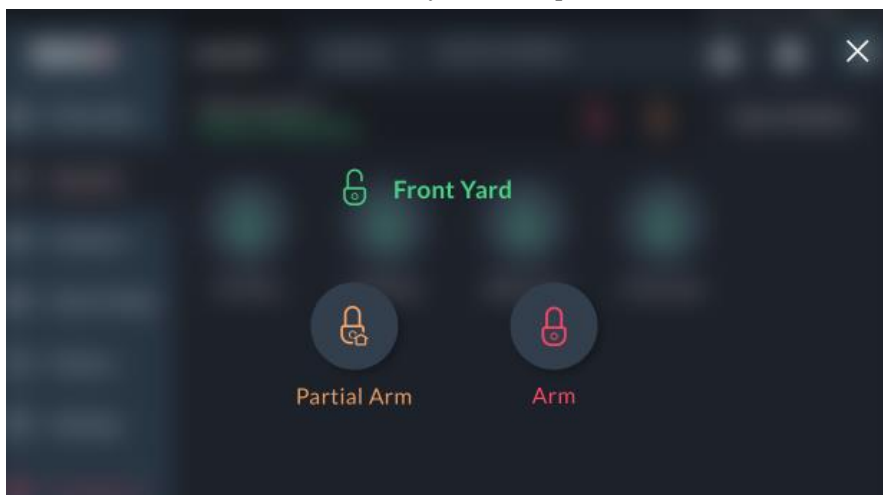


Figure 31: Arming a Partition Screen

**Note:** If a Partition fails to arm, this will be indicated as shown below.

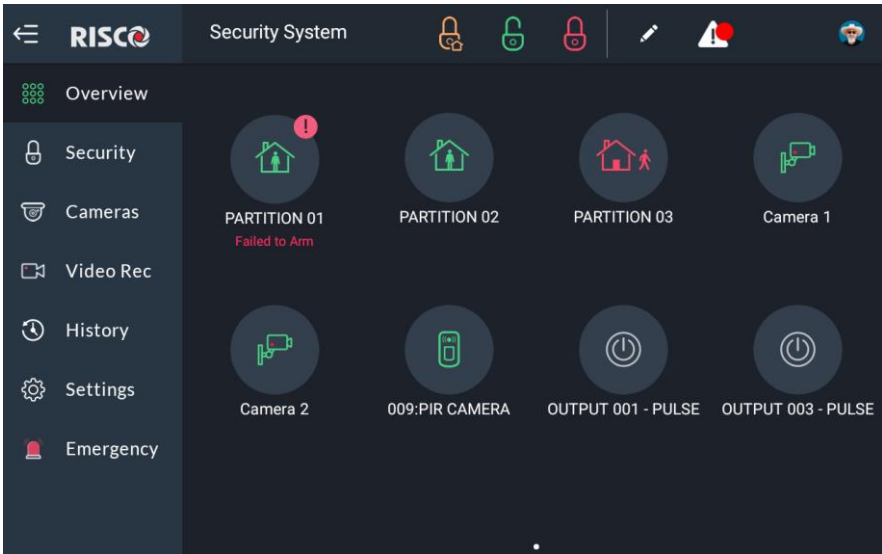
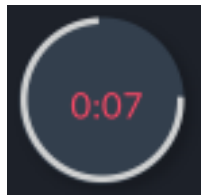


Figure 32: Partition Failed to Arm Screen

### Exit/Entry Delay

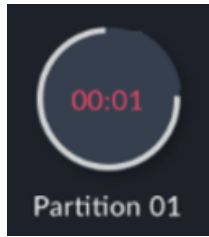
A partition that is defined with an Exit/Entry delay will be indicated on the screen via a contour-line button. The time remaining will be displayed at the center of the button. In addition, a beeping sound will be heard via the RisControl throughout the Exit/Entry time.



### Final Exit Zone

The Final Exit zone is the last detector to be activated on exit. When arming the system, the related partition arms 10 seconds after this zone is closed to indicate that the user has left the premises.

If the Final Exit zone was not closed after arming the system, the related partition will not be armed and one second time remaining will be displayed at the center of the button. In addition, a beeping sound will be heard via the RisControl throughout the Final Exit time. In this case, leave the premises through the Final Exit zone and close the door. The counter will restart, and the system will arm after 10 seconds have elapsed.

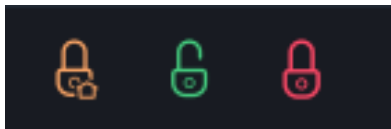


### One Click Activation of all Partitions

There are three lock icon buttons at the top of the screen, as follows:

- **Red Lock Icon button:** click to Full Arm all the partitions
- **Orange Lock Icon button:** click to Stay Arm all the partitions
- **Green Lock Icon button:** click to Disarm all the partitions

In addition, the user can simultaneously Full Arm, Stay Arm or Disarm all the partitions.



## Arming/Disarming Selected or All Partitions

1. Click the “Partitions” tab at the top of the screen; the following screen is displayed.

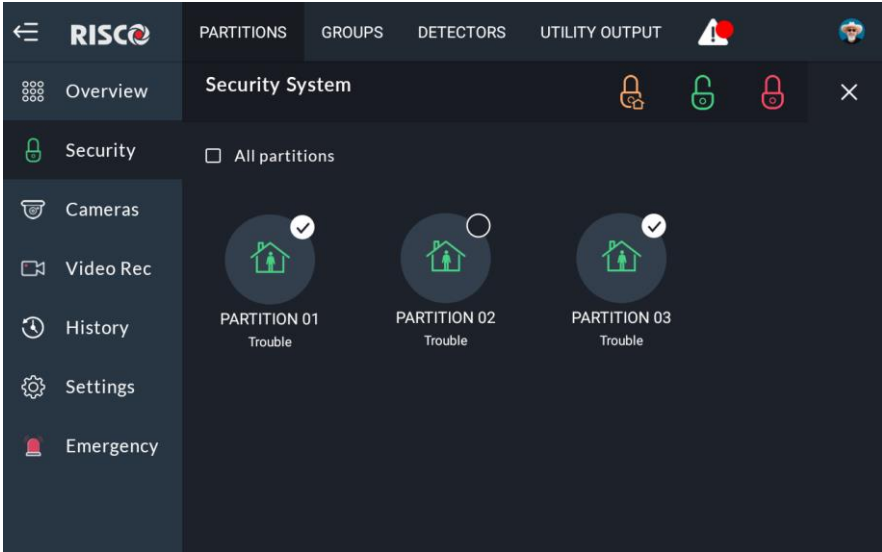


Figure 33: Selecting Multiple Partitions Screen

2. Click to select the partitions to be Armed or Disarmed; a “✓” is added to the partition icon  
– or –  
click the “All partitions” checkbox to select or unselect all the partitions.
3. Click the Full Arm/Stay Arm/Disarm Lock button, as required.

## Groups

After selecting the relevant partitions to which a zone will belong (performed in the previous section), you can now proceed to Groups. Groups are combined areas (zones) that can be armed within a specific partition and that are used for partial arming. There are up to 4 groups (A–D) maximum per partition. The user can arm any of the four groups individually.

The Security →Groups screen displays the groups the user is associated with.

**Note:** If the user is not associated to any group, the screen will be blank.

There are four Group icon status indications, as follows:

- **Green:** Disarmed
- **Orange:** Part Arm



- **Red:** Full Arm
- **Gray:** Not Ready

1. Click the Groups tab; the following screen is displayed.

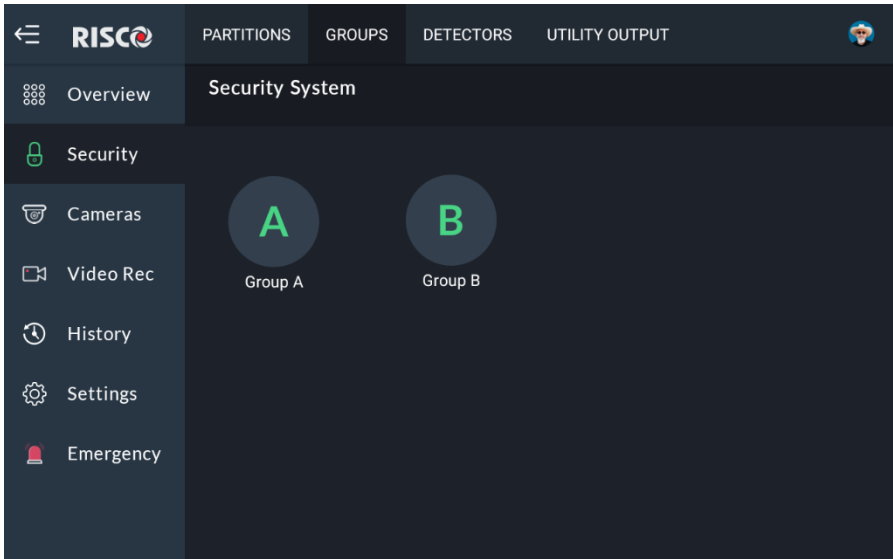


Figure 34: Selecting Groups Screen

2. Click the Group letter button corresponding to the Group/s you want to arm; the following screen displays the partitions in the available Groups to be armed.

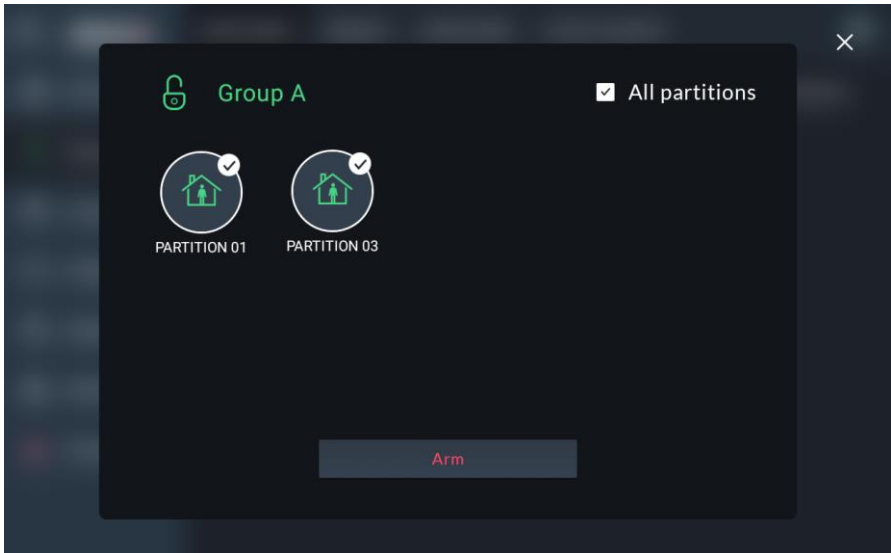


Figure 35: Selecting Groups Partitions Screen

3. Select the required Partitions and then click the “Arm” button.

**Note:** You can check/uncheck the ‘All Partitions’ box to select/deselect all Partitions by a single action.

The Group icon status indications (see above) also apply to the Groups Partitions screen.

**Note:** If after clicking the “Arm” button the selected Groups are not armed due to Not Ready state, a new screen will appear indicating the Groups that are Not Ready and the causes of the Not Ready states.

## Detectors

The Security→Detectors screen lists all the devices that are part of the partitions that the user has permission to view.

1. Click the Detectors tab; the following screen is displayed.

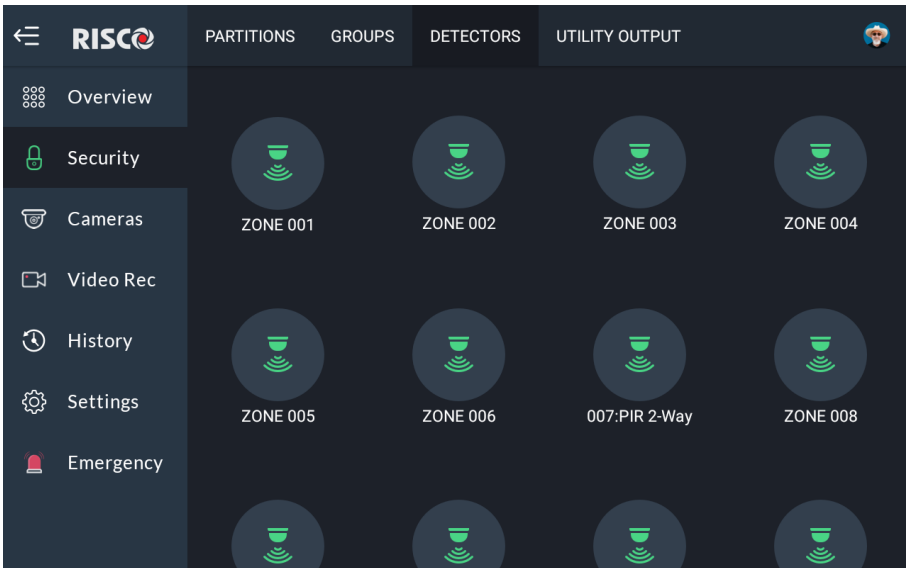


Figure 36: Security – Devices Screen

There are three detector icon status indications, as follows:

- **Green:** Disarmed
- **Orange:** Part Arm
- **Red:** Full Arm

2. Click any of the detectors to either bypass the detector or mute its “Presence Notification”, as shown below:

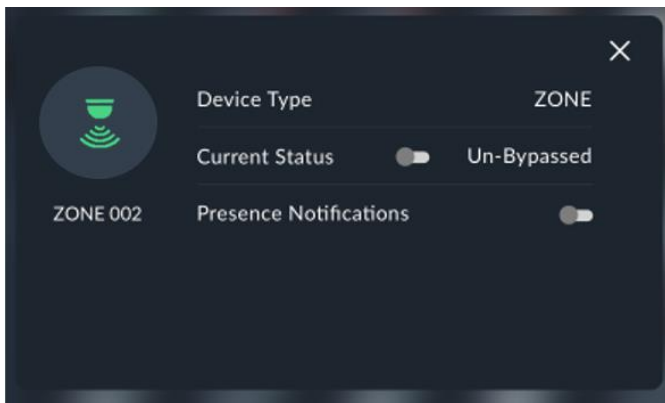


Figure 37: Detector Setup Screen

**Note:** For a detailed definition of the Bypass and the Presence Notifications, refer to the Security System's Installation Manual.

# Utility Outputs

On the Utility Outputs Screen, click the relevant Utility Output button to operate that output.



Figure 38: Utility Outputs Screen

# CAMERAS

The camera section lists all the cameras that are used in the system, including:

- Video cameras that are connected directly to the RISCO Cloud
- Video cameras that are connected to the RISCO Cloud through a RISCO Video Recorder
- PIRCAMs that are connected through the RISCO Security System

## Cameras Screen

Selecting the Cameras Menu displays the Cameras Screen, as shown in the example below. This screen is used for viewing the system cameras.

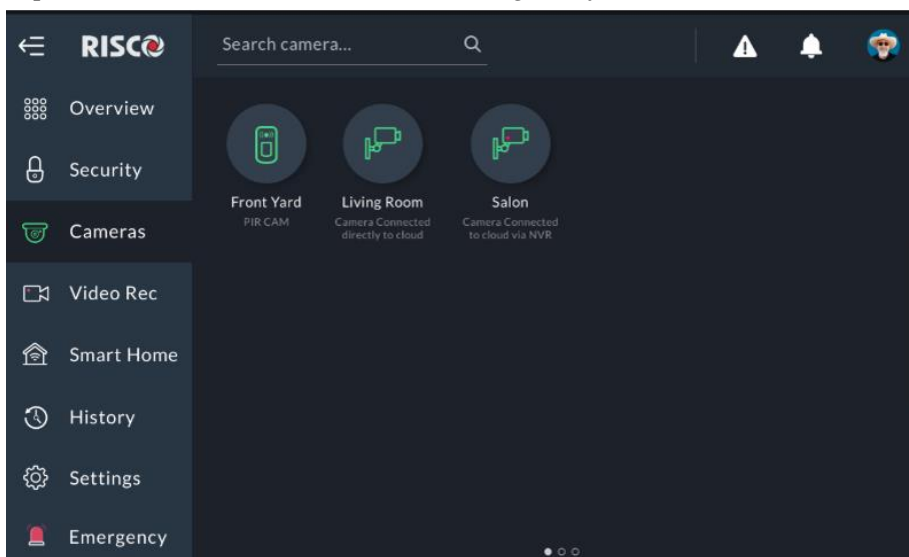
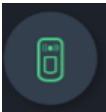
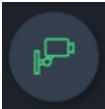
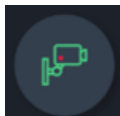


Figure 39: Cameras Screen

The Camera screen contains icons and names (in alphabetical order) of the cameras:

- PIR CAM 
- RISCO P2P Camera 



- Video Camera through a Video Recorder

**Note:** Connection through a Video Recorder is indicated by the dot inside the camera icon.

## PIR CAM

Click any of the PIR CAMs in the screen to view the images take by that camera.

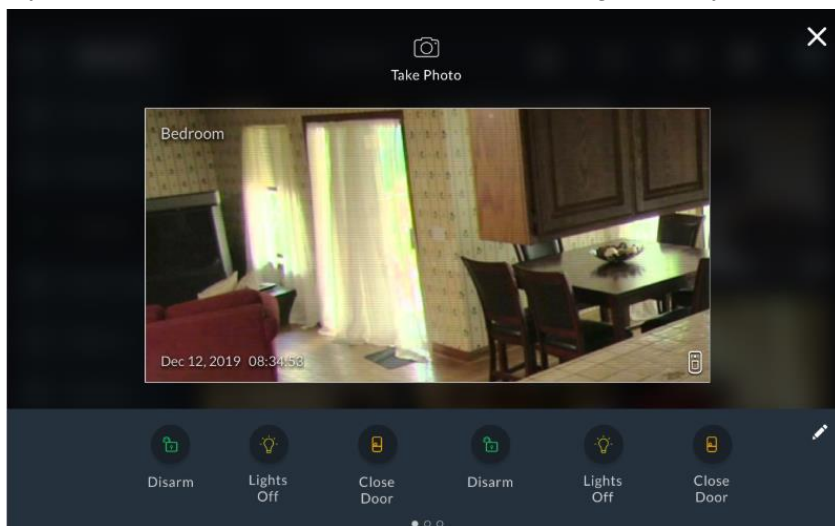



Figure 40: PIR Camera Image View

Click the “Take Photo”  button to command the camera to take a new photo. Use the Quick Buttons to perform selected activities (see Quick Buttons, page 49).

## Video Cameras

Click any of the P2P Cameras in the screen to view live video from that camera.

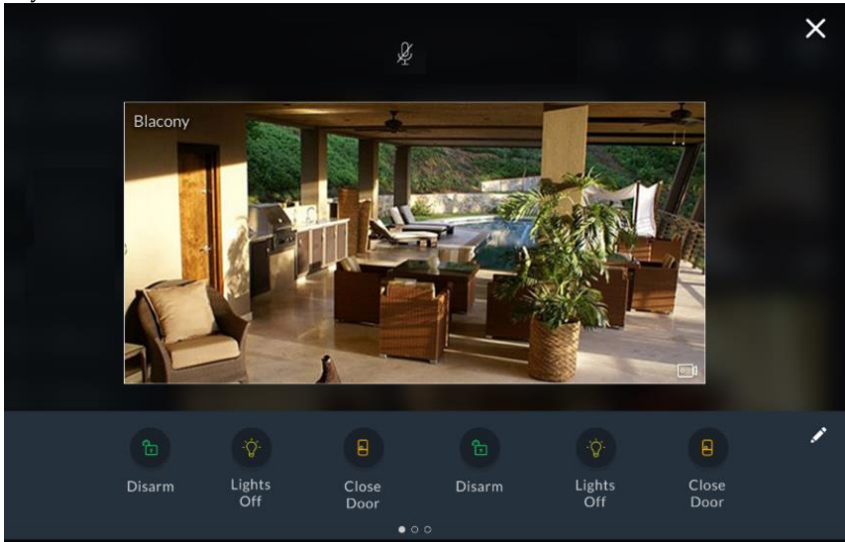



Figure 41: P2P Camera Live Video Screen

From the Live Video screen of the P2P camera, the user will be able to hear audio from the camera's microphone. However, the user's own voice will be muted and will not be heard via the camera. Click the  icon at the top of the screen to cancel the mute operation of the RisControl microphone.

Use the Quick Buttons to perform selected activities, (see Quick Buttons, page 49).

## The Cameras Screen

The Cameras Screen displays cameras that are connected directly to the RISCO Cloud and cameras that are connected to the RISCO Cloud through a RISCO Video Recorder.

**Note:** A camera that is connected via the RISCO Video Recorder is indicated by the dot inside the camera icon.

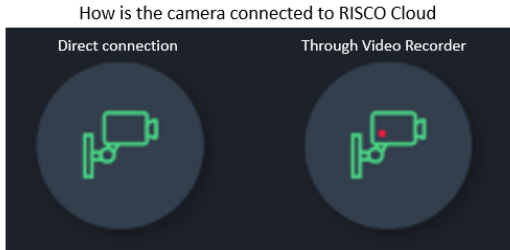


Figure 42: Cameras connected to the RISCO Cloud

By clicking on a camera icon of a RISCO Video Recorder, the live view of the camera is displayed. Cameras that are connected to the RISCO Video Recorder can also switch to show pre-recorded video clips (see Video Recorder, page 52).

An additional “Switch to Recording” button is displayed on the left side of the screen, as shown in the screen below.

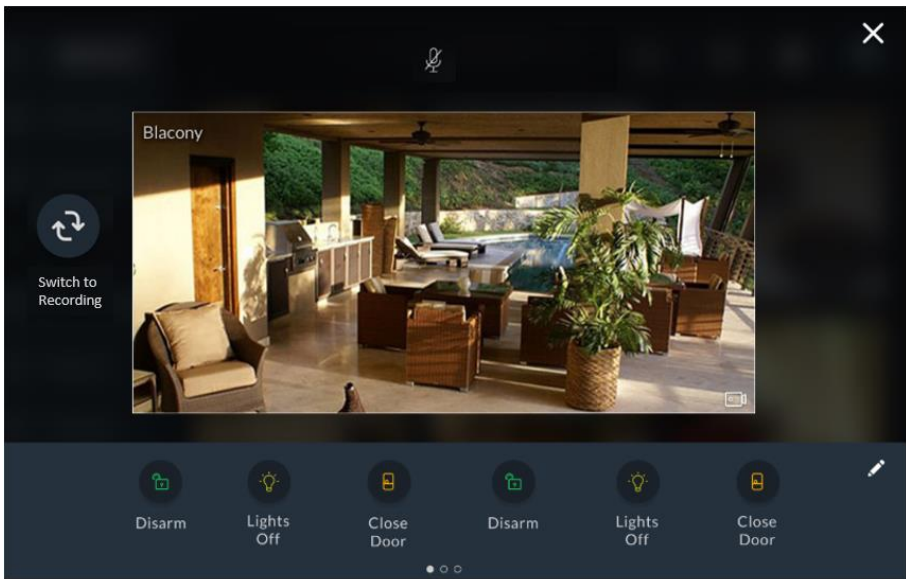


Figure 43: Camera through the RISCO Video Recorder Screen



# Quick Buttons

## Using Quick Buttons

The area at the bottom of the screen, that displays the images or video clips from the various camera types, is referred to as the “Quick Buttons Tray”.

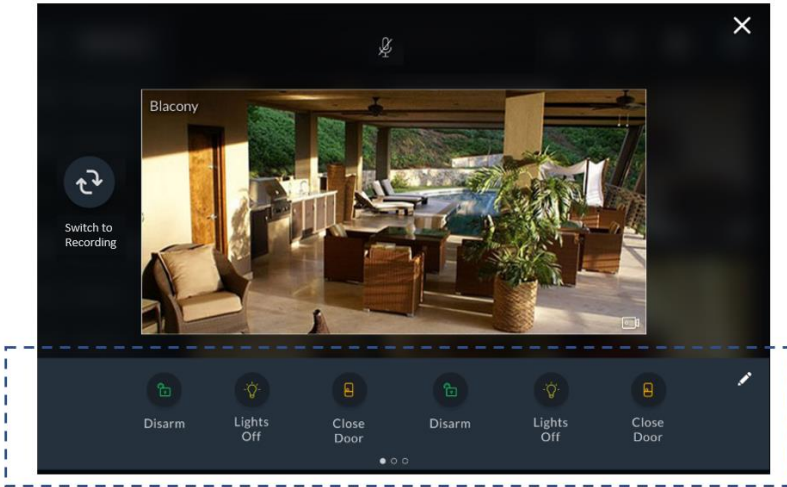


Figure 44: Quick Buttons Tray

## Quick Buttons Tray

The Quick Buttons Tray allows the user to perform activities while viewing the image and or video clip. For example, where a living room is monitored by a video camera and the lighting in the living room is controlled via one of the Utility Outputs (UO) of the Security System. In such a setting, the user can add the UO button to the Quick Buttons Tray and turn on/off the lights in the living room while watching it occur on the screen.

**Note:** A user can individually set the exact combination of Quick Buttons that will appear in the Quick Buttons Tray; separately for each camera and independent of the Quick Buttons’ selection of other users in the same RisControl.

## Editing the Quick Buttons Tray

Every user can individually select the Quick Buttons to be displayed in the Quick Buttons Tray of a camera that the user is watching.

To enter the edit mode of the Quick Buttons Tray, click the pencil icon  at the right corner of the tray.

## Adding/Removing Quick Buttons from the Tray

Upon entering the edit mode of the Quick Buttons Tray, all the Quick Buttons will appear with an “x” bubble on them.

To remove the Quick Button from the tray, click the “x” bubble of the Quick Button.

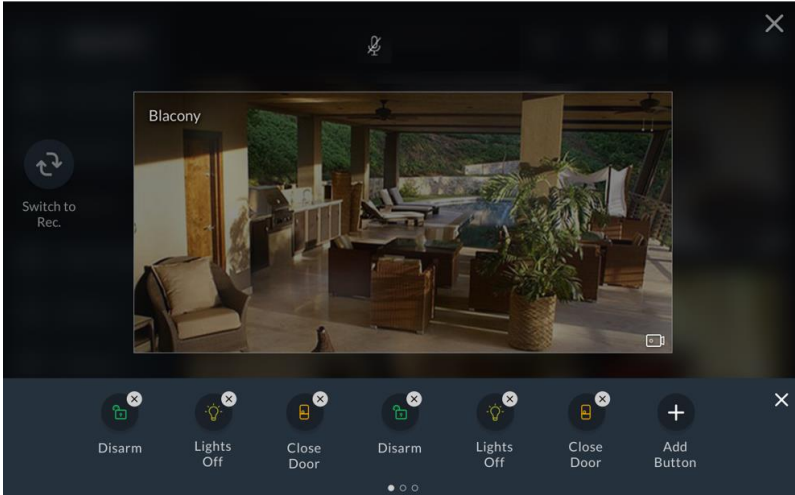


Figure 45: Adding / Removing Quick Buttons

## Adding/Removing Multiple Quick Buttons to/from the Quick Buttons Tray

1. Click the “+” icon above the tray; a new screen is displayed, listing all the available commands.
2. Check/uncheck the checkbox next to each command to add/remove the command to/from the Quick Buttons Tray.

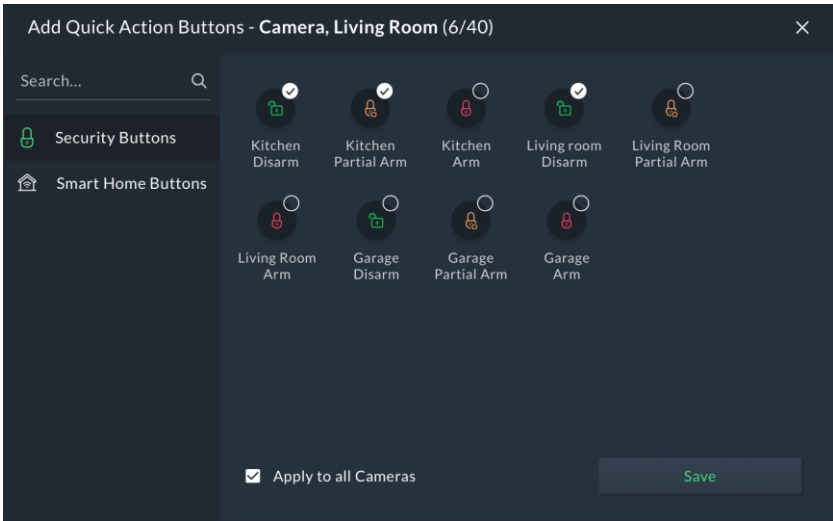


Figure 46: Editing the List of Quick Buttons

3. Select the "Apply to all" box to set the current selection of Quick Buttons to all the cameras for which the user has permissions.

## VIDEO RECORDER

When a Video Recorder is installed in a site (a physical location in the RISCO Cloud where equipment is installed), a user, with the required permission, can watch live videos and playback video clips from cameras that are connected via the Video Recorder.

**Note:** The user must be logged into the RISCO Cloud via the RisControl to be able to watch playback on the Video Recorder.

If you click “Video Rec” in the main menu without logging into the RISCO Cloud via the RisControl, the following screen is displayed:

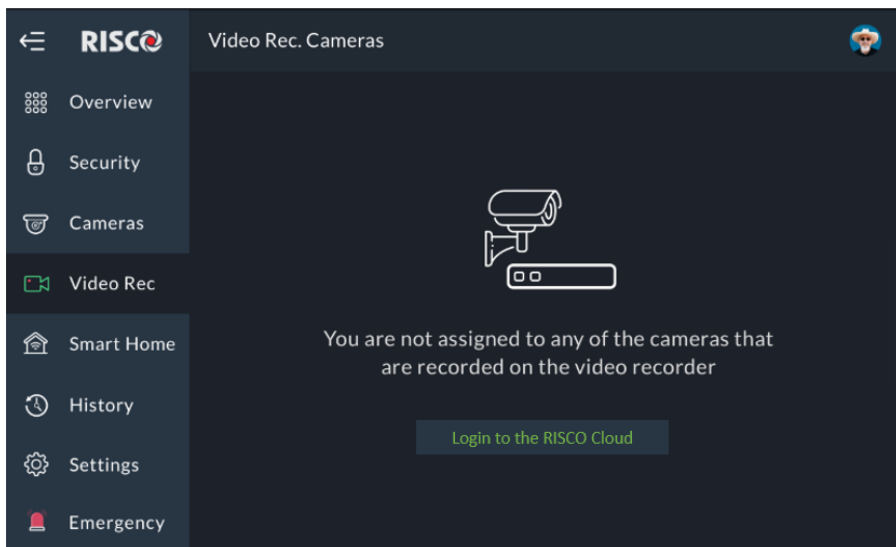


Figure 47: User is not Logged into the RISCO Cloud

Click the “Login to the RISCO Cloud” button and continue to the login procedure, as described in “Users & Permissions Settings” (see page 64).

## Video Recorder Live Gallery

After you have logged into the RISCO Cloud, click “Video Rec” from the menu. The Live Gallery screen or the Video Recorder is displayed.

**Note:** The Live Gallery Screen can be set up in one of three layout formats: 2x2, 3x3 and 4x4 images.

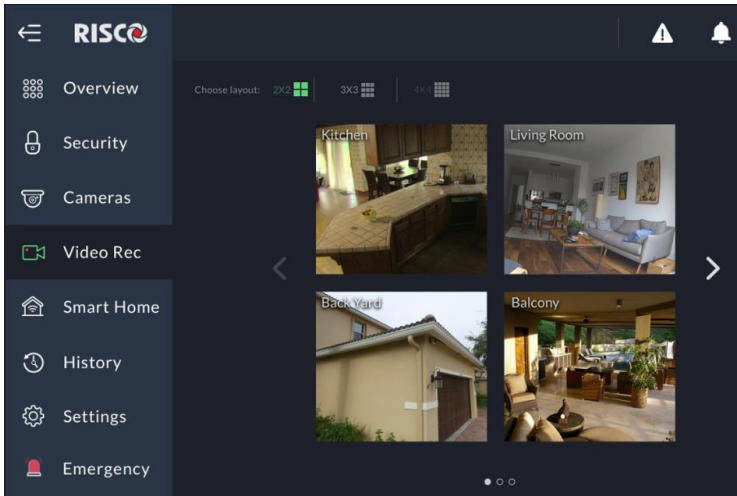



Figure 48: Video Rec Live Gallery Screen - 2x2 image layout

To change the Live Gallery Image Layout, click the buttons located above the images: . The selected layout will be remembered by the RisControl separately for each user.

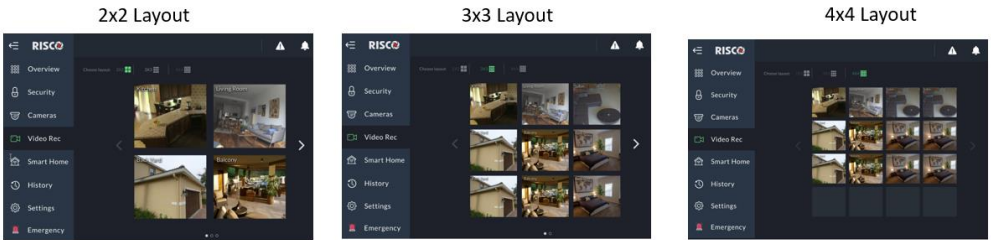


Figure 49: Video Rec – Live Gallery Image Layouts

The Gallery displays a matrix of live videos taken from cameras, with the camera name indicated on each video (empty areas are darkened).

## Camera Video Playback

To watch recorded video clips from any given camera, click the camera image in the Gallery, as shown in the example below.

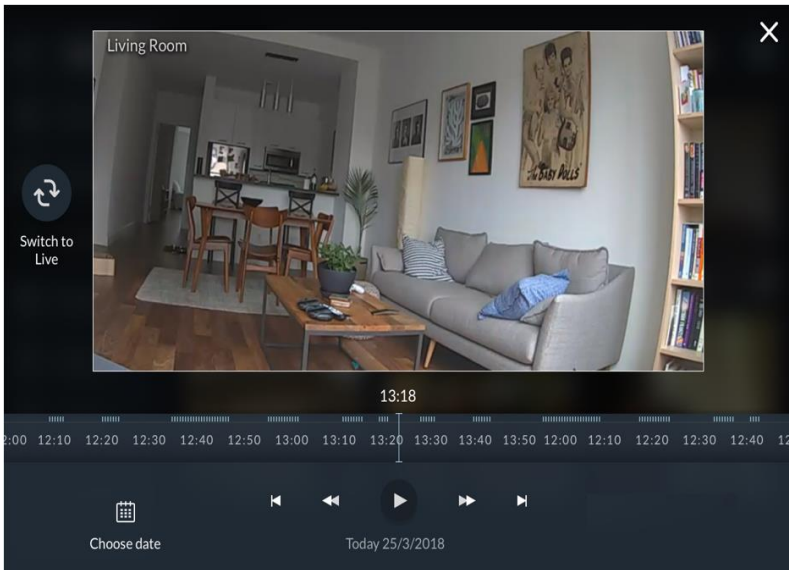


Figure 50: Playback Screen

## Time Slider

The Time Slider that appears under an image, provides the exact time each video clip was recorded.

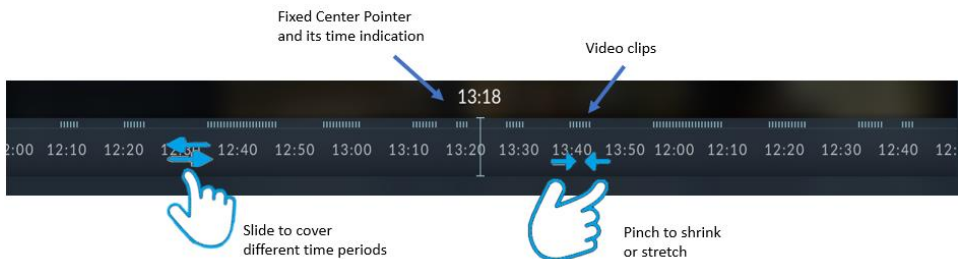


Figure 51: Time Slider Screen

**Time Slider coverage range** - The slider is set to cover 24 hours, from 00:00:00 to 23:59:59 of the current date, by default. You can extend or shrink the slider by pinching it outward, or by using two fingers to cover any time frame between 10 minutes to 24 hours.

**Time Slider Center Pointer** – the pointer at the center of the Time Slider is fixed, showing the exact time that it points to at each moment. Use your finger to slide the Time Slider left of right, until the Center Pointer points to the exact required time.




**Video clip indications on the slider** – Recorded video clips are indicated on the Time Slider using blue ticks. See the following example of 3 clips that were recorded: .

## Playback Controls

There are four standard playback control buttons, as follows:



Figure 52: Playback Control Buttons

- |  |                              |  |
|--|------------------------------|--|
|   | <b>Play</b>                  | Click to play the “next clip”, i.e. the clip that is situated on, or to the right of, the Center Pointer |
|  | <b>Fast Forward/Backward</b> | Click to double the forward or backward speed of the playback  |
|  | <b>Next/previous</b>         | Click to jump to the next/previous video clip  |

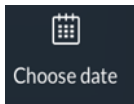
## Date Selection

The date indication at the bottom of the screen refers, always, to the date of the Center Pointer.

Slide the Time Slider backward and forward to change the date indication to always show the date that is relevant to the Center Pointer.

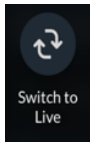
You can also view recordings of any other date by manual date selection.

Click the “Chose date” button at the bottom of the screen and select the required date from the calendar.



## Switch back to Live

Click the “Switch to Live” button at any time to switch the view from Playback to Live camera mode.



## **SMART HOME**

RisControl will support the RISCO Smart Home in a future RisControl version.



# HISTORY

Selecting the History Menu displays the History Screen, as shown in the example below. This screen is used for the viewing a history log of events. For each event you can view the date and time that the event occurred, a description of the event and the detector or device that caused the event.

RisControl can store up to 2000 events. These events are logged in chronological order according to date and time. When the event log exceeds the maximum of 2,000 events, the oldest events are overwritten by the newest events.

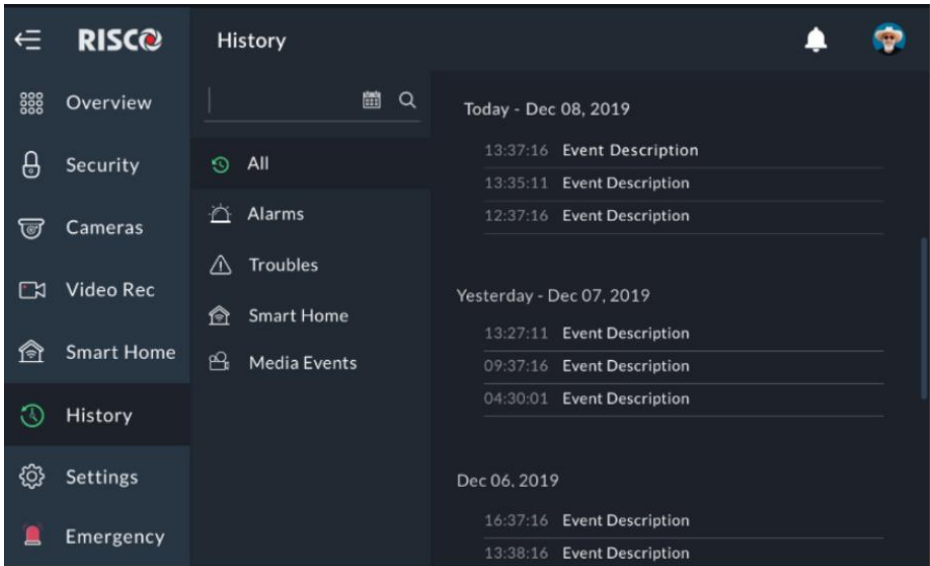


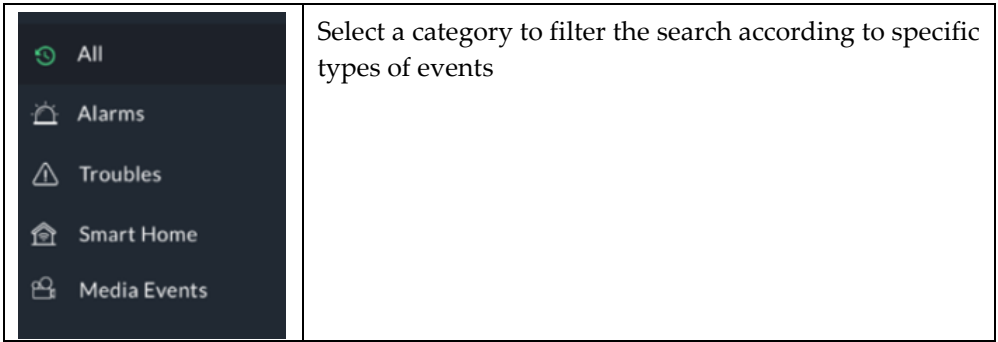


Figure 53: Event History Menu Screen

## Searching Events

Select the relevant event history view filtering tab. The Event History Screen can be filtered by Alarms, Troubles, Smart Home, Media Events or All. You can also use the following event search options:

Option	Description
	Search for specific events (the results of the search appear on the right-hand side of the screen)
	Search for events according to specific dates



## Media Events

You can view captured snapshot images or video clips recorded during specific related alarm events.

Click the “Media Events” option, search for the event and then click on the event to view.

# SETTINGS

The Settings Menu displays the System Settings Screen, as shown in the example below. This screen is used for defining RisControl parameters and defining date and time settings.

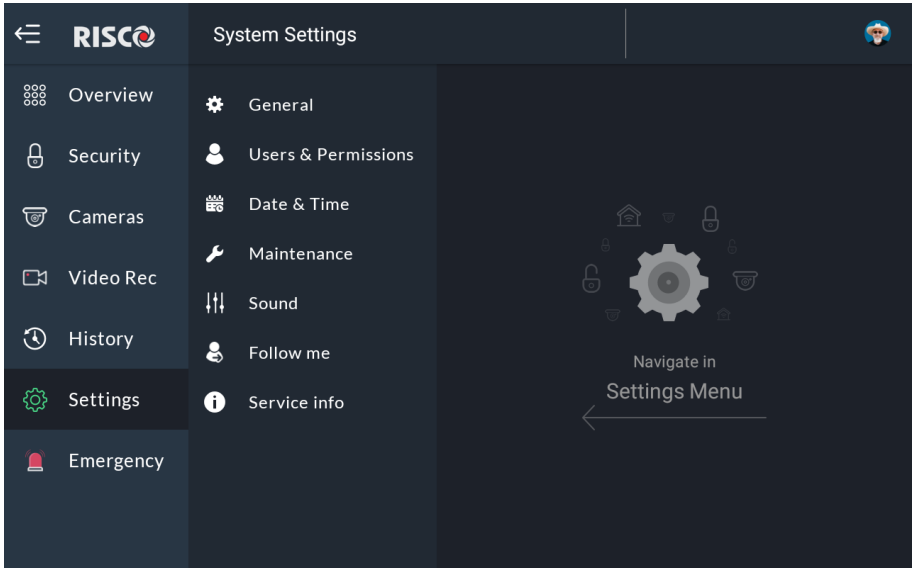


Figure 54: Settings Menu Screen

**Note:** All the Menu options are available only to the Grand Master of the system. Only the “Users & Permissions” screen is available to other users, for them to set their own user details.

# General

Click the “General” Sub-Menu; the following screen is displayed:

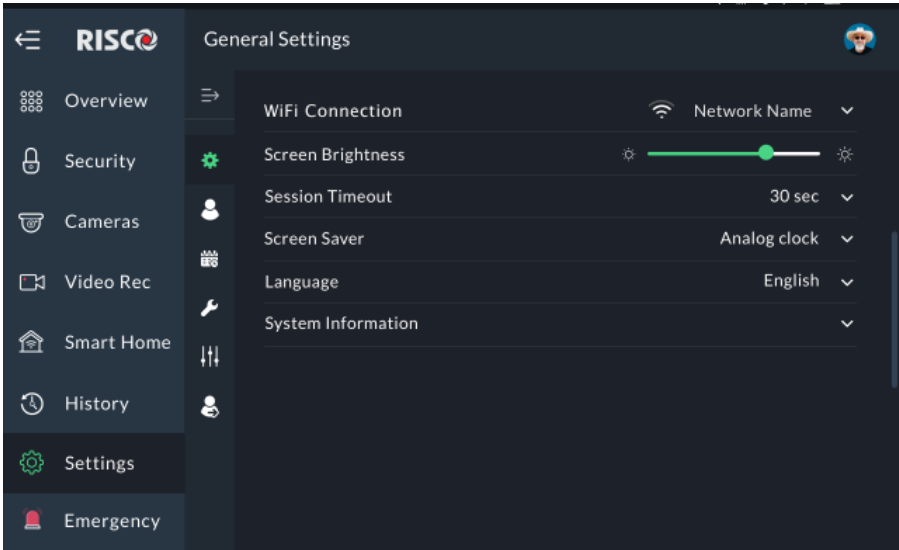


Figure 55: Settings Menu - General

## Wi-Fi Connection

Click the Wi-Fi connection option to connect the RisControl to a Wi-Fi router that is connected to the Internet.

The RisControl will search for available networks and allow the user to select one of them.

**Note:** RisControl can be used without connection to the RISCO Cloud. In this case, most operations that are applicable to the Security System will be available, except for Cameras, Video Recorders and other cloud related features that are not supported.

## Screen Brightness

Click and drag the slider to adjust the brightness of the RisControl screen.



Figure 56: Screen Brightness

## Session Timeout

The RisControl will automatically lock following a predefined “idle” time (Session Timeout) during which the screen has not been touched. The Grand Master can select between 15, 30- or 40-seconds session timeout.

1. Click the Session Timeout option in the menu.
2. Select the preferred duration.

**Note:** The Grand Master can also manually lock a session by clicking on the user’s avatar at the top right corner of the screen and then clicking “Lock screen”, as described in RisControl Top Bar, page 16.

## Screen Saver

The Grand Master of the system can set the appearance of the Screen Saver.

1. Click the “Screen Saver” option; the following screen is displayed.

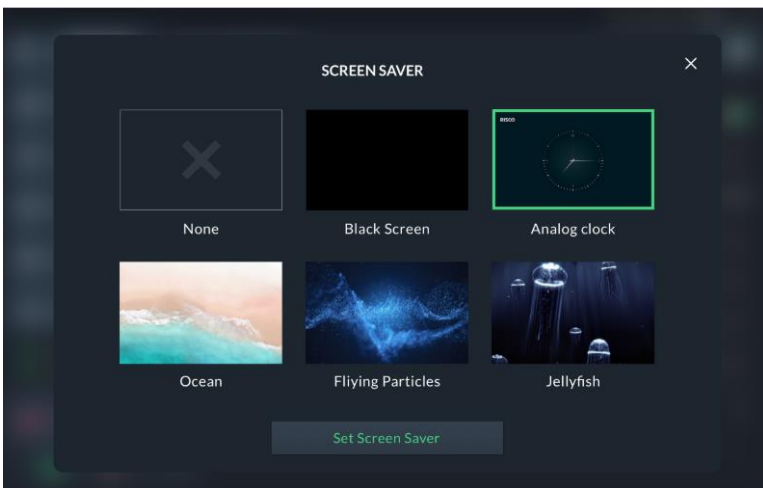


Figure 57: Screen Saver Selection

2. Select one of the options, and then click the “Set Screen Saver” button; the selected Screen Saver will appear for as long as RisControl is in the Screen Saver state.

Screen Saver Options:

- **None** – RisControl does not enter Screen Save mode.
- **Black Screen** – during Screen Saver mode the screen is black.
- **Analog Clock** – a real-time clock is displayed.
- **Ocean, Flying Particles and Jellyfish** – short video clips that repeat continuously.

## Language

The Grand Master can change the language of the RisControl.

Click the “Language” option and select the desired language from the list.

The language selection is applicable only to the RisControl that is being set up and is not applicable to the other RisControl units, or to the language of the Security System.

## System Information

The Grand Master can view system information and set additional system parameters.

Click the “System Information” option; the following screen is displayed.



Figure 58: System Information Screen

## Manual (Software) Update

Manual (software) update is performed by the Grand Master and is applicable only to a RisControl that is connected to the Internet through the Wi-Fi network.

1. Click the “Check for Update” button; if an update is available, the following RISCO Cloud screen is displayed.

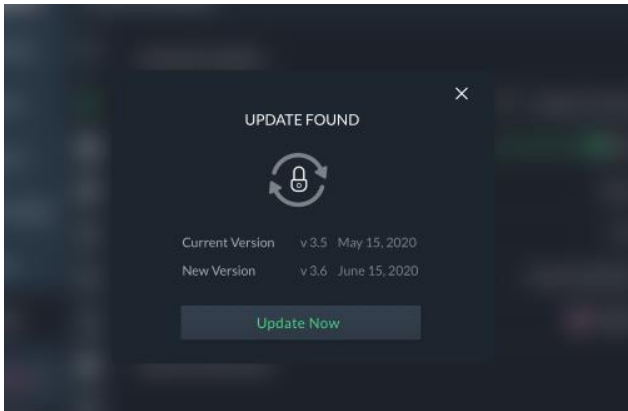


Figure 59: Software Update Screen

2. Click the “Update Now” button; a download of the updated software version is initiated.


**Note** The downloaded version is not installed automatically but must be initiated by the Grand Master.

If a search for updates by the Grand Master shows an update to be downloaded, the following Software Update menu option is displayed.



Figure 60: Software Update Menu Option Screen

3. Click the “Download” button.

**Note:** When there is a new software version that the RisControl knows about (after performing “Check for Update”), a new software version notification will be added to the Notification List  (see Notifications Management, page 21).

After the new software version is downloaded but is not yet installed, the RisControl will prompt the user to install it. If the user selects to install the downloaded version, RisControl will perform the procedure and then self-restart with the new running version.

## RisControl Software Version

Displays the current Software Version of the RisControl.

## RisControl IP Address & MAC

Displays the IP Address and MAC of the RisControl

## Security System SW Version

Displays the SW Version of the Security System.

## Security System IP Address

Displays the IP Address of the Security System.

## RisControl Bus ID

The RisControl BUS ID displays the Bus Address (Virtual DIP Switch) of the panel.

## Users and Permission Settings

The Grand Master and Master Users can add users to the Security System from the RisControl.

**NOTE:** The "Add User" procedure in the RisControl refers to adding Panel Users and not Cloud Users which is a separate procedure performed using the RISCO Web User Application.

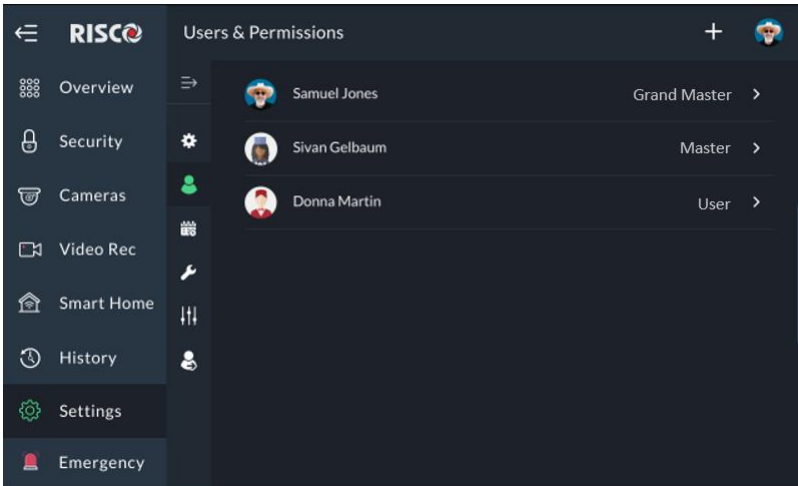


Figure 61: Users List Screen



## Add a User

You can add a New User to the system.

1. From the Settings Menu, click “Users & Permissions”.

A list is displayed of the Grand Master or Master User and all the users under this level. The Grand Master or Master User can edit any existing user. Other users can only view their own name that is listed with restrictions to the type of editing that can be performed.

2. Click the “+” button at the top bar; the following screen is displayed.

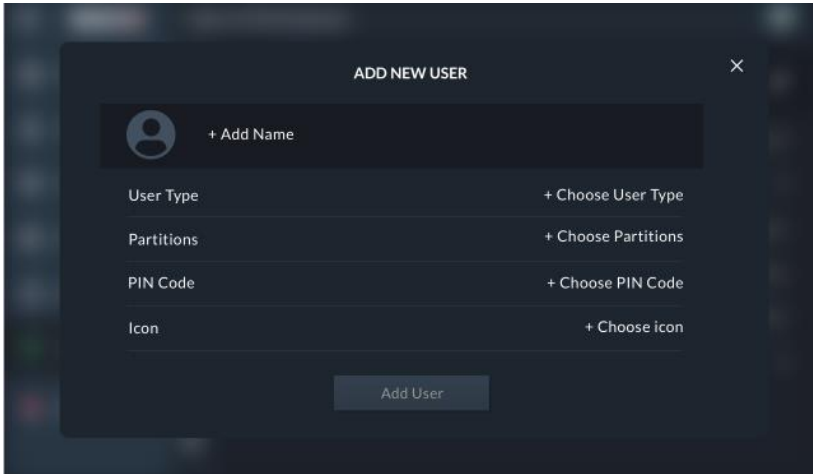


Figure 62: Add a User Screen

User Settings	Description
<b>Add Name</b>	Enter a name for the user
<b>User Type</b>	Select the User Type from the list
<b>Partitions</b>	Select one or more partition(s) that the user will have permission
<b>PIN Code</b>	Enter a PIN code for the New User - one that is not assigned to another user in the system
<b>Icon</b>	Select an avatar that will represent the user

**NOTE:** The “Add User” button will be enabled after all the fields are entered.

3. Click the “Add User” button to complete the procedure; a success message will be displayed confirming that the new user is now valid and operational.

**NOTE:** If the entered PIN Code is rejected by the panel, an operation failed message will be displayed.

## Edit or Delete a User

The Grand Master or Master User can edit or delete any of the users that are in their list.

### ➤ To edit a user:

1. Click “Users & Permissions” and select a user that you want to edit.
2. Perform the required changes and click the “Save” button.

### ➤ To delete a user:

1. Click “Users & Permissions” and select a user that you want to delete.
2. Click the “Delete User” button.

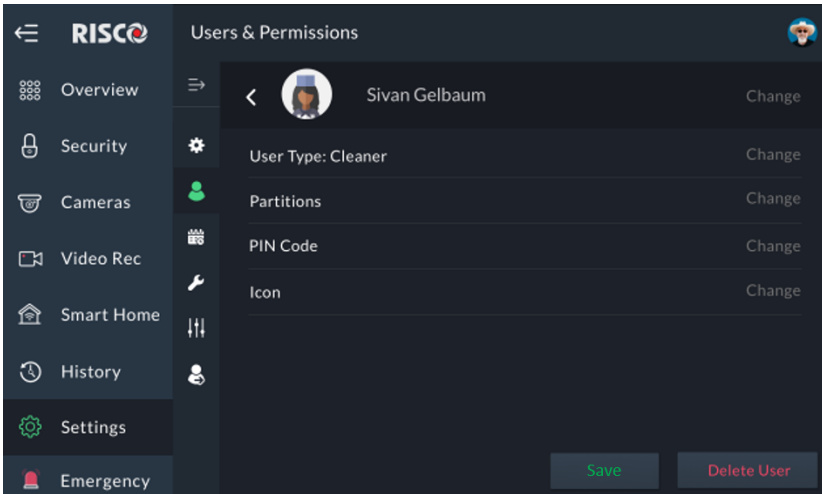


Figure 63: Edit or Delete a User Screen

## Edit a User’s Own Details

Users can edit their own details.

1. From the Settings menu, click “Users & Permissions”.
2. Click on your own username; the following screen is displayed.

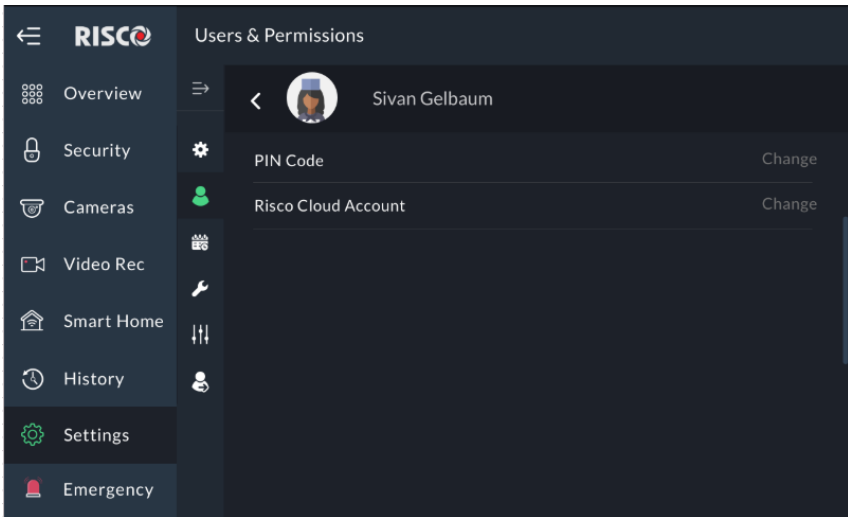


Figure 64: Edit User's Own Details Screen

The user can modify the details on the screen, such as their name, PIN Code. and RISCO Cloud Account.

### **Login to the RISCO Cloud**

The screen below is used to login to the RISCO Cloud.

1. Enter your RISCO Cloud username and password.
2. Click the "Login" button.

#### **Notes:**

1. The username and password will be remembered for future login attempts, without the need to reenter credentials.
2. Upon each entry of the PIN Code in the RisControl, the user will also be automatically logged into the RISCO Cloud.
3. The login procedure applies only to the RisControl in which the first login was performed. If the same user wants to use another RisControl that is connected to the same Security System, the user must again perform initial login to the RISCO Cloud for the other RisControl.

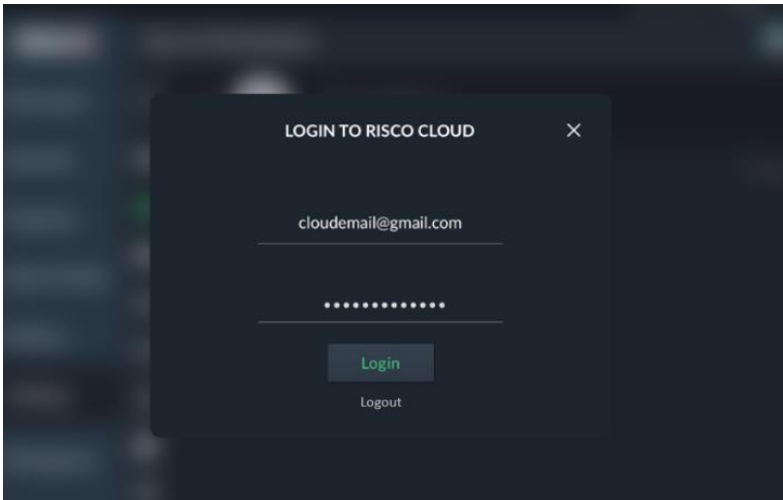


Figure 65: Login to the RISCO Cloud Screen

## Date & Time

Selecting the Settings menu displays the Date & Time Screen, as shown in the screen below. This screen is used for defining date and time settings for the RisControl.

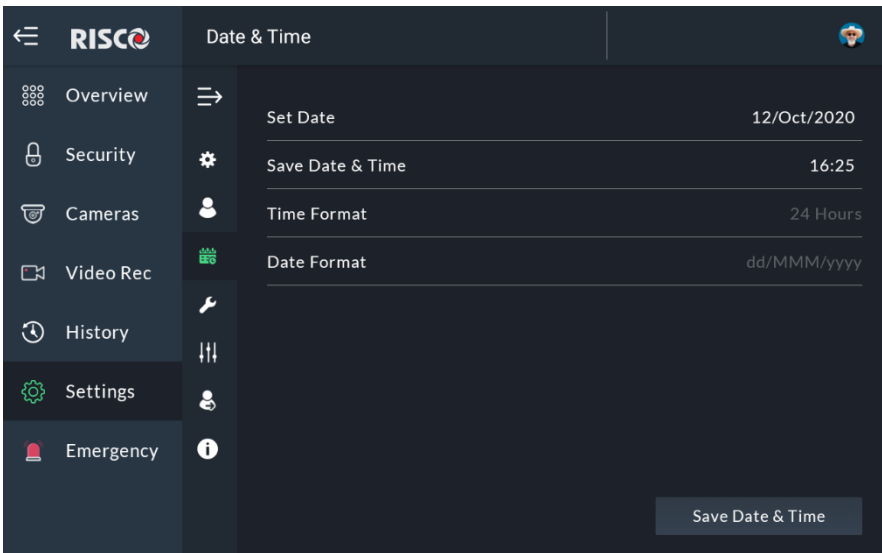


Figure 66: Date & Time Screen

## Date & Time Settings

When the “Sync Date & Time with Panel” toggle button is turned on, the RisControl obtains the date and time information from the panel. In this case, all settings options on this screen are disabled.

When the “Sync Date & Time with Panel” toggle button is turned off, the RisControl manages its own date and time. In this case, the user can define the date and time settings and format.

## Maintenance

### The Maintenance Menu

Enter the Settings Menu and select “Maintenance”.

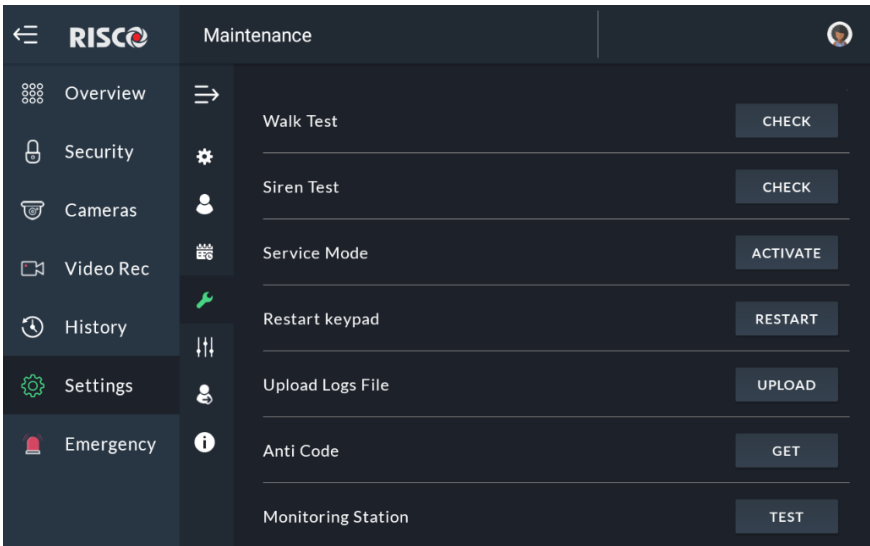


Figure 67: Maintenance Screen

The Grand Master can perform the following maintenance activities:

- Walk Test
- Siren Test
- Service Mode
- Restart Keypad
- Upload Logs File
- Anti Code
- Monitoring Station

## Walk Test

1. In the “Walk Test” option, click the “CHECK” button; the Walk Test begins.
2. Trip the zones to be tested; the results will be displayed on the screen, as in the example below.

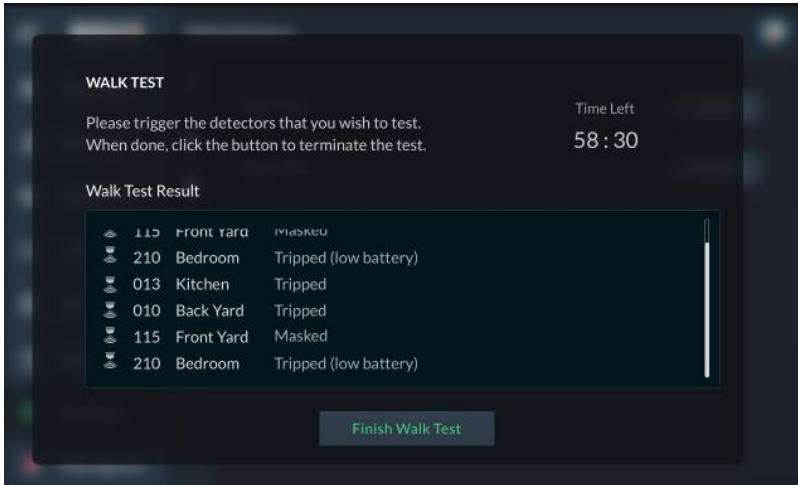


Figure 68: Walk Test Result Screen

The duration for the “Walk Test” is 60 minutes max. A down counter indicates the remaining time for the test.

3. Walk through and trip the zones that are being tested.

The tripped zones that are identified by the Security System will be listed in the RisControl screen. These zones indicate that the zones are responsive and are, therefore, detectable.

4. When done, click the “Finish Walk Test” button.

**Note:** If the “Finish Walk Test” button is not clicked, the Walk Test will terminate automatically at the end of the 60-minute period.

## Siren Test

1. Click the “CHECK” button to enter the “Siren Test”.

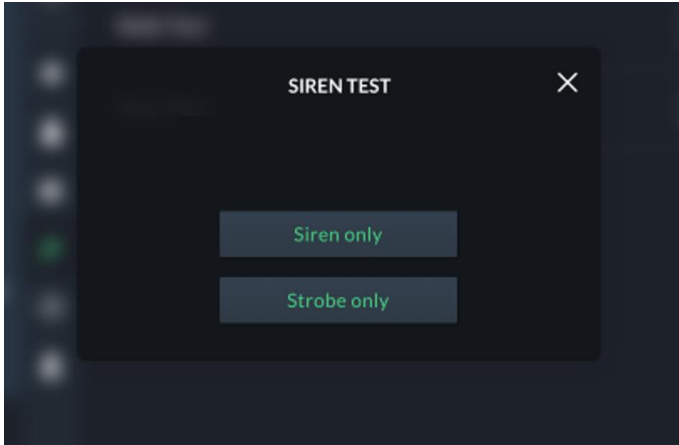


Figure 69: Siren Test Screen

2. Click the “Siren Test” or the “Strobe Test” button to perform the test.

## Service Mode

Activating “Service” mode silences all tamper alarms from detectors and accessories for an installer-defined period of time. During this time, you can replace wireless detector and accessory batteries without tamper alarms sounding.

1. Click the “ACTIVATE” button to activate “Service Mode”.
2. Replace the device batteries, as required.

## Restart Keypad

Click the “RESTART” button to restart the RisControl Keypad.

## Upload Logs File

You can upload log files to a predefined storage location, where access to these files will be given to RISCO support.

1. Click the “Upload Logs File” button; the file name will be displayed on the next screen that opens.

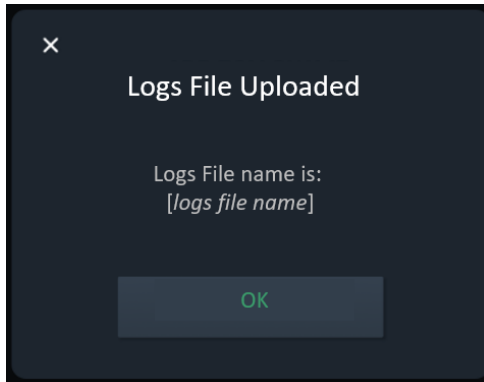


Figure 70: Logs File Uploaded Confirmation Screen

2. Click "OK".

### Anti-Code

Some of the End-User's activities cannot be performed without permission from the installer. The "Anti Code" feature allows the installer to approve specific activities to the end-user without having to physically visit the site. When this permission is required, the end-user initiates a phone call with the installer after which the installer will instruct the user to enter the SETTINGS/MAINTENANCE screen in the RisControl, and enter the Anti Code, as described below.

**Note:** The Anti Code feature must be enabled by the installer in the panel.

1. Click the "Get" button for the "Anti-Code, the following screen is displayed.

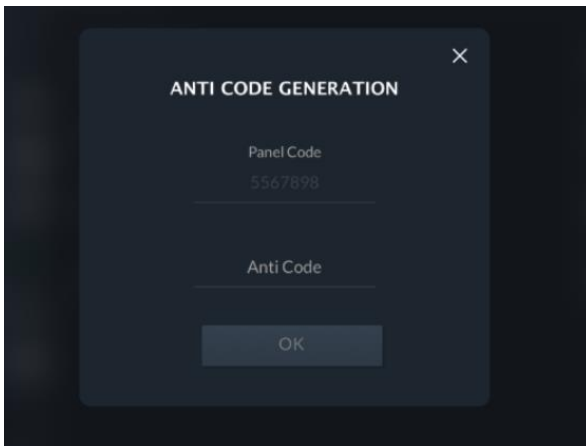


Figure 71: Entering an Anti-Code Screen

The "Panel Code" is generated automatically by the Security System

2. Contact the installer and inform him of the Panel Code.



The Installer uses the Panel Code to generate the “Anti-Code”.

3. Contact the installer and inform him of the Anti-Code.
4. Enter the code in the “Anti-Code” field and then click the “OK” button to complete the procedure.

## Monitoring Station

Click the “TEST” button to send a test message to the monitoring station, according to requirements for EN50131 standards.

## Sounds

The user can change the sound settings of the RisControl.

The user can also individually turn on/off the following sounds:

- Buzzer
  - Key tones
  - Chime
1. Click “Sounds” in the Settings Menu; the following screen is displayed.

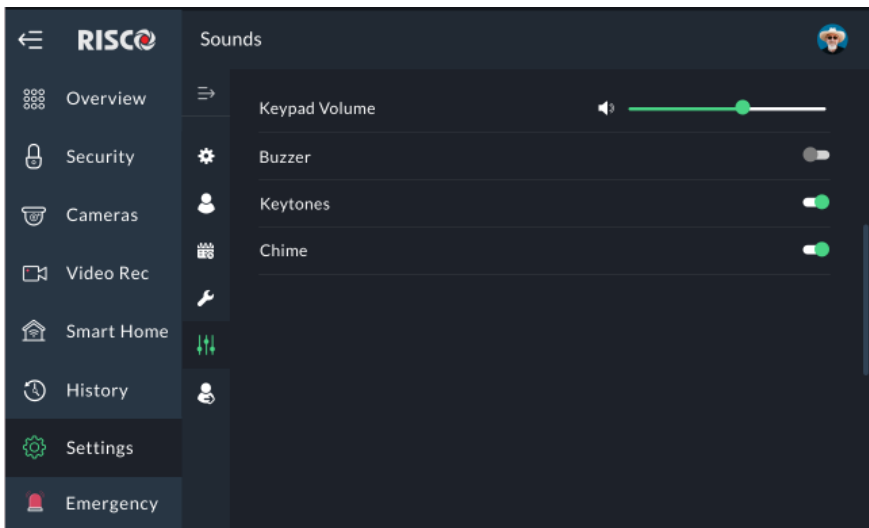


Figure 72: Sound Settings Screen

2. Drag to set the volume of the RisControl speaker (also increases/decreases all the sounds that are generated by the RisControl).

# Follow Me

The user can add Follow Me recipients, up to the limit defined in the panel.

## Adding a Follow Me Recipient

1. Enter the “Follow Me” option of the Maintenance and click the “+” button at the top bar.

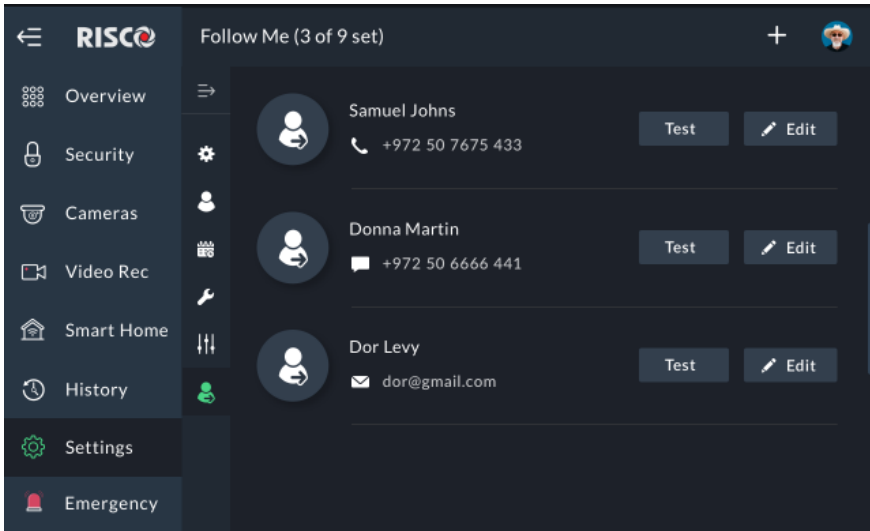


Figure 73: Follow Me Screen

The following screen is displayed.

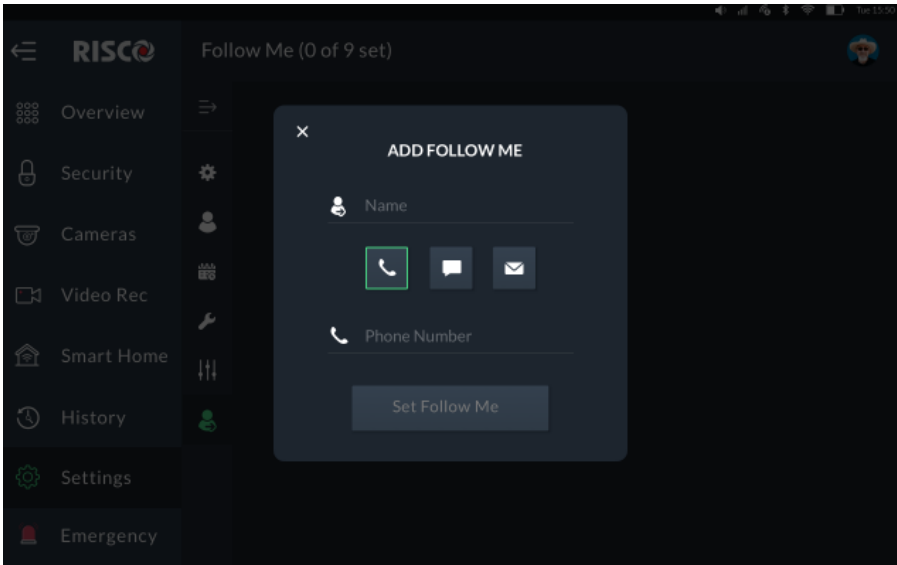


Figure 74: Add Follow Me Screen

2. Click to select the type of communication channel you wish to use for this particular Follow Me:
3. Enter the information in the corresponding fields:

Name	Enter the name of the recipient
Phone or SMS	Enter a Phone number
Email	Enter the email address

4. Click the “Set Follow Me” button to complete the procedure.

### Test or Edit a Follow Me

To edit or send a test message, click the “Test” or “Edit” button in the Follow Me List.

### Service Info

Click Service info to view the contact details of the installation company defined in the control panel or iRISCO app (if the RisControl is connected to the RISCO Cloud).

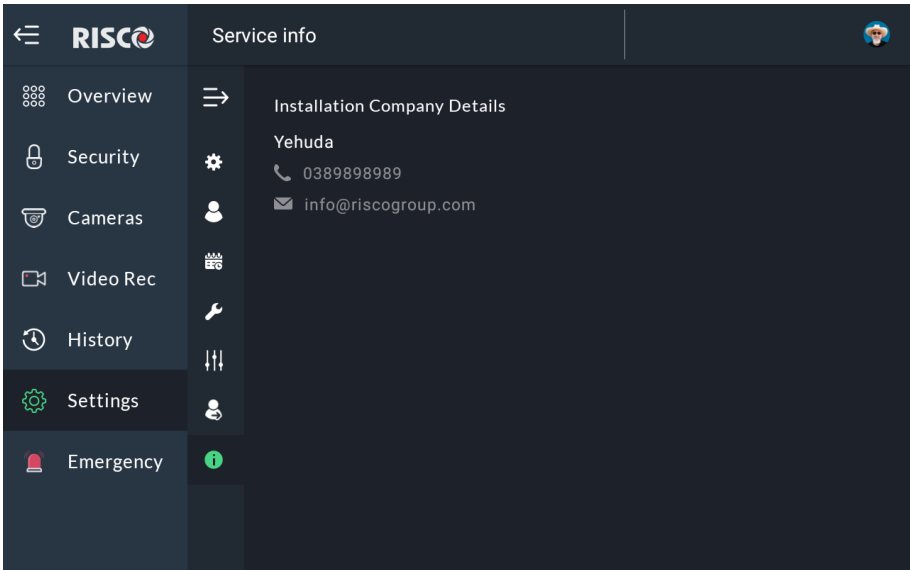


Figure 75: Service Info Screen

# EMERGENCY

The Emergency button appears at the top of the Lock Screen, at the end of the Main Menu.

**Note:** The Emergency button will appear on the screen only if Emergency Keys was enabled by the installer in the panel.

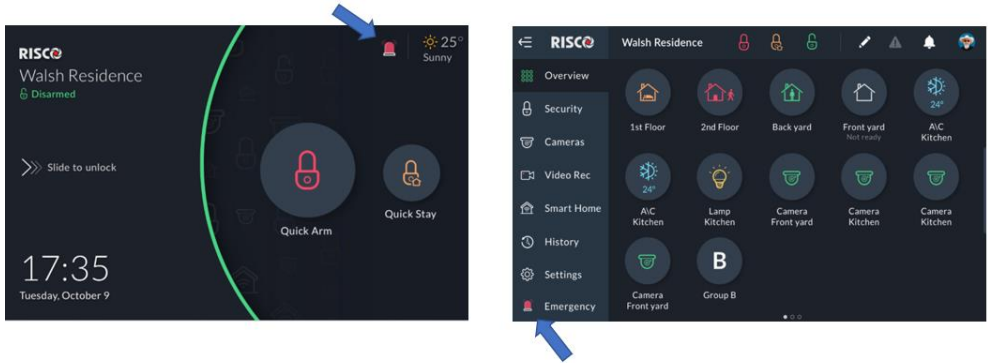


Figure 76: Emergency Button Screen

## Emergency Button Position in Lock Screen/Main Menu

Click the Emergency button ; the following screen is displayed.

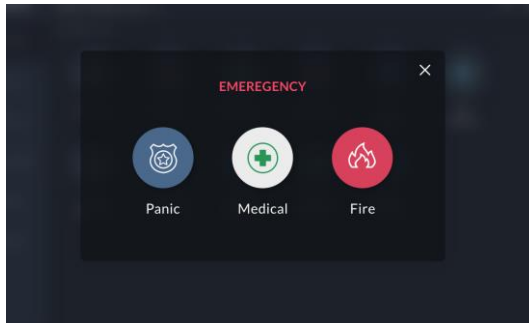


Figure 77: Emergency Type Selection Screen

## Emergency Type Selection

To activate Panic/Medical/Fire alert, click the corresponding two buttons simultaneously for at least 2 seconds.

## SPECIFICATIONS

<b>Operating Voltage</b>	13.8V ±10%
<b>Power consumption</b>	170 mA, 5W max.
<b>Display</b>	8-inch IPS, Resolution 800x1280, Illumination 300 cd/m <sup>2</sup>
<b>Type of touch screen</b>	Capacitive touch, 5-point touch control supported
<b>System</b>	Android 7.1.2
<b>CPU</b>	A83T Octa-core Cortex A7
<b>Memory</b>	1G DDR3M RAM, 8G EMMC Flash
<b>Wi-Fi</b>	802.11 b/g/n 2.4 GHz
<b>Bluetooth</b>	BT 4.0, 2.4 GHz
<b>Output Power</b>	20 dBm Max.
<b>Operating Temperature</b>	-10°C to 55°C (14°F to 131°F)
<b>Speaker</b>	1 speaker, 8 Ohm / 1W
<b>Microphone</b>	1xmic
<b>Connections</b>	USB – 1xtype C USB Jack RS-485 – detachable terminal block
<b>Tamper</b>	1xTamper
<b>Standard</b>	EN50131-3, Grade 3 Environmental Class II, PD 6662:2017
<b>P/N</b>	RP432KPT000A

### RED Compliance Statement:

Hereby, RISCO Group declares that this equipment complies with the essential requirements and other relevant provisions of Directive 2014/53/EU. For the CE Declaration of Conformity please refer to our website: [www.riscogroup.com](http://www.riscogroup.com).



## **FCC ID:JE4RP432KPT**

This device complies with part 15 of the FCC Rules. Operation is subject to the following two conditions:

- (1) This device may not cause harmful interference, and
- (2) This device must accept any interference received, including interference that may cause undesired operation

Changes or modifications to this equipment which are not expressly approved by the party responsible for compliance (RISCO Group's.) could void the user's authority to operate the equipment.

## **FCC Note**

This equipment has been tested and found to comply with the limits for a Class B digital device, pursuant to part 15 of the FCC Rules.

These limits are designed to provide reasonable protection against harmful interference in a residential installation. This equipment generates uses and can radiate radio frequency energy and, if not installed and used in accordance with the instructions, may cause harmful interference to radio communications. However, there is no guarantee that interference will not occur in a particular installation. If this equipment does cause harmful interference to radio or television reception, which can be determined by turning the equipment on and off, the user is encouraged to try to correct the interference by one or more of the following measures:

- ✦ Reorient or relocate the receiving antenna.
- ✦ Increase the separation between the equipment and the receiver.
- ✦ Connect the equipment into an outlet on to a different circuit from that to which the receiver is connected.
- ✦ Consult the dealer or an experienced radio/TV technician for help.

RF Exposure Statement: For the product, under normal use condition is at least 20cm away from the body of the user,the user must keeping at least 20 cm distance to the product.

For the FCC Supplier's Declaration of Conformity please refer to our webwbsite:  
[www.riscogroup.com](http://www.riscogroup.com)

# Standard Limited Product Warranty

RISCO Ltd., its subsidiaries and affiliates (“**Risco**”) guarantee Risco’s hardware products to be free from defects in materials and workmanship when used and stored under normal conditions and in accordance with the instructions for use supplied by Risco, for a period of (i) 24 months from the date of connection to the Risco Cloud (for cloud connected products) or (ii) 24 months from production (for other products which are non-cloud connected), as the case may be (each, the “**Product Warranty Period**” respectively).

**Contact with customers only.** This Product Warranty is solely for the benefit of the customer who purchased the product directly from Risco, or from any authorized distributor of Risco. Nothing in this Warranty obligates Risco to accept product returns directly from end users that purchased the products for their own use from Risco’s customer or from any installer of Risco, or otherwise provide warranty or other services to any such end user. Risco customer shall handle all interactions with its end users in connection with the Warranty, inter alia regarding the Warranty. Risco’s customer shall make no warranties, representations, guarantees or statements to its customers or other third parties that suggest that Risco has any warranty or service obligation to, or any contractual privity with, any recipient of a product.

**Return Material Authorization.** In the event that a material defect in a product shall be discovered and reported during the Product Warranty Period, Risco shall, at its option, and at customer's expense, either: (i) accept return of the defective Product and repair or have repaired the defective Product, or (ii) accept return of the defective Product and provide a replacement product to the customer. The customer must obtain a Return Material Authorization (“**RMA**”) number from Risco prior to returning any Product to Risco. The returned product must be accompanied with a detailed description of the defect discovered (“**Defect Description**”) and must otherwise follow Risco’s then-current RMA procedure in connection with any such return. If Risco determines in its reasonable discretion that any Product returned by customer conforms to the applicable warranty (“**Non-Defective Products**”), Risco will notify the customer of such determination and will return the applicable Product to customer at customer’s expense. In addition, Risco may propose and assess customer a charge for testing and examination of Non-Defective Products.

**Entire Liability.** The repair or replacement of products in accordance with this warranty shall be Risco’s entire liability and customer’s sole and exclusive remedy in case a material defect in a product shall be discovered and reported as required herein. Risco’s obligation and the Warranty are contingent upon the full payment by customer for such Product and upon a proven weekly testing and examination of the product functionality.

**Limitations.** The Product Warranty is the only warranty made by Risco with respect to the Products. The warranty is not transferable to any third party. To the maximum extent permitted by applicable law, the Product Warranty does not apply and will be void if: (i) the conditions set forth above are not met (including, but not limited to, full payment by customer for the product and a proven weekly testing and examination of the product functionality); (ii) if the Products or any part or component thereof: (a) have been subjected to improper operation or installation; (b) have been subject to neglect, abuse, willful damage, abnormal working conditions, failure to follow Risco’s instructions (whether oral or in writing); (c) have been misused, altered, modified or repaired without Risco’s written approval or combined with, or installed on products, or equipment of the customer or of any third party; (d) have been damaged by any factor beyond Risco’s reasonable control such as, but not limited to, power failure, electric power surges, or unsuitable third party components and the interaction of software therewith or (e) any delay or other failure in performance of the product attributable to any means of communications, provided by any third party service provider (including, but not limited to) GSM interruptions, lack of or internet outage and/or telephony failure.



BATTERIES ARE EXPLICITLY EXCLUDED FROM THE WARRANTY AND RISCO SHALL NOT BE HELD RESPONSIBLE OR LIABLE IN RELATION THERETO, AND THE ONLY WARRANTY APPLICABLE THERETO, IF ANY, IS THE BATTERY MANUFACTURER'S WARRANTY.

Risco makes no other warranty, expressed or implied, and makes no warranty of merchantability or of fitness for any particular purpose. For the sake of good order and avoidance of any doubt:

**DISCLAIMER.** EXCEPT FOR THE WARRANTIES SET FORTH HEREIN, RISCO AND ITS LICENSORS HEREBY DISCLAIM ALL EXPRESS, IMPLIED OR STATUTORY, REPRESENTATIONS, WARRANTIES, GUARANTEES, AND CONDITIONS WITH REGARD TO THE PRODUCTS, INCLUDING BUT NOT LIMITED TO ANY REPRESENTATIONS, WARRANTIES, GUARANTEES, AND CONDITIONS OF MERCHANTABILITY, FITNESS FOR A PARTICULAR PURPOSE, TITLE AND LOSS OF DATA. WITHOUT LIMITING THE GENERALITY OF THE FOREGOING, RISCO AND ITS LICENSORS DO NOT REPRESENT OR WARRANT THAT: (i) THE OPERATION OR USE OF THE PRODUCT WILL BE TIMELY, SECURE, UNINTERRUPTED OR ERROR-FREE; (ii) THAT ANY FILES, CONTENT OR INFORMATION OF ANY KIND THAT MAY BE ACCESSED THROUGH THE PRODUCT BY CUSTOMER OR END USER SHALL REMAIN SECURED OR NON DAMAGED. CUSTOMER ACKNOWLEDGES THAT NEITHER RISCO NOR ITS LICENSORS CONTROL THE TRANSFER OF DATA OVER COMMUNICATIONS FACILITIES, INCLUDING THE INTERNET, GSM OR OTHER MEANS OF COMMUNICATIONS AND THAT RISCO'S PRODUCTS, MAY BE SUBJECT TO LIMITATIONS, DELAYS, AND OTHER PROBLEMS INHERENT IN THE USE OF SUCH MEANS OF COMMUNICATIONS. RISCO IS NOT RESPONSIBLE FOR ANY DELAYS, DELIVERY FAILURES, OR OTHER DAMAGE RESULTING FROM SUCH PROBLEMS.

RISCO WARRANTS THAT ITS PRODUCTS DO NOT, TO THE BEST OF ITS KNOWLEDGE, INFRINGE UPON ANY PATENT, COPYRIGHT, TRADEMARK, TRADE SECRET OR OTHER INTELLECTUAL PROPERTY RIGHT

IN ANY EVENT RISCO SHALL NOT BE LIABLE FOR ANY AMOUNTS REPRESENTING LOST REVENUES OR PROFITS, PUNITIVE DAMAGES, OR FOR ANY OTHER INDIRECT, SPECIAL, INCIDENTAL, OR CONSEQUENTIAL DAMAGES, EVEN IF THEY WERE FORESEEABLE OR RISCO HAS BEEN INFORMED OF THEIR POTENTIAL.

Risco does not install or integrate the product in the end user security system and is therefore not responsible for and cannot guarantee the performance of the end user security system which uses the product.

Risco does not guarantee that the product will prevent any personal injury or property loss by burglary, robbery, fire or otherwise; or that the product will in all cases provide adequate warning or protection. Customer understands that a correctly installed and maintained alarm may only reduce the risk of burglary, robbery or fire without warning, but is not an assurance or a guarantee that such an event will not occur or that there will be no personal injury or property loss as a result thereof. Consequently Risco shall have no liability for any personal injury, property damage or loss based on a claim that the product fails to give warning.

No employee or representative of Risco is authorized to change this warranty in any way or grant any other warranty.

## Important Notice

This document is delivered subject to the following conditions and restrictions:

This document contains proprietary information belonging to RISCO Group. Such information is supplied solely for the purpose of assisting explicitly and properly authorized users of the system. No part of its contents may be used for any other purpose, disclosed to any person or firm, or reproduced by any means, electronic or mechanical, without the express prior written permission of RISCO Group. The information contained herein is for the purpose of illustration and reference only.

Information in this document is subject to change without notice. Corporate and individual names and data used in examples herein belong to their respective owners.

# Contacting RISCO Group

RISCO Group is committed to customer service and product support. You can contact us through our website [www.riscogroup.com](http://www.riscogroup.com) or via the following RISCO branches:

**Belgium (Benelux)**

Tel: +32-2522-7622  
support-be@riscogroup.com

**China (Shanghai)**

Tel: +86-21-52-39-0066  
support-cn@riscogroup.com

**France**

Tel: +33-164-73-28-50  
support-fr@riscogroup.com

**Israel**

Tel: +972-3-963-7777  
support@riscogroup.com

**Italy**

Tel: +39-02-66590054  
support-it@riscogroup.com

**Spain**

Tel: +34-91-490-2133  
support-es@riscogroup.com

**United Kingdom**

Tel: +44-(0)-161-655-5500  
support-uk@riscogroup.com

**USA**

Tel: +1-631-719-4400  
support-usa@riscogroup.com

This RISCO product was purchased at:



© RISCO Group 2022. All rights reserved. No part of this document may be reproduced in any form without prior written permission from the publisher.