



**HEAT RECOVERY VENTILATORS &
ENERGY RECOVERY VENTILATORS**

METRO

HRVs:

**METRO 120D
METRO 120F
METRO 120D-ECM
METRO 120F-ECM**

ERVs:

**METRO 120 ERV
METRO 120ERV
METRO 120 ERV-ECM
METRO 120 ERVD-ECM**

Homeowner's Manual

General Information

Heat Recovery Ventilators (HRV) Energy Recovery Ventilators (ERV) are designed to supply fresh air to a building while exhausting an equal amount of stale air from the building. An energy savings is experienced during the process by reducing the heating (or cooling) requirements.

HRV/ERV Overview:

- (1) Core
- (2) Filters
- (3) Collars
- (4) Electrical Box
- (5) Terminal Block
- (6) Motorized Impellers

Airflow:

- ⇨ Stale Air to Outside
- ⇨ Fresh Air from Outside
- ⇨ Stale Air from Inside
- ⇨ Fresh Air to Inside

Note: Illustration purposes only, your unit may look different

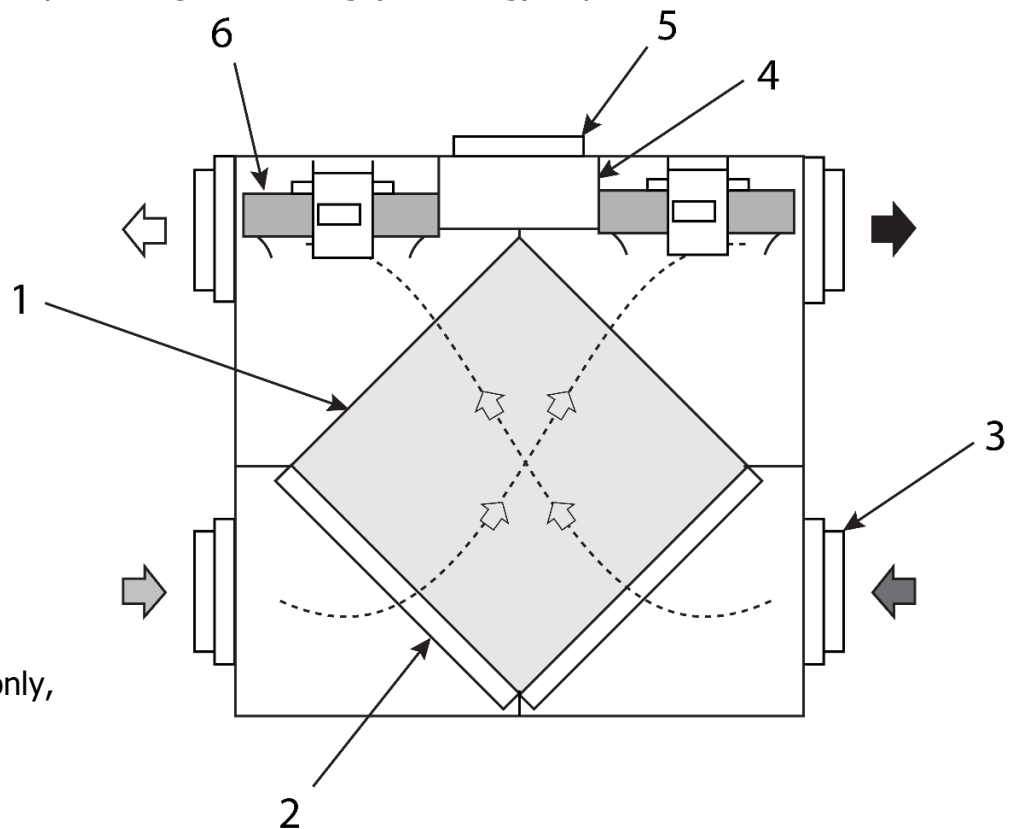

Attention

- Due to ongoing research and product development, specifications, ratings, and dimensions are subject to change without notice. Refer to www.lifebreath.com for the latest product information.



Warning

- Disconnect the power from the unit before cleaning or servicing.
- To prevent electrical shock, it is extremely important to confirm the polarity of the power line that is switched by the safety (disconnect) switch. The hot line (black) is the proper line for switching. Use either a voltmeter or test lamp to confirm the absence of a voltage between the disconnect switch and ground (on the cabinet) while the door is open. This procedure must be followed, as dwellings are occasionally wired improperly. Always ensure the proper grounding of the unit.

Table of Contents

1	Controlling Your HRV/ERV	3
2	Selecting the Ventilation that is Right for You	4
3	How the Dehumidistat Works	5
4	Main Wall Controls	6
5	Timers and Repeaters	5
6	Maintenance Instructions	7
7	Troubleshooting.....	9
8	Limited Warranty	11

Warranty Information

The Lifebreath Series HRVs carry a Lifetime Warranty on the heat recovery core and a 5-year replacement parts warranty. For full warranty terms, refer to the last page in this manual. Register for your warranty at <https://www.lifebreath.com/homeowners/warranty/>.



1 CONTROLLING YOUR HRV/ERV

Today's modern, tight buildings require fresh outdoor air to maintain a healthy indoor air environment. The amount of ventilation you require in the building will depend upon:

- The number of occupants and their activity levels
- The way the building was built
- Your personal preferences for fresh air

A Heat Recovery Ventilator (HRV) or Energy Recovery Ventilator (ERV) is an air-to-air energy exchanger found in modern, energy efficient homes. Due to the tight construction of new homes, your home can no longer "breathe" on its own. An HRV/ERV allows for fresh air exchange by exhausting stale indoor air and supplying an equal volume of fresh air from outside, ensuring high quality indoor air year-round.

- An HRV will transfer a high percentage of heat to the cooler air stream lessening the load on your heating and cooling appliances.
- An ERV will transfer a high percentage of heat as well as moisture to the cooler air stream lessening the load on your heating and cooling appliances. Ideal for environments with high outdoor humidity and a drier indoor environment.

An HRV/ERV that is properly installed, operated, and maintained will:

- Exhaust stale, contaminated air
- Recover the majority of the energy from the exhausted stale air
- Use the recovered energy to preheat or precool outside air that is drawn into the building
- Distribute the fresh air throughout the building
- Mitigate high indoor humidity during the cooler winter months of the year by exchanging the humid indoor air with the drier air from outside.
- Automatically cycles through its defrost mode when temperatures drop below freezing to avoid frost build up in the core

Each time the HRV/ERV is powered/energized, the self-test function automatically initiates. The unit cycles through the available speeds and tests the damper motor operation. The unit resumes operations at the selected mode and speed (approximately 60 seconds in duration).

Optional timers may be installed at specific exhaust locations (i.e., bathroom) to initiate high speed ventilation.

During seasons when your windows and doors are closed (winter, and summer if air conditioned), the HRV/ERV should be set to operate continuously on low speed with the option of going to high speed as the need arises. For example, if you are entertaining and there are a number of people present, the unit should be switched temporarily to high speed.

HRV/ERV Setting	Description	Result
Standby (fan speed set to 0 or OFF)	Allows unit to run on demand from remote controls such as a timer or dehumidistat.	Good
Intermittent low speed operation 20 ON / 40 OFF	Provides 20 minutes air exchange and 40 minutes off.	Better
Continuous LOW fan speed operation	Ensures continuous air exchange within the building. Air is always fresh and healthy.	Best

2 SELECTING THE VENTILATION THAT IS RIGHT FOR YOU

Operating Modes

The modes of operation and speeds are used to adjust your indoor ventilation rate. Experiment with the ventilation levels in your home to evaluate the ideal amount of ventilation to suit your home and personal preferences. Operational modes available to you will depend on the main control that is installed. Some features and modes may be unavailable to you.

1) Continuous Ventilation

This mode of operation provides continuous ventilation within the home. You may, for example, select Continuous Ventilation at low speed for normal operation and increase to high speed during increased activity levels, such as cooking and showering, etc.

2) 20 Minutes On, 40 Minutes Recirculation 20/hr 40/hr

This mode ventilates for 20 minutes and recirculates the household air every 40 minutes each hour. This mode is not applicable if your HRV/ERV is connected to a forced air system.

3) 20 Minutes On, 40 Minutes Standby 20/hr 40/hr

This mode of operation provides 20 minutes of ventilation each hour. You can use this ventilation mode at low speed for low household activity levels or when the home is unoccupied.

4) 10 Minutes On, 50 Minutes Standby 10/hr 50/hr

This mode of operation provides 10 minutes of ventilation each hour. You can use this ventilation mode at low speed for low household activity levels or when the home is unoccupied. This mode is useful when 20/40 mode is providing too much ventilation.

5) Continuous Recirculation

This mode continuously recirculates your household air (no ventilation). This mode is not applicable if your HRV/ERV is connected to a forced air system.

6) Continuous Low Fan Speed **LO**

This mode will operate the fan in low speed continuously at the selected operating mode (Ventilation or Recirculation)

7) Continuous High Fan Speed **HI**

This mode will operate the fan in high speed continuously at the selected operating mode (Ventilation or Recirculation). This mode is useful when occupancy in the home or activity is high for an extended period.

Recirculation

Recirculates existing household air without introducing fresh air. Recirculation modes (2 and 5) are not applicable if your HRV/ERV is connected to a forced air system, since your forced air system already circulates the household air. Recirculation modes are unavailable on some models.

3 HOW THE DEHUMIDISTAT WORKS

During the heating (winter) season, high indoor humidity levels have become a problem in many well insulated, tight homes. Excessive condensation on the window is a visual sign of high indoor humidity levels. High indoor humidity levels can result in mold and mildew and the eventual degradation of the building structure itself.

Your HRV/ERV reduces indoor humidity levels when the outdoor air is drier than the indoor air. These conditions usually occur during the heating season when outdoor temperatures are less than 15°C (59°F). During the heating season, the operation of the HRV/ERV may reduce indoor humidity levels sufficiently to eliminate the need for further dehumidification. If your home requires further dehumidification, use the Dehumidistat feature located on the wall control. High speed ventilation will be initiated upon exceeding the Dehumidistat set point regardless of the mode and speed of operation. Once the humidity in the building is reduced, the HRV/ERV will revert to its previous setting. The Dehumidistat function should be set to off for all seasons except the heating season because a dehumidifying effect occurs only when the outdoor air is drier than the indoor air.

We suggest operating the HRV/ERV for the first few days without using the Dehumidistat function to observe if further dehumidification is required. The Dehumidistat operates in percentage of relative humidity (% RH), with 60 being high and 20 being low. If, after a few days, further dehumidification is required (i.e., the building is still too humid), set the humidity level to a lower amount.

The average person is comfortable between 30% RH and 50% RH. The Dehumidistat should be set to off for all seasons except the heating season.



Note

- Only certain main wall controls are equipped with an adjustable Dehumidistat.
- **Dehumidistat Disable** automatically disables the Dehumidistat function on the main wall control when outdoor temperatures exceed 15°C (59°F) for a full 24-hour period. All other HRV features, and functions operate normally while the Dehumidistat function is disabled.
- **Dehumidistat Re-enable** automatically re-enables the Dehumidistat function if either the outdoor temperature drops below 15°C (59°F) for a full 24-hour period or if the HRV is reset (unplugged for 30 seconds).

4 MAIN WALL CONTROLS

Ventilation Wall Control (99-BC02) Operating Instructions:

- (1) ON/OFF Button
- (2) Humidistat Button
- (3) Fan Button
- (4) Fan Speed Indicator
- (5) Humidity Setting
- (6) ON/OFF light

Turning on the Control:

Press the ON/OFF Button . The ON/OFF light will illuminate.



Setting the Ventilation Speed:

Press the Fan Button  to select LOW or HIGH fan speed. The corresponding indicator light will illuminate. If both LO and HI indicator lights are off, the fan is OFF, but will turn ON if required by the Dehumidistat or remote timer (if installed).

Humidity Control:

Your unit will reduce indoor humidity when outdoor humidity levels are lower than indoor humidity levels. This feature is only effective when the outdoor temperature is below 59°F (15°C).

Setting the Dehumidistat:

Press the Dehumidistat button  until the dehumidistat indicator light is at the desired humidity setting. After a few seconds the dehumidistat indicator light will either flash or be on continuously. A flashing light indicates the humidity level is higher than the humidity setting, and the unit is operating on high speed ventilation. A continuous light indicates the humidity level is lower than the humidity setting. The Dehumidistat will override the current speed setting to HIGH speed. The Dehumidistat function can be turned off by pressing the button  until the dehumidistat indicator light turns off.

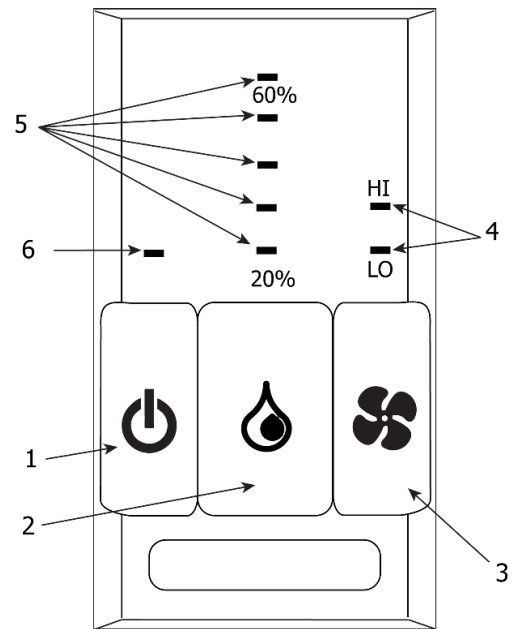

Attention

- Only one main control can be installed on your system.
- Recirculation is not available on all models.
- Timers will not function when mode of operation is set to "OFF", unless specifically installed for the function. (See Installation Guide for other options.)

4 MAIN WALL CONTROLS

Ventilation Wall Control (99-BC03)

Operating Instructions:

- (1) ON/OFF Button
- (2) Dehumidistat Button
- (3) Mode Button
- (4) Recirculation Mode Indicator
- (5) 20/40 Mode Indicator
- (6) Humidity Setting
- (7) LOW Fan Speed Indicator



Turning on the Control:

Press the ON/OFF Button . The LOW fan speed indicator will illuminate, and fan will turn to LOW speed.

Humidity Control:

Your unit will reduce indoor humidity when outdoor humidity levels are lower than indoor humidity levels. This feature is only effective when the outdoor temperature is below 59°F (15°C).

Setting the Dehumidistat:

Press the Dehumidistat Button  until the dehumidistat light is at the desired setting. After a few seconds the dehumidistat light will either flash or be on continuously. A flashing light indicates the humidity level is higher than the set point and that the unit is operating on HIGH speed ventilation. A continuous light indicates the humidity level is lower than the set point. The Dehumidistat will override the current speed setting to HIGH speed. The Dehumidistat function can be turned off by pressing the Dehumidistat Button  until the dehumidistat light turns off.

Setting the 20/40 Mode:

Press the Mode Button  until the 20/40 mode indicator light is illuminated. The 20/40 mode is a repeating cycle. The fan will run at LOW speed for 20 minutes, then turn OFF for 40 minutes. Some units are equipped to recirculate the air in your home during the 40-minute cycle with no ventilation. The control will automatically detect this feature and recirculate the air during the 40-minute cycle at LOW fan speed.

Recirculation Mode:

Some units are equipped to recirculate the air in your home without ventilating. Press the Mode Button  until the recirculation mode indicator light illuminates. Recirculation is in LOW speed.

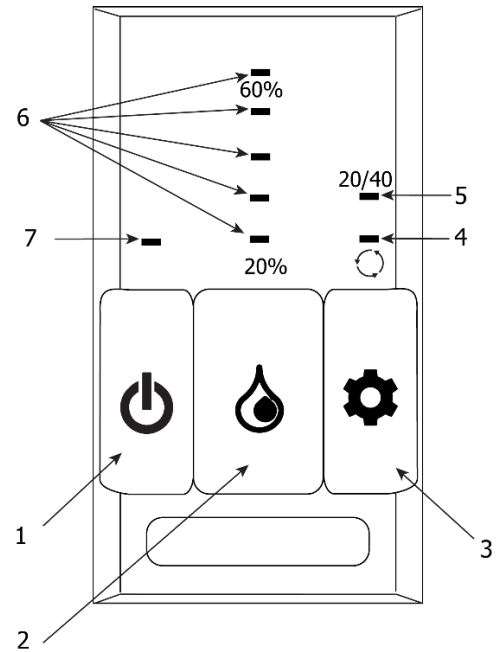

Attention

- Only one main control can be installed on your system.
- Recirculation is not available on all models.
- Timers will not function when mode of operation is set to "OFF", unless specifically installed for the function. (See Installation Guide for other options.)

4 MAIN WALL CONTROLS

Ventilation Wall Control (99-BC04)

Operating Instructions:

- (1) ON/OFF Button
- (2) 20/40 Button
- (3) Fan Button
- (4) Fan Speed Indicator
- (5) 20/40 Mode Indicator
- (6) ON/OFF Indicator

Turning on the Control:

Press the ON/OFF Button . The ON/OFF indicator light will illuminate.

Setting the Ventilation Speed:

Press the Fan button  to select LOW or HIGH fan speed. The corresponding indicator light will illuminate. If both LO and HI indicator lights are off, the fan is OFF, but will turn ON if required by a remote timer (if installed).

Setting the 20/40 Mode:

After a fan speed has been selected, press the 20/40 button. The 20/40 mode indicator light will illuminate. The 20/40 mode is a repeating cycle. The fan will run at LOW or HIGH speed for 20 minutes, then turn OFF for 40 minutes. Some units are equipped to recirculate the air in your home during the 40-minute cycle with no ventilation. The control will automatically detect this feature and recirculate the air during the 40-minute cycle at the selected fan speed.

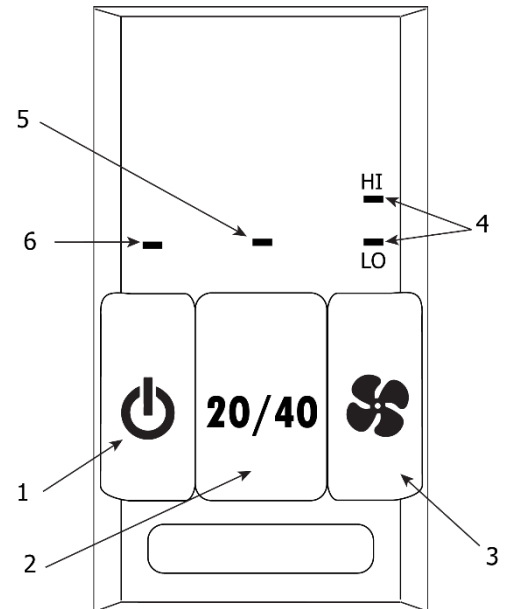

Attention

- Only one main control can be installed on your system.
- Recirculation is not available on all models.
- Timers will not function when mode of operation is set to "OFF", unless specifically installed for the function. (See Installation Guide for other options.)

4 MAIN WALL CONTROLS

Digital Wall Control (99-DXPL02)



Operating Instructions:

- (1) ON/OFF Button
- (2) Fan Speed Button
- (3) 20/40/60 High Speed Button
- (4) Mode Button
- (5) Dehumidistat Button
- (6) RESET Button
- (7) Instruction Card

Turning on the Control:

Press the ON/OFF Button . The light above will illuminate.

Setting the Ventilation Speed:

Press the Fan Button  to select one of the 5 available fan speeds. The fan speed will be displayed on the screen beside the Fan symbol . Standby mode (Fan OFF) is indicated as speed 0. The fan will turn ON if required by a remote timer (if installed).

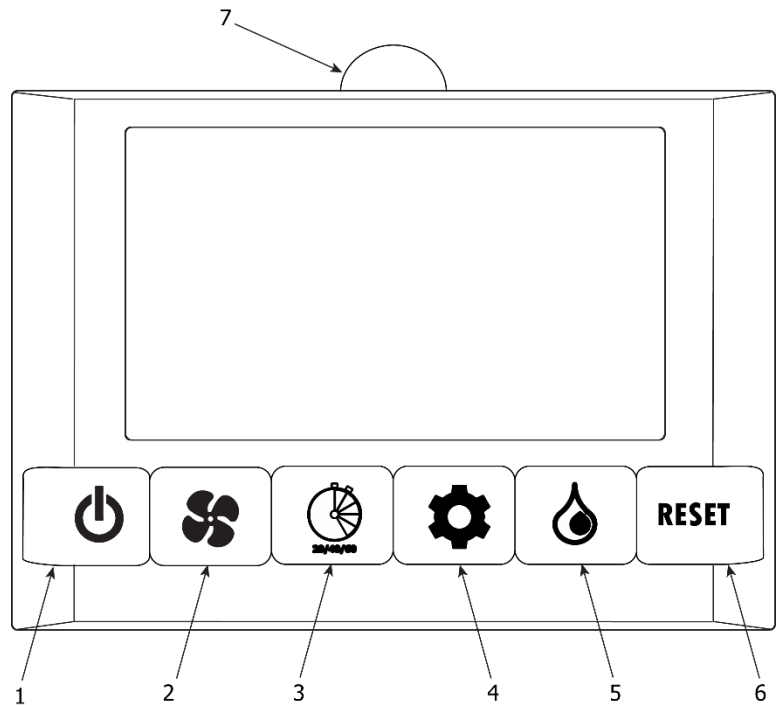

20/40/60 High Speed Button:

Press the 20/40/60 High Speed Button  to temporarily initiate HIGH Fan Speed for 20, 40, or 60 minutes.

- Press one time for 20 minutes
- Press two times for 40 minutes
- Press three times for 60 minutes
- Press four times to disable.

The  will appear on the screen and the corresponding section of the clock will flash to indicate the time interval selected. When the timer runs out, the unit will return to its previous operating fan speed.



Attention









- Only one main control can be installed on your system.
- Recirculation is not available on all models.
- Timers will not function when mode of operation is set to "OFF", unless specifically installed for the function. (See Installation Guide for other options.)

4 MAIN WALL CONTROLS

Digital Wall Control (99-DXPL02) Operating Instructions (cont.):

Setting the Mode of Operation:

There are 5 modes of operation available with this control. Press the Mode Button  to cycle through the different modes of operation:

- Continuous Ventilation 
- 20 min. Ventilation / 40 min. Recirculation  20/hr  40/hr
- 20 min. Ventilation / 40 min. OFF  20/hr  40/hr
- 10 min. Ventilation / 50 min. OFF  10/hr  50/hr
- Continuous Recirculation 



Setting the Dehumidistat:

Press the Dehumidistat Button  to adjust the Dehumidistat set point. The Dehumidistat can be set between 20% RH and 60% RH. The digital wall control displays the current indoor humidity in LARGE numbers and the Dehumidistat setting in SMALL numbers on the screen. If the indoor humidity is above the set point, the digital wall control will initiate HIGH Fan speed operation in Ventilation mode until the indoor humidity has been reduced below the set point.

Reset Button:

The RESET Button will clear the current Fan, Timer, Mode, and Dehumidistat settings set the unit into LOW fan speed, Ventilation Mode, and set the Dehumidistat set point to 40% RH.

Service Indicator:

A service indicator  appears when the unit requires routine maintenance. Refer to [Maintenance Instruction](#). Press and hold the ON/OFF button  for 5 seconds to reset the service indicator after routine maintenance has been performed.

5 TIMERS AND REPEATERS

Depending on the type of HRV/ERV installation, you may have timers in areas such as restrooms. The timer will override the operational mode (regardless of the setting) and initiate HIGH fan speed Ventilation. Upon completion of the timer cycle, the HRV/ERV will return to your selected operational mode and fan speed setting.

20/40/60 Minute Wireless Timer (99-DET02):

- (1) Select Button
- (2) 20/40/60 minute status lights
- (3) Red LED battery indicator

Press the Select Button on the timer to initiate high speed ventilation for 20, 40, or 60 minutes. The 20/40/60 minute status lights indicate high speed operation. To cancel the high speed fan operation, press the Select Button until the 20/40/60 minute status lights are no longer illuminated.

When the battery in the timer needs to be replaced, the red LED Battery Indicator will illuminate.

When paired to the digital wall control, the wireless timer may be moved to a remote location in the home such as a bathroom. Wireless timers have an estimated range of 40 ft with no obstructions.

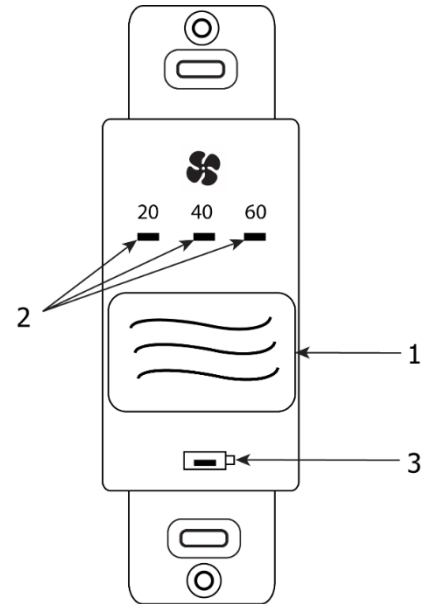

Replacing the Timer Battery:

- (4) Battery
- (5) Face plate
- (6) Back plate

- a) Remove the face plate by separating it from the back plate. On the back of the face plate the battery will be exposed.
- b) Replace the battery and re-attach the face plate to the back plate.

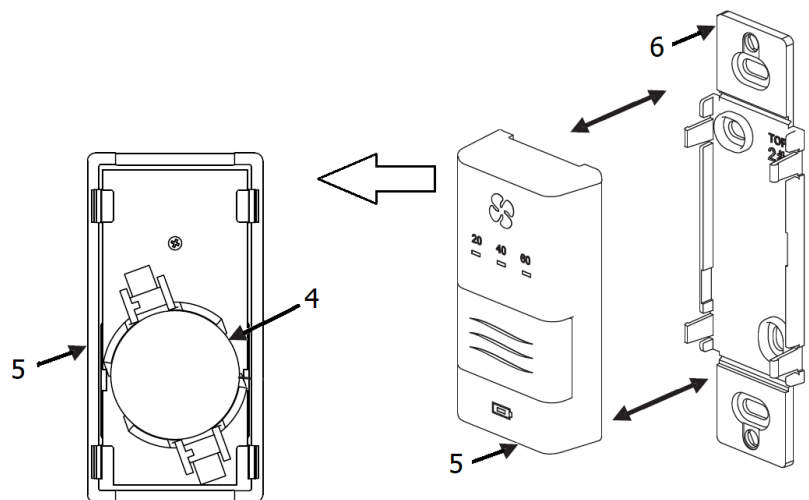

Attention

- Be careful not to damage the tabs on the back plate when re-attaching the face plate.

5 TIMERS AND REPEATERS

20/40/60 Minute Timer (99-DET01):

- (1) Select Button
- (2) 20/40/60 minute status lights

Press the Select Button on the timer to initiate high speed ventilation for 20, 40, or 60 minutes. The 20/40/60 minute status lights indicate high speed operation.

Lockout mode is useful if you wish to disable the timer:

- Enable Lockout Mode by holding the Select Button for 5 seconds.
- Disable Lockout Mode by holding the Select Button for 5 seconds.

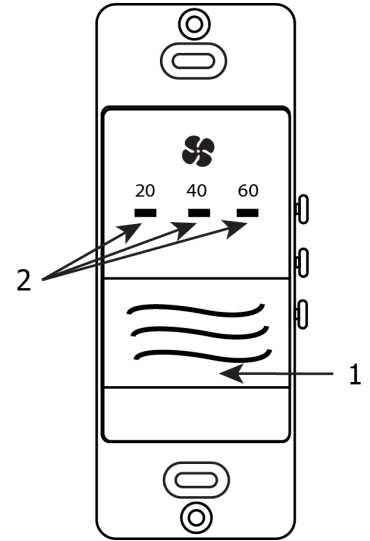

Wireless Repeater (99-RX02):

- (1) Green LED
- (2) Red LED
- (3) Power Plug

The wireless repeater is used to extend the range of the 99-DET02 wireless timers. The repeater plugs directly into a 120V power outlet. The 99-RX02 repeater wireless connects to the main control as well as the 99-DET02 wireless timers.

The 99-RX02 repeater should be installed at the halfway point between the 99-DET02 wireless timer and the main control if the timer is out of range. The LED will indicate the repeater's connection strength to the main control per the table below. Re-adjust the repeater's position as necessary.

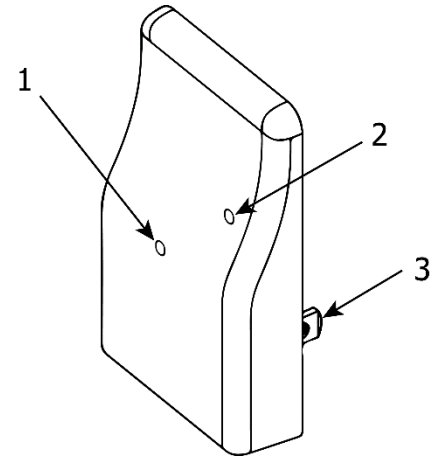

LED Colour	Connection	Action
Solid Green	Good	No further adjustments are required.
Flashing Green	Moderate	The repeater will function properly but shouldn't be moved further away from the main control.
Red	Bad	The repeater needs to be moved closer to the main control.

6 MAINTENANCE INSTRUCTIONS

Several maintenance procedures are required to keep your HRV/ERV in good working order. The table below provides the required maintenance, service interval, and procedural steps.

Table 4.1 - Maintenance Procedures

Type	Interval	Procedure
Inspect Exterior Hoods	Monthly	Make sure the exhaust and fresh air supply hoods are not blocked or restricted by leaves, grass, or snow. In winter, it is especially important to make sure snow is not blocking the hoods or that frost has not built up on the wire mesh (bird screen).
Clean Air Filters	Quarterly	<div data-bbox="646 558 1455 688" style="border: 1px solid black; padding: 5px; margin-bottom: 10px;"> <p>! Note</p> <ul style="list-style-type: none"> The standard air filters equipped with your HRV/ERV are removable and washable. </div> <ol style="list-style-type: none"> 1) Open access door. 2) Carefully grip the ends of the core and pull evenly outward. The core may be snug but will slide out of the cabinet. 3) Remove the filter clips (if installed) and then the air filters. <div data-bbox="646 863 1455 1031" style="border: 1px solid black; padding: 5px; margin-bottom: 10px;"> <p>! Caution</p> <ul style="list-style-type: none"> Do not wring out the air filters or clean them in the dishwasher. Do not wash the air filters with hot water. </div> <ol style="list-style-type: none"> 4) Rinse the air filters with cold water or a combination of mild soap and water. Shake them once or twice to remove excess water. 5) Install the clean filter(s) (wet or dry) back into their positions against the core and install the filter clips, if present. 6) Slide core back into its original position.



Warning

- Electric shock hazard. Can cause injury or death. Before attempting to perform any service or maintenance, turn the electrical power unit off at the disconnect switch(es). Unit may have multiple power supplies.
- Blockage of hoods may cause an imbalance.

6 MAINTENANCE INSTRUCTIONS

Several maintenance procedures are required to keep your HRV/ERV in good working order. The table below provides the required maintenance, service interval, and procedural steps.

Table 4.1 - Maintenance Procedures (cont.)

Type	Interval	Procedure
Clean Core	Biannually	<p>1) Open access door.</p> <p>2) Carefully grip the ends of the core and pull evenly outward. The core may be snug but will slide out of the cabinet.</p> <p>3) Remove the air filters.</p> <div data-bbox="657 554 1466 800" style="border: 1px solid black; padding: 5px;"> <p>! Attention</p> <ul style="list-style-type: none"> • Do not use cleaning solutions. • Do not use bleach or chlorine. • Do not use a pressure washer. • Do not wash an ERV core. • Do not place the core in a dishwasher. • The installation label is on the outer end of the core. </div> <p>4) Clean the HRV or ERV core, as applicable:</p> <ul style="list-style-type: none"> ○ HRV: Soak and rinse core in warm and soapy water. ○ ERV: Clean core gently with a vacuum. DO NOT WASH. <p>5) Install the clean air filters.</p> <p>6) Position the bottom of the core on the bottom support in the cabinet.</p> <div data-bbox="657 1052 1466 1220" style="border: 1px solid black; padding: 5px;"> <p>! Note</p> <ul style="list-style-type: none"> • The core may appear to stick out from the cabinet approximately 1/8 in. (3 mm). This is designed this way so that the access door will fit tight against the core. </div> <p>7) Carefully align the core with the three other supports and fully insert the core. Push on the sides of the core. Do not push on the centre.</p>
Motor	N/A	The motor is maintenance free.
Clean Drain (Condensate) Line	Annually	Inspect the drain line (if applicable), drain spout, and P-trap for blockage, molds, or kinks. Flush with warm soapy water. Replace if worn, bent, or unable to clean.
Clean Duct Work	As necessary	The duct work running to and from the HRV/ERV may accumulate dirt. Wipe and vacuum the duct once every year. You may wish to contact a heating/ventilation company to do this.
General Maintenance	Biannually	Wipe down the inside of the cabinet with a damp cloth to remove any dirt, bugs, and debris.

7 TROUBLESHOOTING

Refer to the following table for troubleshooting your HRV/ERV unit.

Table 5.1 – Troubleshooting Procedures

SYMPTOM	CAUSE	SOLUTION
Flashing light on the timer and/or main control	<ul style="list-style-type: none"> Usually a wiring, voltage, or communication error. 	<div style="border: 1px solid black; padding: 5px; margin-bottom: 5px;"> <p>Note</p> <ul style="list-style-type: none"> Some older style controls will display flashing lights to indicate that a mode, such as defrost, has been enabled. </div> <ul style="list-style-type: none"> Cycle the power by turning off and disconnecting the unit for 30 seconds, then reconnect and turn it on. If the problem persists, contact your service contractor.
Poor airflows	<ul style="list-style-type: none"> 1/4 in (6 mm) mesh on outside hood is plugged Filters plugged Core obstructed House grilles closed or blocked Dampers are closed if installed Poor power supply at site Ductwork is restricting HRV/ERV Improper speed control setting HRV/ERV airflow improperly balanced 	<ul style="list-style-type: none"> Clean exterior hoods or vents Remove and clean filter Remove and clean core Check and open grilles Open and adjust dampers Have electrician check supply voltage Check duct installation Increase the speed of the HRV/ERV Have contractor balance HRV/ERV
Supply air feels cold	<ul style="list-style-type: none"> Poor location of supply grilles, the airflow may irritate the occupant Outdoor temperature extremely cold 	<ul style="list-style-type: none"> Locate the grilles high on the walls or under the baseboards, install ceiling mounted diffuser or grilles so as not to directly spill the spill air on the occupant (eg. over a sofa) Turn down the HRV/ERV supply speed. A small duct heater (1kw) could be used to temper the supply air. Placement of furniture or closed doors is restricting the movement of air in the home If supply air is ducted into the furnace return, the furnace fan may need to run continuously to distribute ventilation air comfortably
Dehumidistat in not operating	<ul style="list-style-type: none"> Outdoor temperature is above 15°C (59°F) Improper low voltage connection External low voltage is shortened out by a staple or nail. Check Dehumidistat setting, it may be on OFF 	<ul style="list-style-type: none"> Dehumidistat is functioning normally (see Auto Dehumidistat Disable in this manual) Check that the correct terminals have been used. Check external wiring for a short. Set the Dehumidistat at the desired setting

7 TROUBLESHOOTING

Refer to the following table for troubleshooting your HRV/ERV unit.

Table 5.1 – Troubleshooting Procedures (cont.)

SYMPTOM	CAUSE	SOLUTION
Humidity levels are too high, and condensation is appearing on the windows	<ul style="list-style-type: none"> Dehumidistat is set too high HRV is not sized to handle a hot tub, indoor pool etc. Lifestyle of the occupants Moisture coming into the home from an unvented or unheated crawl space Moisture is remaining in the washroom and kitchen areas Condensation seems to form in the spring and fall HRV is set at too low a speed 	<ul style="list-style-type: none"> Set Dehumidistat lower Cover pools, hot tubs when they are not in use Avoid hanging clothes to dry, storing wood and venting clothes dryer inside. Firewood may have to be moved outside Vent crawl space and place a vapor barrier on the floor of the crawl space Ducts from the washroom should be sized to remove moist air as effectively as possible, use of a bathroom fan for short periods will remove additional moisture. On humid days, as the seasons change, some condensation may appear, but the home's air quality will remain high with some HRV use
Humidity levels are too low	<ul style="list-style-type: none"> Dehumidistat control set too low Blower speed of HRV/ERV is too high Lifestyle of occupants HRV/ERV airflows may be improperly balanced 	<ul style="list-style-type: none"> Set Dehumidistat higher Decrease HRV/ERV blower speed Humidity may have to be added using humidifiers Have contractor balance HRV/ERV airflows
HRV/ERV and/or ducts frosting up	<ul style="list-style-type: none"> HRV/ERV airflows are improperly balanced Malfunction of the HRV/ERV defrost system 	<div style="border: 1px solid black; padding: 5px; margin-bottom: 5px;"> <p>⚠ Note</p> <ul style="list-style-type: none"> Minimal frost build-up is expected on cores before unit initiates defrost cycle functions </div> <ul style="list-style-type: none"> Have HVAC contractor balance the HRV/ERV Ensure damper defrost is operating during self-test.
Condensation or ice buildup in insulated duct to the outside	<ul style="list-style-type: none"> Incomplete vapor barrier around insulated duct A hole or tear in outer duct covering 	<ul style="list-style-type: none"> Tape and seal all joints Tape any holes or tears made in the outer duct covering Ensure that the vapor barrier is completely sealed
Excess water in the bottom of the HRV	<ul style="list-style-type: none"> Drain pans plugged Improper connection HRV's drain lines HRV is not level Drain lines are obstructed HRV heat exchange core is not properly installed 	<ul style="list-style-type: none"> Look for obstructions in the drain line Look for kinks in the drain line
Excessive Vibration	<ul style="list-style-type: none"> Dirt on fan wheels 	<ul style="list-style-type: none"> Have contractor service HRV/ERV

8 LIMITED WARRANTY

AIRIA BRANDS INC.® (AIRIA) warrants to the original purchaser of the LIFE BREATH® model and accessories referred to below, to be free from manufacturing defects.

This Limited Warranty is personal to AIRIA® and is in effect from the installation date, but no later than 12 months after the date the product was manufactured (if the installation date cannot be verified, the warranty period will begin on the date of manufacture). The serial number can be used to determine the date of manufacture: XX XX MMDDYY ###; or MMDDYY ###. The warranty is dependent on the type of unit:

Type of Unit	Warranty
HRV Residential	Lifetime on the Core / 5 years on other components
HRV Commercial	15 years on the Core / 2 years on other components
ERV Residential	5 years on the Core / 5 years on other components
ERV Commercial	5 years on the Core / 2 years on other components
Accessories (e.g. controls and timers)	1 year
Replacement Parts (e.g. motor)	1 year
Clean Air Furnace (HRV)	Lifetime on the Core / 2 years on other components
Clean Air Furnace (ERV)	5 years on the Core / 2 years on other components
Air Handler	5 years
TFP	5 years

Damage resulting from all other causes, including but not limited to: lightning, hurricane, tornado, earthquake or any other acts of God; improper installation, modification, alteration or misuse of the LIFE BREATH® unit or its operation in a manner contrary to the instructions accompanying the unit at the time of sale; accidental or intentional damage, neglect, improper care, or other failure by the owner to provide reasonable and necessary maintenance of the product; any attempt at repair by an unauthorized service representative or not in accordance with this warranty; or any other causes beyond the control of AIRIA®, are excluded from this warranty.

If you feel that the LIFE BREATH® unit you purchased is not free from manufacturing defects, please refer to <https://www.lifebreath.com/homeowners-2/find-a-contractor/> to find the name of your nearest dealer in order to repair the product. The labour required to install any replacement part(s) is not covered by AIRIA®.

AIRIA® reserves the right to replace the entire unit or to refund the original purchase price in lieu of repair.

AIRIA® MAKES NO EXPRESS WARRANTIES, EXCEPT FOR THOSE SET FORTH HERIN AND SHALL NOT BE LIABLE FOR ANY INCIDENTAL, SPECIAL OR CONSEQUENTIAL DAMAGES WITH RESPECT TO LIFE BREATH® COVERED BY THIS WARRANTY. AIRIA'S COMPLETE LIABILITY AND THE OWNER'S EXCLUSIVE REMEDY BEING LIMITED TO REPAIR OR REPLACEMENT ON THE TERMS STATED HEREIN. ANY IMPLIED WARRANTIES, INCLUDING BUT NOT LIMITED TO THE IMPLIED WARRANTY OF MERCHANTABILITY AND OF FITNESS FOR ANY PARTICULAR PURPOSE, ARE EXPRESSLY EXCLUDED.

NO PERSON IS AUTHORIZED TO CHANGE THE WARRANTY IN ANY WAY OR GRANT ANY OTHER WARRANTY UNLESS SUCH CHANGES ARE MADE IN WRITING AND SIGNED BY AN OFFICER OF AIRIA®.

MODEL NO.: _____

UNIT SERIAL NO.: _____

INSTALLED BY: _____

DATE: _____