

# User Manual

B4000 SST

Solid-State Portable Power Station

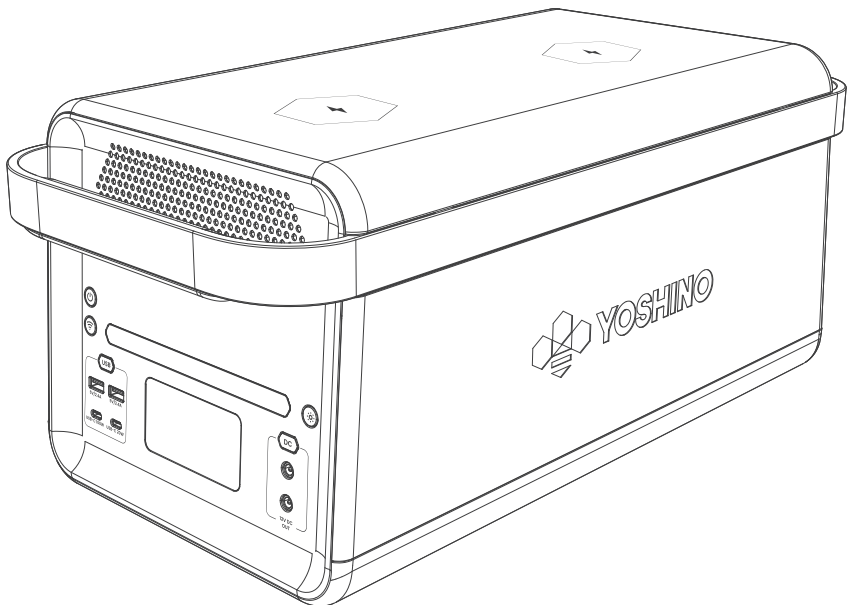

# DISCLAIMER

The information contained in this manual is subject to change without notice.

Read all safety tips, warning messages, terms of use, and disclaimers carefully. This user manual contains instructions and notes on the operation and use of this unit. Users take full responsibility for all usage and operations. You are solely responsible for being aware of all relevant regulations and using Yoshino products in a way that is compliant.

Yoshino recommends that you use genuine Yoshino accessories. Yoshino shall not be responsible for any damage or expense that might result from the use of parts other than genuine Yoshino parts.

If you are not going to use the unit for an extended period of time, power off the unit and disconnect AC adapter from the outlet. Recommended storage temperature: 32-104°F / 0-40°C, storage humidity: 90% Max. To protect the battery, charge the unit to 80% every 3-6 months during long-term storage.

For your safety, please read this manual carefully before using and keep handy for future reference.

# YOSHINO APP

You can use the Yoshino app to monitor, control or customize your portable power station.

Download at <https://YoshinoPower.com>

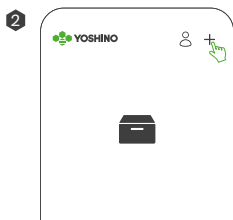
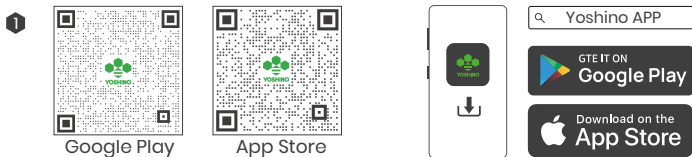

1. Add device

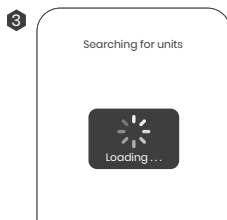

2. Search with Bluetooth

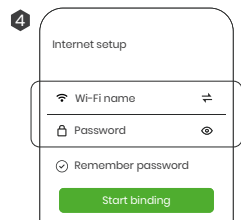

3. Connect to the Internet



Tech support based in the USA!

1 (800) 513-2797 [customersupport@YoshinoPower.com](mailto:customersupport@YoshinoPower.com)

Operating hours are 8:00 am - 4:30 pm PST (M-F).

# CONTENT

<b>1. What's in the Box</b>	<b>02</b>
<b>2. Safety Instructions</b>	<b>03-04</b>
<b>3. Overview</b>	<b>05-06</b>
<b>4. Recharging Your Portable Power Station</b>	<b>07</b>
4.1 AC Charging	07
4.2 Car Charging	07
4.3 Solar Charging	08
<b>5. Operation</b>	<b>08</b>
5.1 Power Button	08
5.2 APP Connectivity	08
5.3 LED Light Bar	09
5.4 AC Output	09
5.5 USB Output	09
5.6 DC Output	10
<b>6. UPS</b>	<b>10</b>
<b>7. Smart Link Technology – Expansion Battery</b>	<b>11</b>
<b>8. Specifications</b>	<b>12</b>
<b>9. Warranty</b>	<b>13-14</b>
<b>10. Troubleshooting</b>	<b>15</b>
<b>11. FAQ</b>	<b>16</b>
<b>12. FCC Warning</b>	<b>17</b>



Tech support based in the USA!

1 (800) 513-2797 [customersupport@YoshinoPower.com](mailto:customersupport@YoshinoPower.com)

Operating hours are 8:00 am – 4:30 pm PST (M-F).

# 1. What's in the Box

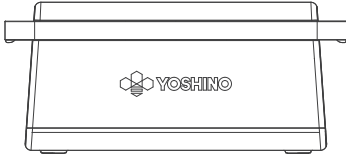

B4000 SST  
Portable Power Station

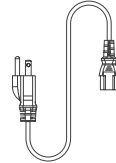

AC Recharge Cable  
( 5.9 ft / 1.8 m )

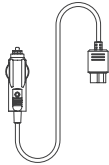

Cigarette Car  
Charging Cable  
( 9.8 ft / 3 m )

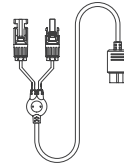

Solar Charging Cable  
MC4 to XT60  
( 9.8 ft / 3 m )

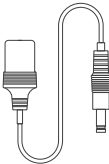

DC5521 to Cigarette Car  
Female Output Cable  
( 1.6 ft / 0.5 m )

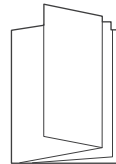

User Manual,  
Thank You Card,  
Warranty Registration Card



Tech support based in the USA!

1 (800) 513-2797 [customersupport@YoshinoPower.com](mailto:customersupport@YoshinoPower.com)

Operating hours are 8:00 am - 4:30 pm PST (M-F).

## 2. Safety Instructions

### Important Safety Instructions

WARNING – When using this product, basic precautions should always be followed, including the following:

- a) Read all the instructions before using the product.
- b) To reduce the risk of injury, close supervision is necessary when the product is used near children.
- c) **Do not** put fingers or hands into the product.
- d) Use of an attachment not recommended or sold by Yoshino Technology may result in a risk of fire, electric shock, or injury to persons.
- e) To reduce risk of damage to the electric plug and cord, pull the plug rather than the cord when disconnecting the portable power station.
- f) **Do not** use a portable power station or appliance that is damaged or modified. A damaged or modified portable power station may exhibit unpredictable behavior resulting in fire, explosion or risk of injury.
- g) **Do not** operate the portable power station with a damaged cord or plug, or a damaged output cable.
- h) **Do not** disassemble the portable power station, contact Yoshino customer service when service is required. Incorrect disassembly or reassembly may result in a risk of fire or electric shock.
- i) To reduce the risk of electric shock, unplug the power pack from the outlet before attempting any instructed servicing.
- j) When charging the internal battery, work in a well ventilated area and do not restrict ventilation in any way.
- k) **Do not** expose a portable power station to fire or excessive temperature. Exposure to fire or temperature above 130°C (265°F) may cause explosion.
- l) Have servicing performed by a qualified repair person using only identical replacement parts. This will ensure that the safety of the product is maintained.
- m) **Do not** get the product wet or immerse it in water. If water is found inside the product, it must not be turned on or used again. Take all precautions against shock before touching the product. Move the product to a safe open area. Once the product is safely moved, contact Yoshino customer service immediately.
- n) **Do not** use the product in an environment with strong static electricity/magnetic fields.
- o) **Do not** drop or allow the product to fall. If the product has any kind of severe external impact, turn the power off immediately and stop using the product. Dispose of the product properly.
- p) **Do not** put heavy objects on top of the product.
- q) **Do not** block the fan during use.
- r) This product is not recommended for powering medical emergency equipment such as medical grade ventilators and artificial lungs. Please consult with your doctor and the manufacturer for instructions on the safe use of portable power station with medical equipment.
- s) Please keep a safe distance between medical implants and this product while the product is in use. This portable power station will generate electromagnetic fields which can affect the normal operation of pacemakers, hearing aids, cochlear implants and other medical equipment. Please contact the manufacturer for information on the safe use of this product around these devices.



Tech support based in the USA!

1 (800) 513-2797 [customersupport@YoshinoPower.com](mailto:customersupport@YoshinoPower.com)

Operating hours are 8:00 am – 4:30 pm PST (M-F).

## Grounding Instructions

This product must be grounded. If it should malfunction or breakdown, grounding provides a path of least resistance for electric current to reduce the risk of electric shock. This product is equipped with a cord having an equipment grounding conductor and a grounding plug. The plug must be plugged into an outlet that is properly installed and grounded in accordance with all local codes ordinances.

**WARNING** – Improper connection of the equipment grounding conductor is able to result in a risk of electric shock. Check with a qualified electrician if you are in doubt as to whether the product is properly grounded. Do not modify the plug provided with the product – if it will not fit the outlet, have a proper outlet installed by a qualified electrician.

## Storage and Maintenance Instructions

1. Keep this product out of reach of children and pets.
2. Only use a clean dry cloth to remove dirt from the product ports.
3. If the portable power station is not going to be used for extended periods of time, power off the unit and disconnect the AC to DC recharge adapter from the outlet.
4. Store the product at 32-104°F / 0-40°C. Every 3-6 months charge the product to 80% to protect battery life.
5. Store the product in a dry and well ventilated place.

## Disposal Guide

1. If possible, fully discharge the battery before disposal in a designated battery recycling bin. It is strictly prohibited to dispose of this product in regular trash bins. Batteries contain chemicals that could be dangerous if not disposed of properly. Please consult your local laws and regulations on battery recycling and disposal.
2. Do not dispose of the battery in a battery recycling box if the battery cannot be fully discharged. Please contact a professional battery recycling company for help in disposing of the battery.
3. Batteries that cannot be recharged should be disposed of properly.



Tech support based in the USA!

1 (800) 513-2797 [customersupport@YoshinoPower.com](mailto:customersupport@YoshinoPower.com)

Operating hours are 8:00 am – 4:30 pm PST (M-F).

### 3. Overview

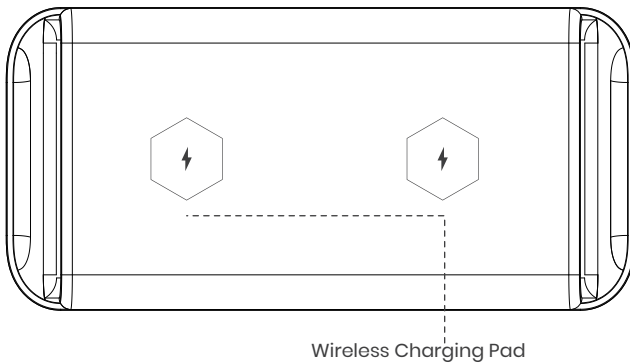
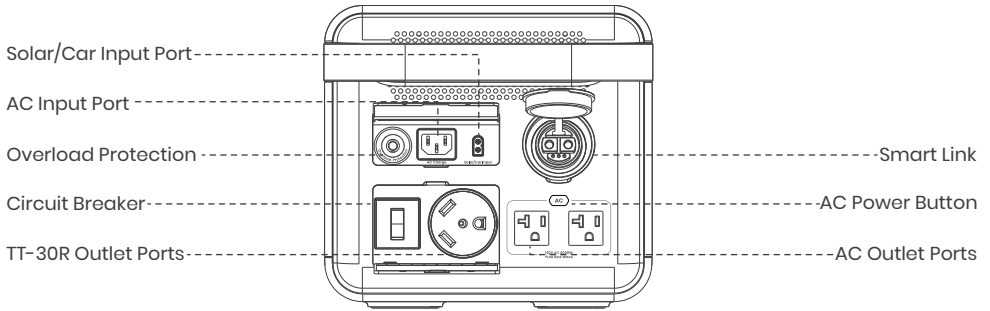
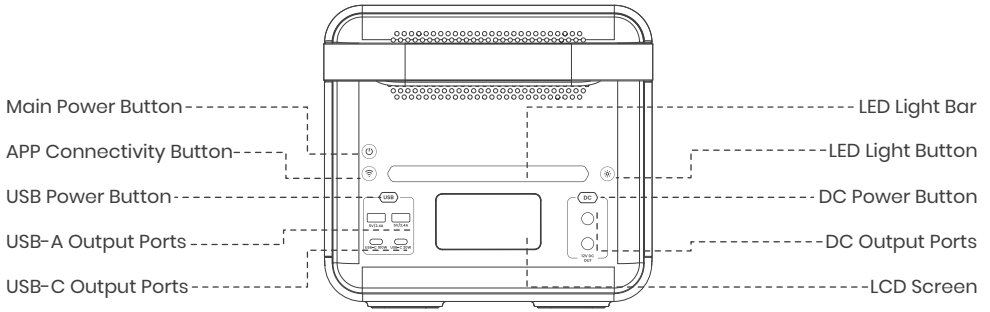

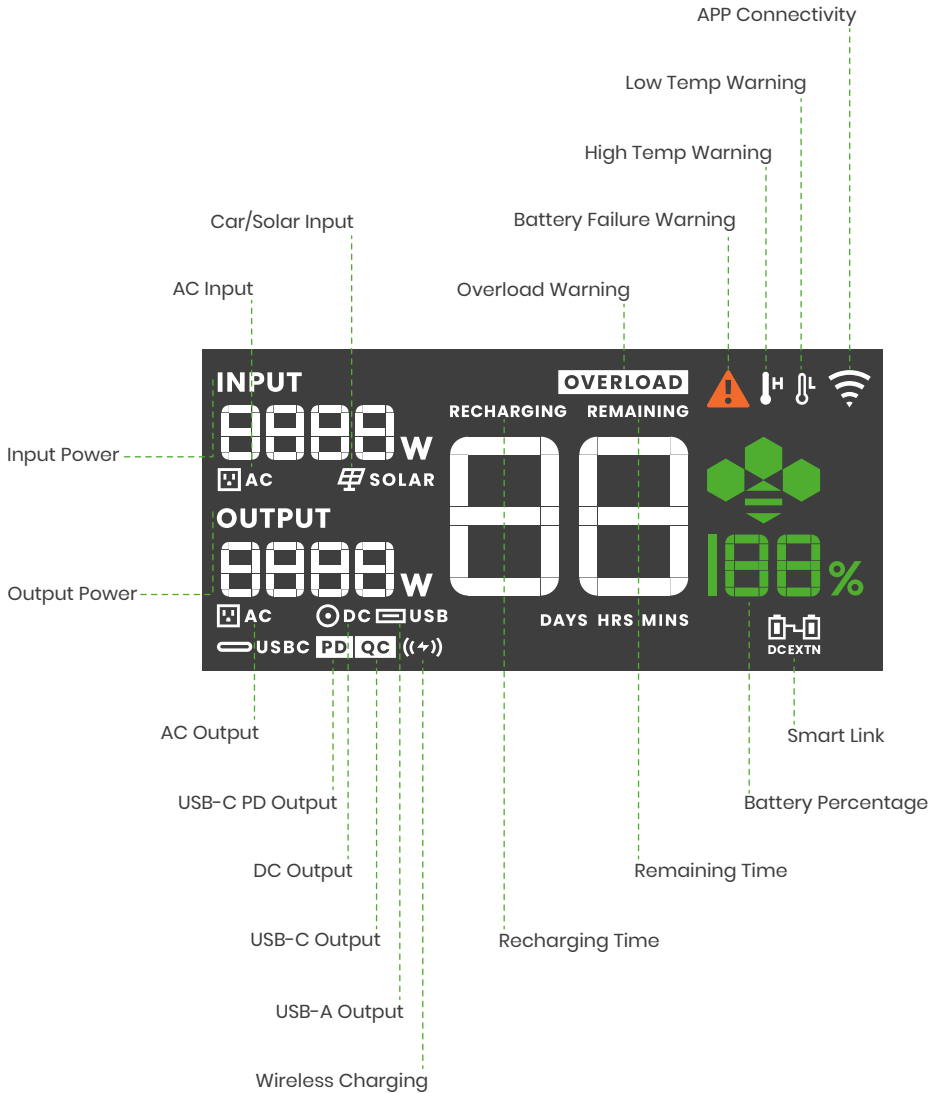

## LCD Screen Guide



Tech support based in the USA!

1 (800) 513-2797 [customersupport@YoshinoPower.com](mailto:customersupport@YoshinoPower.com)

Operating hours are 8:00 am - 4:30 pm PST (M-F).



## 4. Recharging Your Portable Power Station

### Note

Before use or storage, recharge your portable power station to full charge. If the LCD screen indicates less than 20% charge, recharge using available power input methods as soon as possible.

### 4.1 AC Charging

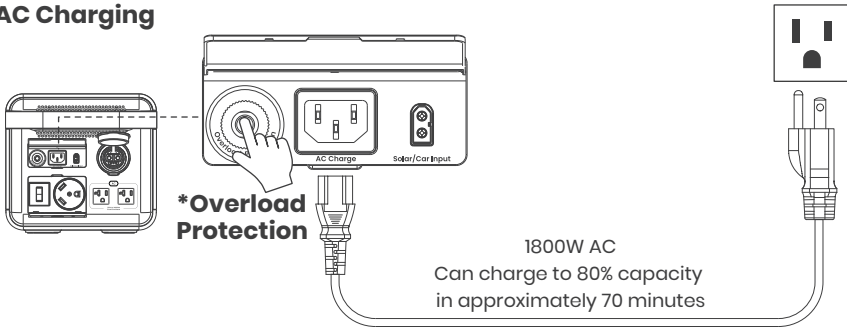

Please use the AC Charging Cable included in the package for fast charging. Plug directly into AC wall outlet and make sure that the wall outlet output voltage is 110–125V. Yoshino takes no responsibility for any consequences caused by failure to follow instructions, including but not limited to charging with other AC charging cables.

### \*Overload Protection

When AC recharging is not available, check to see if the overload protection switch is switched on. If so, press it down to reset.

### 4.2 Car Charging

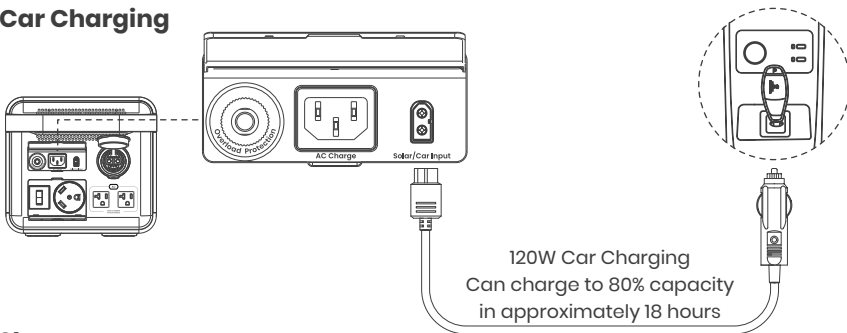

### Note:

- 1 Users can recharge the product through the use of 12V/10A car chargers.
- 2 Before use, check to see that the car charging cable is well connected.
- 3 Please make sure the car is started before using car charging. Yoshino takes no responsibility for any losses or damages caused by failure to follow instructions.



Tech support based in the USA!

1 (800) 513-2797 [customersupport@YoshinoPower.com](mailto:customersupport@YoshinoPower.com)

Operating hours are 8:00 am – 4:30 pm PST (M-F).

### 4.3 Solar Charging

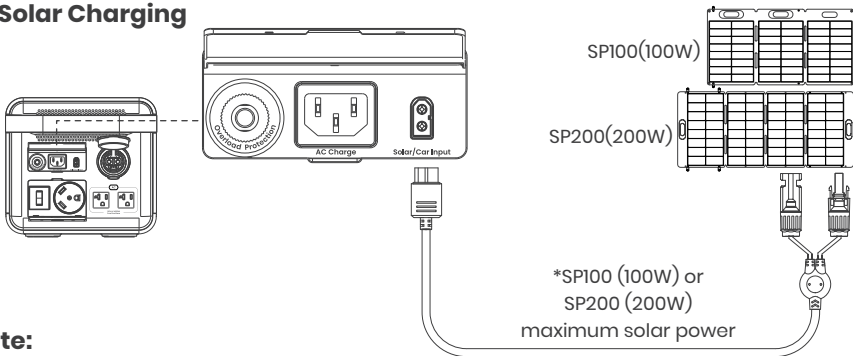

#### \*Note:

- 1 Yoshino SP100 (100W) or Yoshino SP200 (200W) solar panels (not included) can quickly charge the device to 80% in around 4.5 hours (Using 3 SP200 Solar Panels).
- 2 When using a Yoshino solar panel to charge the product, please follow the instructions that come with the solar panel.
- 3 Before connecting the solar panel, please ensure that the solar panel's output voltage is within 60V to avoid product damage.

## 5. Operation

### 5.1 Power Button

Press and hold the main power button for 2 seconds to turn on the product. The LCD screen will light up and the main power indicator will turn pulse white. Press and hold the main power button again for 2 seconds to turn the device off. The word "OFF" will appear on the screen, then the power indicator light and LCD screen will turn off.

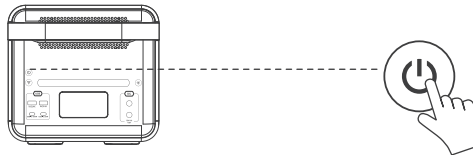

#### \*Note:

- 1 If the device does not operate for 1 minute, the LCD screen will turn off. When you start to use the product again, the LCD screen will turn on automatically.
- 2 When there is no usage within 1 hour, and all the output power buttons are turned off, the product will turn off automatically.

### 5.2 APP Connectivity



Press and hold the app connection button for 3 seconds until you hear a beep, then the icon will flash until it connects successfully. If the app fails to connect, the icon will go off.



Tech support based in the USA!

1 (800) 513-2797 [customersupport@YoshinoPower.com](mailto:customersupport@YoshinoPower.com)

Operating hours are 8:00 am - 4:30 pm PST (M-F).

### 5.3 LED Light Bar

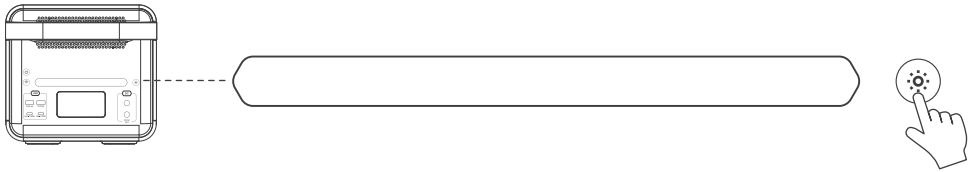

Press and hold the LED Light Button for 1.5 seconds until the LED light turns on. Press and hold the button for 1.5 seconds again to turn the LED light off.

### 5.4 AC Output

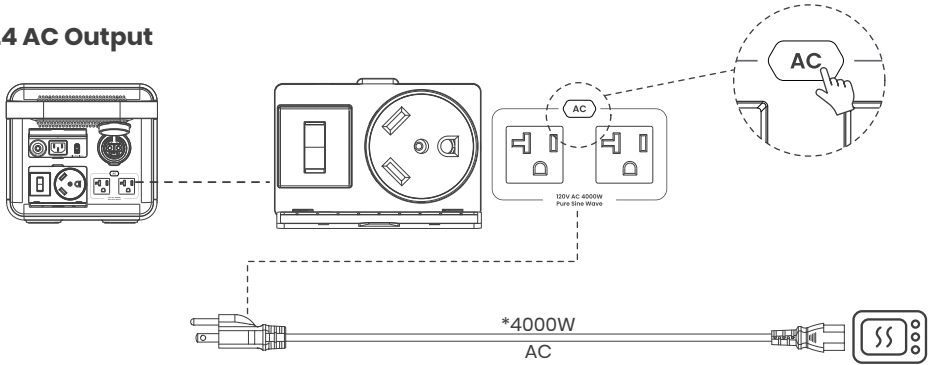

Press and hold the AC Power Button for 1.5 seconds until the button lights. Press and hold the button for 1.5 seconds again to turn off power to the AC outlets.

**\*Note:**

When the portable power station is connected to a refrigerator or other device that needs to have a continuous power supply, set the AC output to “Always on” in the app. If the portable power station is set to normal mode, the portable power station may automatically shut down due to power fluctuations.

### 5.5 USB Output

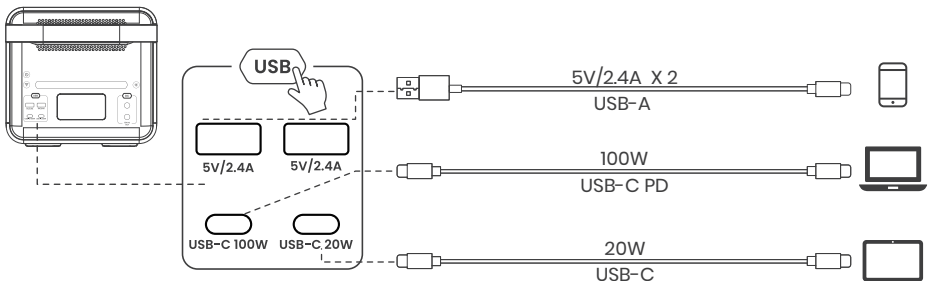

Press and hold the USB button for 1.5 seconds until the button lights. Press and hold the button for 1.5 seconds again to turn power off to the USB ports.



Tech support based in the USA!

1 (800) 513-2797 [customersupport@YoshinoPower.com](mailto:customersupport@YoshinoPower.com)

Operating hours are 8:00 am - 4:30 pm PST (M-F).

## 5.6 DC Output

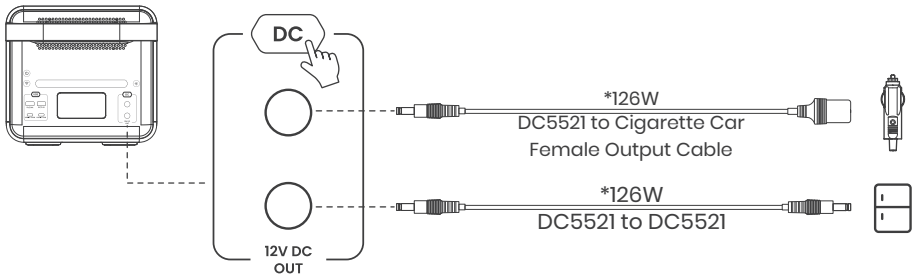

Press and hold the DC power button for 1.5 seconds until the button lights. Press and hold the button for 1.5 seconds again to turn power off to the DC ports.

**\*Output power total is 126W**

## 6. Uninterruptible Power Supply (UPS)

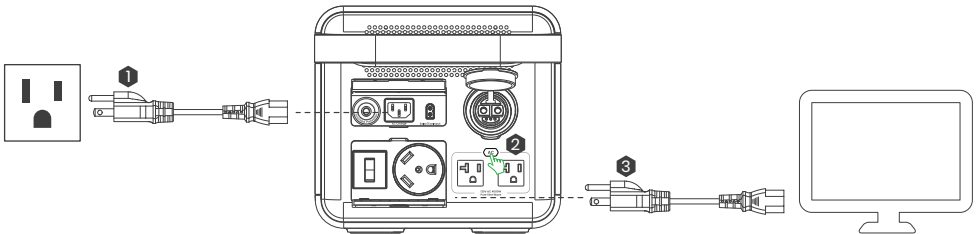

### Note

To use the UPS function, connect your portable power station to a wall outlet with the AC charging cable, then press the button and connect your devices via the AC Outlet ports.

This product supports offgrid UPS. When you connect the grid power to the AC Input Port of the product through an AC cable, you can power electrical devices through an AC Output Port (AC power will come from the grid and not the portable power station in this situation). In case of a sudden blackout, the product can automatically switch to the inverter mode within 20ms. As an offgrid UPS, this function does not support 0ms switching. Please do not connect the product to any device that requires 0ms UPS, such as data servers and workstations. Please test and confirm compatibility before using the product as a UPS. We recommend that you only charge one device at a time and avoid using multiple devices simultaneously to avoid triggering overload protection. Yoshino assumes no responsibility for any device failures or data losses caused by misuse of this product.



Tech support based in the USA!

1 (800) 513-2797 [customersupport@YoshinoPower.com](mailto:customersupport@YoshinoPower.com)

Operating hours are 8:00 am - 4:30 pm PST (M-F).

## 7. Smart Link Technology – Expansion Battery

The B4000 SST can be connected with a Smart Expansion Battery (E2600 SST) to expand capacity to meet most any application via the battery expansion cable. Please refer to the user manual of E2600 SST Smart Expansion Battery for detailed instructions.

### **Expansion Battery, please follow the instructions below:**

1. Before connecting the portable power station to a Smart Expansion Battery, please make sure that both the product and the Smart Expansion Battery are turned off.
2. After connecting the portable power station to a Smart Expansion Battery, please make sure that both of their LCD screens display the smart link icon before using it.
3. Do not directly connect or disconnect the Smart Expansion Battery during charging or discharging processes.
4. Do not touch the metal pins of the Smart Expansion Battery port by your hands or other objects. Only clean using a soft dry towel if necessary.

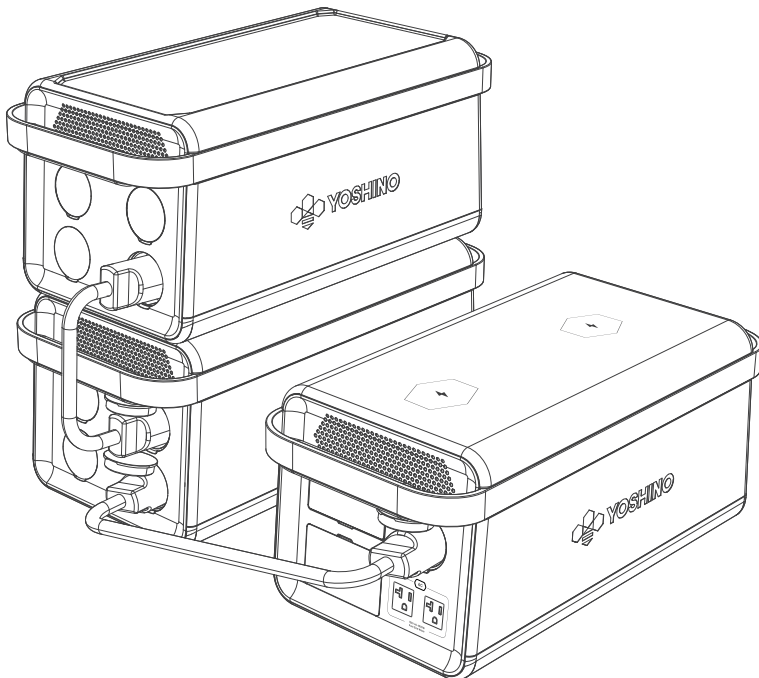

Tech support based in the USA!

1 (800) 513-2797 [customersupport@YoshinoPower.com](mailto:customersupport@YoshinoPower.com)

Operating hours are 8:00 am – 4:30 pm PST (M-F).

# 8. Specifications

## GENERAL



**Capacity**  
2611Wh  
48.36V, 54Ah



**Battery Type**  
Solid State  
Li-NCM 54Ah



**Cycle Life**  
2500 Cycles to  
80%+ Capacity



**AC Output (Rated)**  
4000W



**AC Output (Max)**  
6000W



**Warranty**  
5 Years



**Net Weight**  
53.6 lbs  
24.3 kg



**Dimension**  
21.4 x 10.2 x 9.4 inches  
543 x 260 x 240 mm

## INPUT



**AC Input**  
100-120VAC, 50/60Hz  
1800W Max



**Car Input**  
12VDC/10A,  
120W Max



**Solar Input**  
12-60VDC/10A Max  
600W Max

## OUTPUT



**AC Output**  
2 AC Outlets,  
120VAC/20A Max Each Port,  
TT-30R Outlet,  
120VAC/30A Max, 4000W Total



**12V DC Output**  
2 Ports,  
12.6VDC/10A,  
126W Total



**Wireless Charging**  
2 Ports, 5VDC/1A,  
9VDC/1.1A, 12VDC/1.25A,  
15W Max Each Port



**USB-A Output**  
2 Ports,  
5VDC/2.4A,  
20W Each Port



**USB-C Output**  
5VDC/3A, 9VDC/2.22A,  
12VDC/1.66A,  
20W Max



**USB-C PD Output**  
5-15VDC/3A,  
20VDC/5A,  
100W Max

## CERTIFICATIONS



**UN38.3**



## FEATURES

### APP



**BT / Wi-Fi**



**Smart Link**



**UPS**

## TEMPERATURE / HUMIDITY



**Discharging Temperature**  
14 to 104°F / -10 to 40°C



**Charging Temperature**  
32 to 104°F / 0 to 40°C



**Working Humidity**  
Maximum 90%



### PROTECTION

- Thermal Protection
- Short Circuit Protection
- Over Current Protection
- Over Voltage Protection
- Over Charging Protection
- Over Discharging Protection



Tech support based in the USA!

1 (800) 513-2797 [customersupport@YoshinoPower.com](mailto:customersupport@YoshinoPower.com)

Operating hours are 8:00 am - 4:30 pm PST (M-F).

## 9. Warranty

### Yoshino Return & Refund Policy

We are proud to have you join the Yoshino Solid-State Evolution and appreciate your support! Just in case things don't work out, our return policy is made simple and applies to those who purchased directly from our website, YoshinoPower.com within the USA.

**However, this policy applies only to purchases from our website;** for orders made outside of YoshinoPower.com, please contact your other merchant or retailer for further information about their return/refund policies. Note that our return/refund policy is subject to change based on local laws and regulations.

### Cancellation

All customers who made a purchase directly on YoshinoPower.com may request a full refund within 24 hours after placing that order; however, if you wait more than 24 hours before delivery, transaction fees will be applied depending on your payment method (3% for credit card users, 3.5% for PayPal users, etc.). Please note that orders cannot be canceled after being shipped out 30 days or fewer before such a request.

### Return

At Yoshino, we strive to ensure every customer has the best shopping experience. For that reason, customers in the USA can return any unused items for a full refund or exchange within 30 days of receiving their order. Furthermore, should there be an issue with purchased items – related to quality – our team will grant you a one-time free replacement within 30 working days from the delivery date. Please note that a Return Authorization Number (RAN) given to you by a Yoshino customer support team member is required for any return (see "Return Process" below). On returned US orders, there will be an additional charge for return shipping plus a transaction fee – 3% for credit card users, 3.5% for PayPal or Affirm customers, and 3.3% if Klarna is used as your payment method. If you decline your shipment, the original payment may still be subject to a double shipping fee.

### Return Process

Contact Yoshino Support via [customersupport@YoshinoPower.com](mailto:customersupport@YoshinoPower.com) to initiate the return process and provide you a Return Authorization Number (RAN). Please provide proof of purchase, such as a receipt or order confirmation. We will then provide instructions on properly packing the product(s) when returning them to us. Please ensure all original components are included in the package and have not been tampered with.

If you wish to return something that already has been shipped but not yet delivered, please first get in touch with our Support Team at [customersupport@YoshinoPower](mailto:customersupport@YoshinoPower) and follow their instructions!

### Refund

Yoshino will endeavor to process refunds within 14 business days after our receipt of the returned item. You will be notified when the order has been processed, and your funds are on their way back to you! If it's taking longer than expected, feel free to reach out through our customer support at [customersupport@YoshinoPower.com](mailto:customersupport@YoshinoPower.com) – we're here for you every step of the way!



Tech support based in the USA!

1 (800) 513-2797 [customersupport@YoshinoPower.com](mailto:customersupport@YoshinoPower.com)

Operating hours are 8:00 am – 4:30 pm PST (M-F).

## Limited Product Warranty

Yoshino Technology, Inc. proudly stands behind its products by offering a five (5) year limited warranty to the original consumer of any Yoshino product purchased directly from YoshinoPower.com or an authorized reseller in North America that any such Yoshino product will be free from defects in materials and workmanship, except for the exclusions listed below. The warranty period becomes effective from the date of delivery or pickup. Upon proper proof of purchase, Yoshino will replace or repair any product found to be defective within the applicable warranty period.

In order to obtain warranty service, please follow the procedures outlined in "Return Process" above. Yoshino will reimburse customers for the return shipping cost based on the original instructions provided by customer service for all items found to be defective. No return will be accepted without this Return Authorization Number (RAN).

Once the return has been received, a reply will be sent within 48 hours confirming receipt and updating the ticket status.

## Exclusions

Yoshino's warranty covers the product as long as it is used in its intended manner, and will not cover any of the following:

- Product that has been abused, misused, or otherwise not operated within the parameters of the literature provided with the product.
- Product with evidence of water damage or from use in bad weather (i.e., rain, dust/sandstorms.)
- Product that has been modified or had a repair attempted by anyone other than Yoshino.
- Any product not purchased directly from Yoshino or an authorized reseller such as auction sites or unauthorized online third-party sellers.

## Limitation of Liability

When receiving service, Yoshino Technology, Inc. is responsible for loss or damage to your product only when it is in Yoshino's possession. It is not responsible for any loss or damage that may occur in transit. Under no circumstances, and notwithstanding the failure of essential purpose of any remedy set forth herein, shall Yoshino, its affiliates, suppliers, resellers, or service providers be liable for any of the following even if informed of their possibility and regardless of whether the claim is based in warranty, negligence, strict liability or other theory of liability: 1) Third party claims against you for damages; 2) Special, incidental, punitive, indirect or consequential damages, including but not limited to lost profits, business revenue, goodwill or anticipated savings. In no case shall the total liability of Yoshino, its affiliates, suppliers, resellers, or service providers for damages from any cause exceed the amount of actual direct damages, not to exceed the amount paid for the product.

As some states or jurisdictions do not allow the exclusion or limitation of incidental or consequential damages, the above limitation or exclusion may not apply to you. This limited warranty gives you specific legal rights, and you may also have other rights which vary from jurisdiction to jurisdiction.

### **For any questions about the warranty, please contact customer service**

**Email:** [customersupport@YoshinoPower.com](mailto:customersupport@YoshinoPower.com)

**Phone:** +1 (800) 513-2797

Yoshino Technology, Inc. 18529 East Gale Avenue, City of Industry, CA 91748.









































Tech support based in the USA!

1 (800) 513-2797 [customersupport@YoshinoPower.com](mailto:customersupport@YoshinoPower.com)

Operating hours are 8:00 am - 4:30 pm PST (M-F).



# 10. Troubleshooting

Symbol	Problem	Solution
 AC  	Battery charging high temperature protection	Charging can be resumed automatically after the battery cools down.
 SOLAR  		
 AC  	Battery charging low temperature protection	Charging can be resumed automatically after battery temperature rises above 0°C (32°F).
 SOLAR  		
 AC 	AC/Solar/Car charging high temperature protection	After the product cools down, it will resume normal operation automatically.
 SOLAR 		
 AC Flashing  	Battery discharged high temperature protection	The product will shut down after warning. Discharging can be resumed automatically after the battery cools down.
 AC Flashing  	Battery discharged low temperature protection	The product will shut down after warning. Discharging can be resumed automatically after battery temperature rises above 0°C (32°F).
 AC Flashing 	AC/USB-C PD/DC output high temperature protection	After the product cools down, re-press the AC/USB/DC power button, it will resume normal operation automatically.
 USB-C PD Flashing 		
 DC Flashing 		
 USB Flashing	USB output overload protection	Remove the device connected to the USB-A port. Re-press the USB power button, it will resume normal operation automatically.
 AC Flashing  OVERLOAD	AC/USB-C/USB-C PD/DC output overload protection	Remove the overloaded device and re-press the AC/USB/DC power button, it will resume normal operation automatically. Electrical appliances should be used within rated power.
 QC Flashing  OVERLOAD		
 USB-C PD Flashing  OVERLOAD		
 DC Flashing  OVERLOAD		
	Battery Failure	If the prompt appears on the screen and does not disappear after restarting, stop using immediately and contact Yoshino customer service.

If the alarm prompt appears on the product LCD screen during use and remains on the screen after a restart, please stop using the product immediately. Please contact Yoshino Customer Service for further assistance.



Tech support based in the USA!

1 (800) 513-2797 [customersupport@YoshinoPower.com](mailto:customersupport@YoshinoPower.com)

Operating hours are 8:00 am - 4:30 pm PST (M-F).

## 11. FAQ

### 1. What battery does the product use?

The product uses a solid state Li-NCM 54A battery.

### 2. What devices can the product's AC output port power?

The portable power station's AC output ports can power most household appliances. Before connecting an appliance, confirm the power of the appliance to ensure that the sum power of all loaded appliances is lower than that of the rated power (4000W rated/6000W max).

### 3. Capacity

Multiply the capacity of the portable power station x 0.95 x 0.9 / device rated power. The 0.95 and 0.9 are DOD (depth of discharge) and inverter efficiency values. Let's use the B660 SST and a 60W CPAP machine as an example. The calculation would be 602Wh x 0.95 x 0.9 / 60W = 8.5 hours.

### 4. Can the B4000 SST charge and discharge at the same time?

Yes, the B4000 SST can charge and discharge at the same time. Please keep the equipment on a level surface during use, charging, and discharging.

### 5. Does the B4000 SST have cooling fan(s)?

Yes, the B4000 SST has fan(s) that will automatically activate to keep the unit from overheating.

### 6. How long can the product charge my devices?

Check the charging time shown on the product's LCD Screen. This can help you estimate the charging time of most appliances.

### 7. How do I know if the product is charging?

When the product is charging, the charging indicator icon begins to flash and the remaining time will be shown on the LCD screen.

### 8. How do I clean the product?

Use a soft dry towel to wipe gently across all surfaces.

### 9. How do I store the product?

If the portable power station is not going to be used for extended periods of time, power off the unit and disconnect the AC adapter from the outlet. Store product in a safe dry place with a temperature of 32-104°F / 0-40°C and a humidity within 90%. Every 3-6 months charge the product to 80% to protect battery life.



Tech support based in the USA!

1 (800) 513-2797 [customersupport@YoshinoPower.com](mailto:customersupport@YoshinoPower.com)

Operating hours are 8:00 am - 4:30 pm PST (M-F).

## 12. FCC Warning

This device complies with part 15 of the FCC Rules. Operation is subject to the following two conditions:

(1) This device may not cause harmful interference, and (2) this device must accept any interference received, including interference that may cause undesired operation.

Any changes or modifications not expressly approved by the party responsible for compliance could void the user's warranty to operate the equipment.

Note: This equipment has been tested and found to comply with the limits for a Class B digital device, pursuant to part 15 of the FCC Rules. These limits are designed to provide reasonable protection against harmful interference in a residential installation. This equipment generates uses and can radiate radio frequency energy and, if not installed and used in accordance with the instructions, may cause harmful interference to radio communications. However, there is no guarantee that interference will not occur in a particular installation. If this equipment does cause harmful interference to radio or television reception, which can be determined by turning the equipment off and on, the user is encouraged to try to correct the interference by one or more of the following measures:

- Reorient or relocate the receiving antenna.
- Increase the separation between the equipment and receiver.
- Connect the equipment into an outlet on a circuit different from that to which the receiver is connected.
- Consult the dealer or an experienced radio/TV technician for help.

This equipment complies with FCC radiation exposure limits set forth for an uncontrolled environment. This equipment should be installed and operated with minimum distance 20cm between the radiator and your body.



Tech support based in the USA!

1 (800) 513-2797 [customersupport@yoshinopower.com](mailto:customersupport@yoshinopower.com)

Operating hours are 8:00 am - 4:30 pm PST (M-F).

For FAQs and more information, please Visit:

**YoshinoPower.com**

## **Yoshino Technology Inc.**



**Tech support based in the USA!**

**1 (800) 513-2797**

**customersupport@YoshinoPower.com**

**Operating hours are 8:00 am – 4:30 pm PST (M-F).**

 18529 East Gale Avenue, City of Industry, CA 91748

 [www.YoshinoPower.com](http://www.YoshinoPower.com)