

For FAQs and more information, please Visit:

YoshinoPower.com

Yoshino Technology Inc.



Tech support based in the USA!

1 (800) 513-2797

customersupport@YoshinoPower.com

Operating hours are 8:00 am - 4:30 pm PST (M-F).

18529 East Gale Avenue, City of Industry, CA 91748

www.YoshinoPower.com



QUICK START GUIDE

B2000 SST

Solid-State Portable Power Station

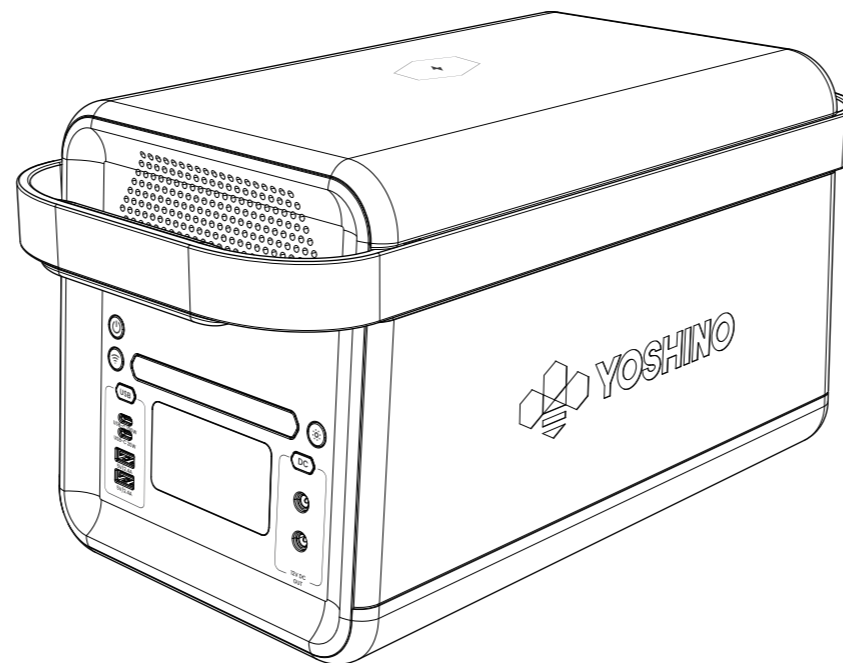

Yoshino APP

You can use the Yoshino app to monitor, control or customize your portable power station. Download at <https://YoshinoPower.com>

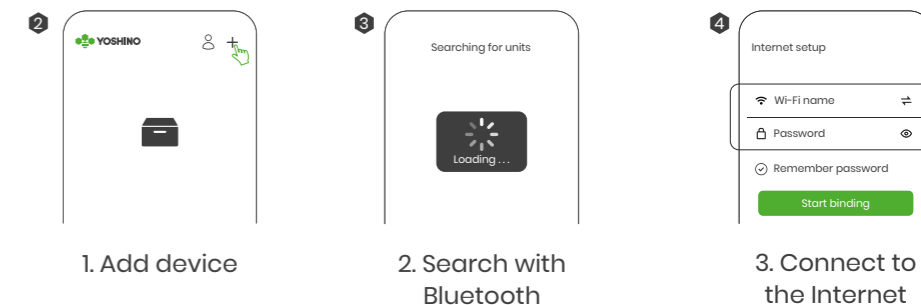
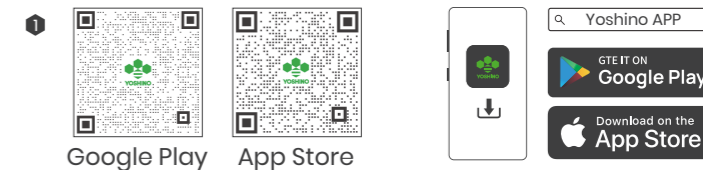

What's in the Box

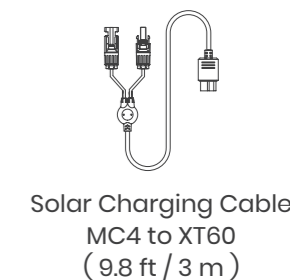
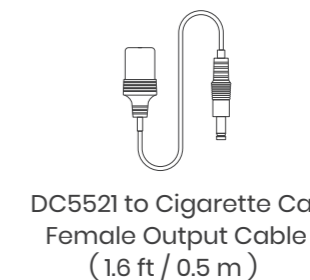
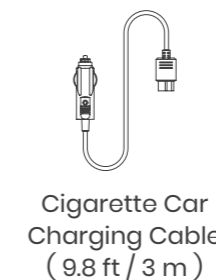
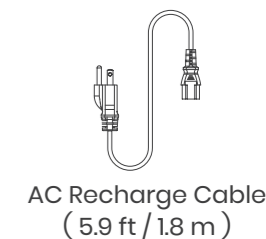
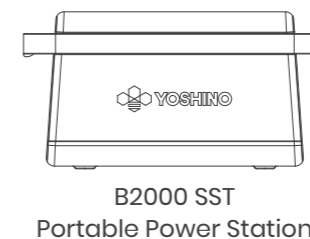

1. Your First Power Up

1.1 AC Charging

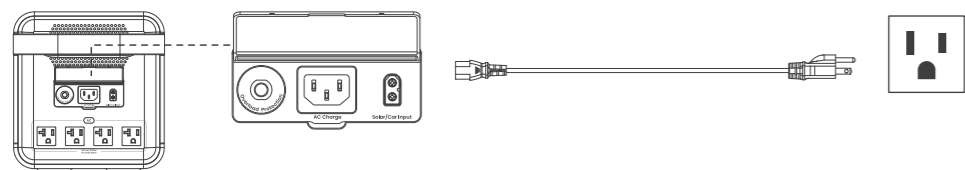

1500W AC can charge to 80% capacity in approximately 45 minutes

1.2 Car Charging

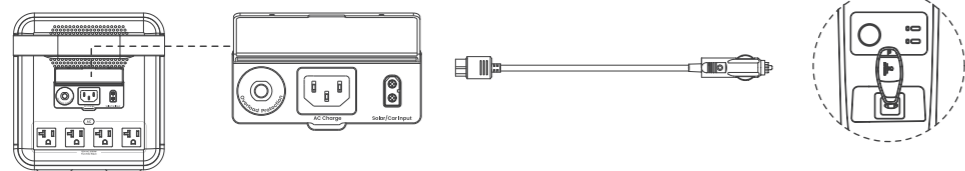

120W Car Charging can charge to 80% capacity in approximately 9 Hrs.

1.3 Solar Charging

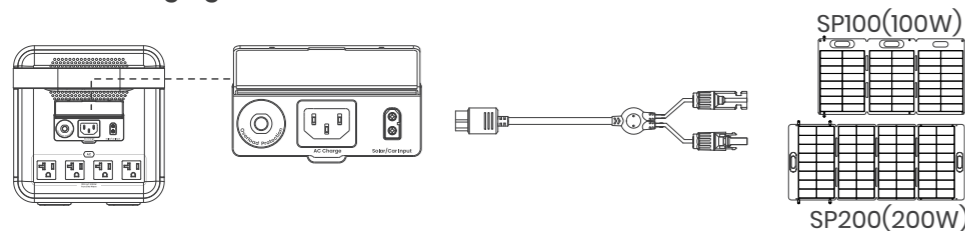

SP100(100W) or 200W(200W) Solar Charging can charge to 80% capacity in approximately 2.5 Hrs (Using 3 SP200 Solar Panels).

2. Operation

2.1 Power Button

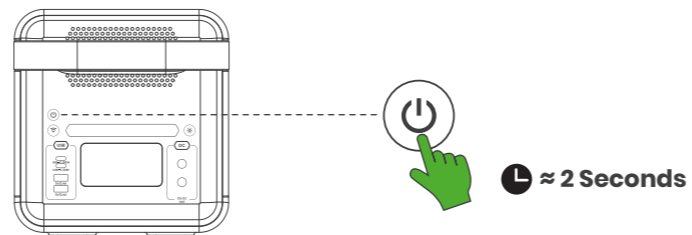

⌚ ≈ 2 Seconds

Press and hold the main power button for 2 seconds to turn on the product. The LCD screen will light up and the main power indicator will turn pulse white. Press and hold the main power button again for 2 seconds to turn the device off. The word "OFF" will appear on the screen, then the power indicator light and LCD screen will turn off.

2.2 App Connectivity

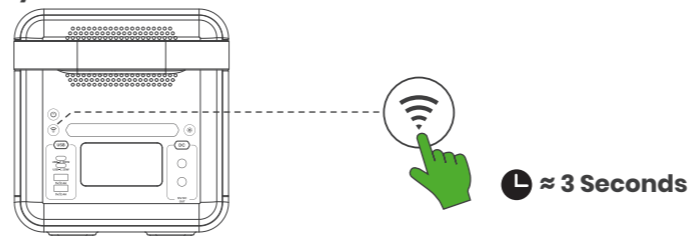

⌚ ≈ 3 Seconds

Press and hold the app connection button for 3 seconds until you hear a beep, then the icon will flash until it connects successfully. If the app fails to connect, the icon will go off.

2.3 LED Light

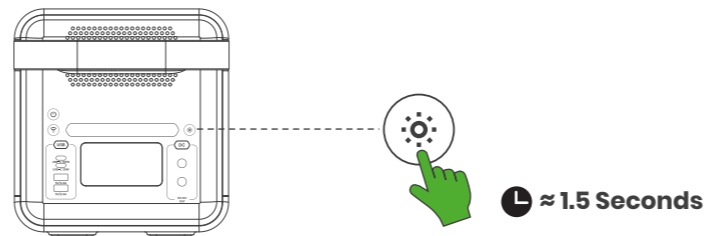

⌚ ≈ 1.5 Seconds

Press and hold the LED Light Button for 1.5 seconds until the LED light turns on. Press and hold the button for 1.5 seconds again to turn the LED light off.

2.4 AC Output

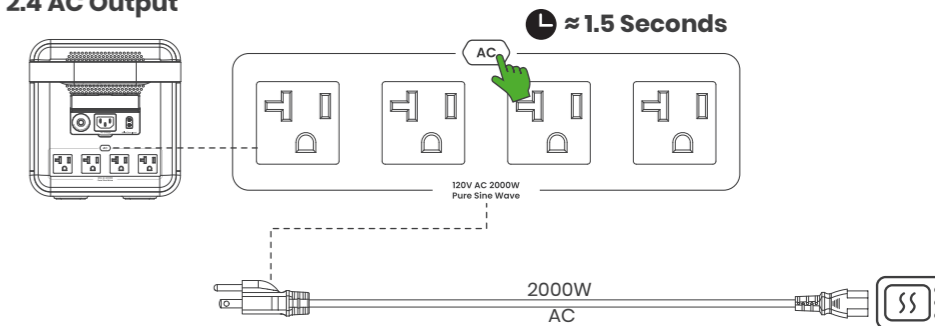

⌚ ≈ 1.5 Seconds

Press and hold the AC Power Button for 1.5 seconds until the button lights. Press and hold the button for 1.5 seconds again to turn off power to the AC outlets.

2.5 USB Output

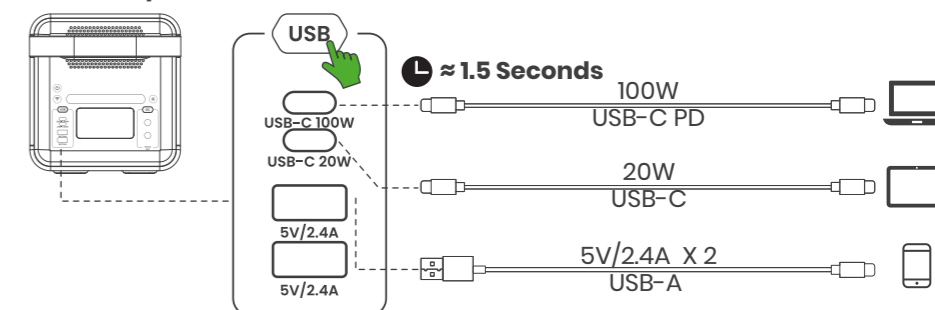

⌚ ≈ 1.5 Seconds

Press and hold the USB button for 1.5 seconds until the button lights. Press and hold the button for 1.5 seconds again to turn power off to the USB ports.

2.6 DC Output

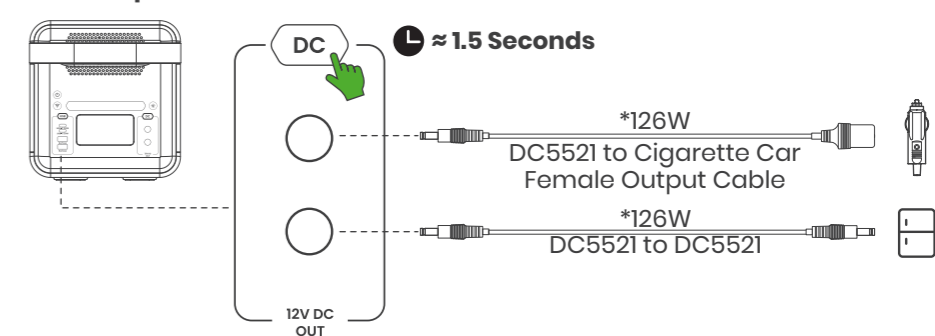

⌚ ≈ 1.5 Seconds

Press and hold the DC power button for 1.5 seconds until the button lights. Press and hold the button for 1.5 seconds again to turn power off to the DC ports.
***Output power total is 126W**