

THE HENSLEY
ARROW™ AND CUB™
INSTALLATION and
OPERATION MANUAL

IMPORTANT: KEEP THIS MANUAL IN THE TRAILER.

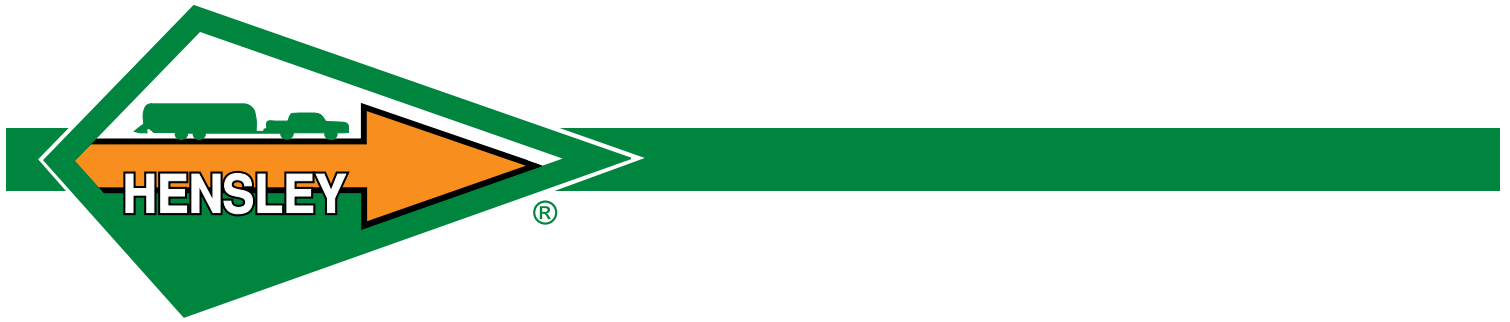

TOW SAFE LLC

151 Shafer Drive • Romeo, Michigan 48065

810-658-0006 • 1-800-410-6580

Welcome to the Family of Hensley Arrow™ and Cub™ Owners,

Thank you for purchasing the Hensley Arrow™ or Cub™ towing system. These systems have been engineered to make your towing experience the most pleasurable possible.

Since the Hensley Arrow™ and Cub™ are intended to be a lifetime investment, we encourage you to become thoroughly familiar with this Installation and Operation Manual. It is designed to provide you with the information you will need to successfully maintain and operate your new towing system. If you do encounter a problem the manual does not cover, we are only a telephone call away.

Please follow the written instruction when installing your Hensley Arrow™ or Cub™. If you have any questions, give us a call at 1-800-410-6580.

Sincerely,
TOW SAFE LLC
DBA HENSLEY MFG
James Morrison
PRESIDENT

STOP MAIL IN YOUR WARRANTY TODAY

WARNING: RETURN OF WARRANTY REGISTRATION IS A CONDITION PRECEDENT TO WARRANTY COVERAGE. IF THE FORM IS NOT RECEIVED COMPLETED AS DIRECTED WITHIN 180 DAYS, YOU WILL NOT HAVE A WARRANTY.



HENSLEY WARRANTY REGISTRATION

Please read the following information carefully. After you have read the notice, please sign your name on the space provided.

WARNING

The Hensley Arrow™ towing system attaches to the trailer tongue. It is rated for a maximum tongue weight of 1,400 lbs and gross weight of the trailer (including the load) of 14,000 lbs. The Hensley Cub™ towing system attaches to the trailer tongue. It is rated for a maximum tongue weight of 600 lbs. and gross weight of the trailer (including the load) of 6000 lbs. The towing vehicle and the vehicle hitch that is the connecting mechanism that includes the ball platform and other components that extend and attach to the towing vehicle, are both separately rated for maximum tongue weight and gross weight of the trailer (including the load).

Refer to the manufacturer of your vehicle and your vehicle hitch for the maximum tongue weight and gross weight of your towing vehicle and vehicle hitch.

Do not exceed the maximum of your towing vehicle, your vehicle hitch or the Hensley Arrow™ towing system.

I have read the above warning and understand its content.

Date: _____

Signature: _____

To activate your lifetime warranty, please read and fill out the following information and return this card to:

TOW SAFE LLC, 151 Shafer Drive, Romeo, MI 48065

Please print the following information 🖨

Serial # _____

Serial # is on the nameplate on the main unit.

Purchased From: _____

Name: _____

Address _____

City _____ State _____ Zip _____

Hme PH: _____ Wrk PH: _____

HENSLEY HITCH BAR ORDER FORM

Please Print the following information and send your order to :
TOW SAFE LLC, 151 Shafer Drive, Romeo, MI 48065
 or call 1-800-410-6580

NAME: _____ PH: _____

ADDRESS _____

CITY _____ STATE _____ ZIP _____

VISA/MASTERCARD _____

EXPIRATION DATE: _____

TOW _____ TRAILER _____

VEHICLE: _____ (i.e. 1/2T SUB, 3/4T PU, Car etc..) (i.e. Jayco, AWARD, Airstream)

The following measurements will help us to determine which hitch bar to ship to you.

To measure for the hitch bar, your tow vehicle and trailer need to be on a level surface.

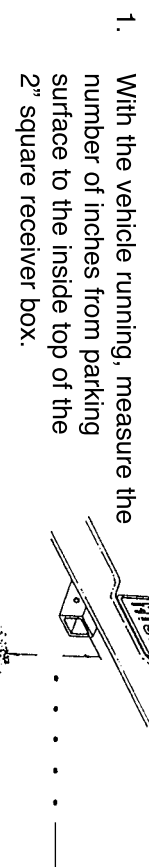

2. Circle the letter for which type of coupler is on your trailer.

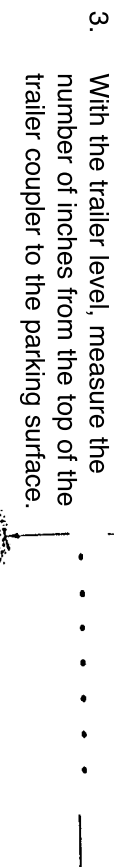

NOTE: The top of the ball of the Hensley Arrow® is approximately 5 1/2" above the top of the hitch bar.

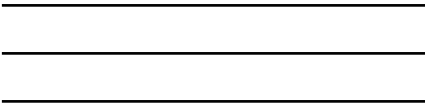

NO POSTAGE
NECESSARY
IF MAILED
IN THE
UNITED STATES

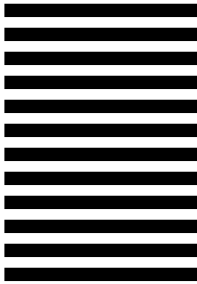

BUSINESS REPLY MAIL
FIRST CLASS MAIL PERMIT NO 14 DAVISON MI

POSTAGE WILL BE PAID BY ADDRESSEE

HENSLEY MFG., INC.
151 Shafer Drive
Romeo MI 48065

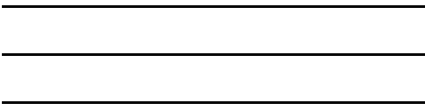

NO POSTAGE
NECESSARY
IF MAILED
IN THE
UNITED STATES

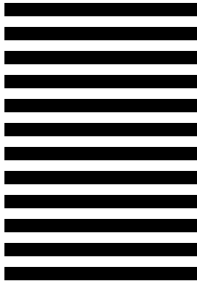

BUSINESS REPLY MAIL
FIRST CLASS MAIL PERMIT NO 14 DAVISON MI

POSTAGE WILL BE PAID BY ADDRESSEE

HENSLEY MFG., INC.
151 Shafer Drive
Romeo MI 48065



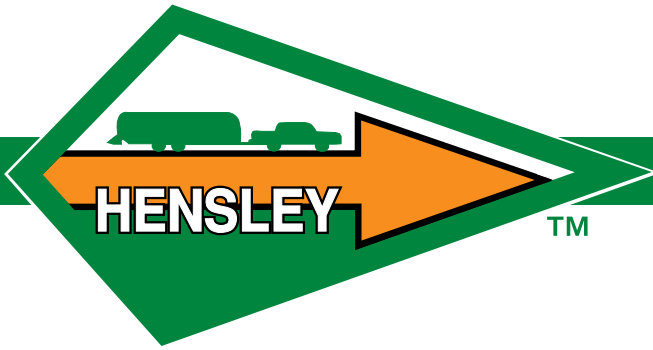

GUARANTEES 2

LIFETIME WARRANTY 3

PARTS LIST 5-7

INSTALLATION INSTRUCTIONS 8-9

INSTALLATION OF FRAME BRACKETS 10-11

INSTALLATION OF JACKS 12-13

INSTALLATION OF SWIFT LIFT KIT 14

INSTALLATION OF SPRING BARS 15-16

INSTALLATION OF STRUT ASSEMBLIES 17

STRUT ADJUSTMENT 18

TENSIONING OF SPRING BARS 19-20

HOOK-UP PROCEDURES 21-25

INSTALLATION AND SAFETY CHECKLIST 26

UNHOOKING PROCEDURES 27

QUICK REFERENCE HOOKING & UNHOOKING 28-29

MORE HITCH HINTS 30

MAINTENANCE 31

INSPECTION 32

HITCH BAR EXCHANGE CLUB 33

FREQUENTLY ASKED QUESTIONS 34-35

GUARANTEES



60 DAY MONEY BACK GUARANTEE

With your purchase of the Hensley Arrow™ or Cub™, you receive a 60 day unconditional money back guarantee.

If, for any reason, you are not completely satisfied with your Hensley Arrow™ or Cub™, you may return it for a full refund.

HENSLEY GUARANTEES YOUR SATISFACTION

As a Hensley Arrow™ or Cub™ owner, you have become a part of our extended family. It is important to us that you receive prompt, courteous assistance with your Hensley Arrow™ or Cub™.

Tow Safe LLC leads the hitch industry in quality, innovation, reliability and performance.

Our 60 day unconditional money back guarantee demonstrates our commitment to you. We stand behind our products' quality and YOU.

This means that every step of the way, from your first telephone call, through purchase and delivery, to after-sales service, we're committed to the spirit as well as the letter of our guarantee.

This is the Hensley way of doing business. It's as simple as a smile, a handshake, and a promise kept.

RETURNS: 60 DAY MONEY BACK GUARANTEE

- In order to process your return, please call 800-410-6580 and speak with your salesman.
- Reimbursement for the cost of the hitch will be issued 7-10 business days after the hitch, including all original components, has been received by Tow Safe LLC. Shipping is the responsibility of the customer.
- Hitch must be back in the possession of Tow Safe LLC within 60 days of purchase date or guaranteed start date for refund.
- Any modifications done to the hitch or its components may void refund.

LIFETIME WARRANTY

THE HENSLEY LIFETIME LIMITED WARRANTY

As an original owner of the Hensley Arrow™ or Cub™ advanced towing system, you receive a lifetime limited warranty on all parts and service.

What Is Covered

The Lifetime Limited Warranty period begins upon receipt of signed Hensley Arrow™ or Cub™ warranty registration card.

The Lifetime Warranty is limited to the original purchaser of the Hensley Arrow™ or Cub™ advanced towing system. The Lifetime Warranty is non-transferrable.

This warranty covers repair or replacement to any Hensley Arrow™ or Cub™ part (not manufactured by others) that is defective in materials or workmanship under normal use.

Warranty items should be returned to Tow Safe LLC for inspection. (See page 31 for shipping address.)

Customer is responsible for all freight charges associated with warranty work.

What is Not Covered

- A) Items added or changed after the unit left the possession of Tow Safe LLC.
- B) Any use of the Hensley Arrow™ or Cub™ for rental or other commercial purposes.
- C) Normal wear and usage, such as fading or discoloration of painted parts.
- D) Minor imperfections which do not affect the suitability of the Hensley Arrow™ or Cub™ for its intended use.
- E) Costs incurred as the result of the consumer's request to have repairs performed, or replacement of parts supplied by other than Tow Safe LLC without proper notification or authorization by Tow Safe LLC.
- F) This warranty does not apply to or cover any component which has its own warranty by its manufacturer.
- G) Costs incurred as a result of improper dealer installation.

Note: This product, like your tow vehicle, requires proper care and maintenance. Failure to provide the proper care and maintenance, or to observe the proper handling and use of the Hensley Arrow™ or Cub™, will result in damage to the product. Instructions regarding care and maintenance and proper usage of the Hensley Arrow™ or Cub™ are contained in the Owner's Manual and Supplement Manuals which accompany this product.

It is important that if a defect is noted, the owner notifies Tow Safe LLC and complies with the instructions for correction of the defect. Failure to notify Tow Safe LLC or to comply with corrections given about damage to the hitch, may cause further damage that is not covered under this warranty.

LIFETIME WARRANTY

**THIS LIMITED WARRANTY GIVES YOU SPECIFIC LEGAL RIGHTS,
AND YOU MAY ALSO HAVE OTHER RIGHTS WHICH VARY FROM STATE TO STATE**

NOTICE:

EXCEEDING MAXIMUM CAPACITY CREATES A SAFETY HAZARD

ARROW: 14,000 lb. max - Gross Trailer Weight Rating

1,400 lb. max - Tongue Weight Rating

CUB: 6,000 lb. max - Gross Trailer Weight Rating

600 lb. max - Tongue Weight Rating

The Hensley Arrow™ towing system attaches to the trailer tongue. It is rated for a maximum tongue weight of 1,400 lbs. and gross weight of the trailer (including the load) of 14,000 lbs.

The Hensley Cub™ towing system attaches to the trailer tongue. It is rated for a maximum tongue weight of 600 lbs. and gross weight of the trailer (including the load) of 6,000 lbs.

The towing vehicle, and the vehicle hitch receiver, that is the connecting mechanism which includes the ball platform and other components that extend and attach to the towing vehicle are both separately rated for maximum tongue weight and gross weight of the trailer (including the load).

Refer to the manufacturer of your vehicle and your vehicle hitch receiver for the maximum tongue weight and gross weight of your towing vehicle and vehicle hitch receiver.

Do not exceed the maximum of your towing vehicle, your vehicle hitch receiver or the Hensley Arrow™ or Cub™ towing system.

PARTS LIST: SWIFT LIFT KIT

- 1** SWIFT LIFT HANDLE
- 2** SWIFT LIFT (snap-up style) FRAME BRACKETS
- 3** SWIFT LIFT SUPPORT CHAINS
- 4** SPRING BAR SUPPORT RODS

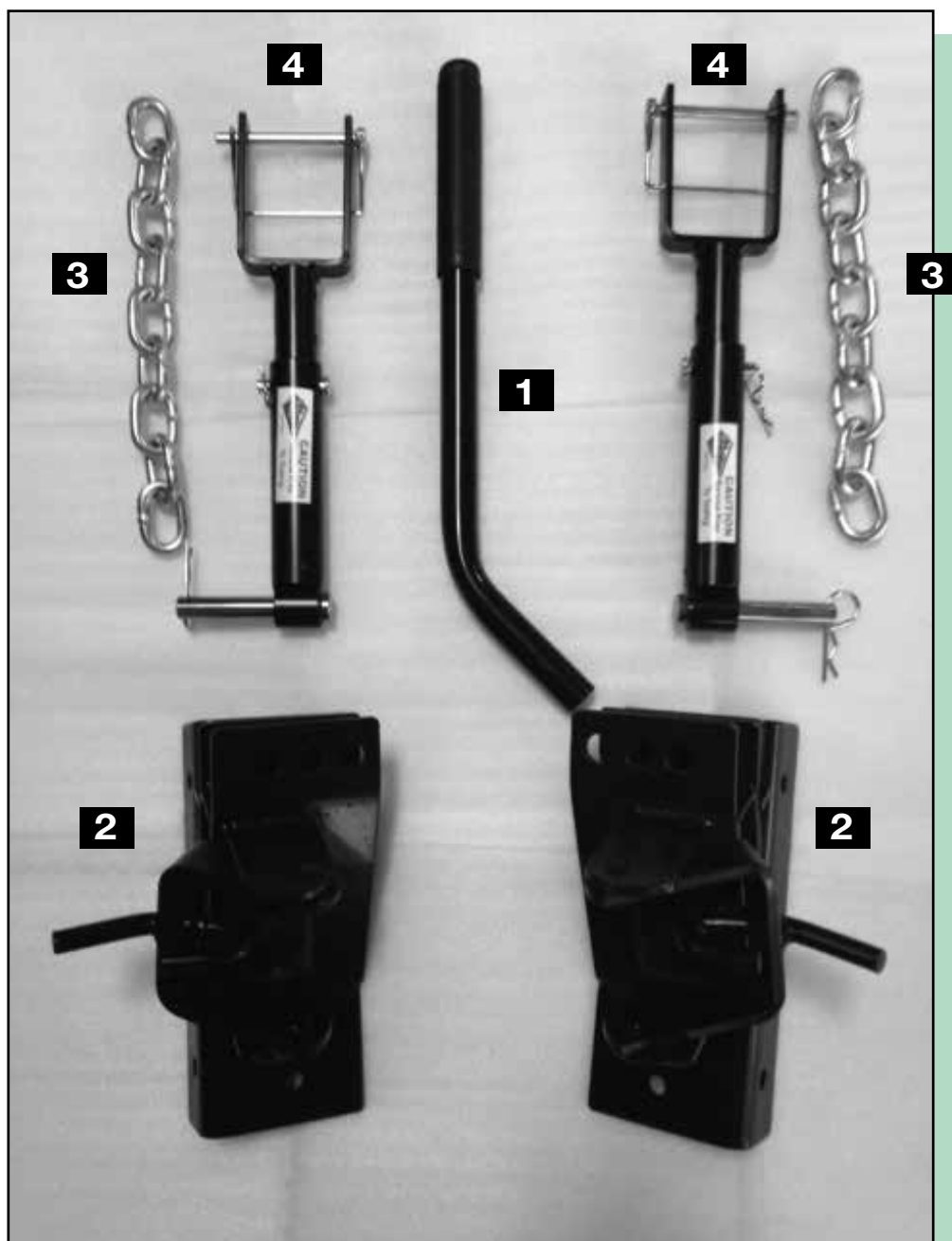

PARTS LIST: STANDARD AND I/C JACK KITS

- 1 MAIN HITCH ASSEMBLY
- 2 OCL (Over Center Latch)
- 3 HITCH BOX
- 4 OCL ADJUSTABLE SCREWS
- 5 HITCH BAR
- 6 SAFETY KEYS
- 7 HITCH BAR PIN & SAFETY CLIP
- 8 OCL WRENCH
- 9 JACK ASSEMBLY (Adjustable)
- 10 SPRING BARS
- 11 STRUT ASSEMBLY
- 12 FRAME BRACKET
- 13 SPRING BAR U-BRACKET
- 14 U-BOLTS (Frame Bracket)
- 15 U-BOLTS PLATES
- 16 HITCH BALL
- 17 RATCHET WRENCH
- 18 DRILL BIT (5/16")
- 19 SELF-TAPPING SHEAR BOLTS

REQUIRED TOOLS

TORQUE WRENCH
11/16" DEEPWELL SOCKET
3/16" ALLEN WRENCH
SCREW DRIVER OR CRESENT WRENCH
TAPE MEASURE
DRILL MOTOR
GREASE GUN
MULTI-PURPOSE BEARING GREASE

TORQUE CONVERSION CHART

45ft lbs.	=	61 Newton Meters
	=	540 inch lbs
	=	6.2 meters kilograms

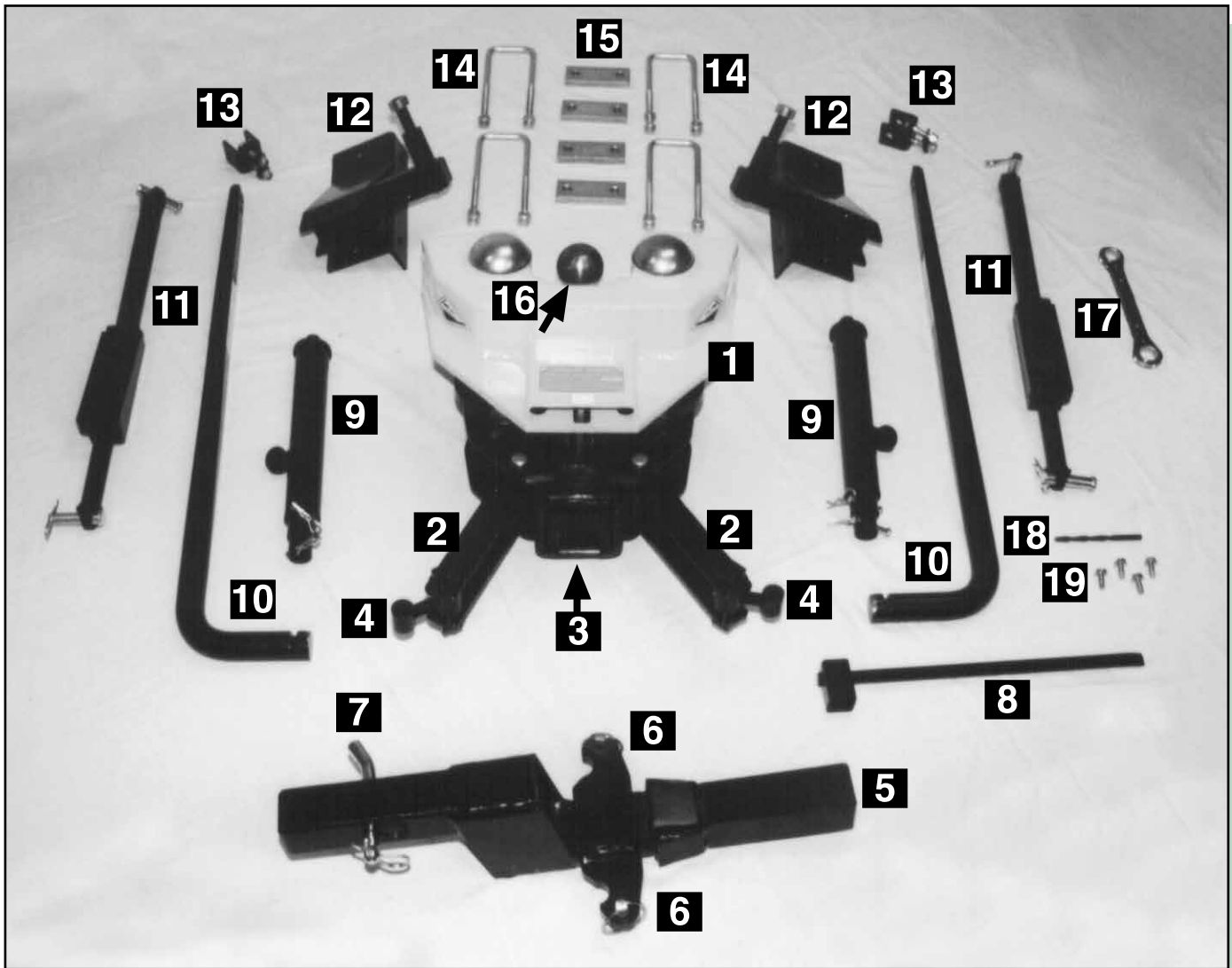

Complete normal hook-up of safety chains, electric plug, and breakaway switch cable. In some cases these will have to be lengthened due to the Hensley Arrow™ and Cub's™ extra length which increases the distance between the trailer and the tow vehicle approximately 12 inches.

INSTALLATION INSTRUCTIONS

- 1** Be sure the tow vehicle and trailer are on level ground and in line with each other before starting installation.
- 2** Insert the hitch bar into the hitch receiver of the tow vehicle. Secure the hitch bar with the hitch pin and clip.

ALWAYS Secure the hitch bar with pin and clip upon installation

- 3** At the front of the main hitch assembly, rotate the Over-Center-Latch (OCL) assemblies outward and backward toward the main hitch assembly. (see figure 1-13)
- 4** Lift up the main hitch assembly and slide the hitch box over the end of the hitch bar.
- 5** Rotate the Over-Center-Latches (OCL) forward over the tabs of the hitch bar. Using the OCL wrench on an OCL lug (top or bottom), rotate the adjustable screw into the notch on the hitch bar tab, and the

OCL links will contact the sides of the hitch box. (This is the built-in stop.)

- 6** Insert safety keys into the holes in the tabs on the hitch bar.

HITCH HINT:

If an OCL turns in with very little force, unlatch it and swing it back out. Lengthen the adjustment screw by turning the screw out, 1/2 turn at a time until it latches firmly. When properly adjusted, it takes some force (like a pair of vice-grip pliers) to get the latch firmly seated in its latched position.

If an OCL is too hard to turn in, do not force the latch into its latched position. Shorten the adjustment screw by turning the screw in 1/2 turn at a time until it latches firmly. When properly adjusted, it takes some force (like a pair of vice-grip pliers) to get the latch firmly seated in its latched position.

NOTE:

When properly adjusted, it will only take a small amount of force (like a pair of vice-grip pliers) to get the latch firmly seated in a locked position. It may be necessary, however, to adjust the OCL's from time to time as the wedged surfaces seat themselves against each other.

IMPORTANT:

Once installation is complete, be sure to review pg. 26 - Installation and Safety Checklist

INSTALLATION INSTRUCTIONS cont.

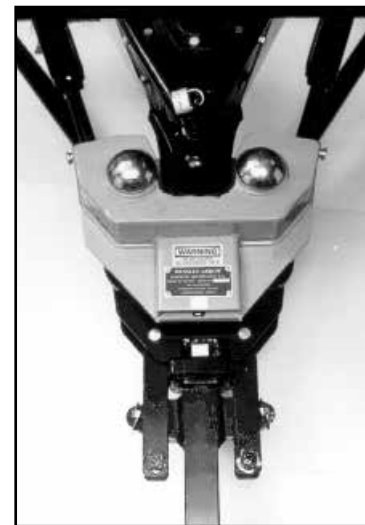
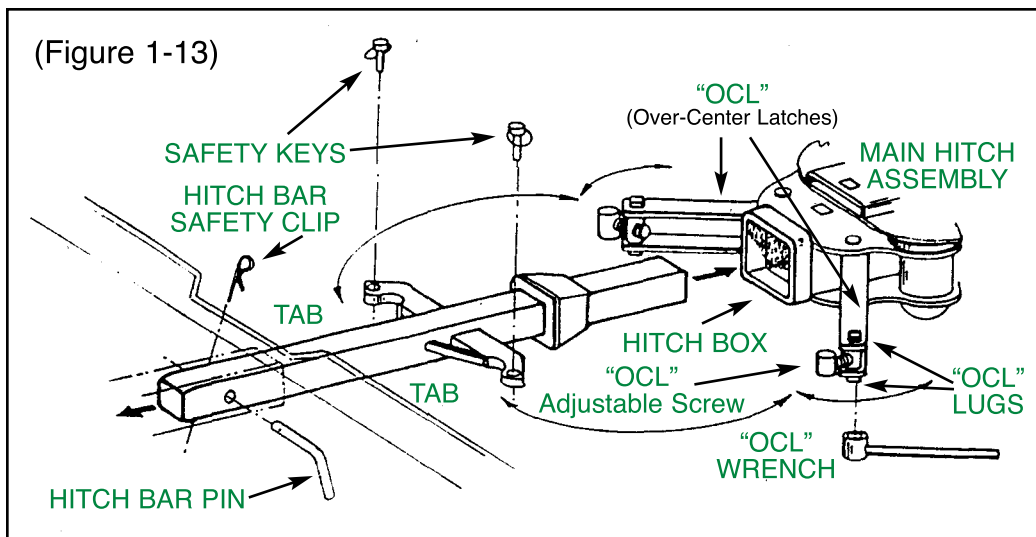

(INSTALLATION cont...)

- 7 Center the hitch assembly so that the white squares on the front (lower) and rear (upper) members are aligned. (This is for installation purposes only. White squares may be removed after installation.)
- 8 Grease the ball liberally.
- 9 Back the tow vehicle until the ball is under the coupler.
- 10 Lower coupler on to the ball and latch into place, allowing the tongue jack to continue supporting the weight of the trailer.

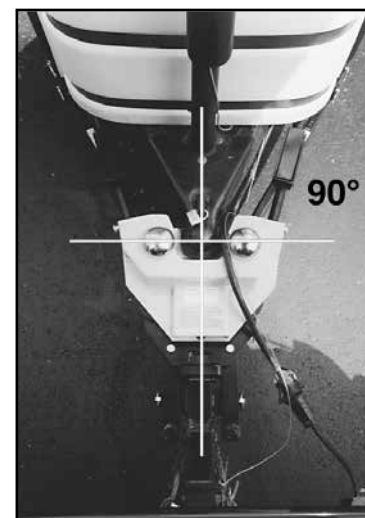

NOTE:

Some trailers equipped with the "C" type coupler (see Fig. 1-19, pg. 16) may not latch down properly because the flange on the coupler will not allow it to fit over the ball. To accommodate for this you will need to unlatch the OCL's and slide the main unit off the hitchbar and manually lift the main unit and ball at an "angle" into the coupler. Be sure to latch the coupler lock so the main unit will not fall to the ground. The locking mechanism will support its weight. The main unit is heavy so you may need a 2nd person to do the lifting while the other locks the coupler onto the ball. You do not necessarily need to hook the vehicle back up to finish installation.

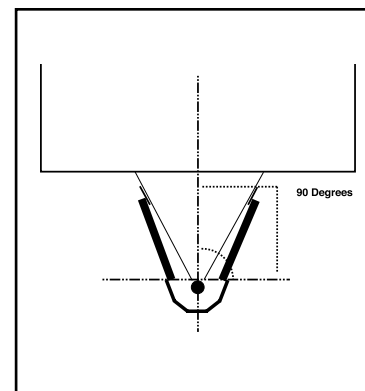

IMPORTANT:

Put the transmission in park and set the parking brake before finishing the installation.

INSTALLATION OF FRAME BRACKETS (ALL STYLES)

INSTALLATION OF FRAME BRACKETS

- 1 On the trailers A-frame, measure 25 1/2" (+/- 1/2") back from the center of the ball and mark this point on the trailer A-frame.

NOTE:

This measurement should be only +/- 1/2".

- 2 Seat the frame bracket on the trailer A-frame with the front edge of the bracket at the 25 1/2" mark on the trailer frame.

NOTE:

When installed correctly, the holes of the frame bracket are forward.(see fig.# 2-15)

If you are installing standard frame brackets on a trailer with an A-frame that is only 3" tall you will need to use the 1" spacers supplied so you can tighten the u-bolts down. Put the spacers on the bottom of the A-frame.

If you are installing the inverted frame brackets for the type C coupler (see fig #1-19 page 16) and your Aframe is only 5" tall you will need to use the spacers supplied so you can tighten the u-bolts down. Put the spacers on the top of the A-frame.

FOR STANDARD C-CHANNEL FRAMES ONLY: Drill (4) 7/16 diameter holes through the pre-drilled holes in the frame brackets and into the trailer A-frame. Attach the brackets using 3/8" diameter bolts, nuts and washers.

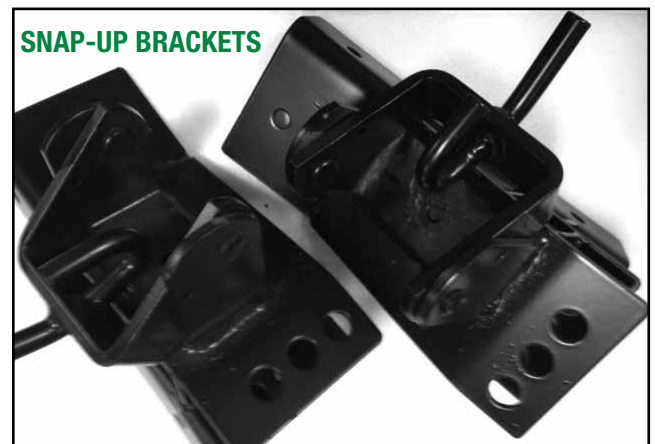
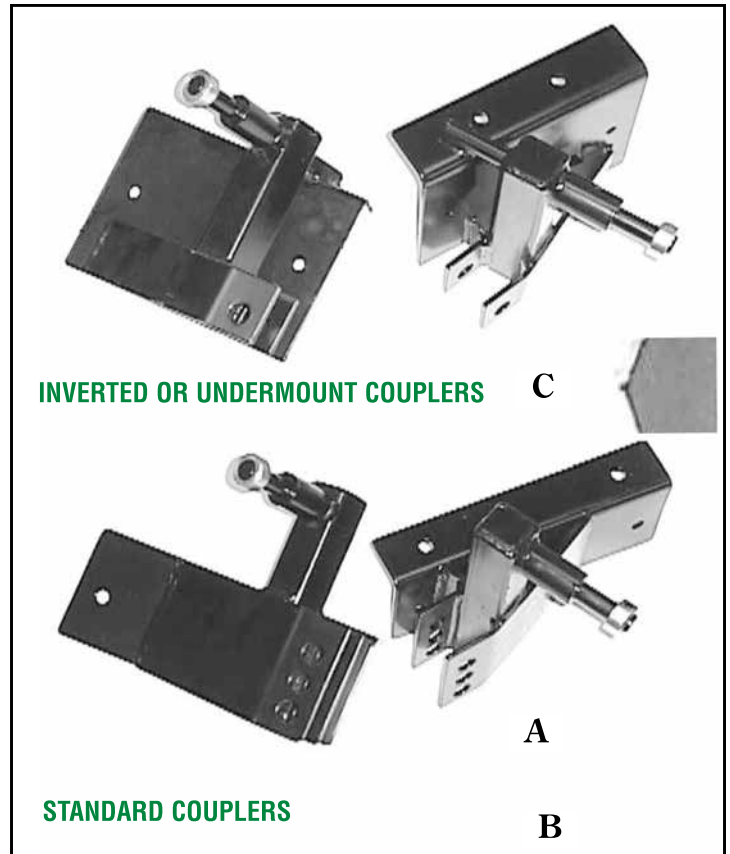

INSTALLATION OF FRAME BRACKETS cont.

3 Clamp the frame brackets to the A-frame with the U-bolts (threaded end down). Place one U-bolt on the frame bracket in front of the strut bracket spacer and one U-bolt on the rear of the frame bracket inside the angle of the strut support. (Or the closest position to these depending on the position of other attachments to the tongue.)

4 Slide one U-bolt plate over the bottom end of each U-bolt and secure them with the lock washers and U-bolt nuts. Tighten to 45 ft. lbs.

Note: Re-torque the U-bolt nuts regularly starting within the first 200 miles.

IMPORTANT
Use a torque wrench to tighten to 45 ft.lbs.

(Torque conversion chart on page 7.)

5 Using the enclosed 5/16" drill bit and any two of the four pre-drilled holes in the frame bracket as a guide, drill two holes in the trailer frame and install a self-tapping shear bolt into each hole. To insure proper threading, apply pressure squarely into the hole during tapping.

DO NOT OVER TIGHTEN.

6 Repeat this procedure with the other frame bracket.

Note: There are only 2 Shear bolts per bracket

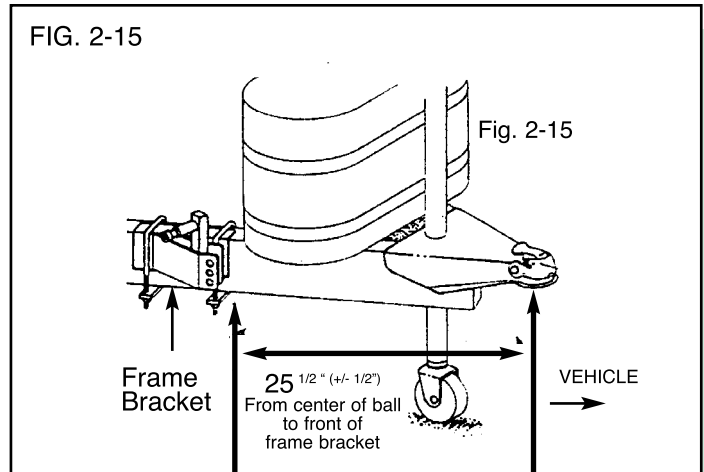

CAUTION

In some cases, damage to the struts can occur if :

- Frame brackets are not properly located 25 1/2" back from center of ball.
- U-bolts are not torqued to 45 ft. lbs. or equivalent. (See conversion chart on page 7).
- Shear bolts are not in place.

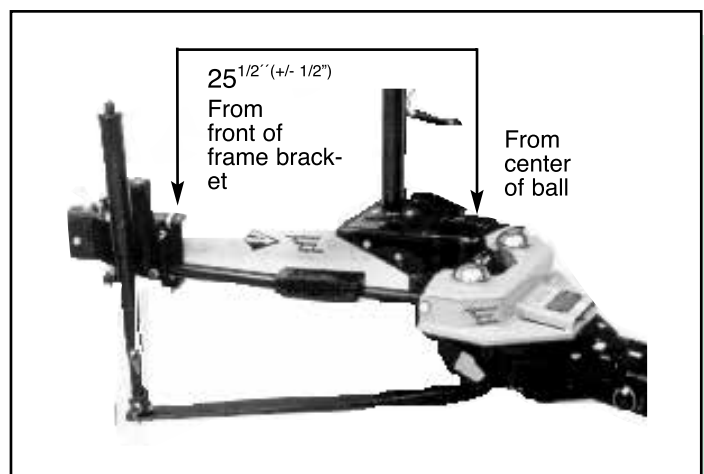

INSTALLATION OF JACKS

*IF INSTALLING SWIFT LIFT KIT, SKIP TO PAGE 14

- 1 Remove locking collar from the mounting pin on the frame bracket and lubricate the mounting pin with grease. (see fig. 1-17, pg. 13)
- 2 Fully extend the jack by turning the hex nut at the top counter clockwise. If the bottom of the barrel turns with the unit, simply hold the bottom stationary and the jack will extend. Be sure to fully extend the jacks until they stop.
- 3 Mount the jack on the frame bracket by sliding it over the mounting pin as shown in the Figure 1-17. When mounted correctly, the barrel of both jacks will be on the forward side of the mounting pin (toward the tow vehicle) as Figure 2-17 shows.
- 4 Secure the jack to the mounting bracket by replacing the locking collar and tightening the set screw into the recess on the mounting pin with an Allen wrench (3/16"). The recess is normally located on the top of the mounting pin.
Note: Check the set screw for tightness regularly.
- 5 Repeat for other side.

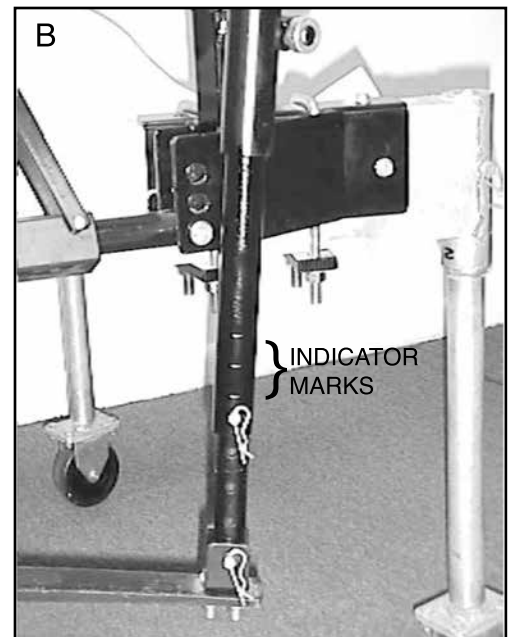
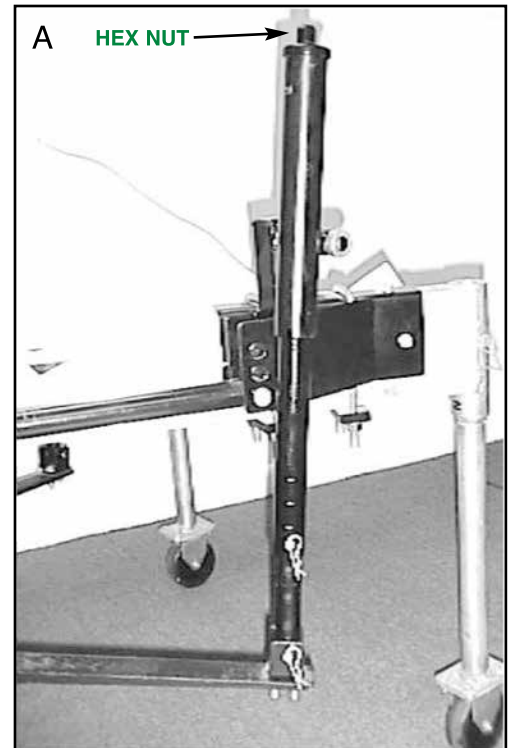

INSTALLATION OF JACKS cont.

Fig. 1-17

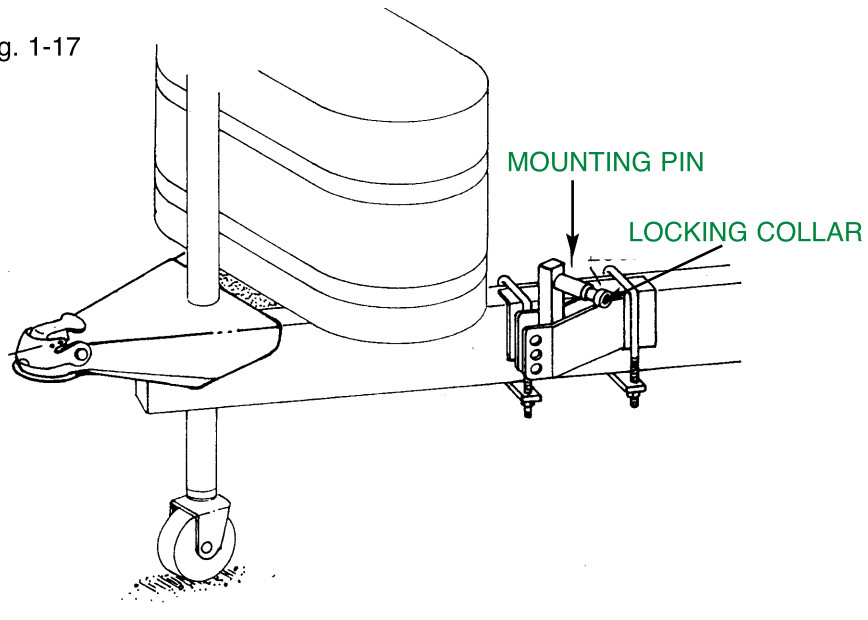

MAIN HITCH ASSEMBLY

STRUT ASSEMBLY

INDICATOR MARKS JACK ASSEMBLY

SPRING BAR BUSHING

SPRING BAR LINK

SPRING BARS

U-BRACKET

SPRING BAR ELBOW

Fig. 2-17

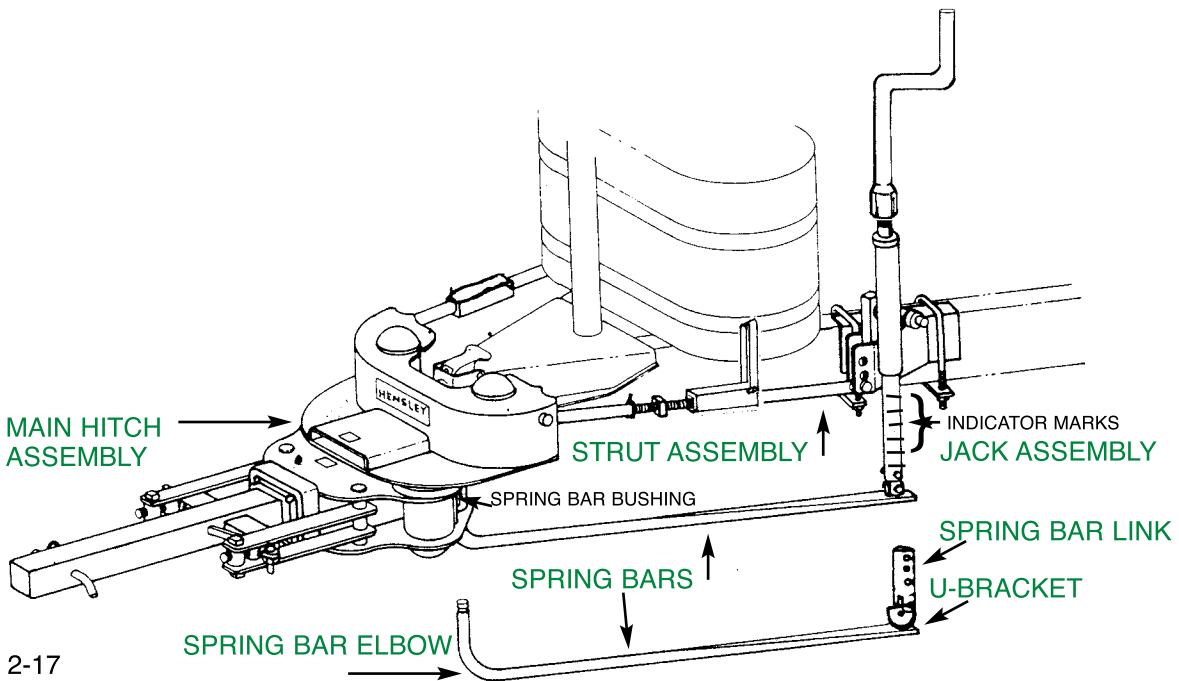

* FREQUENTLY ASKED QUESTIONS CAN BE FOUND ON PAGE 34-35

INSTALLING THE SWIFT LIFT KIT

- 1** Install the frame brackets for the SwiftArrow™ or SwiftCub™ exactly the same as you would the original Arrow™ or Cub™.
- 2** Use the 4” long gold colored pin and clip to attach the spring bar support rods to the frame bracket. There are 3 sets of holes on the front of the frame bracket for you to attach the spring bar support rods and the strut bars. Pin the support rods to the bottom set of holes on the frame brackets. Put the gold colored pin through the support rod first, then insert it through the frame bracket and secure it in place on the inside of the bracket with the clip. This will leave the support rod attached on the outside of the frame bracket.
- 3** Attach the chain links to the spring bar u-brackets using the 2.5” long silver pins and clips.

Continue following the manual with the installation of the spring bars and the strut assemblies. As the manual mentions, you need to install the strut bars in whichever set of holes on the frame bracket that will hold the strut bars most parallel to the top of your trailer A-frame. With most trailers the strut bar will be most parallel to the A-frame when the strut is attached to the frame bracket in the top or center set of holes. If it is necessary to pin the strut bar in the bottom set of holes, unclip and remove the long gold pin and support rod. Re-insert the gold pin back in place first through the support rod, then through the outside hold of the frame bracket, then through the strut bar and secure it all in place on the inside of the bracket with the clip. This will leave the support rod on the outside of the frame bracket and the strut between the flanges of the bracket using only the one gold pin to hold both components to the frame bracket.



INSTALLATION OF SPRING BARS

Locate the zerks on the lower unit of the main hitch assembly (picture C). The zerk is fitted into the end of a threaded bushing which also houses a spring loaded retainer pin on the opposite side of the zerk (See Fig. 1-18). The pin should snap into the Spring Bar Groove when the bar is inserted into position in the lower unit. (Zerk fitting is preset at factory although some adjustment may be needed.) If adjustment is necessary, loosen the adjustment locknut then adjust threaded bushing into or out of lower unit as necessary to position the retainer pin correctly. Do not screw threaded bushing too far into lower unit as damage to retainer pin can occur when towing. Re-tighten locknut to secure.

Application:

Liberal grease the round end of the spring bar by hand using bearing grease from your grease gun. Avoid dropping the bar as small pebbles and dirt will stick to the grease. With the spring bar extending back toward the trailer, insert the round end of the bar into the lower unit housing and align the approximate center of the groove with the grease zerk. To lock in, exert upward pressure with one hand under the elbow of the bar while flexing the opposite end up and down. You may or may not hear the clicking sound of the retainer pin snapping into the groove. Try applying some downward pressure on the bar to see if it has locked in. If the bar falls out, you may need to adjust the retainer pin in increments of 1/2 turn at a time and retry. Do not screw the threaded bushing too far into the hole as damage can occur to the retainer pin when towing. Finally connect the lower jack pin to the spring bar U-Bracket to secure. Repeat these steps for the 2nd bar. **If your Hensley Arrow™ is equipped with the heavy duty 1400# spring bars and you need to disconnect the spring bars for storage or service work, to avoid damaging the retainer pin, you will need to unscrew the small zerk fitting off the threaded bushing and then rotate the spring bar forward toward the vehicle until the bar drops out of the housing. Then re-screw the zerk back onto the bushing tightly. If you have the 600# or 1000# spring bars you do not have to unscrew the zerk. Simply disconnect the jack pin from the spring bar and rotate bar toward vehicle.**

Assembly

- 1 Grease the grooved end of the spring bar housing liberally by hand.
- 2 Insert the grooved end of the spring bar into the housing until the bar is held into position by the spring loaded retainer pin.

NOTE:

Insert the round end of the spring bar into a spring bar bushing. Grasp the elbow of the spring bar using upward pressure, while moving the opposite end of the spring bar up and down until the spring bar snaps into place.

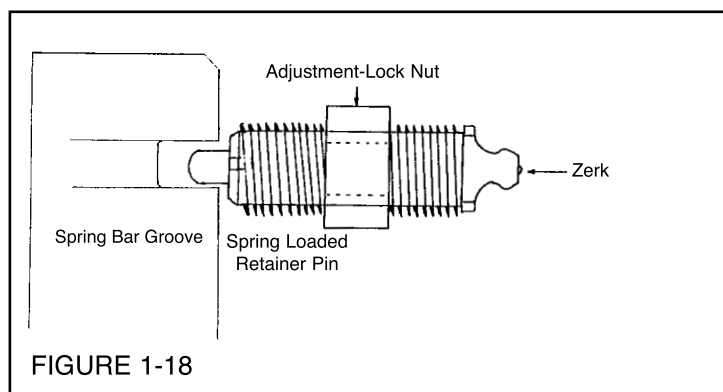
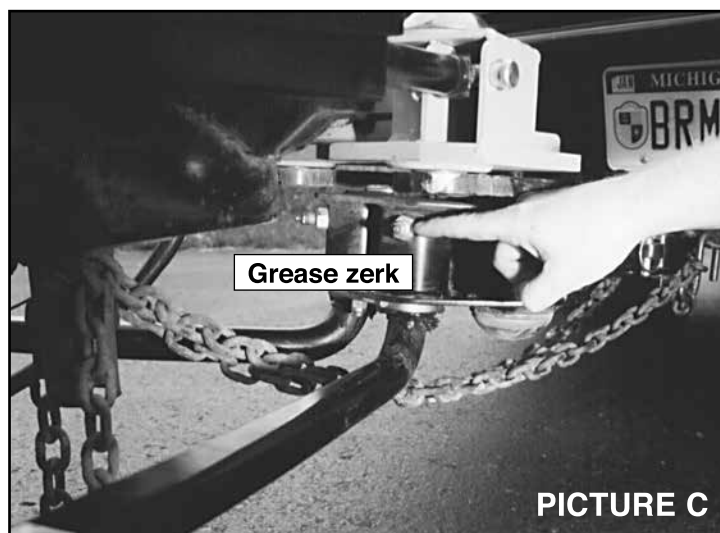

INSTALLATION OF SPRING BARS cont.

- 3 Attach the end of the spring bar to the bottom of the jacks.
 - A. Turn the bottom of the Jack so that the three height indicator marks are facing out and visible.
 - B. Attach the spring bar to the bottom of the jack using the pins and clips provided. Insert the pin from the back side, and pin from the front by pushing it all the way through to the round portion of the pin.
- 4 Set the spring bar links using the coupler style chart as a starting point. (Example: If you have coupler style A, put the pin in the fifth hole up from the bottom of the link. The first hole is used to attach the link to the spring bar, there will be three empty holes and the link will be pinned in the fifth hole.) If this setting will not allow your jacks to be adjusted such that they will hold the hitch head horizontal with the ground, the spring bar links can be adjusted as needed. (See 1-19 for starting position suggestions.
- 5 Repeat this procedure with the other spring bar.
- 6 Using a grease gun, apply grease through the grease zerks until you see it come out the bottom of housing.

SUGGESTED STARTING POSITIONS

(Can vary with different vehicle/trailer combinations)



If you have coupler A you'll have 3 holes showing on the spring bar link.

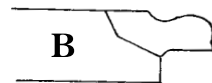

If you have coupler B you'll have 2 holes showing on the spring bar link.



If you have coupler C you'll have 3 holes showing on the spring bar link.

Fig.1-19

HITCH HINT:

On the jack barrel, be sure the three height indicator marks are facing away from the trailer A-frame for future reference. (Fig. 2-19)

Fig. 2-19

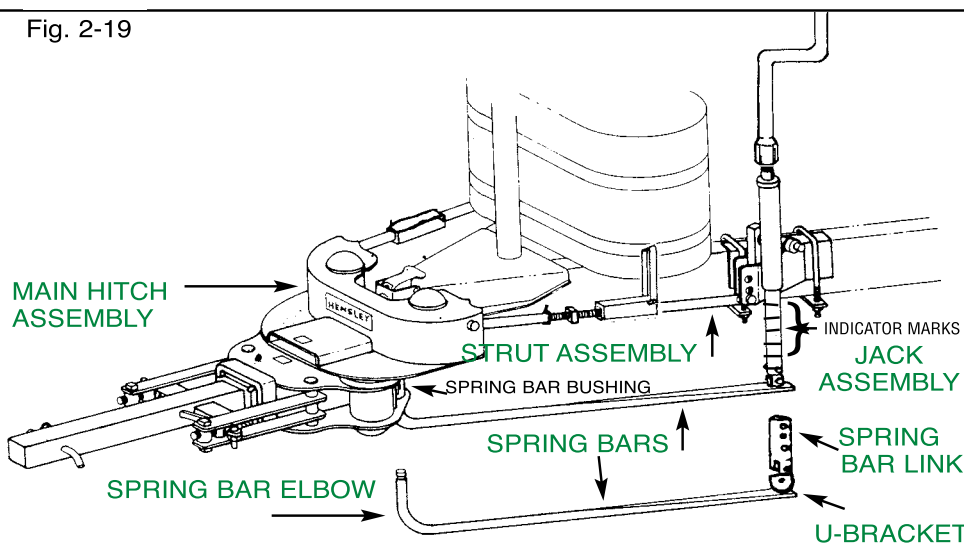

IMPORTANT: Be sure both the spring bar links are installed at the same height (i.e. same number of holes are showing on both sides.)

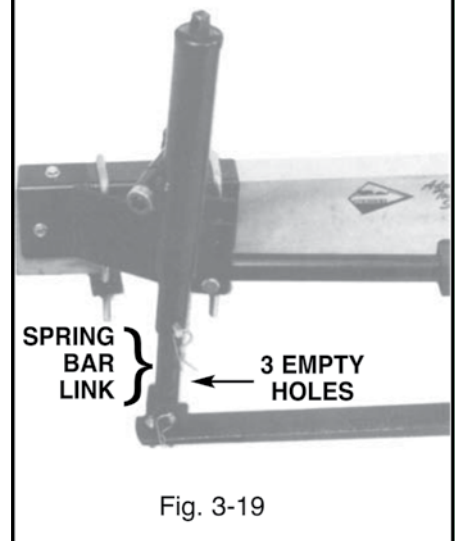

Fig. 3-19

INSTALLATION OF STRUT ASSEMBLIES

IMPORTANT FOR PROPER HITCH PERFORMANCE

The struts are one of the most important components of the Hensley Arrow™ or Cub™. Failing to install or adjust them properly may impede the systems performance. Please read the instructions carefully.

- 1** Raise the handle and slide the locking sleeve back to reveal the square strut nut. Adjust the nut toward the locking sleeve post as far as the threading will allow.
- 2** Secure the strut between the main hitch assembly and the frame bracket using the 5/8" x 2 1/2" pins and clips provided. When properly installed, the locking sleeve post will be closer to the main hitch assembly and will be in the up position as shown in the diagram. (2-21)

Repeat steps with the other strut assembly.

- 3** (a) If your frame bracket has more than one hole available, select the one which positions the strut closest to parallel with the top of the trailer A-frame.

(b) The 5/8" x 2 1/2" pins should be inserted from the outside-in so that the retaining clip is inserted on the back side, closest to the A-frame. Push the retaining clip all the way through to the round portion. You may elect to replace the retainer clips provided with more permanent cotter keys (not provided) after you are certain all the components have been inserted and adjusted correctly. (See figure A. pg. 12).

(c) If the handle of the locking sleeve does not reach far enough to fit down over the locking sleeve post when the sleeve has been advanced into position, the handle may need to be turned back in the other direction. Observe the position of the rivet in the diagram.

The struts are now installed but not adjusted. Disconnect vehicle from Hensley Arrow™ or Cub™ and adjust struts. (Continue to page 18 to complete strut adjustments.)

NOTE:
Level struts are important for proper handling.

IMPORTANT

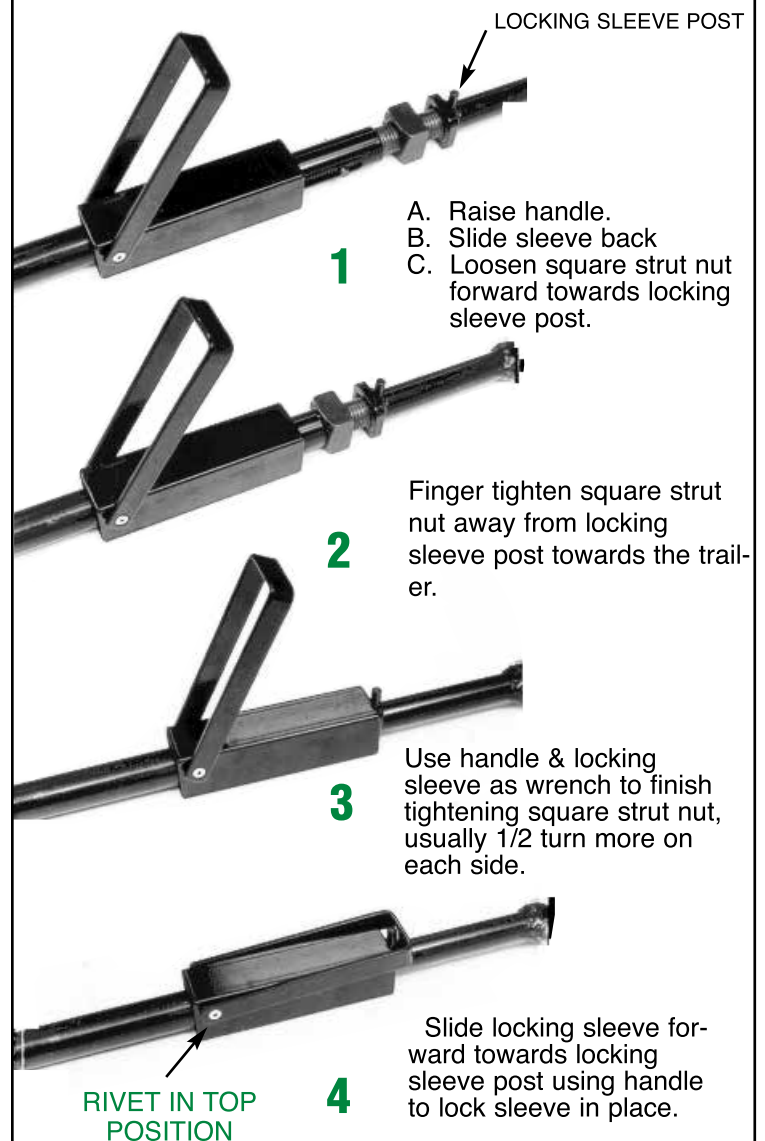

HENSLEY ARROW™ STRUT ADJUSTMENT

IMPORTANT FOR PROPER HITCH PERFORMANCE

The major function of the struts is to hold the Upper Unit (the orange section with the ball mount on it) “square” in relationship to the trailer. When both struts are tight, they will not allow either the Upper Unit or the trailer to pivot from side to side on the ball. (Struts will not move when shaken. They should feel like a solid bar.) Be sure to check them at each hookup.

The struts are correctly adjusted when the Upper Unit is held firmly in a position perpendicular to the centerline of the trailer as shown. It doesn't have to be absolutely perfect! (For all you perfectionist types.) You can take measurements if you want, but most people will be able to line it up sufficiently just by looking at the unit in relationship to the A-frame. Strut adjustment is not difficult or mysterious. Make sure the Upper Unit is in this position, the struts are tight. You should check for tightness every time you hookup.

NOTE: The length of the strut will depend on placement of the Frame Bracket. For example, if the right bracket is 1/2” further back on the A-frame than the left bracket, the right strut will be longer than the left one in order to hold the Upper Unit “square” with the trailer. Also, many other factors could account for “long and short” struts.

Application: IT IS EXTREMELY IMPORTANT THAT YOU ADJUST YOUR STRUT BARS PROPERLY IN ORDER TO COMPLETELY ELIMINATE TRAILER SWAY. When tightening the struts, you are actually pushing the hitch away from the trailer. Facing the trailer, turn the large square nut on both struts clockwise with the top of the nut turning to your right. This adjustment will move the large square nut towards the trailer and away from the locking post. Be sure both struts are approximately the same length and the orange part of the hitch is fairly square with the body of the trailer. Tighten both square nuts as tight as you can get them by hand. Then use the locking sleeve as a wrench and turn each nut another 1/4 to 1/3 turn beyond hand tight. Grab each strut where it pins to the orange part of the hitch and try to move them back and forth side to side. The struts need to be firm and not slide back and forth on the pins that hold them to the orange part of the hitch. If they still move on the pins you need to turn the large square nut clockwise another 1/4 turn at a time until they are firm and do not move on the pins. **DO NOT OVER TIGHTEN THE STRUTS.** Do not put all your weight on the locking sleeve to try to turn it one last 1/4 turn. If it takes too much effort you should back the nut back off to the previous 1/4 turn so you can close the locking sleeve over the locking sleeve post.

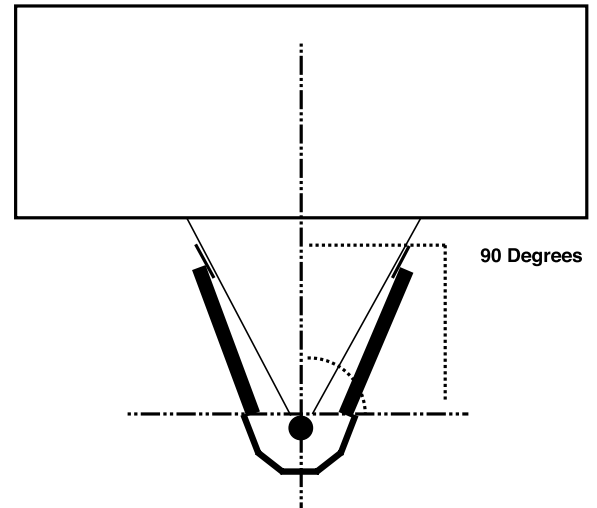

IMPORTANT! CHECK YOUR STRUTS EVERY TIME YOU HOOK UP TO MAKE SURE THEY ARE FIRM!

STRUT ASSEMBLY

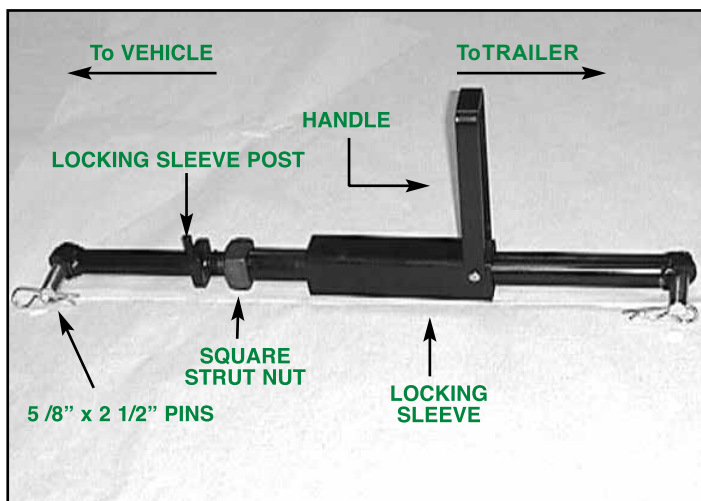

FIG. 1-21

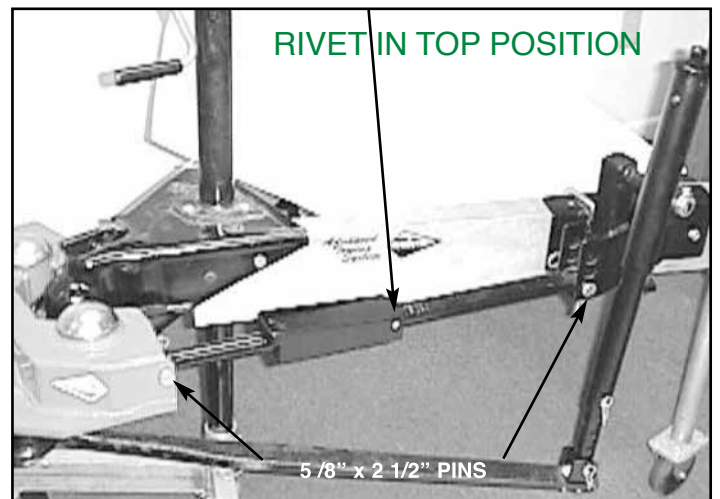

FIG. 2-21

TENSIONING SPRING BARS WITH STD. JACK KIT

***IF YOU HAVE THE SWIFT LIFT KIT, SEE PAGE 25**

The amount of tension adjustment on the spring bars varies with the trailer/vehicle combination, load distribution within the trailer and whether you prefer a stiff or soft ride.

Your vehicle and travel trailer may not be perfectly level, even with the Hensley Arrow™ weight distributing qualities. This is due to differences in the trailer/vehicle combinations and load distribution within the trailer.

The height indicator marks on the outside of the jack barrel are designed as a gauge. Start by adjusting to the same height indicator mark on the outside of the jack barrel at the start of each trip. This is just a starting point. We recommend to put them on the middle mark to begin.

If at any time the jacks loosen during your travels, add more tension at each gas up. Never oil or lubricate the internal mechanism of the jacks.

Adjustments to the jack tensioning system can be made at any time during your travels.

If the ride feels too soft or too stiff, the spring bars can be tensioned or un-tensioned to make your ride more comfortable.

Tensioning the spring bars can be done by using the ratchet wrench (provided), BAL hand crank, socket ratchet or drill with socket.

- ☞ Turn to the right to raise the spring bar which adds tension, and stiffens the ride.
- ☞ Turn to the left to lower the spring bar, which releases tension, and softens the ride.

WARNING

EXCEEDING MAXIMUM CAPACITY CREATES A SAFETY HAZARD

The Hensley Arrow™ system attaches to the trailer tongue. It is rated for a maximum tongue weight of 1,400 lbs. and gross weight of the trailer of 14,000 lbs. (including the load).

The towing vehicle, and the vehicle hitch receiver, that is the connecting mechanism that includes the ball platform and other components that extend and attach to the towing vehicle, are both separately rated for maximum tongue weight and gross weight of the trailer (including the load).

Refer to the manufacturer of your vehicle and your vehicle hitch receiver for the maximum tongue weight and gross weight of your towing vehicle and vehicle hitch receiver.

Do not exceed the maximum of your towing vehicle, your vehicle hitch receiver or the Hensley Arrow™ towing system.

*** SPRING BARS CAN HANDLE THE MAXIMUM TENSION THAT THE JACKS WILL ALLOW**

TENSIONING SPRING BARS cont.

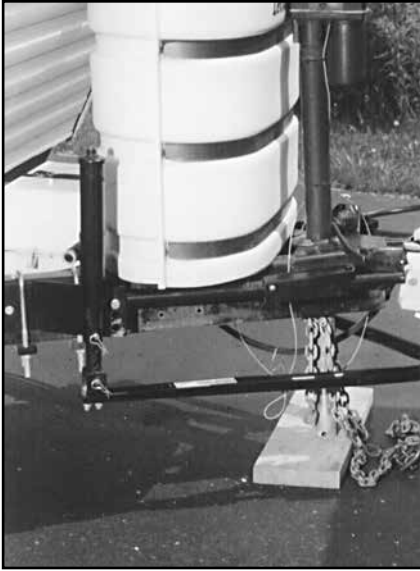

Tension the spring bars by using the ratchet wrench.

Turn the ratchet wrench *clockwise* to raise the spring bar, which *adds* tension.

Turn the ratchet wrench *counter clockwise* to lower the spring bar, which *releases* tension.

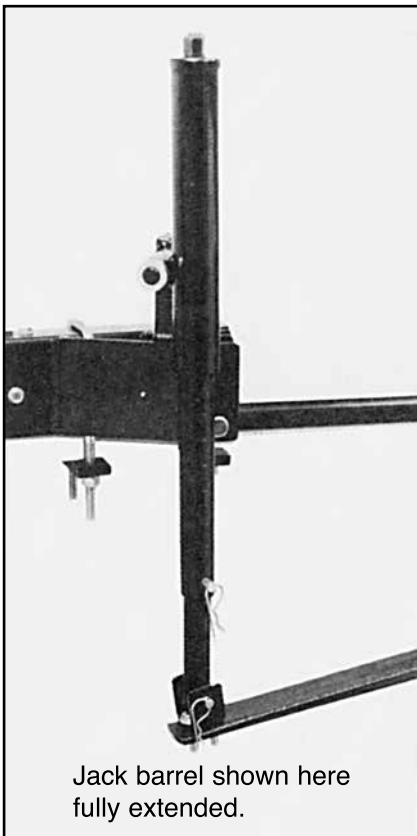

Jack barrel shown here fully extended.

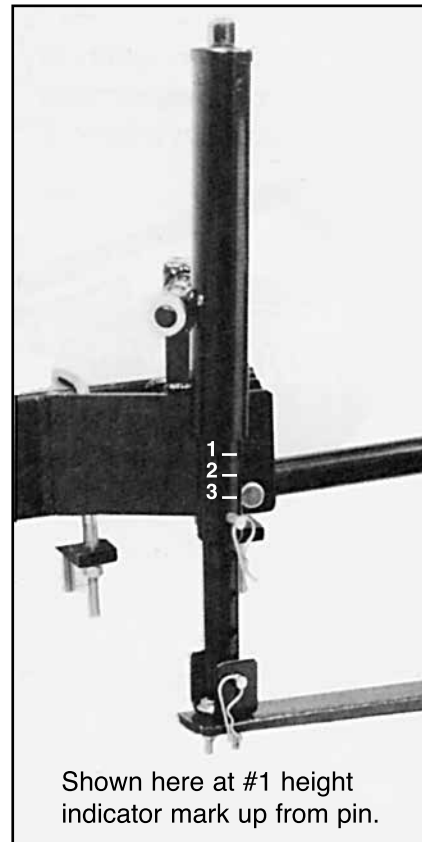

Shown here at #1 height indicator mark up from pin.

HOOK-UP PROCEDURES

Be sure the trailer wheels are chocked.



NOTE:

This is a Tried and True way we feel will make hooking up your trailer easier. Once you get practice under your belt you may not need to take these steps. You may find your own way of hooking up that may be easier under your own particular circumstances.

- 1 Insert the hitch bar into the 2" square hitch receiver on the tow vehicle. Secure the hitch bar with the pin and clip.

(NEVER insert the hitch bar without immediately pinning it in place.)

- 2 With the hitch bar pinned in the tow vehicle, back toward the travel trailer as if you were going to make an attempt to hook-up. Stop about 18" from the hitch box.

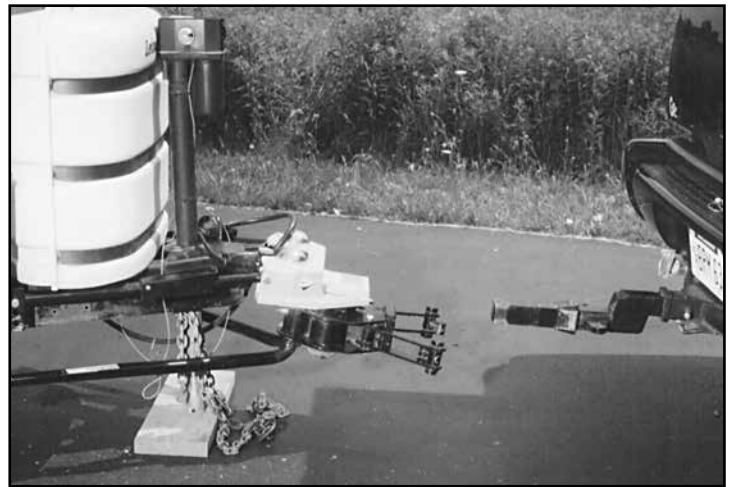

HOOK-UP PROCEDURES cont.

- 3** After placing your vehicle in park, observe the angle at which the hitch bar is sticking out from the tow vehicle.



- 4** After you have observed this angle, remove the hitch bar from the vehicle and place it into the hitch box on the travel trailer.

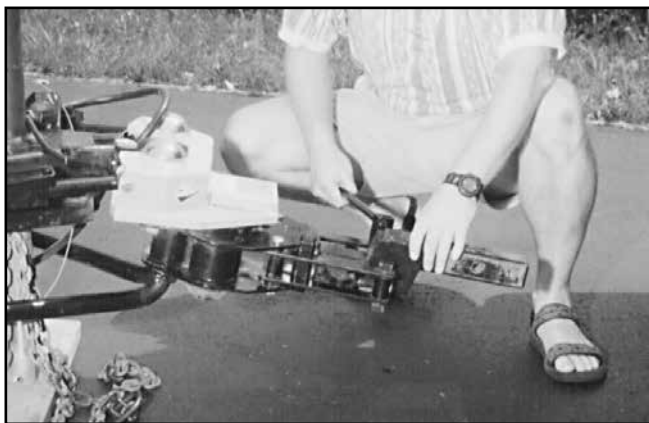
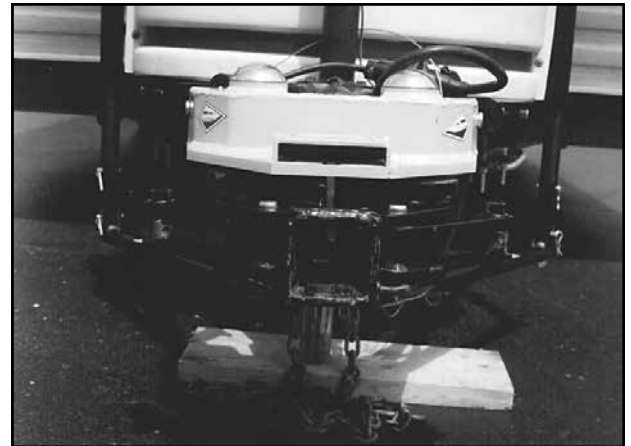
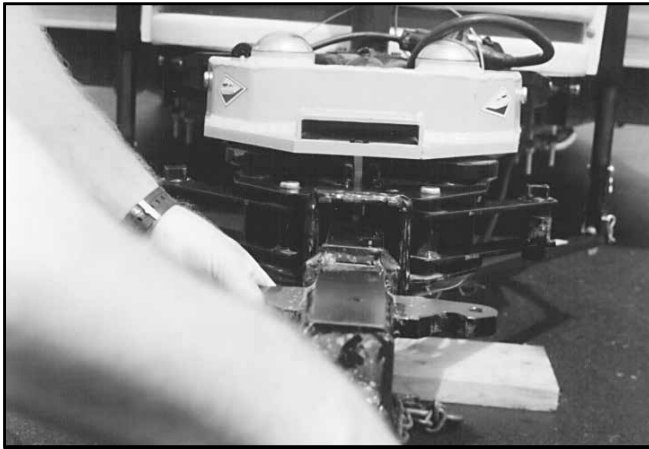

Secure it with (1) OCL.

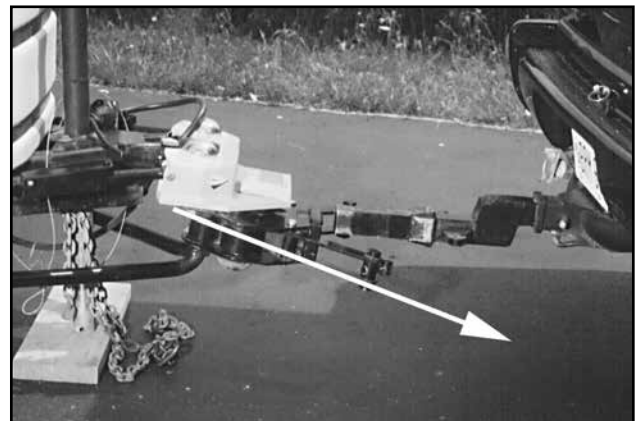

Observe that angle.

HOOK-UP PROCEDURES cont.

- 5** The goal is to have both angles matching or mirroring each other. Remembering the angle sticking out of the tow vehicle, maneuver the angle of the hitch box by pushing down or pulling up on the spring bars. When using the Standard

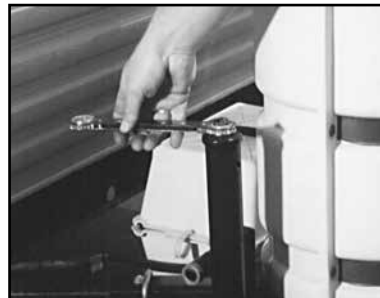

Jack System, this can be done by tensioning or un-tensioning the spring bars with the screw jacks. When using the Swift Lift System, you can lengthen or shorten the support rods by removing the pin in the center of the support rod and pinning it through a different hole. (Think of this operation like maneuvering a wheelbarrow- your arms are the jacks/support rods and the wheelbarrow handles are the spring bars. Pushing down will tilt the hitch head up and pulling up will tilt the hitch head down.)

- 6** Once you see the hitch box angle matches the angle from the tow vehicle, remove the hitch bar from the hitch box on the travel trailer and replace it in the tow vehicle pinning securely into place.



IMPORTANT:

Put the transmission in park and set the parking brake so the tow vehicle will not roll and pull the hitch bar partially out of the hitch box.

IMPORTANT:

Be sure the tow vehicle wheels are straight ahead when backing the hitch bar into the hitch box and when pulling out of the hitch box with the tow vehicle.

HOOK-UP PROCEDURES cont.

HITCH HINT:

If an OCL locks in with very little force, unlatch it and swing it back out. Lengthen the adjustment screw by turning the screw out, 1/2 turn at a time until it latches firmly. When properly adjusted, it takes some force (like a pair of vice-grip pliers) to get the latch firmly seated in its latched position.



If an OCL is too hard to lock in, do not force the latch into its latched position. Shorten the adjustment screw by turning the screw in 1/2 turn at a time until it latches firmly. When properly adjusted, it takes some force (like a pair of vice-grip pliers) to get the latch firmly seated in its latched position.



8

Finish the connection by camming the hitch bar securely into place with the OCLs. Install the safety keys, connect the safety cable, safety chains, and electrical cord.



CAUTION:
**(DO NOT TOW WITH-
OUT SAFETY KEYS IN
PLACE!)**



IMPORTANT:

The routing for safety chains is between and under the spring bars.

7

Back up toward the travel trailer again. This time stop 3-4 inches from the hitch box and adjust the height of the hitch box opening by moving the travel trailer tongue jack up or down. Center the hitch bar in the opening. Back the hitch bar into the hitch box. Don't be afraid to be somewhat aggressive.

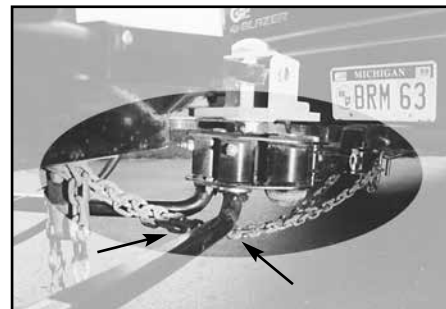

Between and under spring bars.



HOOK-UP PROCEDURES cont.

9A

Standard and I/C Jack Kits: Engage weight distribution to your towing position by tensioning the spring bars using the spring bar jacks. Also use the height indicator marks on the jacks making sure both sides are equal height for towing. Usually 3rd height indicator mark or less, depending how much tongue weight needs to be distributed.

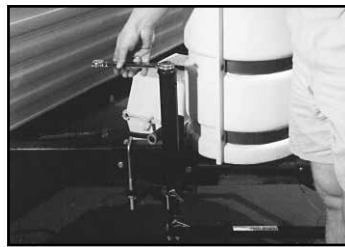
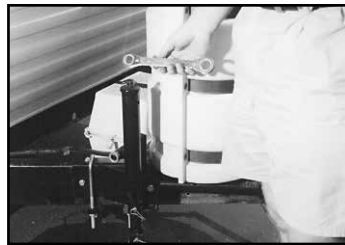

9B

Swift Lift Kit: Un-pin the wire bale pin that attaches the spring bar support rod to the spring bar and rotate the support rod up so it is parallel to the trailer A-frame. Use the wire bale in to secure the support rod to the strut bar while you are towing. You don't need to completely remove the support rod, but only rotate it up and out of the way while you are towing. (see photo below.)

Next, you will need to apply tension to the weight distribution spring bars. Hook the proper chain link on the the frame bracket hook (normally the 2nd or 3rd link) and use the provided handle to life the spring bars and snap the brackets over center. In some cases you may need to extend your trailer tongue jack to life the front of the trailer and the back of the vehicle in order to reach the frame bracket hook with the proper chain link. **IMPORTANT: AFTER SNAP UP BRACKETS ARE LIFTED INTO POSITION, INSERT THE LARGE COTTER PIN THROUGH THE HOLE IN THE SIDE OF THE FRAME BRACKET TO INSURE THE BRACKET CAN'T COME UNLATCHED.**

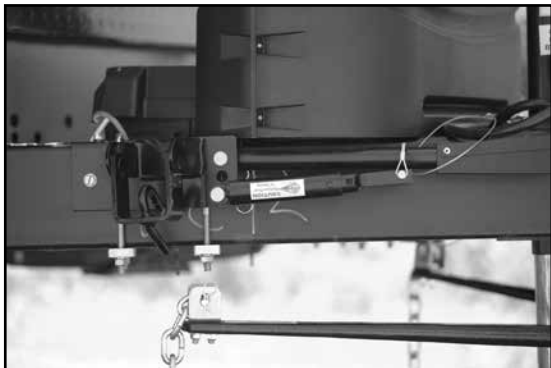

10

Remove the foot and raise the tongue jack of the travel trailer completely up and out of the way. Hook up safety chains and 7 pin electrical cable, remove the tire chock and you are ready to travel.



IMPORTANT:

Before you tow, pull forward and make sharp turns both ways to be sure everything works freely.

Especially check the break-away cable and electric cord to be sure they don't bind or get pinched. In most cases, the best routing for the break-away cable, and electric cord is over the top of the main unit since the Hensley Arrow™ doesn't allow the coupler to turn on the ball.



Complete normal hook-up of safety chains, electric plug, and break-away switch cable. In some cases these will have to be lengthened due to the Hensley Arrow's™ extra length which increases the distance between the trailer and the tow vehicle approximately 12 inches.

INSTALLATION AND SAFETY CHECKLIST

Did you grease the trailer ball before attaching the main unit to the trailer coupler?

Did you put lots of grease on the spring bars before you inserted them into the bottom of your Hensley™ Hitch?

If your installation uses U-bolts, did you use a torque wrench and tighten the U-bolts to 45 ft. lbs. torque? (Note: be sure to torque the U-bolts back to 45 ft. lbs. after the first 200 towing miles).

If your installation uses U-bolts, did you drill holes and install 2 self-tapping shear bolts through each frame bracket and into the trailer frame?

Are the strut bars mounted to be parallel to the top of the trailer A-frame?

Are both strut bars tightened to be firm and not move back and forth on the mounting pins?

Are the OCL latches adjusted so they will close using some pressure with the OCL wrench, but not able to open and close by hand?

Are the safety chains rerouted correctly? (see page 25 for proper routing of safety chains)

Did you remove the foot pad on the tongue jack?

Did you properly tension up your weight distribution system? (The screw jacks on the standard system should be tensioned up to the middle mark on the jack to begin with. Chain links on the Swift Lift system should be hooked on to the frame brackets with 2-3 open chain links showing to begin with.

Important! Be sure to fill out the warranty registration found opposite the inside cover of this owner's manual and mail it in.

UNHOOKING PROCEDURES

- 1** Chock travel trailer tires.



- 2** Put the travel trailer tongue jack down, raising the travel trailer enough to take the tongue weight of the trailer off the tow vehicle. (This can be measured prior to hooking up or could be the measurement given when the hitch was ordered - measurement from the ground to the top inside of 2" receiver on vehicle - trailer not hooked up and vehicle running).



- 3** Start un-tensioning the spring bars using the spring bar jacks and the supplied ratchet wrench. As you un-tension them, you will start to see the spring bar become "sloppy loose." Continue un-tensioning the jacks until either they stop or until they start to tighten again (this is called reverse tension). This process will take into account any angles between your vehicle and the travel trailer (side to side/front to back).



- 4** Disconnect electrical cord, safety cable and safety chains. Remove safety keys and open "OCLs."

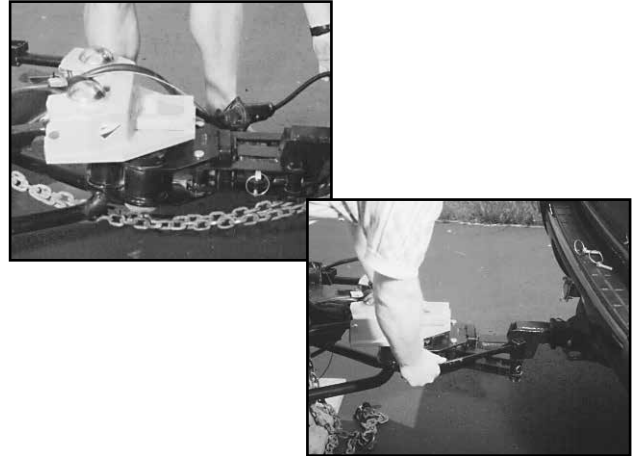

- 5** Pull away from travel trailer.

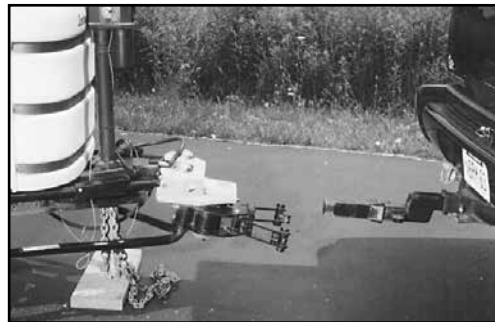

Level for sleeping and refrigeration.

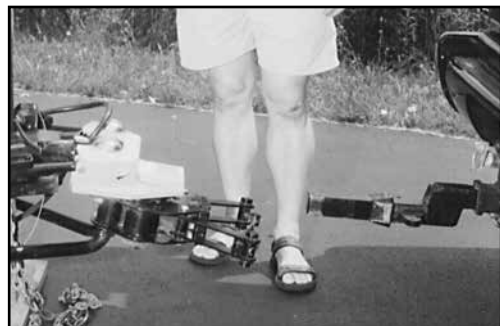

HENSLEY TOWING SYSTEM HOOKING-UP

1. With the hitch bar pinned in the tow vehicle, back toward the travel trailer as if you were going to make an attempt to hook-up. Stop about 18” from the hitch box.
2. After placing your vehicle in park, observe the angle at which the hitch bar is sticking out from the tow vehicle.
3. After you have observed this angle, remove the hitch bar from the vehicle and place it into the hitch box on the travel trailer. Secure it with (1) OCL. Observe that angle.
4. The goal is to have both angles matching or mirroring each other. Remembering the angle sticking out of the tow vehicle, maneuver the angle of the hitch box by tensioning or untensioning the spring bars with the spring bar jacks or support rods. (This is like maneuvering a wheelbarrow. Your arms are the jacks or support rods and the wheelbarrow handles are the spring bars.)
5. Once you see the hitch box angle matches the angle from the town vehicle, remove the hitch bar from the hitch box on the travel trailer and replace it in the tow vehicle pinning securely into place.
6. Back up toward the travel trailer again. This time stop 3-4 inches from the hitch box and adjust the height of the hitch box opening by moving the travel trailer tongue jack up or down. Center the hitch bar in the opening.
7. Back the hitch bar into the hitch box. Don’t be afraid to be somewhat aggressive.
8. Finish the connection by camming the hitch bar securely into place with the “OCL’s.” Install the safety keys, connect the safety cable, safety chains, and electrical cord.
9. Engage weight distribution to your towing position by tensioning the spring bars using the spring bar jacks or Swift brackets/chains. Also use the height indicator marks on the jacks making sure both sides are equal height for towing.
10. Remove the foot, raise the tongue jack of the travel trailer completely up and out of the way. Put away tools and unchock wheels.
11. Lastly, check the strut assemblies, being sure they are tight.





HENSLEY TOWING SYSTEMS UNHOOKING

1. Chock travel trailer tires.
2. Put the travel trailer tongue jack down, raising the travel trailer enough to take the tongue weight of the trailer off the tow vehicle. (This can be measured prior to hooking up or could be the measurement given when the hitch was ordered -measurement from the ground to the top inside of 2" receiver on vehicle - trailer not hooked up and vehicle running).
- 3A. (Standard and I/C Jack Kits) Start un-tensioning the spring bars using the spring bar jacks and the supplied ratchet wrench. As you un-tension them, you will start to see the spring bar become "sloppy loose". Continue un-tensioning the jacks until either they stop or until they start to tighten again (this is called reverse tension). This process will take into account any angles between your vehicle and the travel trailer (side to side/front to back).
- 3B. (SwiftArrow™ /SwiftCub™) Un-pin and release the snap-up bracket. Un-pin and lower the Support Rod and capture the spring bar in the fork. Re-pin to the spring bar to hold in place.
4. Disconnect electrical cord, safety cable and safety chains. Remove safety keys and open "OCL's."
5. Straighten vehicle wheels and pull away from travel trailer. Level trailer for sleeping and refrigeration.
6. TIP: When you unhook correctly, your hitch will be at the correct angle for your next hook-up.

MORE HITCH HINTS

Since not all campgrounds have pull-through lots and sites are unlevel, this section will give you tips on dealing with the phenomenon of hooking and unhooking at unusual angles.

The following exercise will help you better understand hooking and unhooking with the Hensley Arrow™ or Cub™ and why we compare the jacks or support rods to two arms and the spring bars to wheelbarrow handles.

-  Do this procedure without the vehicle by putting the hitch bar in the hitch box and fastening the OCL on each side. (Not hooked up to tow vehicle)
-  If using Jack Kit, fully extend the jacks.
-  Tension one side all the way up watching the angle changes of the hitch bar. Tension the other side all the way up noting further angle changes.
-  If using the Swift Lift Kit, capture the spring bars with the fork on the Support Rods. Pull the center pin out of the Support Rod, fully extend it and replace the center pin using a different hole. Note the changes in the angle of the hitch head.

This will give you an idea of how the jack/spring bar combination or the support rods will hold the hitch head at the **SAME** angle you unhooked from.

WE APPRECIATE YOUR BRIGHT IDEAS!

If you discover an easier or helpful method for installing the Hensley Arrow™ or Cub™ or have a suggestion for improvements, please call us at:

1-800-410-6580

or write to us:

TOW SAFE LLC

151 Shafer Drive • Romeo, Michigan 48065

e-mail: info@hensleymfg.com
internet: www.hensleymfg.com

MAINTENANCE

Spring bars should be greased before an extended trip and at 500 mile intervals.
(Cannot be over greased)

- There are two options for greasing the spring bars.

1 Use a grease gun on the grease zerks provided. (Recommended) Fill them until you see grease come out of the bottom of the housing. Note: Squeaking or groaning around turns usually means the bars could use more grease.

2 Remove the spring bars and apply grease directly to the round end of the spring bars and spring bar bushing. Use caution to keep dirt off the grease portion of the spring bar. (Greasing the bars by hand should be done during initial installation as well.)

 To remove the spring bar, remove the pin from the spring bar U-bracket and jack assembly at the rear of the spring bar. If your Hensley Arrow™ came equipped with the heavy duty 1400# spring bars, you will need to unscrew the zerk fitting off the threaded bushing first and then rotate the bar around toward the vehicle until it drops out of the housing. Then replace zerk back onto bushing tightly. If equipped with 600# or 1000# bars you do not need to remove the zerk. Simply rotate bar until it drops out.

 To reinstall spring bars, insert the round end of the spring bar into the bushing and align the center of the groove with the zerk fitting. Apply upward pressure until the bar locks in place. If the bar falls out with downward pressure, you may need to adjust the retainer pin 1/2 turn at a time and repeat the process.

It is still a good idea after greasing the bars by hand to finish filling the housing using a grease gun on the zerks themselves.

- Grease spring bars every 500 miles (Can't over grease)
- Check the U-Bolts which clamp the frame brackets to the trailers A-frame within the first 200 miles after installation and every 5000 miles thereafter. TORQUE THESE NUTS TO 45 ft. lbs.
- It is very important to check that the strut bars are tight and will not move when gripped and shaken. If loose, tighten square nut. Check these at every hookup, on a level, flat surface.
- Periodic greasing of the hitch ball and coupler will prolong the life of these parts.
- A light coating of silicone spray on the wedges of the hitch bar and hitch box will make latching and removal of the hitch bar easier.
- Never oil or lubricate the internal mechanisms of the jack assemblies.
- Periodic paint touch up is recommended for the Hensley Arrow™ or Cub™ hitch on a regular basis. You may find a close match on paint colors at any hardware store.

Note: Tow Safe LLC cannot supply touch up paint.

INSPECTION

- ☞ Check the U-bolts which clamp the frame brackets to the trailers A-frame within the first 200 miles after installation and every 5,000 miles thereafter. Torque these nuts to 45 ft. lbs.
- ☞ Check for proper strut adjustment at each hookup. (ARE THEY TIGHT)?
- ☞ Check the nuts that attach the spring bar U-brackets to the spring bars. Torque these nuts to 30 ft. lbs.
- ☞ Check to see that all pins and clips are in place with the clips pushed through to the rounded position.
- ☞ Inspect the complete unit for any unusual wear or damage.

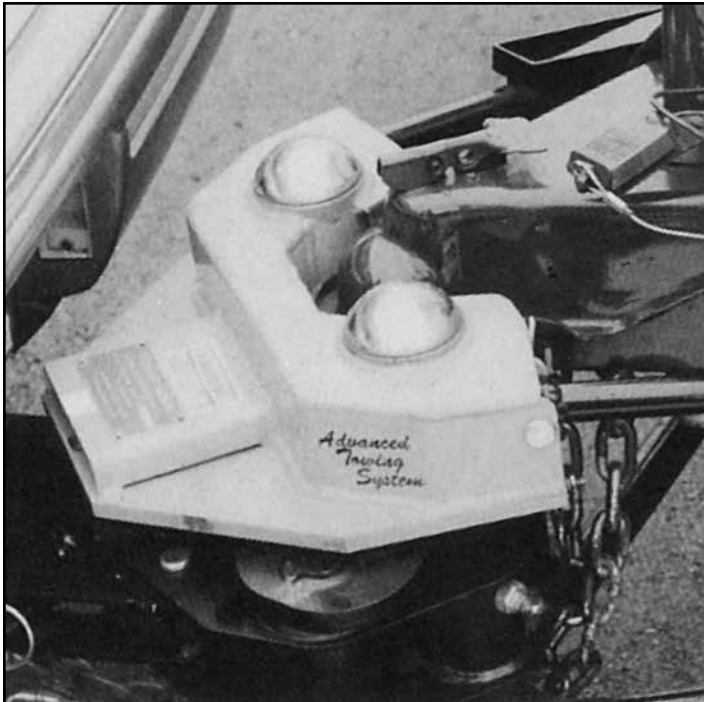

WARNING

DO NOT EXCEED

ARROW:

**MAXIMUM GROSS
TRAILER WEIGHT
14,000 LBS**

**MAXIMUM GROSS
TONGUE WEIGHT
1,400 LBS**

CUB:

**MAXIMUM GROSS
TRAILER WEIGHT
6,000 LBS**

**MAXIMUM GROSS
TONGUE WEIGHT
600 LBS**

HENSLEY HITCH BAR EXCHANGE CLUB

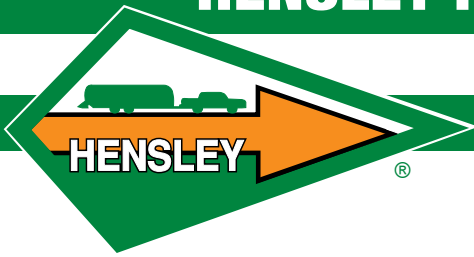

The Hitch Bar Exchange Club is available to all original owners or warranty purchasers of the Hensley Arrow™ or Cub™ towing system.

It allows you, the original owner, to exchange your hitch bar for a small shipping and handling fee.

NOTE:

Any alterations or welds added to the hitch bar will void the warranty on the hitch bar itself and cannot be exchanged through the Exchange Club. It is the customers responsibility to determine which hitch bar will best suit their application. If you have any questions or need help please call our toll free number and speak to one of our representatives.

We will charge a deposit plus shipping and handling for your new bar and issue a return authorization number for the old bar.

To complete the exchange, return your old hitch bar to the address below and we will refund the cost of the hitch bar. You may use any courier service you choose to complete the return.

You must call and get a return authorization number to receive any refunds.

It is important to clearly mark your name, address and RA# inside the box that you return.

*****Exchanges are only processed through Tow Safe LLC factory direct and not through dealers. Please call 1-800-410-6580*****

FOR HITCH BAR EXCHANGE AND WARRANTY RETURNS

SHIP TO:
TOW SAFE LLC
151 Shafer Drive
Romeo, MI 48065

Frequently Asked Questions

Question: Why does the trailer shift to the left or right when braking?

Answer: This is a common question we get with a Hensley Arrow™ or Cub™. The trailer wants to shift to the left or right because of the way the linkage system is designed. A feeling of the trailer bumping the vehicle is felt. This is the result of the trailer brakes not being applied soon enough. The trailer is actually traveling faster than the vehicle and has more momentum so it takes more to slow it down than your vehicle, hence the bumping feeling occurs. Most brake controllers have a Gain Control that can be adjusted so the trailer brakes will come on sooner. Tweak your brake controller so your trailer brakes are being applied shortly before your vehicle brakes. This should eliminate that feeling on mid to heavy stops.

Question: How tight should the strut bars be?

Answer: Good and tight. Generally finger tight and 1/2 turn more. They should not rattle on the pins. You do not want to put all your weight behind you just to get the nut to turn another flat turn. That's too tight. Make it a maintenance check every time you hookup. They WILL loosen up a bit as you tow for several miles and hook and unhook a few times. The strut bars are your sway control. If they are loose, you will have sway.

Question: How much should I tension the jack assemblies?

Answer: Each combination will be different as to how much tension you apply. A heavier trailer on a lighter suspension vehicle will require more tension than a lighter trailer on a heavier suspension. The feel of the ride is what you are looking to achieve since sway is eliminated no matter how much you tension the jacks. Generally, most people need to tension the jacks up between the 2nd and 3rd marks or higher.

Question: The spring bars tend to fall out of the housing when I un-tension the jacks? Why?

Answer: Chances are the spring loaded retainer pin on the grease fitting has not locked into the groove of the spring bar. You may need to adjust the grease fitting in or out a 1/2 turn at a time until the bar locks for proper installation. (See Fig. 1-18, Page 15)

Question: Can I weld the frame brackets onto the trailer frame instead of using the UBolts?

Answer: **WE DO NOT RECOMMEND IT.** The frame brackets are designed to slide when too much force is put on them from the strut bars. If the brackets don't slide then it's possible for the strut bar to be damaged.

Question: I have an aluminum Alco frame on my trailer. Does that change the install process?

Answer: With an Alco frame, you do not use the U-Bolts because they can crush the frame when applying the torque. Instead we use a 1" spacer and bolts with nuts & washers. Everything else stays the same.

Question: I recently bought a new tow vehicle and need to exchange my hitchbar for a different offset. What's the procedure for doing this?

Answer: As long as you are the original owner or have purchased a warranty you can exchange your hitchbar for a different offset. Call us with your new tow vehicle measurement and our Hensley specialists will help you decide which hitchbar would be a better suited for your combo. We will charge you for the new bar plus a shipping & handling fee. See page 33 for hitchbar exchange info.

Frequently Asked Questions cont.

Question: I am using a 2” hitchbar offset now with my current setup. Can I get other offsets from your company if needed with a different vehicle?

Answer: We do offer 5 different hitchbars depending on the height differences between your trailer and vehicle. They come in Straight, 2”, 4”, 6” and 8” offsets.

Question: Can the hitchbar offset rise up as well as drop down out of the vehicle?

Answer: Yes, although most offsets drop down, some vehicle/trailer combos require the offset to rise up out of the vehicle to make everything level. If you are not sure which way it goes, try it both ways.

Question: What is the weight rating of the Hensley Arrow™ or Cub™ ?

Answer: The weight rating of the Hensley Arrow™ is up to 14,000 lbs trailer weight and 1400lbs tongue weight. The weight rating of the Hensley Cub™ is up to 6000 lbs trailer weight and 600lbs tongue weight.

Question: I’ve heard that hooking up can be difficult at times. Is there any helpful tips on making it easier?

Answer: Hooking up can be difficult at times but not impossible. Practice, practice, practice makes perfect. The idea is to mirror the angles to each other using your jack assemblies or support rods to change the angle of the hitchbox. Spraying some silicone spray on the bar or inside the hitchbox will help. The Hitch Helper is another helpful tool in hooking up. You can call us or purchase on our website: www.hensleymfg.com

Question: How often should I grease the ball?

Answer: Grease the ball when you first install it and once a year after that.

Question: How often should I grease the spring bars?

Answer: The spring bars should be greased liberally every 500 miles. You cannot over grease them but it is also very important that they do not run dry. Damage can occur.

Question: Does the Lifetime Warranty transfer if I sell my Hensley Arrow™ or Cub™ hitch?

Answer: No, The Lifetime Warranty is only good for the original owner, however it may be possible for the 2nd owner to purchase a Lifetime Warranty from us if it meets certain requirements. Call for details!

