



THE OUTDOOR
GREATROOM
COMPANY

Ready to Finish Outdoor Fire Pit Kits

Installation Instructions for Square and Linear
Ready to Finish Fire Pit Kits





IMPORTANT



Please consult your Crystal Fire® Plus instruction manual for detailed instructions and important information related to the burner installation including: lighting and operating instructions, safety information, and proper tightening of connections with two wrenches.

DO NOT ATTEMPT TO INSTALL CRYSTAL FIRE® PLUS BURNER WITHOUT CONSULTING THE CRYSTAL FIRE® PLUS OWNER'S MANUAL.

CONTENTS

1. About Your Fire Pit _____	2
a. Required Tools	
b. Included With Your Fire Pit	
2. Fire Pit Requirements _____	3
a. Unpacking	
b. Surrounding clearances	
3. Gas, Electric and Burner Installation _____	4
a. Gas and Electrical Connections	
b. Burner Installation	
4. Finishing _____	5
a. Fire Media Installation	
b. Wind Guard Installation	
c. Finishing	
5. Operating Instructions	5
6. Warnings _____	6

1. ABOUT YOUR FIRE PIT KIT

A. REQUIRED TOOLS

- Utility Knife

To cut and remove packaging

- Open Ended Wrenches (7/8" Wrench and 3/4" Wrench) and an adjustable wrench depending on other gas fitting sizes.

To secure gas connections

- Phillips Screw Driver or drill with Phillips tip.

For attaching the cover plate to the base

B. INCLUDED WITH YOUR FIRE PIT KIT

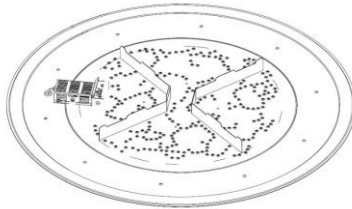

Crystal Fire® Plus Burner
(round burner shown)

(See Crystal Fire® Plus Owner's manual for more installation and operation information)



Ready To Finish Base
(Square base shown)



Control Panel
(DSI shown)

2. FIRE PIT REQUIREMENTS



WARNING



Exposed edges may be sharp, use leather gloves when removing packaging and handling the base.

A. UNPACKING

- Keep all included manuals in a safe place for future reference.
- Two people are recommended to remove the Ready to Finish Base from the packaging.

B. Surrounding Clearances



WARNING



FIRE RISK

Follow all minimum clearance requirements. Failure to provide adequate clearance to combustible materials can result in property damage or loss of life. Please consult your Crystal Fire® Plus instruction manual for more detailed instructions and important information. Clearances are the same for square and linear fire pits.

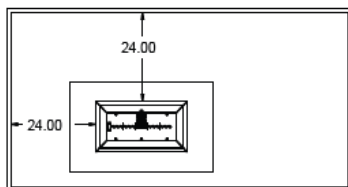

All Dimensions are in Inches

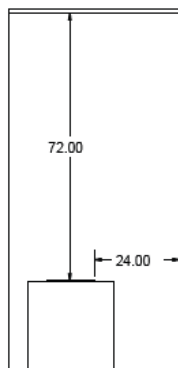
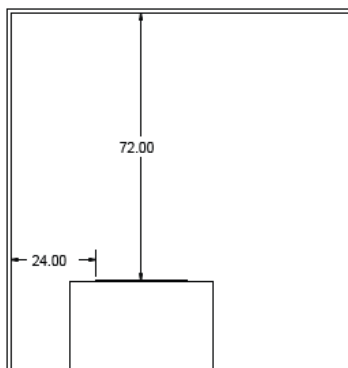

- Place the base in the desired location. It is recommended that the fire pit be installed on concrete or a packed rock surface with a vapor

barrier. It is not recommended to be installed directly on grass.

3. GAS, ELECTRIC AND BURNER INSTALLATION

ATTENTION

Read and understand your Crystal Fire® Plus instruction manual before beginning burner hookups or using the device.
DO NOT USE TEFLON TAPE OR PIPE DOPE ON FLARE FITTINGS.

IMPORTANT

Please consult your Crystal Fire® Plus instruction manual for detailed instructions and important information related to the burner installation including: lighting and operating instructions, safety information, and proper tightening of connections with two wrenches.
DO NOT ATTEMPT TO INSTALL CRYSTAL FIRE® PLUS BURNER WITHOUT FIRST CONSULTING THE CRYSTAL FIRE® PLUS OWNER'S MANUAL.

A. GAS AND ELECTRICAL CONNECTIONS

- See Crystal Fire® Plus instructions for proper gas line pressure requirements.
- See Crystal Fire® Plus instructions for proper electrical requirements for DSI burners.
- Check all connections for leaks. If needed, tighten connection with two wrenches and re-check for leaks.
- Position the Fire Pit over the gas line and electrical.
- For DSI burners only, a GFCI outlet with a weatherproof cover should be installed within the base.

B. BURNER INSTALLATION

- Install the supplied control panel to the base with the supplied fasteners. Refer to the Crystal Fire® Plus installation manual on how to install the VCSV valve and sparker or the DSI control system to the control panel.
- Connect the gas supply line (not included) to the ½" male flare fitting on the valve. Use two wrenches to ensure a gas tight connection and check all connections for leaks.
- Locate and secure the burner to the fire pit using fasteners or brackets provided. For the round burner, remove the four 1/4-20 screws with a Phillips, position the burner over the rivnuts and secure by re-installing the 1/4-20 screws. For the linear burner, remove the two brackets being held in place by 1/4-20 screws, position the burner in the opening and re-install the brackets using the 1/4-20 screws.

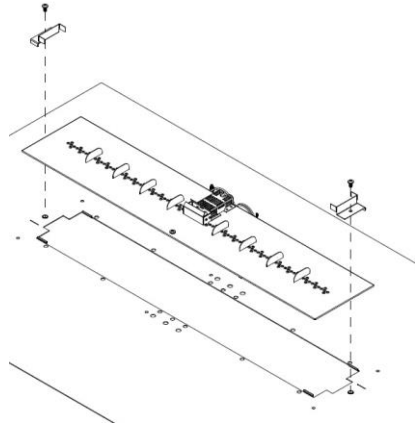
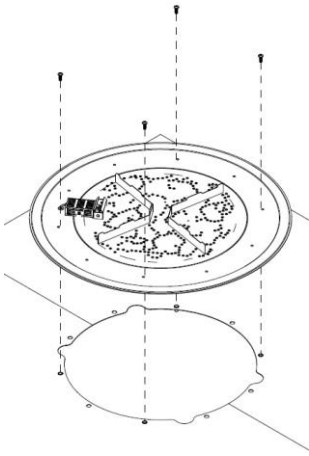

- Following the Crystal Fire® Plus instruction manual, install the media over the

4. FINISHING



WARNING



FIRE RISK

Only non-combustible materials shall be used to finish the Fire Pit Base

burner taking care not to get media in the igniter wind guard cover.

- RTF Fire Pit is designed to be custom finished. Only non-combustible materials shall be used to finish the fire pit base, follow the manufacturers' instructions on how to install the finishing material.
- Ensure the finishing method has provisions to allow water drainage from under the fire pit base.

5. OPERATING INSTRUCTIONS



IMPORTANT



Before operating your RTF Fire Pit ensure all gas connections are properly tightened and thoroughly leak checked. Refer to the Crystal Fire® Plus manual for information on proper leak checking and other critical safety information.



WARNING



FIRE OR EXPLOSION HAZARD

If you do not follow these instructions exactly, a fire or explosion may result causing property damage, personal injury, or loss of life.

6. WARNINGS



IMPORTANT



Please consult your Crystal Fire® Plus instruction manual for detailed instructions and important information related to the burner installation including: lighting and operating instructions, safety information, and proper tightening of connections with two wrenches.

DO NOT ATTEMPT TO INSTALL CRYSTAL FIRE® PLUS BURNER WITHOUT FIRST CONSULTING THE CRYSTAL FIRE® PLUS OWNER'S MANUAL.



WARNING



After consulting the manual and following instructions, remember: before operating, all gas connections must be fully checked for leaks.



WARNING: This product can expose you to chemicals including Carbon Monoxide and Benzene which are known to the State of California to cause cancer or birth defects or reproductive harm. For more information, visit www.P65Warnings.ca.gov

Thank you for purchasing an
Outdoor GreatRoom Company
product! This fire pit was made
with pride in the USA.

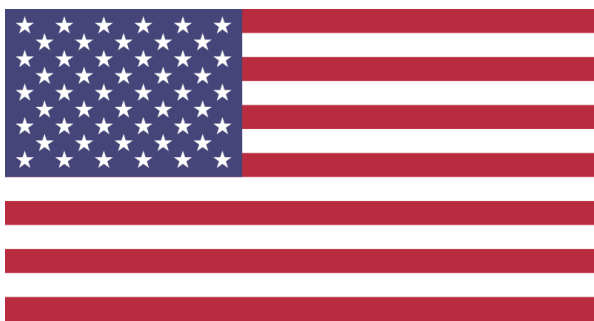

Warranty: Fire pit tables are covered under a 1 year
manufacturer's warranty.

Please visit <http://www.outdoorrooms.com/product-registration>
to register your product.

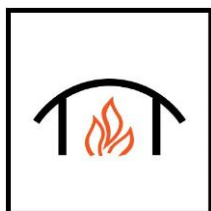

9583 217th St W, Suite 100, Lakeville, MN 55044
Sales@OutdoorRooms.com