



THE OUTDOOR
GREATROOM
COMPANY

Edison Fire Pit Table

Installation Instructions for Edison Fire Pit Table
ED-20



IMPORTANT

Please consult your Crystal Fire instruction manual for detailed instructions and important information related to the burner installation including: lighting and operating instructions, safety information, and proper tightening of connections with two wrenches.

DO NOT ATTEMPT TO INSTALL CRYSTAL FIRE BURNER WITHOUT FIRST CONSULTING THE CRYSTAL FIRE OWNER'S MANUAL.

Contents

Required Tools.....	2
Included with your Fire Pit.....	3
Assembly Instructions.....	4
CF-SPARKER Installation.....	4
Supercast Top Placement.....	5
Gas Connections.....	5
Thermocouple Installation.....	6
Electrode Installation.....	7
Drawer Operation and Propane Tank Installation.....	8
Fire Media Installation.....	9
Burner Cover Installation.....	9
Operating Instructions.....	10

Required Tools



- **Utility Knife**

To cut and remove packaging



- **2 Open Ended Wrenches**

To secure gas connections



- **Leather Gloves**

To protect hands from glass and sharp edges during install



- **One AAA Battery (not included)**

Required for electric spark igniter installation



- **Two people are recommended for this installation**

Included with Your Fire Pit

	Edison Metal Base ED-20-BASE
	Weathered Grey Supercast Top 41-20-WG
	Weathered Grey Supercast Burner Cover 41-20-WG-COVER
	20" Crystal Fire® Plus Burner CFP20
	Ø1.25" Adhesive Foam Pads (4X) 14-6904

Refer to Crystal Fire® Plus manual for items included with Crystal Fire® Plus burners.

Assembly Instructions

1. Un-packaging

- Do not discard any packaging until assembly is complete and unit is tested. Keep all included manuals in a safe place for future reference.
- **Warning:** Exposed edges may be sharp, use leather gloves when removing packaging and handling the base. Do not remove protective cardboard packaging until you have placed the fire pit in its desired final location.

2. Base Placement

- Place base in desired final location.
- Place on a hard, flat surface. Avoid soft surfaces and areas that collect water.
- Refer to Crystal Fire® Plus Manual included with your Crystal Fire® Plus Burner for safety information regarding the placement of your fire pit.



3. CF-SPARKER Installation

- Locate CF-SPARKER inside of Crystal Fire® Plus burner box.
- Remove CF-SPARKER cap and hex nut. Insert AAA battery (not included) with + end out.
- Install CF-SPARKER into control panel as shown below.
- Depress CF-SPARKER button to test your sparker.

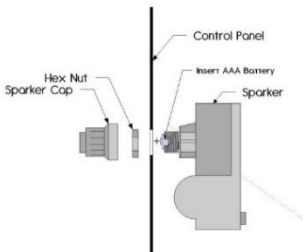

Locate and orient sparker box on control panel as shown. Sparker box must be installed **before** burner valve.



4. Supercast Top Placement

Caution: Top is heavy, two people are required to lift and set into place.

- Remove burner cover before lifting the top to avoid damage to the cover.
- Place adhesive foam pad on top of each leg.
- Carefully lower top onto base. Position top so it is centered on the foam support pads.



5. Gas Connections

Read and understand your Crystal Fire® Plus owner's manual before beginning burner hookups or using the device. Do not use Teflon tape or pipe dope on flare fittings.

- See Crystal Fire® Plus instructions for burner installation.
 - All gas connections were completed at the factory.
- Check all connections for leaks. If needed, tighten connection with 2 wrenches and re-check for leaks.
- Attach burner valve to control panel with provided screws as shown below. Ensure sparker box is installed before this step.

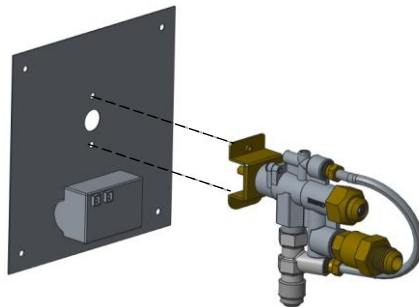

6. *Thermocouple Installation*

- Refer to Crystal Fire® Plus instruction manual for detailed attachment of thermocouple.
- Attach thermocouple to burner valve as shown below.

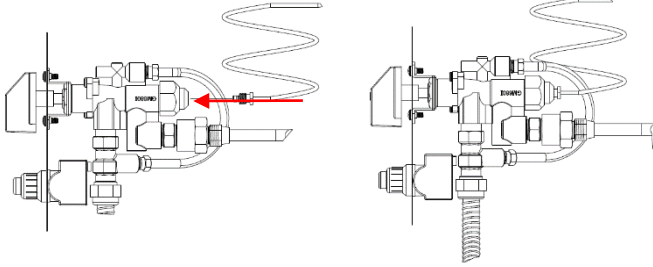

7. Electrode Installation

- Connect igniter and ground wire to sparker box. Both wires can connect to either connection point. The unit will operate in either configuration.
- Test system by pushing the button on the igniter. Consult the troubleshooting section of the Crystal Fire® Plus Burner Owner's Manual if the spark is weak, intermittent, or not present.

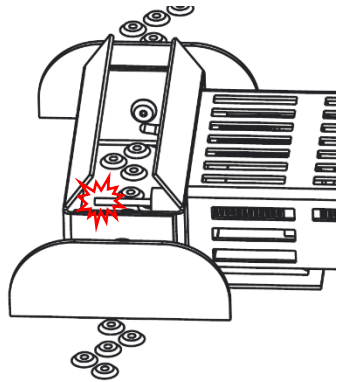
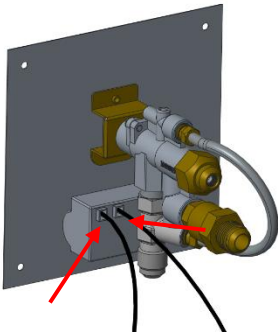

8. *Drawer Operation and Propane Tank Installation*

- Pull the handle attached to the access drawer to slide access drawer out from table. Pull drawer out until it stops along the slider track, as shown below.



- Tilt propane tank and low into drawer from the side.

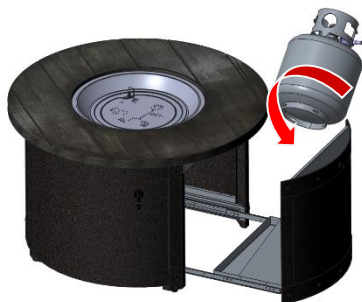

- With the propane tank valve and fire pit valve off, attach the propane regulator to the propane tank. **Hand tighten, do not use a wrench for this connection.**
- Ensure no hoses or wires are contacting the bottom of the burner.
- Push the access drawer with propane tank back into the base, as shown below.



NOTE: Over time the bearings in the door glides may require Re-greasing. Perform re-greasing once a year to maintain the smooth operation of the slides. To re-grease the slides, spray any spray lubricant, such as WD-40, into the bearings as you slide the drawer back and forth.

9. Fire Media Installation

- Scatter all included glass beads, lava rock, or other approved fire media evenly across entire burner surface.

DO NOT OPERATE CRYSTAL FIRE® PLUS BURNER WITHOUT INCLUDED GLASS BEADS OR OTHER APPROVED FIRE MEDIA

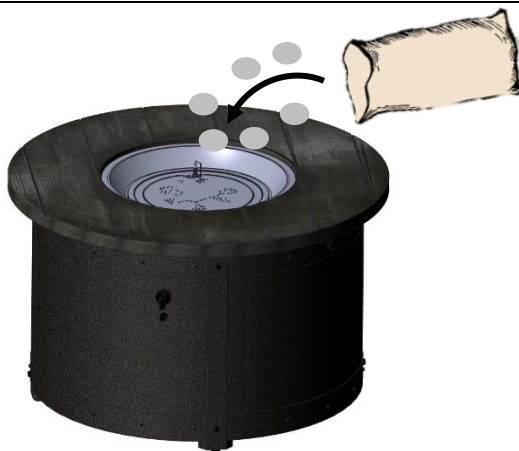

10. Burner Cover Installation

- Carefully lay cover on top of burner.
Make sure burner is cool before attempting to place cover.



DO NOT OPERATE CRYSTAL FIRE® PLUS BURNER WITH BURNER COVER IN PLACE

11. Operating Instructions

Before operating your Edison fire pit, ensure all gas connections are properly tightened and thoroughly leak checked. Refer to the Crystal Fire® Plus Manual for information on proper leak checking and other critical safety information.

- With the valve on the fire pit in the OFF position, open the valve on the propane tank or natural gas supply.
- Double check to make sure there are no gas leaks at the regulator or inlet side of the valve. If leak is detected, immediately shut off the gas supply and wait 5 minutes to allow gas to dissipate. Fix any leaks before proceeding.
- Press the sparker button and hold, look and listen for spark between electrode and grounding rod.
- While depressing the sparker, open the valve.

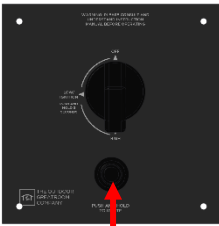

1. Depress sparker

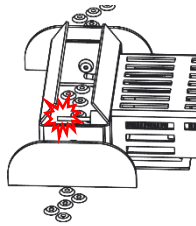

2. Look/listen for spark

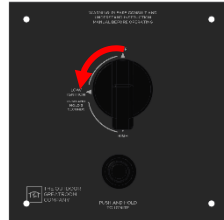

3. Turn valve to ON

- If burner does not light after 10 seconds, close the valve and wait 5 minutes to allow gas to dissipate before attempting ignition again.

Refer to the Crystal Fire® Plus Manual included with your burner for more detailed information on operation, maintenance, and safety of your burner.

IMPORTANT

Please consult your Crystal Fire® Plus instruction manual for detailed instructions and important information related to the burner installation including: lighting and operating instructions, safety information, and proper tightening of connections with two wrenches.

DO NOT ATTEMPT TO INSTALL CRYSTAL FIRE® PLUS BURNER WITHOUT FIRST CONSULTING THE CRYSTAL FIRE® PLUS OWNER'S MANUAL.

WARNING

After consulting the manual and following instructions, remember: before operating, all gas connections must be fully checked for leaks



WARNING: This product can expose you to chemicals including Carbon Monoxide and Benzene which are known to the State of California to cause cancer or birth defects or reproductive harm. For more information, visit www.P65Warnings.ca.gov

Thank you for purchasing an
Outdoor GreatRoom Company
product! This fire pit was made
with pride in the USA.



Warranty: Fire pit tables are covered under a 1-year
manufacturer's warranty. Please visit
<http://www.outdoorrooms.com/product-registration>
to register your product.

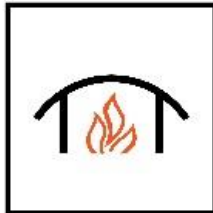

9583 217th St. W. • Lakeville, MN 55044
Toll Free: 1-866-303-4028 • Sales@OutdoorRooms.com