



 THE OUTDOOR
GREATROOM
COMPANY

2022 CATALOG



Bring Home Outside.

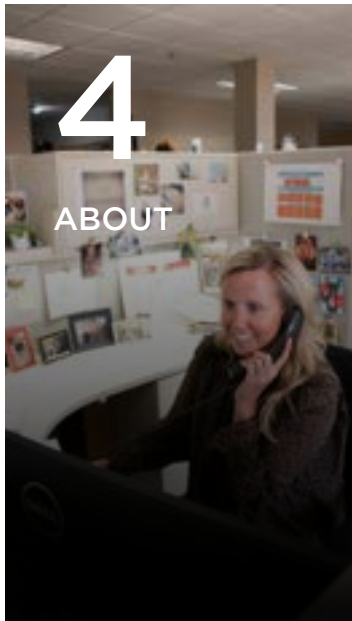

4

ABOUT



7

GAS FIRE PIT TABLES

- 8 Linear Tables
- 11 Rectangular Tables
- 13 Round Tables
- 15 Square Tables



17

READY-TO-FINISH



23

ACCESSORIES

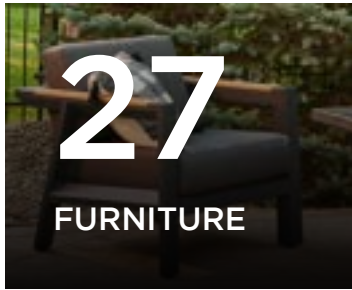

27

FURNITURE

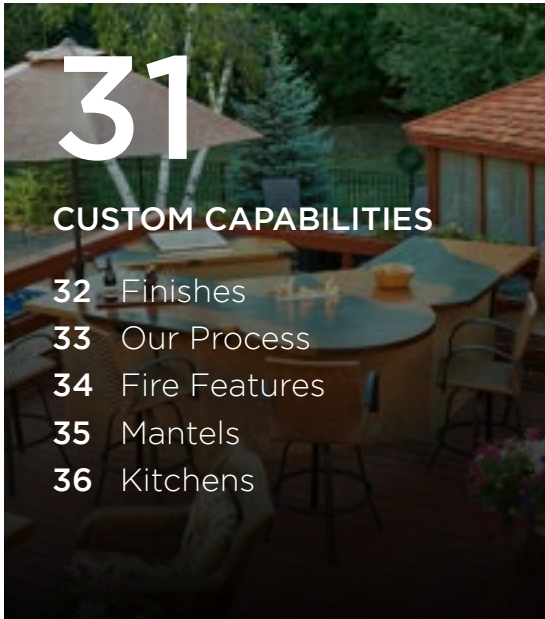

31

CUSTOM CAPABILITIES

- 32 Finishes
- 33 Our Process
- 34 Fire Features
- 35 Mantels
- 36 Kitchens

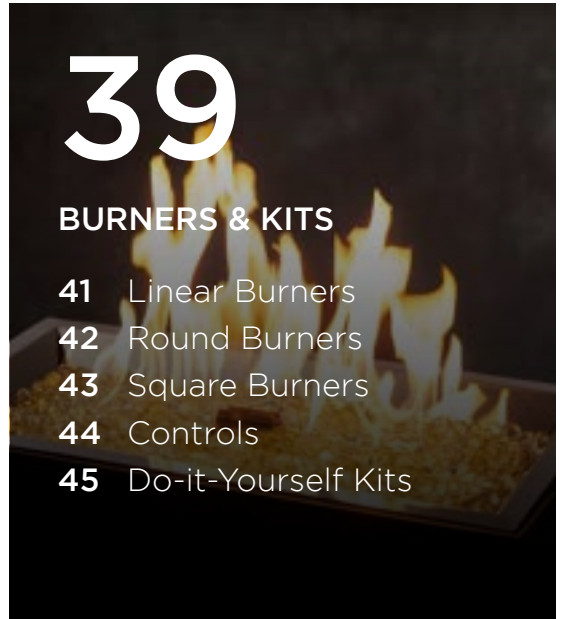

39

BURNERS & KITS

- 41 Linear Burners
- 42 Round Burners
- 43 Square Burners
- 44 Controls
- 45 Do-it-Yourself Kits

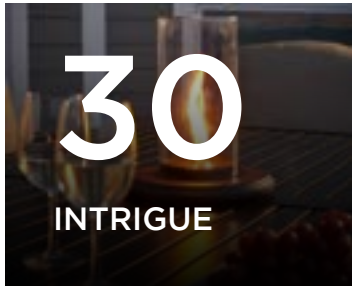

30

INTRIGUE



47

CONTRACT & COMMERCIAL

- 49 Linear DSI Burners
- 50 Round DSI Burners
- 51 Square DSI Burners
- 52 DSI Controls
- 53 Wave Burner

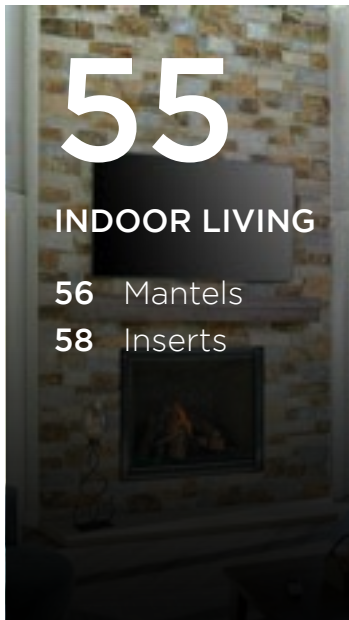

55

INDOOR LIVING

- 56 Mantels
- 58 Inserts

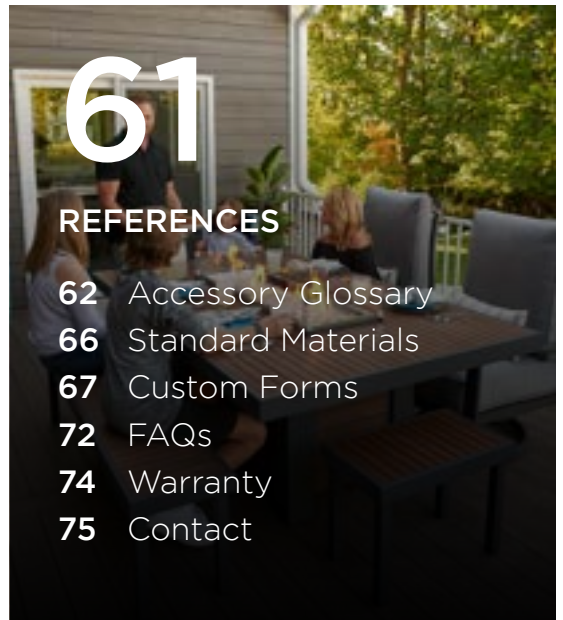

61

REFERENCES

- 62 Accessory Glossary
- 66 Standard Materials
- 67 Custom Forms
- 72 FAQs
- 74 Warranty
- 75 Contact



Who We Are

Located in the heart of Minnesota, The Outdoor GreatRoom Company™ (OGC) manufactures unique, upscale products with design appeal for outdoor living spaces. Products include gas fire pit tables, Crystal Fire® Plus burners and burner inserts, outdoor kitchen islands, outdoor gas fireplaces, outdoor patio furniture, accessories, and custom products for residential and commercial applications.

What We Do

The team behind The Outdoor GreatRoom Company was the first to enter into the gas fire pit category, positioning OGC as the experts on outdoor fire. We are U.S. manufacturers and all of our Crystal Fire® Plus burners and gas fire pit tables are UL and ULC listed for safety.

Our Promise

Let The Outdoor GreatRoom Company help to define your outdoor experience. We set the trends outside as your one-stop-shop for safe products, reliable and friendly service, and innovative technology. From concept to design to delivery, we will ensure your style doesn't stop at the door. Distinctive products for a distinctive lifestyle. Bring home outside.

Our Mission

To bring family and friends together by redefining the home living experience through innovative products and people.

History

In 1975, Dan and Ron Shimek had an inspiration for indoor gas fireplaces that changed an industry and became the foundation of Heat-N-Glo®. Brothers Steve and Gerry joined them and the rest (including over 50 patents) is history. But the Shimeks were never ones to dwell on the past. That inspiration led Dan to launch the first company of its kind in 2003: The Outdoor GreatRoom Company — a company dedicated to an exciting new concept “the outdoor greatroom.”

Why OGC?

OGC is focused on bringing the best and safest product to the market. That's why we have a team with over 20 years of experience manufacturing products in the outdoor living category, and we continue to introduce the best and most innovative products year after year.

Crystal Fire® Plus Burner Technology

The safest and most reliable in the industry.

UL, ULC, & CE Listed

Tested for safety and quality.

Design-Forward Products

Handcrafted in Minnesota from durable, outdoor-rated materials.

We're Like Family

We provide exceptional customer service and reliability.



Creating a lifetime of outdoor experiences through fire.



“We have had a great relationship with The Outdoor GreatRoom Company over the years. Their fire tables have always been trustworthy, excellent quality, provided real heat, and we feel very confident recommending and selling them to our customers.”

—Ashley from *Barbecues Galore*, customers since 2007



RESERVED
FOR THE
DOG

GAS FIRE PIT TABLES



Gas Fire Pit Tables

Light up the night with a cozy, stylish gas fire pit!

Every table includes our patent-pending Crystal Fire® Plus burner technology for the best and safest experience. Add an electronic ignition system to any table for commercial use. All fire tables include clear tempered glass gems.



MG-1242-BLSM-K

Balsam Montego

- Black glass top
- Balsam outdoor resin wicker base
- 12" x 42" Crystal Fire® Plus burner
- Grey glass burner cover included
- Access door conceals standard 20 lb. propane tank in base
- 80,000 BTUs

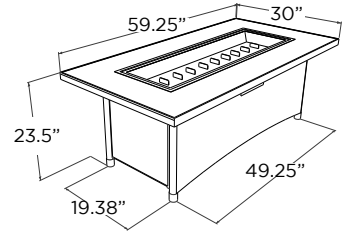

UPT-1242

Black Uptown

- Black tile with Midnight Mist Supercast™ concrete top
- Midnight Storm stucco base
- 12" x 42" Crystal Fire® Plus burner
- Grey glass burner cover included
- Sliding access door conceals standard 20 lb. propane tank in base
- 80,000 BTUs
- Made in USA

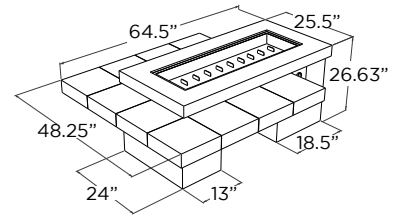

UPT-1242-BRN with optional GLASS GUARD-1242

Brown Uptown

- Brown tile with brown Supercast™ concrete top
- Stony Creek stucco base
- 12" x 42" Crystal Fire® Plus burner
- Grey glass burner cover included
- Sliding access door conceals standard 20 lb. propane tank in base
- 80,000 BTUs
- Made in USA

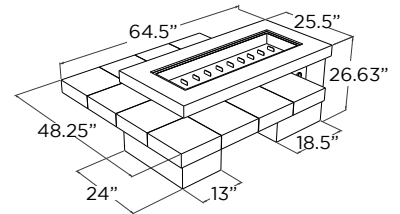

CR-1242-K with optional GLASS GUARD-1242

Cedar Ridge

- Washed Cedar Supercast™ concrete top
- Dark grey composite decking base
- 12" x 42" Crystal Fire® Plus burner
- Matching Supercast concrete burner cover included
- Access door conceals standard 20 lb. propane tank in base
- 80,000 BTUs
- Made in USA

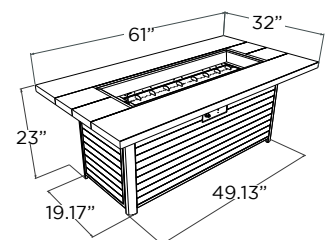



DENBR-1242 with optional GLASS GUARD-1242

Denali Brew

- Brown Everblend™ concrete top
- Corrugated metal base with mocha wood frame
- 12" x 42" Crystal Fire® Plus burner
- Grey glass burner cover included
- Access door conceals standard 20 lb. propane tank in base
- 80,000 BTUs
- Made in USA

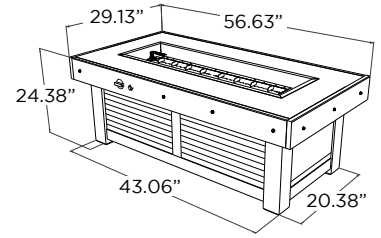

KL-1242-MM

Grey Key Largo

- Midnight Mist Supercast™ concrete top
- Black Fleck stucco base
- 12" x 42" Crystal Fire® Plus burner
- Grey glass burner cover included
- Sliding access door conceals standard 20 lb. propane tank in base
- 80,000 BTUs
- Made in USA

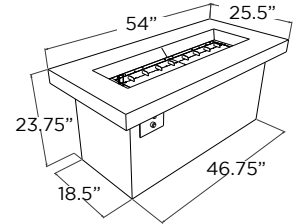

KL-1242-SS with optional GLASS GUARD-1242

Stainless Steel Key Largo

- Stainless steel trim top
- Black Fleck stucco base
- 12" x 42" Crystal Fire® Plus burner
- Grey glass burner cover included
- Sliding access door conceals standard 20 lb. propane tank in base
- 80,000 BTUs
- Made in USA

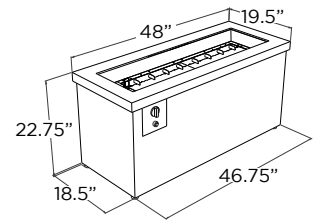

KW-1242-K

Kenwood Dining

- Umber brown composite decking top and base
- Grey powder-coated aluminum framing
- 12" x 42" Crystal Fire® Plus burner
- Grey glass burner cover included
- Access door conceals standard 20 lb. propane tank in base
- 80,000 BTUs

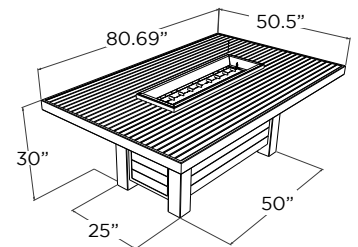

MCR-1242-BLK-K

Monte Carlo

- Black glass top
- Black powder-coated metal base
- 12" x 42" Crystal Fire® Plus burner
- Grey glass burner cover included
- Sliding access door conceals standard 20 lb. propane tank in base
- 80,000 BTUs
- Made in USA

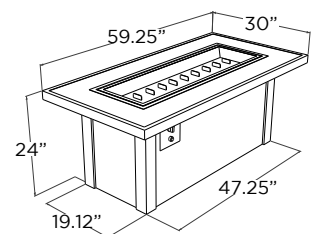



Light up the night.



CV-54

Cove 54"

- Natural Grey, White, or Midnight Mist Supercast™ concrete base
- 7" x 37" Crystal Fire® Plus burner insert inside 12" x 42" plate
- Matching Supercast concrete pedestal included
- Does not fit 20 lb. LP tank in base
- 80,000 BTUs
- Made in USA

Other colors available

White
(CV-54WT)

Midnight Mist
(CV-54MM)

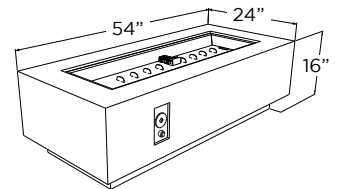

CV-72WT

Cove 72"

- White, Midnight Mist, or Natural Grey Supercast™ concrete base
- 7" x 57" Crystal Fire® Plus burner insert inside 12" x 64" plate
- Matching Supercast concrete pedestal included
- Does not fit 20 lb. LP tank in base
- 100,000 BTUs
- Made in USA

Other colors available

Midnight Mist
(CV-72MM)

Natural Grey
(CV-72)

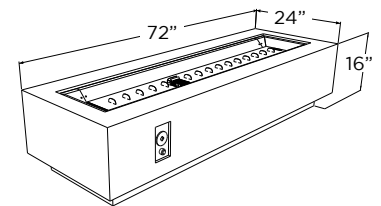



ALC-1224 with optional GLASS GUARD-1224

Alcott

- Antique Timber Supercast™ concrete top
- Whitewashed shiplap base
- 12" x 24" Crystal Fire® Plus burner
- Matching Supercast concrete burner cover included
- Sliding access door conceals standard 20 lb. propane tank in base
- 55,000 BTUs
- Made in USA

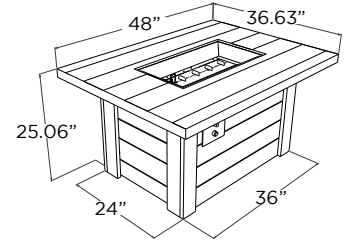

BRK-1224-19-K

Brooks

- Taupe composite decking top and base
- Grey powder-coated aluminum framing
- 12" x 24" Crystal Fire® Plus burner
- Grey glass burner cover included
- Access door conceals standard 20 lb. propane tank in base when included
- 55,000 BTUs

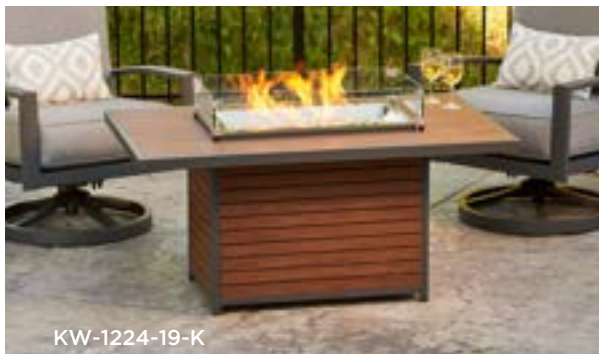
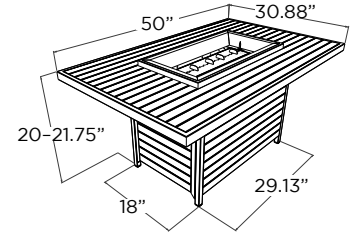

KW-1224-19-K

Kenwood Chat

- Umber brown composite decking top and base
- Grey powder-coated aluminum framing
- 12" x 24" Crystal Fire® Plus burner
- Grey glass burner cover included
- Access door conceals standard 20 lb. propane tank in base when included
- 55,000 BTUs

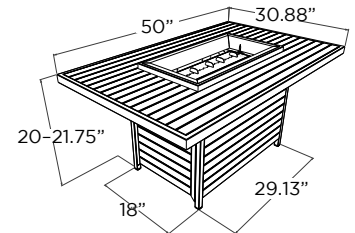

KN-1224

Kinney

- Trillium Everblend™ concrete top
- Black powder-coated metal base
- 12" x 24" Crystal Fire® Plus burner
- Grey glass burner cover included (fits inside base)
- Access door conceals horizontal 20 lb. propane tank — does not fit standard 20 lb. tank
- 55,000 BTUs
- Made in USA

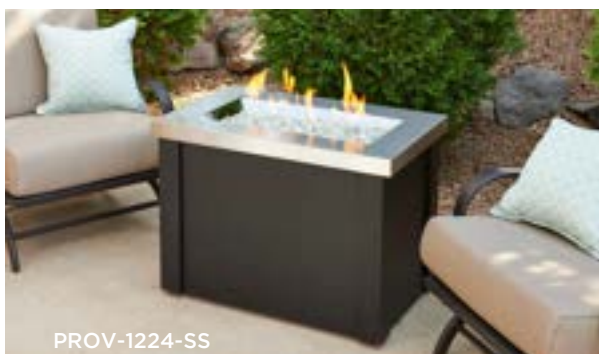
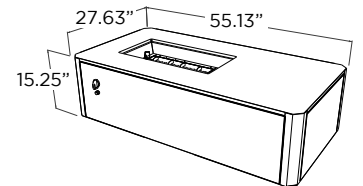

PROV-1224-SS

Providence

- Stainless steel trim top
- Black powder-coated metal base
- 12" x 24" Crystal Fire® Plus burner
- Grey glass burner cover included
- Access door conceals standard 20 lb. propane tank in base
- 55,000 BTUs
- Made in USA

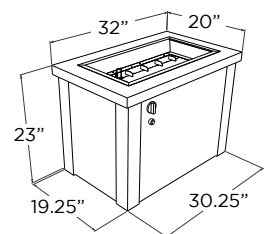



DAR-1224-K

Darien

- Aluminum or Stone Grey Everblend™ concrete top
- Grade A teak wood base
- 12" x 24" Crystal Fire® Plus burner
- Matching burner cover included for aluminum top; grey glass cover included for Everblend concrete top
- Access door conceals standard 20 lb. propane tank in base
- 55,000 BTUs

Top options available

Stone Grey
(DAR-1224-EBG-K)

Aluminum
(DAR-1224-K)

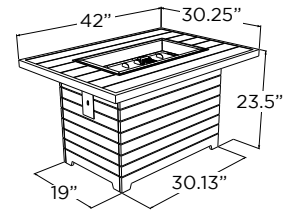
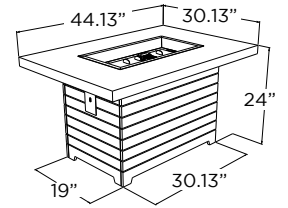

HVGG-1224-K

Grey Havenwood

- Driftwood or Stone Grey Everblend™ concrete top
- Grey powder-coated metal base
- 12" x 24" Crystal Fire® Plus burner
- Grey glass burner cover included
- Access door conceals standard 20 lb. propane tank in base
- 55,000 BTUs
- Made in USA

Top options available

Driftwood
(HVDG-1224-K)

Stone Grey
(HVGG-1224-K)

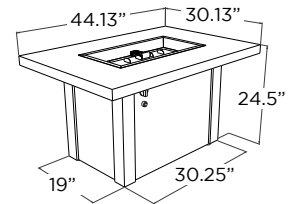

HVDW-1224-K with optional GLASS GUARD-1224

White Havenwood

- Stone Grey or Driftwood Everblend™ concrete top
- White powder-coated metal base
- 12" x 24" Crystal Fire® Plus burner
- Grey glass burner cover included
- Access door conceals standard 20 lb. propane tank in base
- 55,000 BTUs
- Made in USA

Top options available

Stone Grey
(HVGW-1224-K)

Driftwood
(HVDW-1224-K)

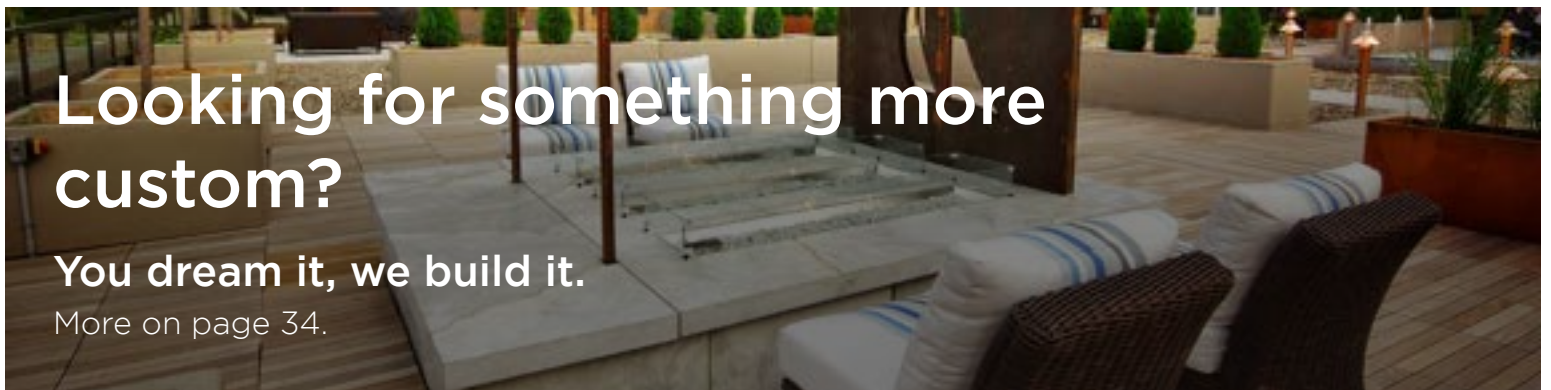
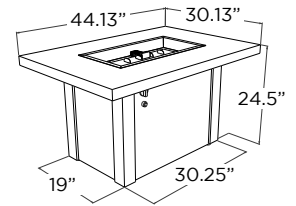

Looking for something more custom?

You dream it, we build it.

More on page 34.



SF-32-K

Brown Stonefire

- Dora brown composite top
- Brown powder-coated aluminum frame with brown mesh base
- 16" Crystal Fire® Plus burner insert
- Matching composite burner cover included
- Access door conceals standard 20 lb. propane tank in base
- 55,000 BTUs

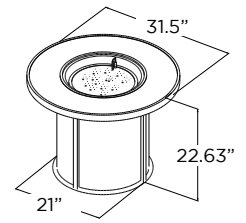

SF-32-GRY-K

Grey Stonefire

- Grey composite top
- Grey powder-coated aluminum frame with grey mesh base
- 16" Crystal Fire® Plus burner insert
- Matching composite burner cover included
- Access door conceals standard 20 lb. propane tank in base
- 55,000 BTUs

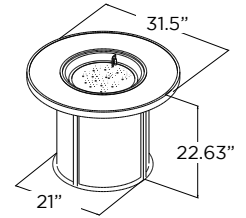

ED-20 with optional GLASS GUARD-20-R

Edison

- Grey Barnwood Supercast™ concrete top
- Pewter Crater powder-coated metal base
- 20" Crystal Fire® Plus burner
- Matching Supercast concrete burner cover included
- Sliding access door conceals standard 20 lb. propane tank in base
- 55,000 BTUs
- Made in USA

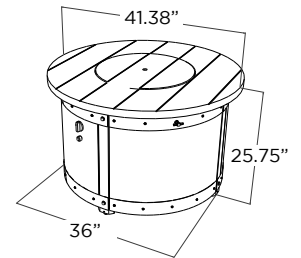

BC-20-MNB with optional GLASS GUARD-20-R

Marbleized Noche Beacon

- Marbleized Noche Supercast™ concrete top
- Brown powder-coated metal base
- 20" Crystal Fire® Plus burner
- Matching Supercast burner cover included
- Sliding access door conceals standard 20 lb. propane tank in base
- 55,000 BTUs
- Made in USA

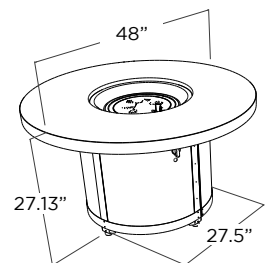

BC-20-WO

White Onyx Beacon

- White Onyx Supercast™ concrete top
- Grey powder-coated metal base
- 20" Crystal Fire® Plus burner
- Matching Supercast burner cover included
- Sliding access door conceals standard 20 lb. propane tank in base
- 55,000 BTUs
- Made in USA

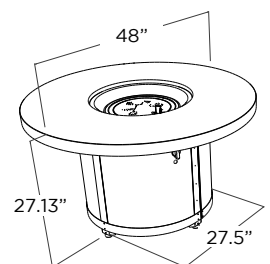



BRON52-K with optional BRON52-CG-TC

Bronson Round Kit

- Build-your-own gas fire pit kit
- 28" Crystal Fire® Plus burner insert inside 42" round plate
- Includes pavers (84), control panel, 2 vent blocks, and tumbled lava rock (72 lbs.)
- Does not fit 20 lb. LP tank in base
- 105,000/106,000 BTUs (LP/NG)
- Made in USA

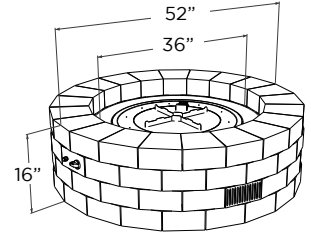

CV-20

Cove 29"

- Natural Grey Supercast™ concrete base
- 20" Crystal Fire® Plus burner
- Grey glass burner cover included
- Does not fit 20 lb. LP tank in base
- 55,000 BTUs
- Made in USA

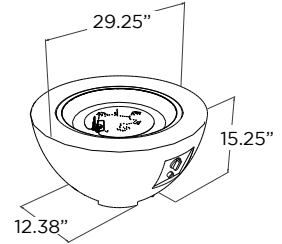

CV-30WT

Cove 42"

- White, Midnight Mist, or Natural Grey Supercast™ concrete base
- 30" Crystal Fire® Plus burner
- Grey glass burner cover included
- Does not fit 20 lb. LP tank in base
- 105,000/106,000 BTUs (LP/NG)
- Made in USA

Other colors available

Midnight Mist (CV-30MM)

Natural Grey (CV-30)

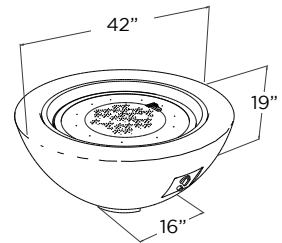

CV-30EMM

Cove Edge 42"

- Midnight Mist, White, or Natural Grey Supercast™ concrete base
- 28" Crystal Fire® Plus burner insert inside round plate
- Does not include burner cover
- Does not fit 20 lb. LP tank in base
- 105,000/106,000 BTUs (LP/NG)
- Made in USA

Other colors available

White (CV-30EWHT)

Natural Grey (CV-30E)

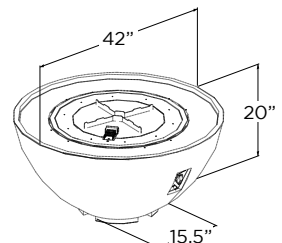



BRON5151-K

Bronson Square Kit

- Build-your-own gas fire pit kit
- 28" Crystal Fire® Plus burner insert inside 42" square plate
- Includes pavers (64), control panel, 2 vent blocks, and tumbled lava rock (78 lbs.)
- Does not fit 20 lb. LP tank in base
- 105,000/106,000 BTUs (LP/NG)
- Made in USA

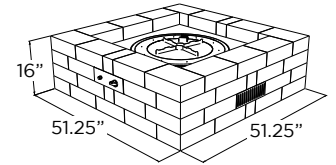

CV-2424 with optional GLASS GUARD-2424

Cove Square

- Natural Grey Supercast™ concrete base
- 24" x 24" Crystal Fire® Plus burner
- Grey glass burner cover included
- Access door conceals standard 20 lb. propane tank in base
- 55,000 BTUs
- Made in USA

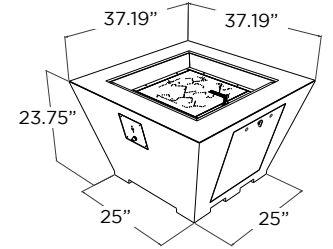

SIERRA-2424-M-K

Sierra

- Mocha Supercast™ concrete top
- Faux stacked stone base
- 24" x 24" Crystal Fire® Plus burner
- Matching Supercast concrete burner cover included
- Sliding access door conceals standard 20 lb. propane tank in base
- 55,000 BTUs
- Made in USA

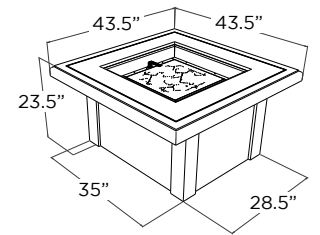

Stylize your outdoor room.



“We have been working with The Outdoor GreatRoom Company for over 13 years because of the people that make up OGC. Their down to earth, top notch professionals design and build reliable indoor and outdoor features sure to enhance anyone’s space.”

—Wayne from Fireplace Stone & Patio, customers since 2008



| READY-TO-FINISH



Ready-to-Finish Fire Pit Kits

Be the visionary for your very own fire pit design!

We supply the structure, and you finish your masterpiece on-site to match your landscaping or exterior design. Ready-to-finish fire pit kits are made from Hardiebacker® fiber cement boarding and G90 steel framing.



Finished Linear Kit

- Made of G90 marine-grade galvanized steel framing and Hardiebacker® fiber cement boarding
- Choose between manual ignition (VCSV) or direct spark ignition (DSI)
- Includes aluminum top, burner insert, two ventilation plates, and standard control panel
- Control panel will either have turn dial or switch depending on ignition type
- Other DSI controls, timers, e-stops, and fire media sold separately
- Recommended for hard piped natural gas or liquid propane installation
- **Custom sizing available** — contact OGC for more information.
- Most do not fit 20 lb. liquid propane tank in base
- Made in USA

See page 34 for custom capabilities.



Square kit with included components.

Linear Kits

NAME	SKU (LP/NG)	BURNER INCLUDED	BTUs	LENGTH	WIDTH	HEIGHT
MANUAL IGNITION (VCSV)**						
48" x 36" Linear Ready-to-Finish Kit	RTF48L-K	BI737	80,000	48"	36"	18"
48" x 36" Tall Linear Ready-to-Finish Kit*	RTF48TL-K	BI737	80,000	48"	36"	21"
60" x 36" Linear Ready-to-Finish Kit	RTF60L-K	BI737	80,000	60"	36"	18"
72" x 36" Linear Ready-to-Finish Kit	RTF72L-K	BI757	100,000	72"	36"	18"
DIRECT SPARK IGNITION (DSI)**						
48" x 36" Linear Ready-to-Finish Kit	RTF48LDNG-K***	BI737DSING	80,000	48"	36"	18"
48" x 36" Tall Linear Ready-to-Finish Kit*	RTF48TLDLP-K/ RTF48TLDNG-K	BI737DSILP/ BI737DSING	80,000	48"	36"	21"
60" x 36" Linear Ready-to-Finish Kit	RTF60LDNG-K***	BI737DSING	80,000	60"	36"	18"
72" x 36" Linear Ready-to-Finish Kit	RTF72LDNG-K***	BI757DSING	100,000	72"	36"	18"

Round Kits

NAME	SKU	BURNER INCLUDED	BTUs (LP/NG)	LENGTH	WIDTH	HEIGHT
MANUAL IGNITION (VCSV)**						
48" Round Ready-to-Finish Kit	RTF48C-K	BI28	105,000/ 106,000	48"	48"	18"
DIRECT SPARK IGNITION (DSI)**						
48" Round Ready-to-Finish Kit	RTF48CDNG-K***	BI28DSING	101,000/ 100,000	48"	48"	18"
60" Round Ready-to-Finish Kit	RTF60CDNG-K***	BI28DSING	101,000/ 100,000	60"	60"	18"

Square Kits

NAME	SKU	BURNER INCLUDED	BTUs (LP/NG)	LENGTH	WIDTH	HEIGHT
MANUAL IGNITION (VCSV)**						
48" x 48" Square Ready-to-Finish Kit	RTF48S-K	BI28	105,000/ 106,000	48"	48"	18"
DIRECT SPARK IGNITION (DSI)**						
48" x 48" Square Ready-to-Finish Kit	RTF48SDNG-K***	BI28DSING	101,000/ 100,000	48"	48"	18"
60" x 60" Square Ready-to-Finish Kit	RTF60SDNG-K***	BI28DSING	101,000/ 100,000	60"	60"	18"

*Fits 20 lb. liquid propane tank in base.

**See page 40 for more information on manual ignition and page 48 for electronic ignition.

***Liquid propane option available upon request.



Ready-to-Finish Fireplaces

Perfect for both commercial and residential applications!

We supply the structure, and you finish your masterpiece on-site to match your landscaping or exterior design. Ready-to-finish fireplaces are made from Hardiebacker® fiber cement boarding and G90 steel framing.



Finished Custom RSTL-60DNG



Finished RFLP-40MLP

- Made of G90 marine-grade galvanized steel framing and Hardiebacker® fiber cement boarding
- Fireplace opening enclosure is lined with #304 stainless steel
- Most models include direct spark ignition (DSI) — 40" model utilizes manual ignition (VCSV) and includes access door for standard 20 lb. propane tank
- Includes Crystal Fire® Plus burner insert, pre-installed vents, standard control panel, and glass wind guard panel(s)
- Other DSI controls, timers, e-stops, and fire media sold separately
- Can be used for liquid propane or natural gas installations — hard-pipe natural gas installation recommended
- **Custom sizing available** — contact OGC for more information.
- Made in USA

[See page 23 for fire media options and page 69 for custom form.](#)



RSTL-60DLP



RLFP-40DLP

See-Through Fireplaces

NAME	SKU	BURNER INCLUDED	BTUs	OVERALL DIMENSIONS			VIEWING AREA	
				LENGTH	WIDTH	HEIGHT	LENGTH	HEIGHT
MANUAL IGNITION (VCSV)*								
40" See-Through Ready-to-Finish Fireplace*	RSTL-40MLP	BI737	80,000	72"	18.5"	48"	40"	20"
DIRECT SPARK IGNITION (DSI)**								
40" See-Through Ready-to-Finish Fireplace	RSTL-40DLP/ RSTL-40DNG	BI737DSILP/ BI737DSING	80,000	72"	18.5"	48"	40"	20"
60" See-Through Ready-to-Finish Fireplace	RSTL-60DLP/ RSTL-60DNG	BI757DSILP/ BI757DSING	100,000	92"	18.5"	48"	60"	20"
72" See-Through Ready-to-Finish Fireplace	RSTL-72DLP/ RSTL-72DNG	BI766DSILP/ BI766DSING	100,000	108"	18.5"	48"	72"	20"

Single-Sided Fireplaces

NAME	SKU (LP/NG)	BURNER INCLUDED	BTUs	OVERALL DIMENSIONS			VIEWING AREA	
				LENGTH	WIDTH	HEIGHT	LENGTH	HEIGHT
MANUAL IGNITION (VCSV)*								
40" Single-Sided Ready-to-Finish Fireplace*	RLFP-40MLP	BI737	80,000	72"	18.5"	48"	40"	20"
DIRECT SPARK IGNITION (DSI)**								
40" Single-Sided Ready-to-Finish Fireplace	RLFP-40DLP/ RLFP-40DNG	BI737DSILP/ BI737DSING	80,000	72"	18.5"	48"	40"	20"
60" Single-Sided Ready-to-Finish Fireplace	RLFP-60DLP/ RLFP-60DNG	BI757DSILP/ BI757DSING	100,000	92"	18.5"	48"	60"	20"
72" Single-Sided Ready-to-Finish Fireplace	RLFP-72DLP/ RLFP-72DNG	BI766DSILP/ BI766DSING	100,000	108"	18.5"	48"	72"	20"

DSI Controls***



*Manual ignition control panel is mounted on lower front face of fireplace. Includes NG conversion kit and access door for LP storage.

**See page 40 for more information on manual ignition and page 48 for electronic ignition.

***See page 52 for more information on electronic ignition controls.



“We want our customers’ experience to be the best it can be, and that is why we exclusively sell fire tables from The Outdoor GreatRoom Company. We appreciate their high quality products and great service. They have been an excellent partner for us.”

—Brent from Energy Products and Design, customers since 2006



| ACCESSORIES



Accessories

Complete your outdoor fire feature with its own signature look! Our accessories provide a safe and durable compliment to your fire. Easily customize your table with a glass wind guard, glass media, cover, and more.



Amber
CFG-A

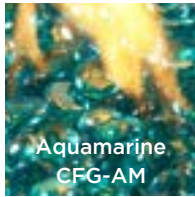

Aquamarine
CFG-AM

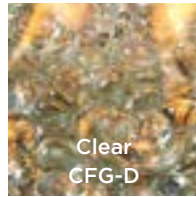

Clear
CFG-D

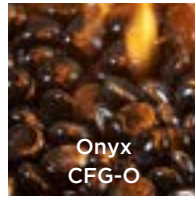

Onyx
CFG-O



Ruby
CFG-R



Black Diamonds
CFLD-B



Copper Diamonds
GFLD-C



Black Lava Rock
LAVA-BLK



Ceramic Log Set
CF20-LOG SET



Tumbled Lava Rock
LAV-TMB

Fire Media

Tempered fire glass lights up the fire pit table with an ember-like glow. Complete your gas fire pit table or outdoor fireplace with beautiful tempered glass gems or lava rock. Choose from many shapes, sizes, and colors to create a custom look — you can even mix and match!

- Find your favorite for a unique, custom look
- Seven glass media gems to choose from
- Black lava rock, tumbled lava rock, and ceramic log set favor a more natural look
- Realistic-looking ceramic log set includes six wood pieces
- Clear tempered glass gems (CFG-D) included with all fire pit tables

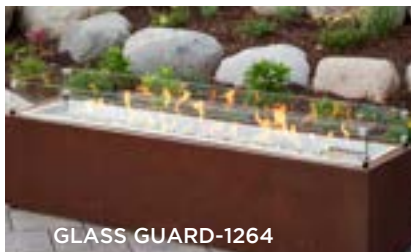

GLASS GUARD-1264

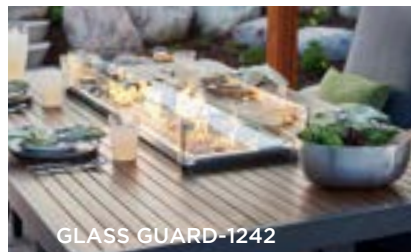

GLASS GUARD-1242

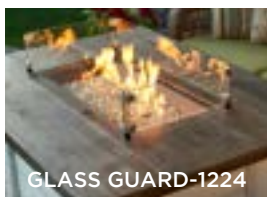

GLASS GUARD-1224



GLASS GUARD-20-R



GLASS GUARD-2424

Glass Wind Guards

Glass wind guards look beautiful with the reflection of the dancing flames. Glass guards are available to fit any standard Crystal Fire® Plus burner.

- Reduces wind effect and provides a safety barrier for children and animals
- Tempered glass panels
- Stainless steel hardware — round glass wind guards feature a stainless steel rod for added durability
- Easy to set up and clean

[See page 71 for custom glass wind guard form.](#)



FWG-1224 (up)



FWG-1224 (down)

Folding Wind Guards

The convenience of a glass wind guard and burner cover in one. Place the panels of glass up to protect the flame from the wind, and place them down to cover your burner when not in use. Available in two sizes: 12" x 24" (FWG-1224) and 12" x 42" (FWG-1242). Patent pending.

- Sits on top of burner trim
- Clear tempered glass
- Stainless steel hardware
- Easy to set up and clean

[See pages 62–65 for accessory glossary.](#)



1224-GREY-GLASS-COVER



20-R-GGC



Matching Supercast™ Cover



SS1242BC



CFT-GLASS

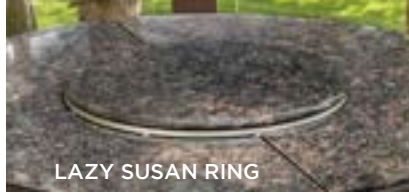

LAZY SUSAN RING

Burner Covers

Turn your beautiful fire pit into a functional table by covering the burner with one of our stylish burner covers. Covers also add an extra layer of protection from rain and debris when not in use.

- Grey glass burner covers are included with most fire pit tables; available for all burner sizes
- Select Supercast™ tables come with matching Supercast burner covers
- Add a stainless steel burner cover to CV-54, CV-72, or other select linear models
- Add a lazy susan ring or black glass cover to any of our 20" round burner covers

See page 71 for custom burner cover form.



CVR5132

Protective Covers

Protect your investment with protective covers from OGC! Protective covers are great for storing items long term or for everyday use.

- Available for most fire pit tables
- Tan polyester fabric stays cool to the touch
- Tear-resistant, rip-stop laminating
- Drawstring cord at bottom to secure to fire pit
- Polyester velvet interior protects finished material
- One-way breathability: exterior is water-resistant while being one-way breathable to let any interior moisture out



CV-54 with optional SS54T

Stainless Steel Trim

Compliment the unique look of the 54" and 72" Cove Linear tables (CV-54, CV-72) with this modern stainless steel top.

- Available in two sizes: 54" (SS54T) and 72" (SS72T)
- #304 commercial-grade stainless steel construction
- Adds layer of protection to concrete surface
- Easy to clean



BRON52-K with optional BRON52-CG-TC

Bronson Concrete Tops

Complete your Bronson round gas fire pit kit with an elegant, contemporary concrete top.

- Choose between two colors: Limestone Tan (BRON52-LT-TC) or Charcoal Grey (BRON52-CG-TC)
- Four pieces included with each SKU

Color options available

Limestone Tan
(BRON52-LT-TC)

Charcoal Grey
(BRON52-CG-TC)



“The Outdoor GreatRoom Company has been a great organization to work with over the years. Their exceptional customer service and durable, high-quality products leave strong impressions on the members of our team and the customers purchasing from us.”

—Mike from Keller Hearth’n Home, customers since 2006



OUTDOOR FURNITURE



Outdoor Furniture

Comfortable furniture makes any outdoor room complete!
Whether you have a modern or traditional backyard style, we've got just the right chair for you.
Choose between a variety of designs and sizes to find the perfect addition to your outdoor space.



LSR-CS

Lyndale Swivel Rocking Chairs

- Cast Slate or Cast Ash outdoor-rated Sunbrella® fabric
- Grey powder-coated aluminum frame
- Deep seating for added comfort
- Velcro® strap on back cushion to secure frame
- Set of 2

Color options available

Cast Slate
(LSR-CS)

Cast Ash
(LSR-CA)

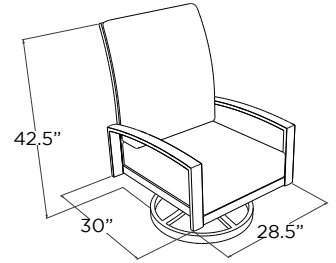

KW-LB and KW-SB

Kenwood Benches

- Umber brown composite decking
- Grey powder-coated aluminum frame
- Pair with Kenwood gas fire pit tables (KW-1224-19-K or KW-1242-K)
- Benches sold individually

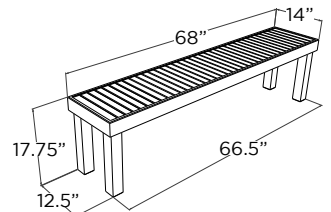
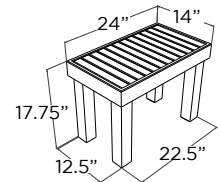

EMPIRE-BAR (table not included)

Empire Bar Stools

- Taupe outdoor-rated fabric with padded sling
- Dora brown powder-coated aluminum frame
- Perfect height for pub tables and outdoor kitchens
- Swivel bar stool
- Set of 2

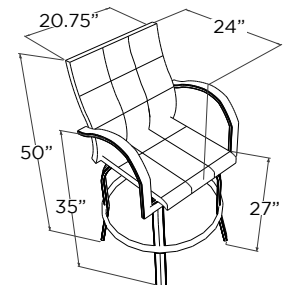



NAPLES-4030-L (table not included)

Naples Bar Stools

- Leather brown outdoor resin wicker
- Dora brown powder-coated aluminum frame
- Perfect height for pub tables and outdoor kitchens
- Swivel bar stool
- Set of 2

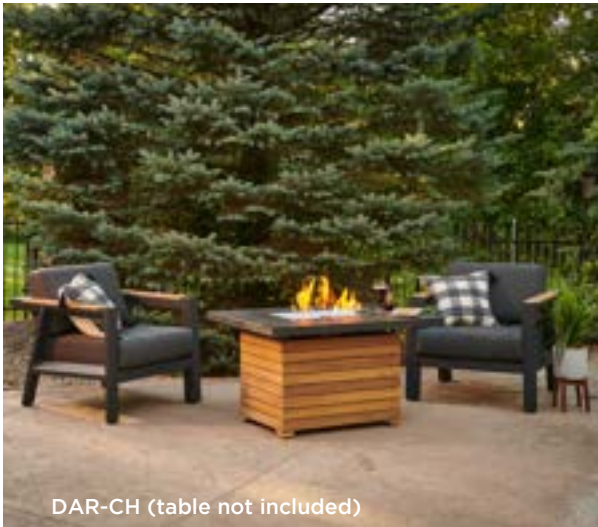
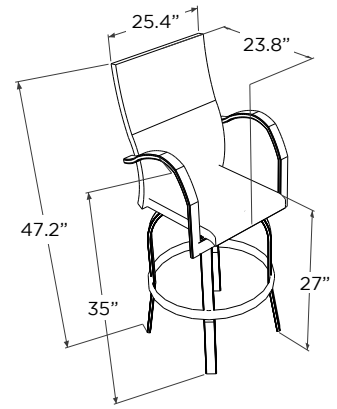

DAR-CH (table not included)

Darien Chairs

- Grey powder-coated aluminum frame with Grade A teak accents
- Cushions provide deep, comfy seating
- Grey outdoor-rated Olefin fabric
- Pair with Darien gas fire pit tables (DAR-1224-K or DAR-1224-EBG-K)
- Set of 2

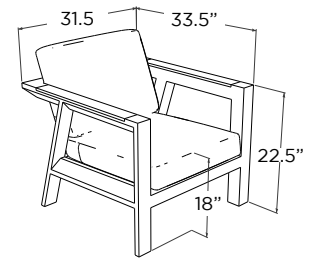

Complete your Outdoor Room.



Intrigue Outdoor Lantern

Turn your dining table into the wow factor of your backyard!
Our innovative, spinning Venturi flame provides instant ambiance for your outdoor space.
The Intrigue Outdoor Lantern is clean burning, easy to use, and fits any outdoor design.



INT-EZ

- Spinning Venturi flame designed to fit any table with an umbrella hole from 1.4"-4"
- Dora brown powder-coated finish
- Easy to assemble
- Single glass cylinder
- Use with 1 lb. propane tank
- For outdoor use only
- Includes black rubber glass lid
- Optional cover (CVRINT) sold separately
- UL and ULC listed

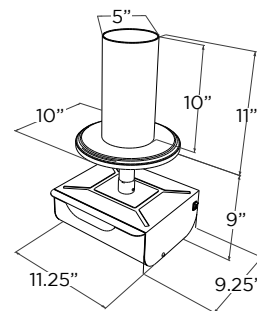



| CUSTOM CAPABILITIES



Custom Finishes

Create a masterpiece that's unique to your living area!
We help you along this exciting journey with our distinctive custom creation process.
Our materials and construction methods are designed to last. Actual finish colors may vary.



Midnight Mist and Black Fleck on KL-1242-MM



Washed Cedar on CR-1242-K



Marbleized Noche and Dora Brown on BC-20-MNB

Supercast™ Concrete

Deep Black	Midnight Mist	Natural Grey	Mocha	Sand
White	White Onyx	Marbleized Mocha	Marbleized Noche	Antique Timber
Tavern Brown	Washed Cedar	Weathered Barnwood		

Stucco

Black Fleck	Midnight Storm
Napa Valley	Ridge Brown
Serengeti	Stony Creek

Metal

Dora Brown	Graphite Grey
Luverne Black	Pewter Crater
White	

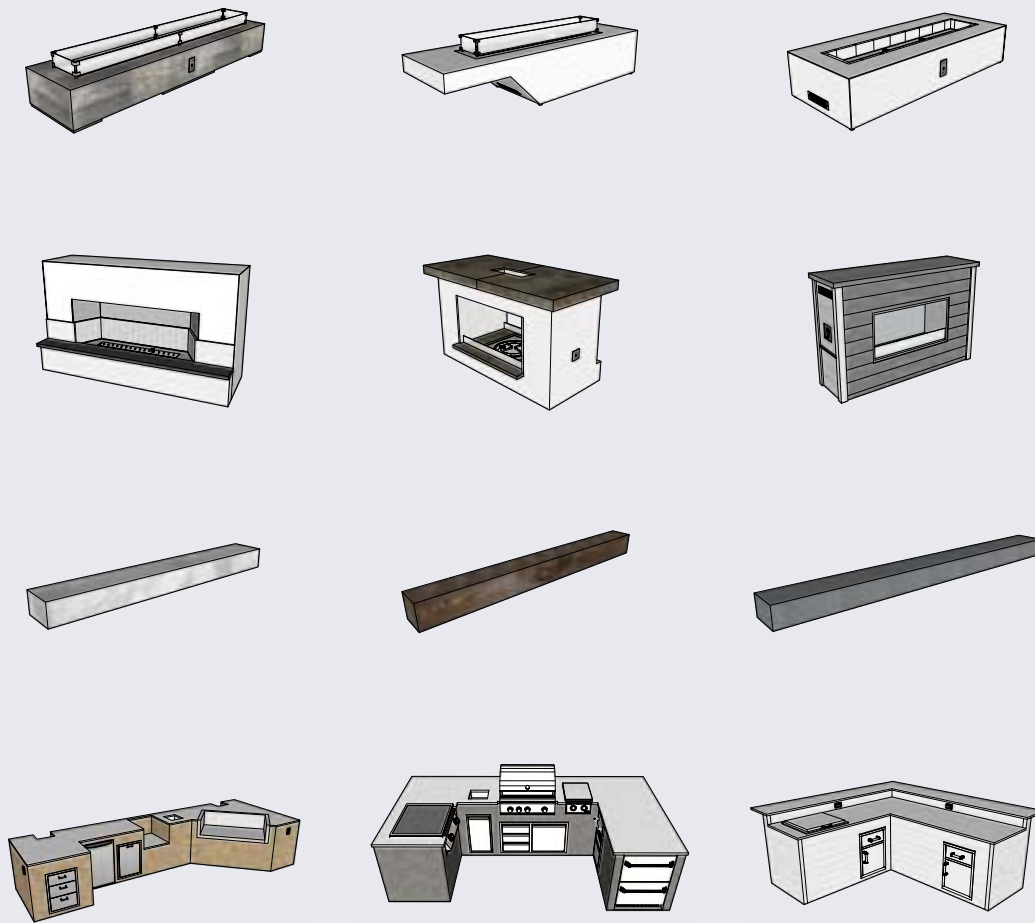

Our Custom Process

With our Minnesota-based customer service, design, engineering, and manufacturing abilities, we can help you design, build, and deliver the custom project you've been dreaming of. The process is simple and includes five steps to ensure we do everything correctly.

- 1 Start with something as basic as a sketch, desired dimensions, or material change to one of the many items in our catalog.
- 2 Use our custom request form and fill it out as completely as possible. See pages 67-71 for custom request forms.
- 3 The Outdoor GreatRoom Company (OGC) will provide an estimate for the project.
- 4 A custom rendering will be created (examples above) and submitted to you for approval.
- 5 Once everything is approved, a signed drawing and corresponding purchase order is submitted to OGC to start the creation process.



Custom Fire

Ignite your outdoor living area with a custom fire feature!
We'll work with you on making your dream design come to life.
Perfect for residential, commercial, or multi-family properties.



- Customize many of our standard fire pit tables or create your own unique gas fire pit or outdoor fireplace
- Common materials used are Supercast™ concrete, stucco, metal, tile, and stacked stone (see page 38 for available finishes.)
- Size and shape to fit your design
- Specify desired accessories, fuel type, and other notes in the custom form
- Other upgrades may include LED underlighting, custom glass guards, custom burner covers, and more
- UL and ULC listed Crystal Fire® Plus burners
- Made in USA

[See pages 67 and 69 for custom request forms.](#)



Custom Concrete Mantels

Stylize your living room area!

Compliment your already existing fireplace with a custom Supercast™ concrete mantel. Non-combustible mantels allow you to get as close as you'd like to those warm, beautiful flames.



Tavern brown finish on Weathered Barnwood grain

-
- Non-combustible Supercast concrete mantels
 - Two styles: traditional and modern
 - Choose between nine Supercast finishes (see page 38 for available finishes.)
 - Lengths up to 10' (minimum: 2')
 - Made in USA

See page 70 for custom request form.



Custom Outdoor Kitchens

Turn your outdoor dream into a practical reality!

Create your own custom outdoor kitchen and compliment it with your desired outdoor appliances. Choose between a variety of outdoor-rated materials or finish it on your own to match your exterior design.



-
- Custom kitchens utilize G90 marine grade galvanized steel framing with Hardiebacker® cement board sheeting
 - Common materials used are Supercast™ concrete, stucco, metal, tile, and stacked stone (see page 38 for available finishes.)
 - Customize your design to include a backsplash, elevated bar, Crystal Fire® Plus gas burner, storage, your favorite grills or other appliances, and more!
 - Made in USA

See [page 68](#) for custom request form.



21SNGL-V



28SNGL-H



25DAD/32DAD



32DDDC



30DRW1



16DRW2



16DRW3



30ICEINS



16PTH



20TRO



32DRYSTO



25ICEBIN



DAR044A5BSLDD



SINK

Optional Kitchen Accessories

NAME	SKU	LENGTH	WIDTH	HEIGHT
21" Vertical Single Access Door	21SNGL-V	17.25"	N/A	24.25"
Horizontal Single Access Door	28SNGL-H	24.25"	N/A	17.25"
25" Double Access Door	25DAD	21.38"	N/A	18.25"
32" Double Access Door	32DAD	28.38"	N/A	18.25"
32" Access Door and Double Drawer Combo	32DDDC	30.13"	21"	19.13"
30" Single Drawer	30DRW1	28.25"	21"	13.25"
16" Double Drawer	16DRW2	15.38"	21"	19.63"
16" Triple Drawer	16DRW3	15.38"	21"	27.63"
30" Roll Out Insulated Ice Drawer	30ICEINS	26.25"	21"	19.75"
16" Paper Towel Holder	16PTH	14.13"	8.63"	8.63"
20" Roll Out Trash or Propane Tank Drawer	20TRO	17.88"	16.38"	24.25"
32" Double Access Door Sealed Dry Storage	32DRYSTO	30.25"	21"	19.25"
25" Drop In Ice Bin Cooler with Condiment Tray	25ICEBIN	23.75"	23.75"	11.75"
Danby Refrigerator with Stainless Steel Door and Glass Shelves	DAR044A5BSLDD	21.25"	21"	33.5"
#304 Stainless Steel Sink with Single Faucet	SINK	14.5"	14.5"	6" below; 9" above

Custom Finishes Chart

Supercast™ Concrete

NAME	COVE FIRE PITS	FIRE TABLE TOP	KITCHEN TOP	MANTEL
Deep Black	X	X	X	X
Natural Grey	X	X	X	X
Midnight Mist	X	X	X	X
White	X	X	X	X
White Onyx		X	X	
Sand	X	X	X	X
Mocha	X	X	X	X
Marbleized Mocha		X	X	
Marbleized Noche		X	X	
Antique Timber	Request for quote.	X	X	
Tavern Brown	Request for quote.	X	X	X
Washed Cedar	Request for quote.	X	X	X
Weathered Barnwood	Request for quote.			X

Stucco

NAME	FIRE TABLE BASE	KITCHEN BASE
Black Fleck	X	X
Midnight Storm	X	X
Napa Valley	X	X
Ridge Brown	X	X
Serengeti	X	X
Stony Creek	X	X

Metal

NAME	FIRE TABLE BASE	KITCHEN BASE
Dora Brown	X	X
Graphite Grey	X	X
Luverne Black	X	X
Pewter Crater	X	X
White	X	X



Crystal Fire ^{PLUS} 

| BURNERS & KITS



Crystal Fire® Plus Burners

Patent pending burner technology to build the perfect fire!

Crystal Fire® Plus burners are included with every gas fire pit table sold by The Outdoor GreatRoom Company. Purchase separately for custom-built fire pits, fireplaces, or other outdoor installations.



Overmount Style

(burner shown: CFP1242-K with optional GLASS GUARD-1242)



Undermount Style

(burner shown: BP1264-A)



- Burners and burner kits include a variable control safety valve (VCSV), control panel, and clear tempered fire glass gems
- Higher BTU capacity for a brighter, taller, fuller, more yellow flame
- Safety ignition and safety shutdown operations
- “Positive connect” user experience with minimal gas connections for quick installation time
- #304 commercial-grade stainless steel construction
- Safe water drain system through perimeter of the pan
- Comes setup for connection to liquid propane but can be field-converted to natural gas
- Burners and kits above 72” in length include two valves and two control panels
- Installation should be completed by a certified gas technician
- Patent pending
- UL and ULC listed to ANSI Z.21.97-2017/CSA 2.41-2017 standard

[See page 47 for contract and commercial burner options.](#)



CFP1224-K



BP1236-A

Linear Burners (overmount style)

NAME	SKU	BTUs (LP/NG)	LENGTH	WIDTH	HEIGHT	MAXIMUM FIRE MEDIA
12" x 24" Crystal Fire® Plus Burner	CFP1224-K	55,000*	25.63"	13.5"	4.81"	10 lbs
12" x 42" Crystal Fire® Plus Burner	CFP1242-K	80,000*	42.6"	13.5"	4.81"	15 lbs
12" x 64" Crystal Fire® Plus Burner	CFP1264	100,000	64.3"	13.5"	4.81"	20 lbs
12" x 72" Crystal Fire® Plus Burner	CFP1272	125,000	72"	13.5"	4.81"	25 lbs
12" x 84" Crystal Fire® Plus Burner	CFP1284	140,000	84"	13.5"	4.81"	25 lbs
12" x 96" Crystal Fire® Plus Burner	CFP1296	165,000	96"	13.5"	4.81"	30 lbs
12" x 108" Crystal Fire® Plus Burner	CFP12108	180,000	108"	13.5"	4.81"	35 lbs
12" x 120" Crystal Fire® Plus Burner	CFP12120	200,000	120"	13.5"	4.81"	40 lbs

Linear Burner Insert and Plate Kits (undermount style)

NAME	SKU**	BTUs (LP/NG)	LENGTH	WIDTH	HEIGHT	MAXIMUM FIRE MEDIA
12" x 24" Crystal Fire® Plus Burner Insert and Plate Kit	BP1224-A	55,000*	25.63"	13.5"	4.29"	15 lbs
12" x 36" Crystal Fire® Plus Burner Insert and Plate Kit	BP1236-A	55,000*	36"	13.5"	4.29"	20 lbs
12" x 42" Crystal Fire® Plus Burner Insert and Plate Kit	BP1242-A	80,000*	42.6"	13.5"	4.29"	20 lbs
12" x 60" Crystal Fire® Plus Burner Insert and Plate Kit	BP1260-A	80,000*	60"	13.5"	4.29"	25 lbs
12" x 64" Crystal Fire® Plus Burner Insert and Plate Kit	BP1264-A	100,000	64.3"	13.5"	4.29"	25 lbs
12" x 72" Crystal Fire® Plus Burner Insert and Plate Kit	BP1272-A	125,000	72"	13.5"	4.29"	30 lbs
12" x 84" Crystal Fire® Plus Burner Insert and Plate Kit	BP1284-A	140,000	84"	13.5"	4.29"	30 lbs
12" x 96" Crystal Fire® Plus Burner Insert and Plate Kit	BP1296-A	165,000	96"	13.5"	4.29"	35 lbs
12" x 108" Crystal Fire® Plus Burner Insert and Plate Kit	BP12108-A	180,000	108"	13.5"	4.29"	40 lbs
12" x 120" Crystal Fire® Plus Burner Insert and Plate Kit	BP12120-A	200,000	120"	13.5"	4.29"	45 lbs

*Booster orifice available to increase BTU capacity if desired and approved for finishing structure. Glass wind guard required if booster orifice used with any OGC gas fire pit table.

**Burner plate kits include corresponding burner insert and burner plate. Burner insert can be purchased on its own if desired. Contact OGC for burner insert specifications.



Overmount Style
(burner shown: CFP20-K)



Undermount Style
(burner shown: BP30RD-A)

Round Burners (overmount style)

NAME	SKU	BTUs (LP/NG)	LENGTH	WIDTH	HEIGHT	FIRE MEDIA
20" Round Crystal Fire® Plus Burner	CFP20-K	55,000*	21.06"	21.06"	5.39"	10 lbs
30" Round Crystal Fire® Plus Burner	CFP30-K	105,000/ 106,000	32"	32"	5.39"	25 lbs

Round Burner Insert and Plate Kits (undermount style)

NAME	SKU**	BTUs (LP/NG)	LENGTH	WIDTH	HEIGHT	FIRE MEDIA
20" Round Crystal Fire® Plus Burner Insert and Plate Kit	BP20RD-A	55,000*	21.06"	21.06"	4.82"	15 lbs
24" Round Crystal Fire® Plus Burner Insert and Plate Kit	BP24RD-A	55,000*	24"	24"	4.82"	20 lbs
30" Round Crystal Fire® Plus Burner Insert and Plate Kit	BP30RD-A	105,000/ 106,000	32"	32"	4.82"	25 lbs
36" Round Crystal Fire® Plus Burner Insert and Plate Kit	BP36RD-A	105,000/ 106,000	36"	36"	4.82"	50 lbs
42" Round Crystal Fire® Plus Burner Insert and Plate Kit	BP42RD-A	105,000/ 106,000	42"	42"	4.82"	70 lbs
48" Round Crystal Fire® Plus Burner Insert and Plate Kit	BP48RD-A	105,000/ 106,000	48"	48"	4.82"	90 lbs

*Booster orifice available to increase BTU capacity if desired and approved for finishing structure. Glass wind guard required if booster orifice used with any OGC gas fire pit table.

**Burner plate kits include corresponding burner insert and burner plate. Burner insert can be purchased on its own if desired. Contact OGC for burner insert specifications.



CFP30-K



BP36RD-A



Square Burners (overmount style)

NAME	SKU	BTUs (LP/NG)	LENGTH	WIDTH	HEIGHT	FIRE MEDIA
24" x 24" Crystal Fire® Plus Burner	CFP2424-K	55,000*	25.75"	25.75"	4.63"	20 lbs

Square Burner Insert and Plate Kits (undermount style)

NAME	SKU**	BTUs (LP/NG)	LENGTH	WIDTH	HEIGHT	FIRE MEDIA
24" x 24" Crystal Fire® Plus Burner Insert and Plate Kit	BP24S-A	55,000*	24"	24"	4.2"	30 lbs
30" x 30" Crystal Fire® Plus Burner Insert and Plate Kit	BP30S-A	55,000*	30"	24"	4.2"	45 lbs
36" x 36" Crystal Fire® Plus Burner Insert and Plate Kit	BP36S-A	105,000/ 106,000	36"	36"	4.2"	65 lbs
42" x 42" Crystal Fire® Plus Burner Insert and Plate Kit	BP42S-A	105,000/ 106,000	42"	42"	4.2"	90 lbs

*Booster orifice available to increase BTU capacity if desired and approved for finishing structure. Glass wind guard required if booster orifice used with any OGC gas fire pit table.

**Burner plate kits include corresponding burner insert and burner plate. Burner insert can be purchased on its own if desired. Contact OGC for burner insert specifications.



CFP2424-K



BP36S-A

Controls



VCSV-CP



VCSV-DIY-CP

- If flame is not sensed for any reason, the flow of gas to the burner will safely shut down
- Adjustable flame operation
- Black powder-coated panel with black plastic knob and sparker
- For use with liquid propane or natural gas
- Optional gas key available
- Variable Control Safety Valve System (VCSV-CP) included with every standard table Crystal Fire® Plus burner and gas fire pit table (Dimensions: 6.375" H x 3.5" W)
- DIY control panel for use on custom or hardscape block applications (Dimensions: 9.5" L x 3" W x 4" H)
- Order DIY control panel for use with manual ignition (VCSV-DIY-CP) or direct spark ignition (DSI-DIY-CP)

Ventilation



VENT BLOCK BLACK



21005

- Crystal Fire® Plus burners require proper ventilation for any DIY or field-installed application
- Black ventilation block (VENT BLOCK BLACK) is made of black powder-coated stainless steel (Dimensions: 8.5" L x 4" W x 4" H)
- Ventilation plate (21005) is made of brushed stainless steel (Dimensions: 12" L x 3" W" x <1" H)

Get the complete kit with our Bronson Block collection.

The ultimate DIY project.

See pages 14 and 15 for more information.

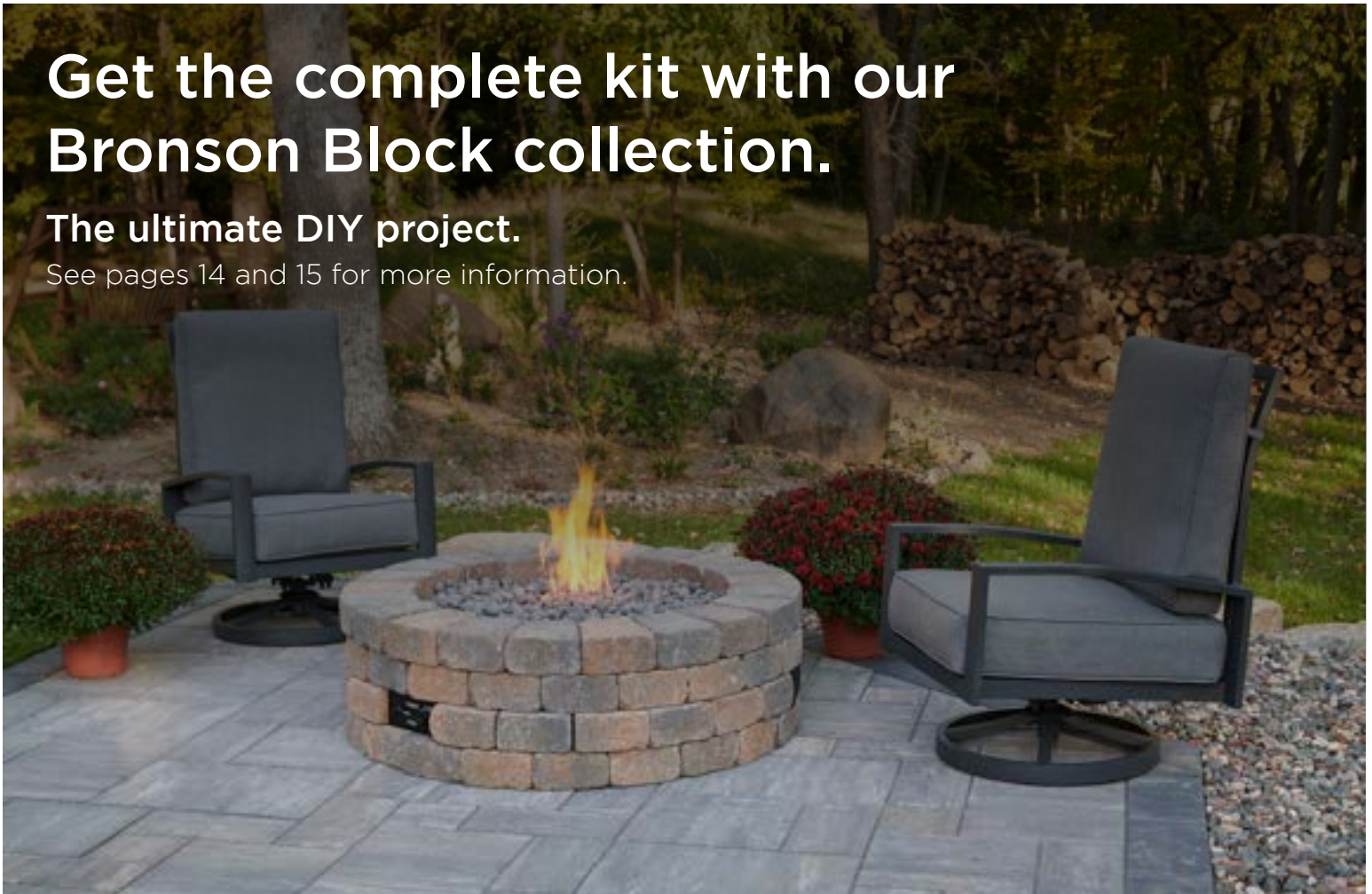



Do-it-Yourself Kits

Take the guesswork out of your do-it-yourself project with these convenient burner kits. Each kit includes everything you need for building the perfect fire pit. Just add brick pavers or other construction materials to make it your own!



VENT BLOCK BLACK



VCSV-DIY-CP



CFG-D



BP36RD-A

Specifications

NAME	SKU	BURNER INCLUDED	BTUs (LP/NG)	INCLUDED CLEAR GLASS GEMS
ROUND KITS				
24" Round Do-it-Yourself Crystal Fire® Plus Burner Kit	DIY-24RD-K	BP24RD-A	55,000	24 lbs
36" Round Do-it-Yourself Crystal Fire® Plus Burner Kit	DIY-36RD-K	BP36RD-A	105,000/106,000	36 lbs
42" Round Do-it-Yourself Crystal Fire® Plus Burner Kit	DIY-42RD-K	BP42RD-A	105,000/106,000	60 lbs
48" Round Do-it-Yourself Crystal Fire® Plus Burner Kit	DIY-48RD-K	BP48RD-A	105,000/106,000	96 lbs
SQUARE KITS				
24" x 24" Do-it-Yourself Crystal Fire® Plus Burner Kit	DIY-2424S-K	BP24S-A	55,000	24 lbs
30" x 30" Do-it-Yourself Crystal Fire® Plus Burner Kit	DIY-3030S-K	BP30S-A	55,000	36 lbs
36" x 36" Do-it-Yourself Crystal Fire® Plus Burner Kit	DIY-3636S-K	BP36S-A	105,000/106,000	48 lbs
42" x 42" Do-it-Yourself Crystal Fire® Plus Burner Kit	DIY-4242S-K	BP42S-A	105,000/106,000	96 lbs

- Build your own gas fire pit with a do-it-yourself gas fire pit kit
- Includes Crystal Fire® Plus burner insert, burner plate, control panel, two ventilation blocks, and clear tempered glass gems
- Choose between round or square shapes
- Paver blocks not included
- Made in USA



“The Outdoor Greatroom Company’s fire pits are an absolute show stopper and fit in well with any backyard design. Their customer service with us as a retailer is superb. They are always there to answer questions and provide support when we need it.”

—Harrison from *Imagine Backyard Living*, customers since 2015



PLUS
Crystal Fire 

| CONTRACT & COMMERCIAL



Contract and Commercial

Perfect for multi-family residences, hotels, sporting arenas, concert venues, restaurants, and more!
Any Outdoor GreatRoom Company product can be outfitted for contract and commercial spaces.

All commercial burners include a control panel, emergency stop button, clear glass gems and electronic ignition.

Overmount Styles



Undermount Styles



- Direct spark ignition (DSI) system with on/off switch operation
- Flame can be automatically ignited with a single control either on the fire pit or nearby surface
- If flame is not sensed for any reason, the flow of gas to the burner will safely shut down
- DSI system comes set up to run on 110V but can also be used on optional battery operation (CF-DSI-BP)
- Order specific for liquid propane or natural gas (not field-convertible)
- Includes red emergency stop button
- Optional timer, wall switch, Bluetooth® smart app, and other control panel configurations sold separately (see page 52 for control options)
- Ventilation required for field-installed burner enclosures
- Burners and kits above 72" in length include two valves and two control panels
- Installation should be completed by a certified gas technician
- Patent pending
- UL and ULC listed

See page 39 for manual ignition (VCSV) burners.



Burner with included components.



CFP1224DSILP
CFP1224DSING



BP1224DSILP-A
BP1224DSING-A

Linear Burners (overmount style)

NAME	SKU (LP/NG)	BTUs (LP/NG)	LENGTH	WIDTH	HEIGHT	MAXIMUM FIRE MEDIA
12" x 24" Crystal Fire® Plus Burner with DSI	CFP1224DSILP/ CFP1224DSING	55,000**	25.63"	13.5"	14.39"	10 lbs
12" x 42" Crystal Fire® Plus Burner with DSI	CFP1242DSILP/ CFP1242DSING	80,000**	42.6"	13.5"	14.38"	15 lbs
12" x 64" Crystal Fire® Plus Burner with DSI	CFP1264DSING*	100,000	64.3"	13.5"	14.38"	20 lbs
12" x 72" Crystal Fire® Plus Burner with DSI	CFP1272DSING*	100,000	72"	13.5"	14.38"	25 lbs
12" x 84" Crystal Fire® Plus Burner with DSI	CFP1284DSING*	120,000	84"	13.5"	14.38"	25 lbs
12" x 96" Crystal Fire® Plus Burner with DSI	CFP1296DSING*	130,000	96"	13.5"	14.38"	30 lbs
12" x 108" Crystal Fire® Plus Burner with DSI	CFP12108DSING*	140,000	108"	13.5"	14.38"	35 lbs
12" x 120" Crystal Fire® Plus Burner with DSI	CFP12120DSING*	140,000	120"	13.5"	14.38"	40 lbs

Linear Burner Insert and Plate Kits (undermount style)

NAME	SKU*** (LP/NG)	BTUs (LP/NG)	LENGTH	WIDTH	HEIGHT	MAXIMUM FIRE MEDIA
12" x 24" Crystal Fire® Plus Burner Insert and Plate Kit with DSI	BP1224DSILP-A/ BP1224DSING-A	55,000**	25.63"	13.5"	14.24"	15 lbs
12" x 36" Crystal Fire® Plus Burner Insert and Plate Kit with DSI	BP1236DSILP-A/ BP1236DSING-A	55,000**	36"	13.5"	14.24"	20 lbs
12" x 42" Crystal Fire® Plus Burner Insert and Plate Kit with DSI	BP1242DSILP-A/ BP1242DSING-A	80,000**	42.6"	13.5"	14.24"	20 lbs
12" x 60" Crystal Fire® Plus Burner Insert and Plate Kit with DSI	BP1260DSILP-A/ BP1260DSING-A	80,000**	60"	13.5"	14.24"	25 lbs
12" x 64" Crystal Fire® Plus Burner Insert and Plate Kit with DSI	BP1264DSING-A*	100,000	64.3"	13.5"	14.39"	25 lbs
12" x 72" Crystal Fire® Plus Burner Insert and Plate Kit with DSI	BP1272DSING-A*	100,000	72"	13.5"	14.26"	30 lbs
12" x 84" Crystal Fire® Plus Burner Insert and Plate Kit with DSI	BP1284DSING-A*	120,000	84"	13.5"	14.26"	30 lbs
12" x 96" Crystal Fire® Plus Burner Insert and Plate Kit with DSI	BP1296DSING-A*	130,000	96"	13.5"	14.26"	35 lbs
12" x 108" Crystal Fire® Plus Burner Insert and Plate Kit with DSI	BP12108DSING-A*	140,000	108"	13.5"	14.26"	40 lbs
12" x 120" Crystal Fire® Plus Burner Insert and Plate Kit with DSI	BP12120DSING-A*	140,000	120"	13.5"	14.26"	45 lbs

*Liquid propane option available upon request.

**Booster orifice available to increase BTU capacity if desired and approved for finishing structure. Glass wind guard required if booster orifice used with any OGC gas fire pit table.

***Burner plate kits include corresponding burner insert and burner plate. Burner insert can be purchased on its own if desired. Contact OGC for burner insert specifications.

Add some flare to your space.

Round Burners (overmount style)

NAME	SKU (LP/NG)	BTUs (LP/NG)	LENGTH	WIDTH	HEIGHT	MAXIMUM FIRE MEDIA
20" Round Crystal Fire® Plus Burner with DSI	CFP20DSILP/ CFP20DSING	55,000*	21.06"	21.06"	11.71"	10 lbs
30" Round Crystal Fire® Plus Burner with DSI	CFP30DSILP/ CFP30DSING	101,000/ 100,000	32"	32"	11.2"	25 lbs

Round Burner Insert and Plate Kits (undermount style)

NAME	SKU** (LP/NG)	BTUs (LP/NG)	LENGTH	WIDTH	HEIGHT	MAXIMUM FIRE MEDIA
20" Round Crystal Fire® Plus Burner Insert & Plate Kit with DSI	BP20RDDSILP-A/ BP20RDDSING-A	55,000*	21.06 "	21.06 "	15.3"	15 lbs
24" Round Crystal Fire® Plus Burner Insert & Plate Kit with DSI	BP24RDDSILP-A/ BP24RDDSING-A	55,000*	24"	24"	15.3"	20 lbs
30" Round Crystal Fire® Plus Burner Insert & Plate Kit with DSI	BP30RDDSILP-A/ BP30RDDSING-A	101,000/ 100,000	32"	32"	14.61"	25 lbs
36" Round Crystal Fire® Plus Burner Insert & Plate Kit with DSI	BP36RDDSILP-A/ BP36RDDSING-A	101,000/ 100,000	36"	36"	14.61"	50 lbs
42" Round Crystal Fire® Plus Burner Insert & Plate Kit with DSI	BP42RDDSILP-A/ BP42RDDSING-A	101,000/ 100,000	42"	42"	14.61"	70 lbs
48" Round Crystal Fire® Plus Burner Insert & Plate Kit with DSI	BP48RDDSILP-A/ BP48RDDSING-A	101,000/ 100,000	48"	48"	14.61"	90 lbs

*Booster orifice available to increase BTU capacity if desired and approved for finishing structure. Glass wind guard required if booster orifice used with any OGC gas fire pit table.

**Burner plate kits include corresponding burner insert and burner plate. Burner insert can be purchased on its own if desired. Contact OGC for burner insert specifications.



CFP30DSILP
CFP30DSING



BP36RDDSILP-A
BP36RDDSING-A

CFP2424DSILP
CFP2424DSING



BP36SDSILP-A
BP36SDSING-A



Square Burners (overmount style)

NAME	SKU (LP/NG)	BTUs (LP/NG)	LENGTH	WIDTH	HEIGHT	MAXIMUM FIRE MEDIA
24" x 24" Crystal Fire® Plus Burner with DSI	CFP2424DSILP/ CFP2424DSING	55,000*	25.75"	25.75"	14.71"	20 lbs

Square Burner Insert and Plate Kits (undermount style)

NAME	SKU** (LP/NG)	BTUs (LP/NG)	LENGTH	WIDTH	HEIGHT	MAXIMUM FIRE MEDIA
24" x 24" Crystal Fire® Plus Burner Insert & Plate Kit with DSI	BP24SDSILP-A/ BP24SDSING-A	55,000*	24"	24"	14.66"	30 lbs
30" x 30" Crystal Fire® Plus Burner Insert & Plate Kit with DSI	BP30SDSILP-A/ BP30SDSING-A	55,000*	30"	30"	14.66"	45 lbs
36" x 36" Crystal Fire® Plus Burner Insert & Plate Kit with DSI	BP36SDSILP-A/ BP36SDSING-A	101,000/ 100,000	36"	36"	14.66"	65 lbs
42" x 42" Crystal Fire® Plus Burner Insert & Plate Kit with DSI	BP42SDSILP-A/ BP42SDSING-A	101,000/ 100,000	42"	42"	14.66"	90 lbs

*Booster orifice available to increase BTU capacity if desired and approved for finishing structure. Glass wind guard required if booster orifice used with any OGC gas fire pit table.

**Burner plate kits include corresponding burner insert and burner plate. Burner insert can be purchased on its own if desired. Contact OGC for burner insert specifications.

Factors to consider when selecting your burner:

- 1 **Installation Site:** Is your burner going into an already built surround or will you need a fire table or ready-to-finish base for your burner?
- 2 **Burner Mount:** Whether you are looking for a top overmount or bottom undermount application, we have the burner for you. Choose from drop in burners or burner insert and plate kits.
- 3 **Installation Opening:** What size and shape is your installation opening? Choose from our stocked burners or burner insert and plate kits to fit your space. If a stocked option is not available, ask about our custom options.
- 4 **Operation and Controls:** Do you want controls available for public use or in a more secure, controlled setting? Choose controls, such as a timer, Bluetooth® application, or on/off switch for your application.

Timers



4HRTC



CF-DSI-60MT

- Available in 1-hour and 4-hour options
- Timer replaces controls for direct spark ignition system
- Timer is built into control panel
- Switch bypass (CF-DSI-SB) included with burner for safe and controlled user operation
- Black powder-coated panel with white timer dial
- Dimensions: 6.375" L x 3.5" W

Emergency Stop Button



CFP-ESO-CP



- Immediately shuts off flame when pressed
- Red button included with direct spark ignition system
- Switch bypass (CF-DSI-SB) included with burner for safe and controlled user operation
- Black powder-coated panel with red plastic emergency stop button
- Dimensions: 4.5" L x 2.625" W

On/Off Switch with Emergency Stop Button



WSEP-CP



- On/Off wall switch with emergency stop button
- Replaces controls for direct spark ignition system
- For applications away from the appliance
- Switch bypass (CF-DSI-SB) included with burner for safe and controlled user operation
- Black powder-coated panel with black switch
- Dimensions: 4.5" L x 4.525" W

Timer with Emergency Stop Button



4HRTES-CP



- Four-hour timer with emergency stop button
- Replaces controls for direct spark ignition system
- For applications away from the appliance
- Switch bypass (CF-DSI-SB) included with burner for safe and controlled user operation
- Black powder-coated panel with white timer dial
- Dimensions: 4.5" L x 4.625" W

Bluetooth® Smart App

- Ignite your fire pit or fireplace from your smart device
- Convenient timer automatically turns off the fire
- User-friendly application offers easy installation and syncing process
- Syncs over Bluetooth®
- Available for use with all direct spark ignition systems
- Compatible with iOS™ and Android™
- For residential use only



DSI-SA





Black Wave Gas Burner

Modern meets innovation with this unique burner design!
The Wave can be installed in custom-built gas fire pits, fireplaces, or other outdoor projects.
The three-tubed burner is made from high-quality, black powder-coated stainless steel.



WV-56-LP
WV-56-NG

- Black powder-coated #304 stainless steel
- 54" three-tube burner with black onyx tempered fire glass gems - 150,000 BTUs (LP/NG)
- Includes burner, glass wind guard, ignition system, and glass gems
- Choose between liquid propane (WV-56-LP) or natural gas (WV-56-NG)
- Comes standard with direct spark ignition (DSI)
- UL listed
- Made in USA

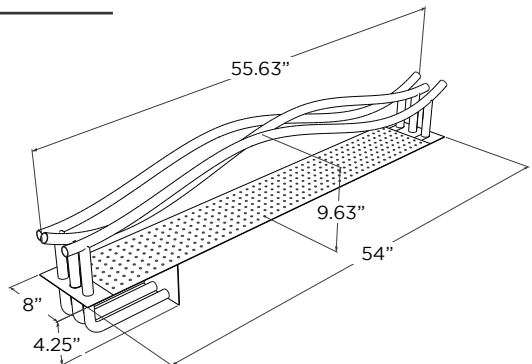



“While OGC’s products impress customers, their customer service, business values, and commitment to their retailers impress us the most.”

—Panatda from *The Wickery*, customers since 2016



INDOOR LIVING



Non-Combustible Mantels

Compliment your gas or electric fireplace with a non-combustible Supercast™ concrete mantel! Supercast concrete is the perfect material for a sturdy, reliable mantel for indoors or outdoors. Mantels are a great spot for displaying décor and adding that extra cozy, personal touch to your fireplace.



GWMT-60

-
- Constructed of non-combustible Supercast concrete
 - Six standard finishes: Midnight Mist, Natural Grey, White, Washed Cedar, Weathered Barnwood, and Tavern Brown
 - Reduced clearances
 - Real wood-look appearance
 - Choose between lengths of 60" or 72"
 - Custom lengths available
 - Easy installation and easy to clean
 - For indoor and outdoor applications
 - Made in USA
- See page 35 for custom mantel capabilities and 70 for custom mantel form.

Midnight Mist



Natural Grey



White



Washed Cedar



Weathered Barnwood



Tavern Brown



Specifications

NAME	SKU	FINISH	OVERALL DIMENSIONS			WEIGHT
			LENGTH	WIDTH	HEIGHT	
MODERN STYLE						
Midnight Mist Non-Combustible Mantel (60", 72")	GMMMT-60 GMMMT-72	Polished	60" 72"	8"	5"	90 lbs 104 lbs
Natural Grey Non-Combustible Mantel (60", 72")	GCVMT-60 GCVMT-72	Polished	60" 72"	8"	5"	90 lbs 104 lbs
White Non-Combustible Mantel (60", 72")	GWM-60 GWM-72	Polished	60" 72"	8"	5"	90 lbs 104 lbs
TRADITIONAL STYLE						
Washed Cedar Non-Combustible Mantel (60", 72")	GWCT-60 GWCT-72	Woodgrain	60" 72"	8"	8"	150 lbs 180 lbs
Weathered Barnwood Non-Combustible Mantel (60", 72")	GWBM-60 GWBM-72	Woodgrain	60" 72"	6.375"	7.25"	150 lbs 180 lbs
Tavern Brown Non-Combustible Mantel (60", 72")	GWMT-60 GWMT-72	Woodgrain	60" 72"	8"	8"	150 lbs 180 lbs



Electric Fireplace Inserts

Modernize the focal point of your indoor living area!
 Turn any traditional fireplace into an easy-to-use, clean, and efficient electric fireplace in minutes.
 Take measurements to determine which insert would fit best in your space.



GI-29 with optional IS-36

29" Electric Insert

- Can be used with existing wood fireplace opening, custom-built cabinet, or recessed wall
- Firebox only — purchase optional surround to fill gap between opening and insert
- Realistic-looking fire, logs, ember bed, and faux brick background
- Two-speed heater fan
- Tempered glass front
- Includes remote for adjusting flame, backlighting, ember bed, and fan for heat
- CSA tested and approved for safety

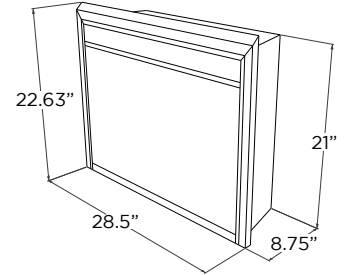

Optional surrounds available

NAME	SKU	OVERALL DIMENSIONS		
		LENGTH	WIDTH	HEIGHT
INSERT SURROUND				
36" Insert Surround	IS-36	36.25"	0.75"	27"
42" Insert Surround	IS-42	42.25"	0.75"	29"



GI-32-ZC with optional IS-36-ZC

32" Zero Clearance Electric Insert

- Designed to be used with existing wood fireplace opening with top or bottom grills; can also be used with a custom-built cabinet or recessed wall
- Firebox only — purchase optional insert and bottom surround to fill gap between opening and insert
- Realistic-looking fire, logs, ember bed, and faux brick background
- Two-speed heater fan
- Tempered glass front
- Includes remote for adjusting flame, backlighting, ember bed, and fan for heat
- CSA tested and approved for safety

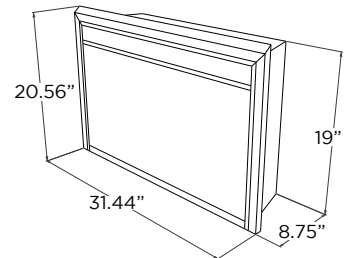

Optional surrounds available

NAME	SKU	OVERALL DIMENSIONS		
		LENGTH	WIDTH	HEIGHT
INSERT SURROUND				
36" Insert Surround	IS-36-ZC	36.25"	1"	27"
42" Insert Surround	IS-42-ZC	42.25"	1"	28.5"
BOTTOM SURROUND				
36" Bottom Surround	IS-36-ZC-B	36.25"	1"	4"
42" Bottom Surround	IS-42-ZC-B	42.25"	1"	4"

Before



After



Transform your living room.



“We have been offering industry leading Outdoor GreatRoom Company products for years. Customers love the quality, fit and finish, and dependable service. The Outdoor GreatRoom Company has it all!”

—Dean from Dean’s Stove & Spa, customers since 2011



REFERENCES

Accessory Glossary

Rectangular Accessories



Glass Wind Guard

● GLASS GUARD-1224

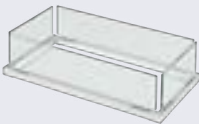

Folding Wind Guard

● FWG-1224



Grey Glass Cover

● 1224-GREY-GLASS-COVER



Protective Cover

■ SKU listed with product.



ALC-1224

● ● ●

■ CVR5038



KW-1224-19-K

● ● ●

■ CVR5132



BRK-1224-19-K

● ● ●

■ CVR5132



KN-1224

● ● ●

■ CVR275715



PROV-1224-SS

● ● ●

■ CVR3727



DAR-1224-EBG-K

● ● ●

■ CVR4634



DAR-1224-K

● ● ●

■ CVR4634



HVDG-1224-K

● ● ●

■ CVR4634



HVGW-1224-K

● ● ●

■ CVR4634



HVDG-1224-K

● ● ●

■ CVR4634



HVDW-1224-K

● ● ●

■ CVR4634

Customize your look.

Learn more about accessories on page 23.



MG-1242-BLSM-K



CVR6332



UPT-1242



CVR6549



UPT-1242-BRN



CVR6549



CR-1242-K



CVR6332



DENBR-1242



CVR6332



KL-1242-MM



CVR5427



KL-1242-SS



CVR5020



KW-1242-K



CVR8355



MCR-1242-BLK-K



CVR6332



CV-54



CVR275715



CV-72



CV-54WT



CVR275715



CV-72WT



CV-54MM



CVR275715



CV-72MM



Linear Accessories



Glass Wind Guard

GLASS GUARD-1242

GLASS GUARD-1264

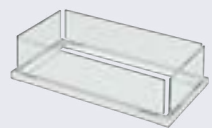

Folding Wind Guard

FWG-1242

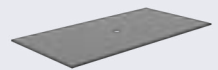

Grey Glass Cover

1242-GREY-GLASS-COVER



Stainless Steel Cover

SS1242BC

SS1264BC



Protective Cover

SKU listed with product.

Round Accessories



Glass Wind Guard

- GLASS GUARD-20-R
- GLASS GUARD-30-R



Grey Glass Cover

- 20-R-GGC
- 30-R-GGC



Ceramic Log Set

- CF20-LOG SET



Black Glass Cover

- CFT-GLASS



Lazy Susan Ring

- LAZY SUSAN RING



Protective Cover

- SKU listed with product.



SF-32-K

-
- CVR36



SF-32-GRY-K

-
- CVR36



ED-20

-
- CVR42



BC-20-MNB

-
- CVR50



BC-20-WO

-
- CVR50



BRON52-K

-
- CVR55



CV-20

-
- CVR36



CV-30WT

-
- CVR42



CV-30MM

-
- CVR42



CV-30

-
- CVR42



CV-30EMM

-
- CVR42



CV-30EWHT

-
- CVR42



CV-30E

-
- CVR42



BRON5151-K



CV-2424



CVR3939



SIERRA-2424-M-K



CVR4444

Square Accessories



Glass Wind Guard

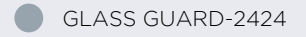

GLASS GUARD-2424

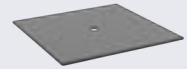

Grey Glass Cover

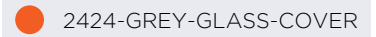

2424-GREY-GLASS-COVER



Ceramic Log Set

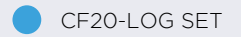

CF20-LOG SET



Protective Cover

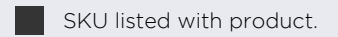

SKU listed with product.

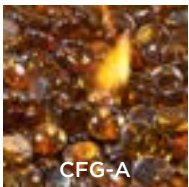

CFG-A

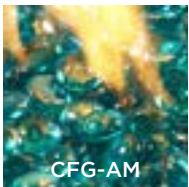

CFG-AM

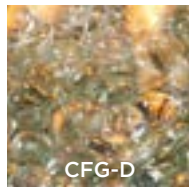

CFG-D

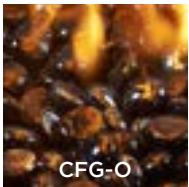

CFG-O

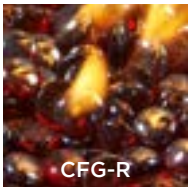

CFG-R



CFLD-B

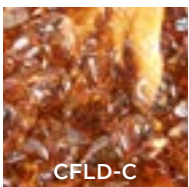

CFLD-C



LAVA-BLK



LAV-TMB



Finish your fire.

Standard Materials



Tempered Glass

Tempered glass is used for all glass wind guards, burner covers, and fire glass. It has been heat-treated and is safe to use with our Crystal Fire® Plus burners. Untempered glass or glass that has not been heat-treated can explode when it reaches high temperatures and is not safe to use with gas fire pit tables.



Stucco

Stucco is used on many of our outdoor products and comes in many colors and finishes. Stucco is a low-maintenance and durable outdoor finish.



Supercast™ Concrete

Supercast is a proprietary blend of fiberglass and concrete to provide durability and strength. It is stronger and weighs less than traditional concrete. We have a variety of standard colors and finish looks. Custom options available.



Everblend™ Concrete

Everblend is a process and material developed in-house and manufactured exclusively at The Outdoor GreatRoom Company. It is a weatherproof, concrete finish over a fiber cement and steel structure. The durability can be compared to any glass fiber reinforced concrete but is lighterweight for easier handling and installation.



Wood

Appearance-grade, high-quality wood is used to create your dream design. Multiple stain options are available. Use wood to accent your look or complete your entire design.



Stainless Steel

Crystal Fire® Plus burners, outdoor kitchen accessories, and finish trims are made from #304 stainless steel. #304 stainless steel is a high quality, commercial-grade metal.



Steel Framing

Steel framing is used to build many of our gas fire pit tables, outdoor fireplaces, and custom outdoor kitchens. The framing is commercial-grade G90 marine grade galvanized stainless steel that is resistant to all rust and corrosion.

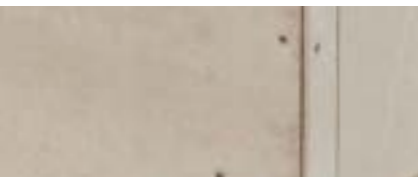

Hardiebacker®

Hardiebacker fiber cement boarding is used to build many of our fire pit tables, outdoor fireplaces, and custom outdoor kitchens. The board is non-combustible and resistant to mold and mildew, making it ideal for outdoor applications.



Rip-Stop Polyester

Polyester is used for all of the tan protective covers. The fabric provides one-way breathability: keeping exterior water away yet allowing interior moisture out. The covers feature tear-resistant, rip-stop laminating to further reinforce its strength and protection for the outdoors.

CUSTOM GAS FIRE PIT TABLE **REQUEST FORM**

Customer Name _____ Dealer Name _____ Date _____

Edge Style

Flat Chiseled Bull nose

Special Notes

Please provide or attach a drawing of your custom request, including all dimensions (L x W x H).

Material Options

Finish on your own (Hardiebacker® cement boarding and steel framing)

Top Material | **Supercast™ Concrete**

Smooth

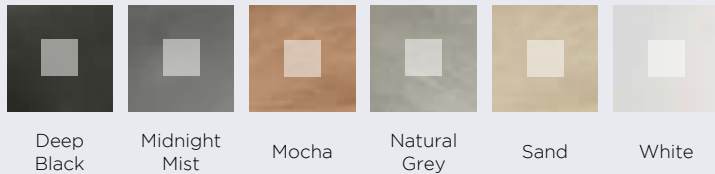

Marbleized

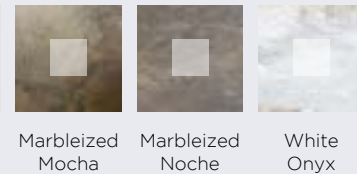

Wood Grain

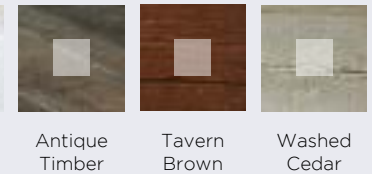

Base Material | **Stucco**

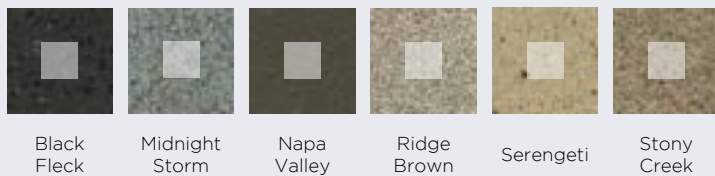

Metal

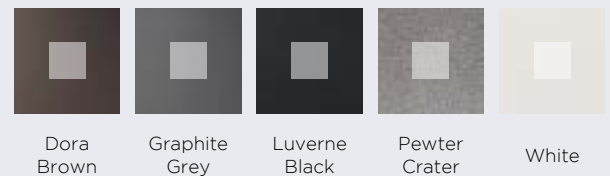

Burner Options

Shape | **Linear**

- CFP1224-K
- CFP1242-K
- CFP1264
- CFP1272
- CFP1284
- CFP1296
- CFP12108
- CFP12120
- BP1224-A
- BP1236-A
- BP1242-A
- BP1260-A
- BP1264-A
- BP1272-A
- BP1284-A
- BP1296-A
- BP12108-A
- BP12120-A

| **Square**

- CFP2424-K
- BP24S-A
- BP30S-A
- BP36S-A
- BP42S-A

| **Round**

- CFP20-K
- CFP30-K
- BP20RD-A
- BP24RD-A
- BP30RD-A
- BP36RD-A
- BP42RD-A
- BP48RD-A

| **Custom**

Custom length or shape (Specify: _____)

Ignition System

- Manual ignition (VCSV)
- Direct spark ignition (DSI)

Fuel Type

- Natural gas
- Liquid propane (Specify hard-pipe or tank: _____)
- LP tank access door

Accessories

- Glass guard
- Glass cover
- Supercast cover
- Stainless steel cover

Submit completed form to sales@outdoorrooms.com.

CUSTOM OUTDOOR KITCHEN REQUEST FORM

Customer Name _____ Dealer Name _____ Date _____

Edge Style

Flat Chiseled Bull nose

Special Notes

Please provide a drawing of your custom request, including all dimensions & accessories (L x W x H).

Outdoor Kitchen Style

Flat counter Backsplash (no back bar) Countertop overhang (_____ ") Elevated back bar (standard 12" overhang)

Material Options

Finish on your own (Hardiebacker® cement boarding and steel framing)

Top Material | Supercast™ Concrete

Smooth



Deep Black

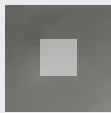

Midnight Mist

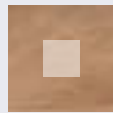

Mocha

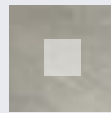

Natural Grey



Sand

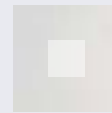

White

Marbleized

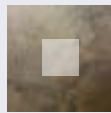

Marbleized Mocha

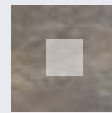

Marbleized Noche

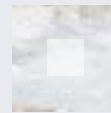

White Onyx

Wood Grain

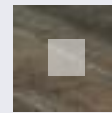

Antique Timber

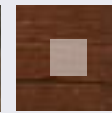

Tavern Brown

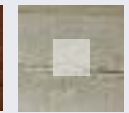

Washed Cedar

Base Material | Stucco



Black Fleck



Midnight Storm



Napa Valley



Ridge Brown



Serengeti

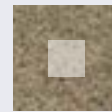

Stony Creek

Metal

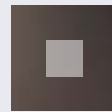

Dora Brown

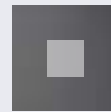

Graphite Grey

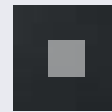

Luverne Black

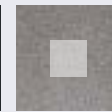

Pewter Crater



White

Accessory Options

Storage

16DRW2 21SINGL-V
 16DRW3 25ICEBIN
 30DRW1 28SINGL-H
 32DDDC 20TRO
 30ICEINS DAR044A5BSLDD
 32DRYSTO 25DAD 32DAD

Additional Features

Grill (Brand: _____, Model: _____, Cut-out dimensions: _____)
 Crystal Fire® Plus burner (SKU: _____)
 Sink Umbrella hole Paper tower holder Outlets(s) (Qty: _____)
 Hardiebacker island floor Enclose accessory cutouts with Hardiebacker
 Other (Specify: _____)

Submit completed form to sales@outdoorrooms.com.

CUSTOM OUTDOOR FIREPLACE REQUEST FORM

Customer Name _____ Dealer Name _____ Date _____

Specifications

Finish on site — structure constructed of outdoor-rated cement boarding and steel framing.

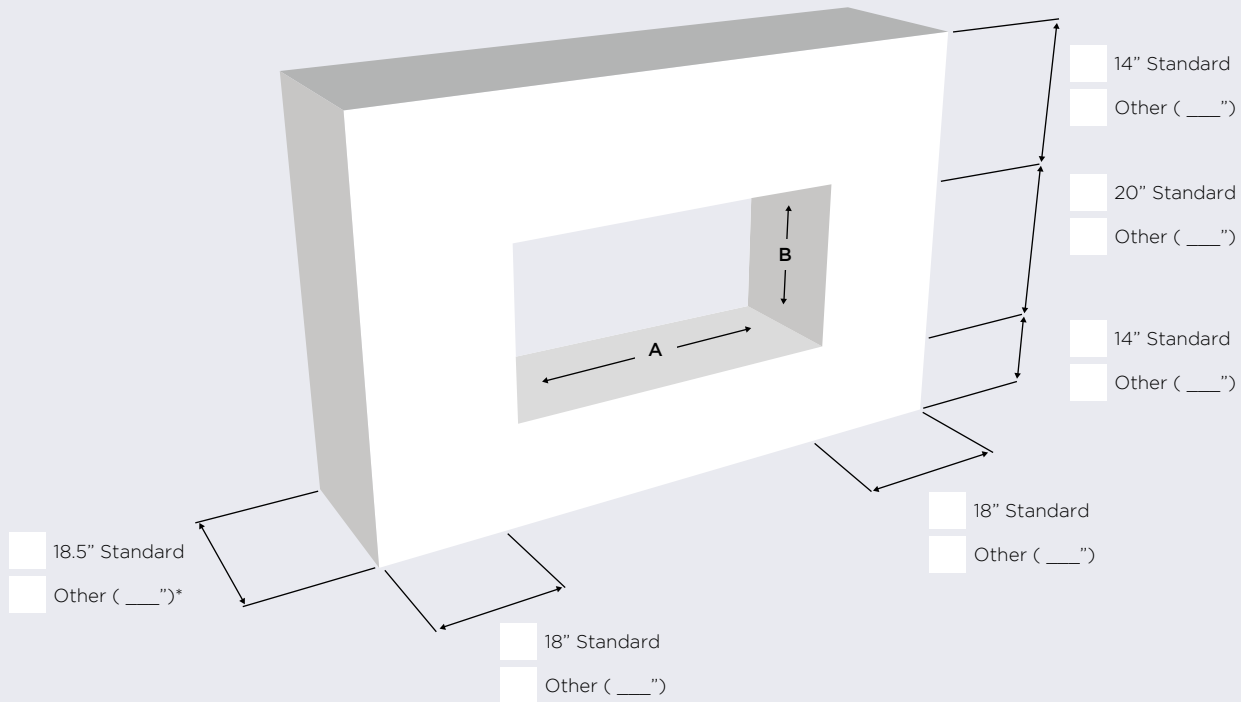

Firebox Opening (A x B)*

- | | | | |
|--|---|---|---|
| <input type="checkbox"/> 40" L x 20" H | <input type="checkbox"/> 60" L x 20" H | <input type="checkbox"/> 72" L x 20" H | <input type="checkbox"/> 84" L x 20" H |
| <input type="checkbox"/> 96" L x 20" H | <input type="checkbox"/> 108" L x 20" H | <input type="checkbox"/> 120" L x 20" H | <input type="checkbox"/> Other (___" L x ___" H) |

Style

- See-through
- Single-sided

Fuel Type

- Liquid propane
- Natural gas

Ignition System

- Manual ignition (VCSV)
- Direct spark ignition (DSI)

Fire Media

- LAV-TMB
- LAVA-BLK
- CFG-D
- CFG-O
- CFG-R
- CFG-A
- CFG-AM
- CFLD-B
- CFLD-C

Special Notes

*Selecting standard dimensions (when applicable) will provide the most cost-effective approach for custom project.

Submit completed form to sales@outdoorrooms.com.

CUSTOM CONCRETE MANTEL REQUEST FORM

Customer Name _____ Dealer Name _____ Date _____

Traditional Style Mantel

Height and depth are not customizable.

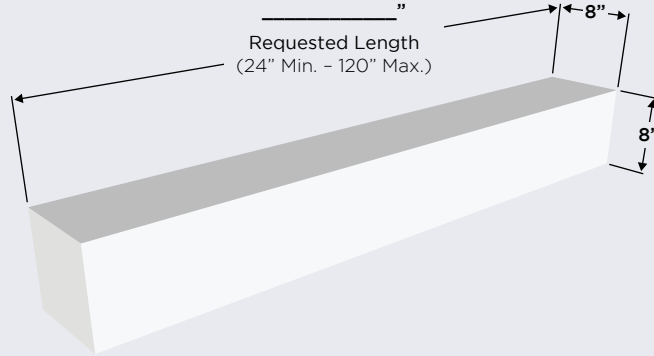

Supecast™ Choices

Smooth					Wood Grain			
Deep Black	Midnight Mist	Mocha	Natural Grey	Sand	White	Tavern Brown	Washed Cedar	Weathered Barnwood
<input type="checkbox"/> Other (Specify: _____)								

Modern Style Mantel

Height and depth are not customizable.

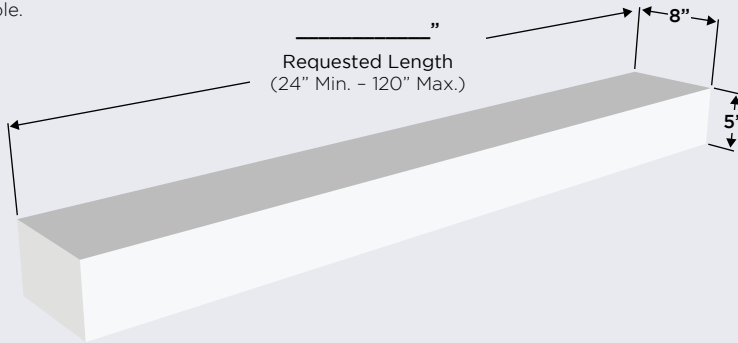

Supecast™ Choices

Smooth					
Deep Black	Midnight Mist	Mocha	Natural Grey	Sand	White
<input type="checkbox"/> Other (Specify: _____)					

Submit completed form to sales@outdoorrooms.com.

CUSTOM ACCESSORIES REQUEST FORM

Customer Name _____ Dealer Name _____ Date _____

Glass Wind Guard

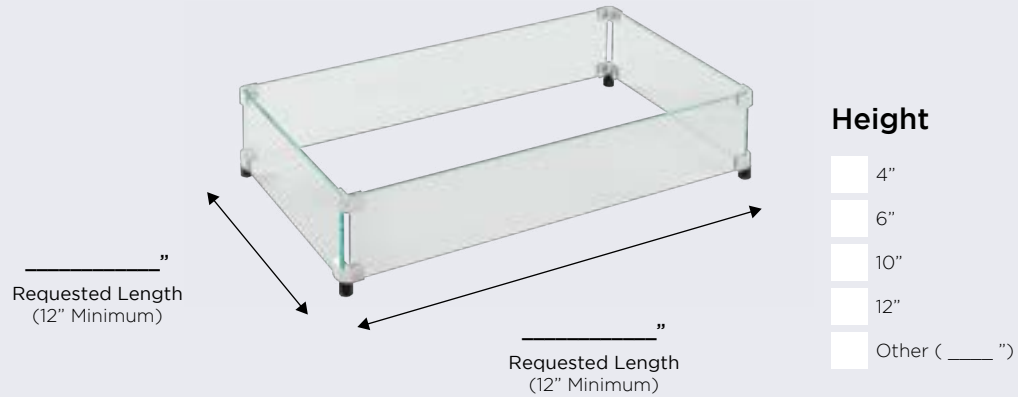

Tempered Glass Cover

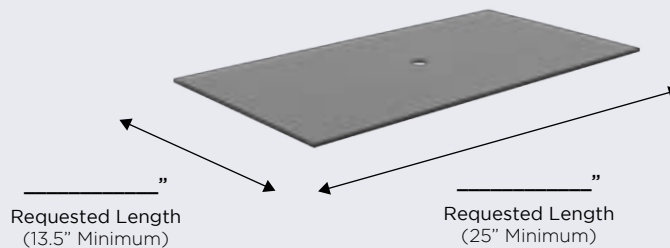

Stainless Steel Burner Cover



Submit completed form to sales@outdoorrooms.com.

Frequently Asked Questions

Crystal Fire® Plus Burners and Gas Fire Pit Tables

Are these burners and fire pits UL listed? What does that mean?

Yes, all of our burners are UL and ULC tested and listed. This means they have passed numerous tests to ensure safe operation meet current ANSI standards. They have undergone extensive wind, rain, and clearance tests.

Can I roast marshmallows over my fire table or burner?

Yes you can; however, this appliance has UL listed as a decorative gas appliance, not a cooking appliance. Make sure that combustible items do not end up in the burner, as it will clog the burner ports and prevent proper operation.

Are there different Crystal Fire® Plus burner models?

We have 22+ different Crystal Fire® Plus burners and burner kits in stock. All of these can be purchased as one complete unit or individual components. Custom burners are also available. See pages 39-45 for our offering of burners, sizes, controls, etc.

What type of fuel can I use?

You can choose from either Liquid Propane (LP), or Natural Gas (NG). Most Crystal Fire® Plus burners and stocked fire tables come set-up for LP; however, a NG conversion kit included with each unit. If converting to NG, a certified gas technician should do the installation. When ordering an electronic ignition burner, you must specify LP or NG.

Can commercial burners be used in residential applications?

Yes, many homeowners desire an electronic ignition burner system as it allows them to control the burner at a switch away from the burner, as well as use optional upgrades like remote controls.

How many BTUs per hour are produced?

The BTU rating for each burner varies by size and fuel type. For exact BTU ratings, consult the burner manual.

Can I use my OGC fire table on a wood deck?

Yes, all OGC fire pits & fire tables are okay to use on a wood deck if clearances are met. Crystal Fire® Plus burners are UL, ULC, and CE tested and listed and are used in all of our outdoor fire pits. They are okay to use on concrete patios, wood decks, composite decks, etc.

What regular maintenance should be performed?

Regularly covering and cleaning your Crystal Fire® Plus burner will extend the life of the product and keep it performing at its best. Clean all loose debris, check fittings and tighten if necessary, ensure all gas lines are intact and free from obstructions, replace batteries in sparker if needed. Consult your manual for more information.

Can I operate my fire table with a smart device?

Yes, we offer a Bluetooth® smart app option for our direct spark ignition system. You may interface your automated home system with our electronic ignition burners too. Contact OGC for more details.

Is media included with the burners or fire tables?

Yes, we include clear tempered fire glass gems with each Crystal Fire® Plus burner unless otherwise noted. Various lava rock, crushed glass, and colored glass are also available.

If I purchase a burner for my own project, what else is needed?

That depends on the project and can vary from additional controls, media, etc. You will need to specify the fuel source (LP or NG) used if it is a commercial or custom burner. We recommend working with your local OGC dealer to determine what is needed for your project. You may also contact us at sales@outdoorrooms.com.

What happens to my burner or fire table when it rains?

If the burner or fire table is uncovered, water will drain through the perimeter of the burner pan. Water will not drain through the burner neck or build up in the burner — it will safely drain out the bottom of the fire table. All fire tables and burners are constructed of outdoor-rated, durable materials.

Do I need to cover my fire table when not in use?

It is not mandatory to cover the fire table, but is recommended. Our tables are constructed of materials made to withstand outdoor exposure; however, we do recommend covering if not using for extended periods. This will prevent any unwanted debris from falling onto the burner. There are optional protective covers available.

What is the difference between a commercial burner and a residential burner?

Commercial-rated burners are often required for commercial applications (hotels, restaurants, etc.). The OGC commercial burners are identical to the residential burners except they include electronic ignition (DSI), and emergency shut off switch, and need to be ordered specifically for NG or LP. In addition, they have more options available for controls either at the burner or away from the burner.

For more troubleshooting materials, visit www.outdoorrooms.com/product-support

Custom Outdoor Kitchens

What is the design and ordering process?

Start by completing the custom outdoor kitchen request form from either our catalog or website. From here, we will communicate throughout the process on pricing and revisions. The entire process can be completed in six weeks once everything is approved. Custom forms are available at www.outdoorrooms.com/custom.

What type of grills can be built in?

Any grill that has the appropriate installation kit or specifications can be used. This includes gas, charcoal, wood, and pellet.

Can I order a custom finish to match my home?

Yes, you can also order the unit unfinished and have it finished on-site to match your house and landscape by your local dealer, contractor, or landscaper.

What are the outdoor kitchens built from?

The structure begins with G90 (marine grade) galvanized steel framing. It is then wrapped in Hardiebacker® fiber cement boarding. From there it can be finished from a variety of materials, or left unfinished to be completed on-site.

Outdoor Fireplaces

Are additional sizes available for ready-to-finish fireplaces?

We offer the ability to make custom fireplaces to your specifications. It is most cost-economical to keep the firebox and burner dimensions standard and change the structure dimensions. If you desire a different size firebox, we likely have the ability to provide you with a solution.

Can I burn wood in any of these fireplaces?

No. These units are not wood-burning fireplaces. The benefits of a gas fireplace include a smoke-free experience, turn on instantly, and provide instant heat.

Can I run a ready-to-finish fireplace on a standard LP tank?

A standard 20 lb liquid propane tank is only available for use with the 40" model. Other models will burn through gas too frequently.

Is the fire pit or fireplace approved for use in screened porches, covered porches, gazebos, or lanais?

While the unit itself is not UL approved for this application, there should not be any problem provided the following guidelines are followed:

- A minimum of three walls are screened. Screens must be permanently open. They cannot have windows that can close.
- The screened walls must provide a minimum open area of 30%.
- All appliance ceiling and wall clearances must be met.
- Minimum porch area 96 square feet.

Furniture

How do I clean the fabric?

Most stains can be cleaned with mild soap and warm water. Blot the affected area and try to remove the stain with the cleaning mixture. For more detailed instructions, please visit www.sunbrella.com.

Do I need to store my cushions from the rain and/or winter?

The furniture is built to withstand a variety of weather conditions. You can choose to store them inside if you prefer that they are clean and dry to use.

Is the furniture rust-resistant?

Yes, due to the complete powder-coating process on the frames.

Gallery Indoor Fireplaces

What is the cost to operate the electric fireplace units?

Based on national average electricity costs, the cost to operate the flame and lights is less than one penny per hour. The cost to operate the heater is about 9 cents per hour on low and 18 cents per hour on high.

Are the electric fireplace units quiet?

Yes. They have a lightweight composite shaft for the fan/blower, making it very quiet.

How big of a room will the electric fireplaces heat?

While there are many factors to consider (insulation, outdoor temperatures, openness of the room, etc.), 5,000 BTUs should be adequate to heat a room that is about 10' x 20' (200 square feet) with an eight foot ceiling.

What happens if we leave the flame on the electric fireplaces?

The unit is under warranty for 10,000 hours (400 days+). There is a safety mechanism that prevents over heating if the heater is left on for extended periods. If you operate the fireplace for 4 hours a day, the LED lights should last at least six years.

Can the electric fireplace units be installed in a bathroom?

Yes. The fireplace should be located away from a wet/splash zone and away from direct steam.

For more troubleshooting materials, visit www.outdoorrooms.com/product-support

Warranty

See user manual for more information.

PRODUCT CATEGORY	WARRANTY INFORMATION
Gas Fire Pit Tables and Crystal Fire® Plus Burners	<ul style="list-style-type: none"> • Limited lifetime warranty on all stainless steel burners installed in a residential setting, and five years on all stainless steel burners installed in a commercial setting. • One year finish warranty • One year warranty on ignition & electronics • Three year structural warranty on all fire pit bases and top
Outdoor Gas Fireplaces	<ul style="list-style-type: none"> • Limited lifetime warranty on all stainless steel burners installed in a residential setting, and five years on all stainless steel burners installed in a commercial setting. • One year finish warranty • One year warranty on ignition & electronics • Three year structural warranty on all fire pit bases and top
Gallery Collection Electric Fireplaces	<ul style="list-style-type: none"> • Two year warranty on LED lighting, fan, and heater system • One year warranty on remote
Outdoor Furniture	<ul style="list-style-type: none"> • Three year warranty on framework • Five year warranty on Sunbrella® cushions
Outdoor Kitchens	<ul style="list-style-type: none"> • Silicone grout sealant must be applied once per year to any exposed grout • 90-day parts/labor warranty on Stereo • One year parts and labor warranty on refrigerator and compressor • 5 year structural warranty on bases and tops
Accessories	<ul style="list-style-type: none"> • One year warranty on protective covers • 90-day warranty on glass wind guards • Limited lifetime warranty on stainless steel glass wind guard brackets
Non-Combustible Mantels	<ul style="list-style-type: none"> • One year warranty on finish • Three year structural warranty
Supercast™ Concrete	<ul style="list-style-type: none"> • One year structural and finish warranty • Non-structural hairline cracks are possible, and shall not be considered a manufacturing defect.



Address

9583 217th St W Suite 100
Lakeville, MN 55044

Phone

Direct: (952) 658-6730
Toll Free: 1 (866) 303-4028
Fax: (952) 658-6731

Email

Sales and Support: sales@outdoorrooms.com
Customer Service and Orders: orders@outdoorrooms.com
Marketing: marketing@outdoorrooms.com

Website

www.outdoorrooms.com



THE OUTDOOR
GREATROOM
COMPANY



www.outdoorrooms.com