

2.3 Dimensions

ENGLISH

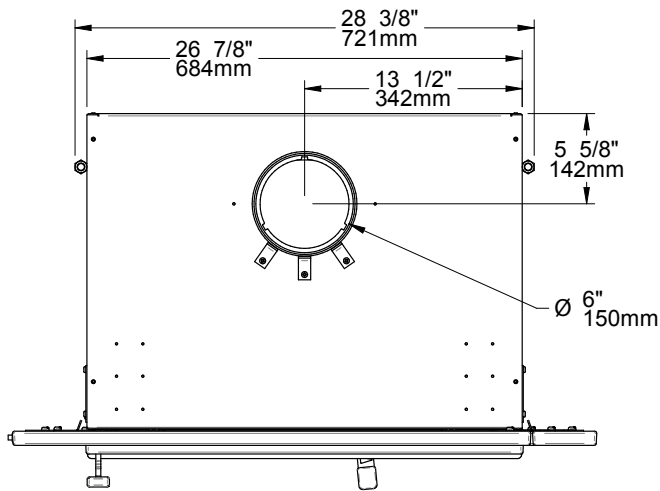

Figure 1: Top View

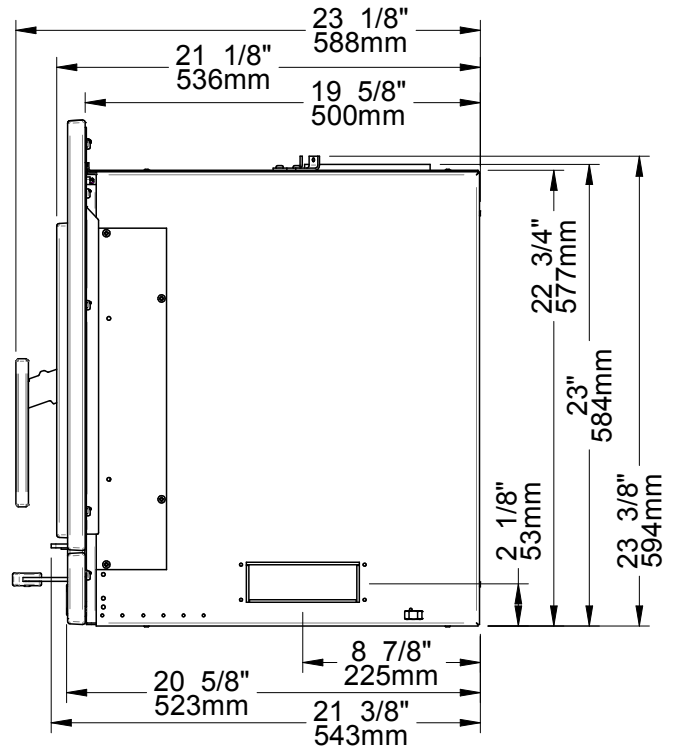

Figure 2: Side View - Minimum Insert Projection

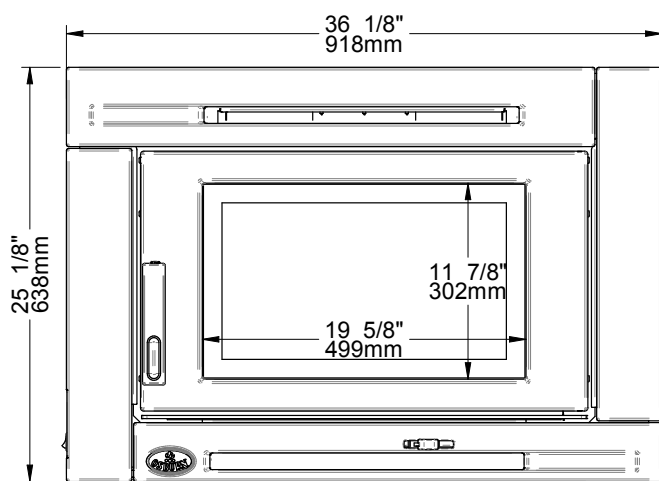

Figure 3: Front View

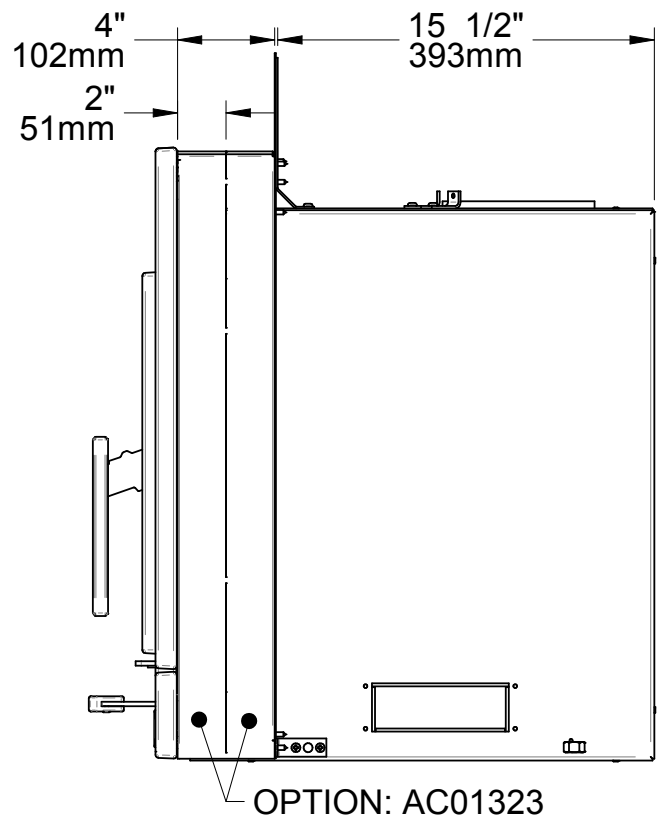

Figure 4: Side View - Maximum Insert Projection

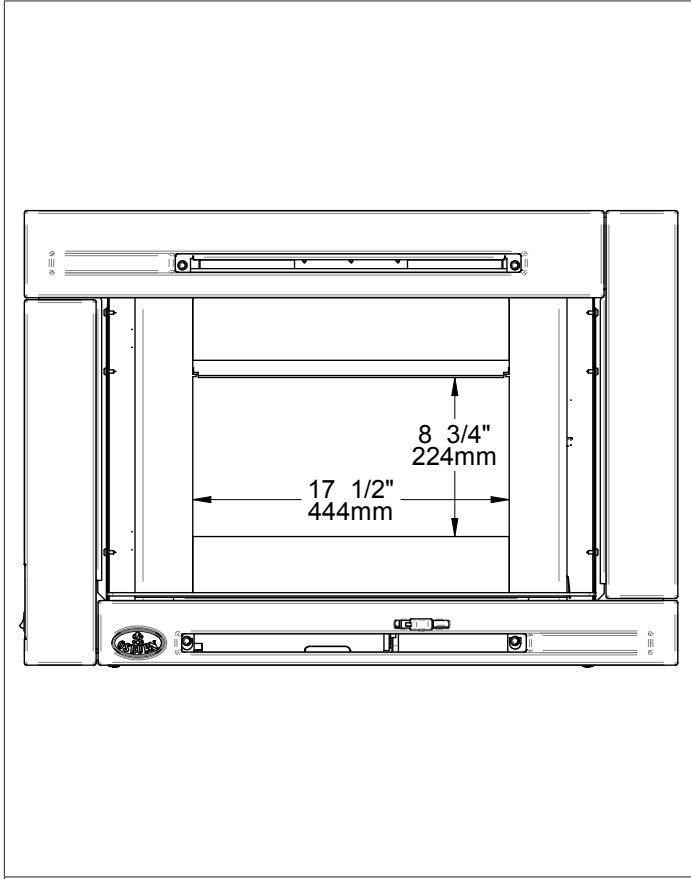

Figure 5: Door Opening

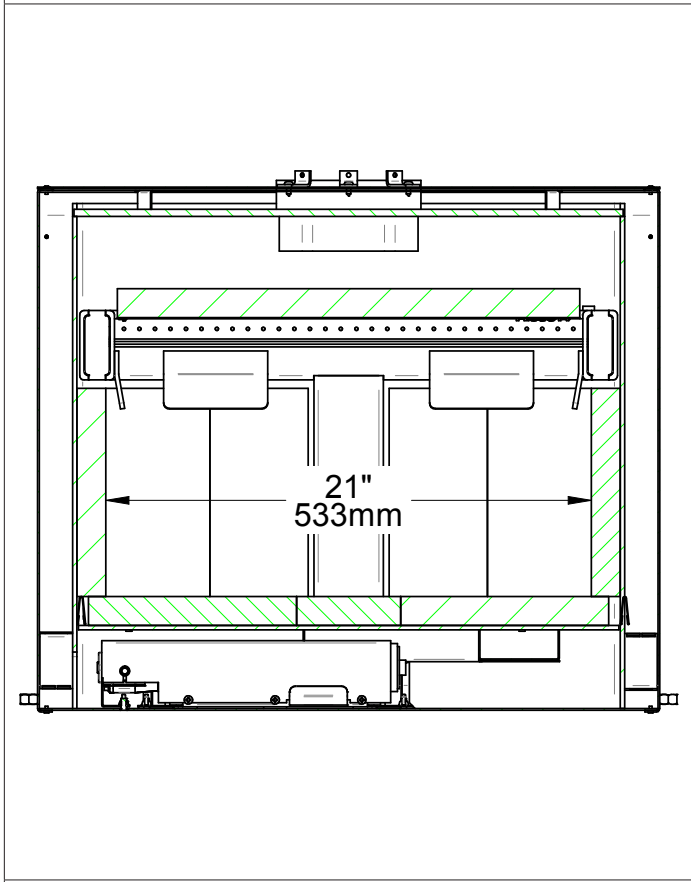

Figure 6: Front View - Combustion Chamber

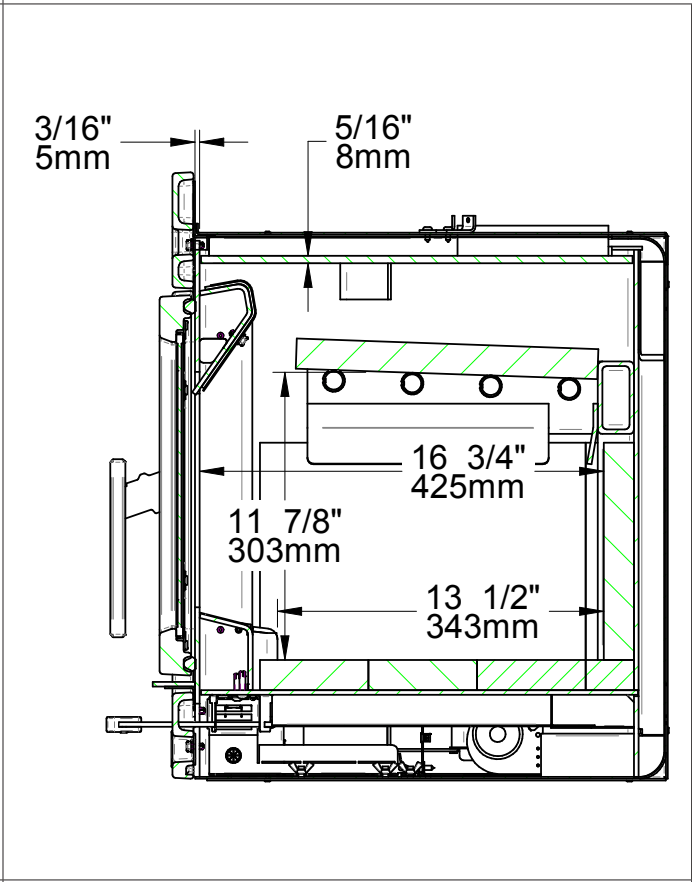

Figure 7: Side View - Combustion Chamber