

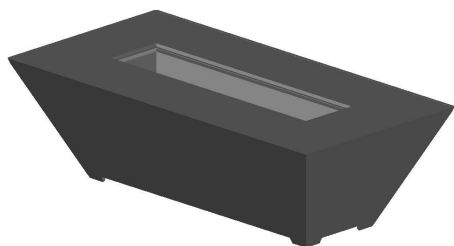

Olympus Fire Table Installation & Operation Manual



Rectangular

ORECFT-603018-"Color"- "NG/LP"
ORECFT-723018-"Color"- "NG/LP"

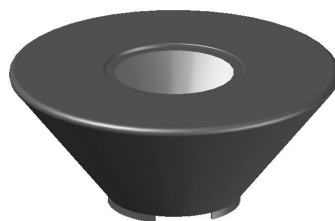

Round

ORNDFT-444418-"Color"- "NG/LP"

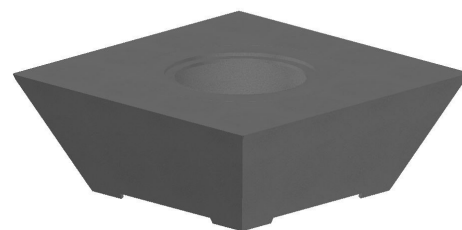

Square

OSQRFT-484818-"Color"- "NG/LP"

WARNING: If the information in this manual is not followed exactly, a fire or explosion may result, causing property damage, personal injury or loss of life

Do not store or use gasoline or other flammable vapors and liquids in the vicinity of this or any application

WHAT TO DO IF YOU SMELL GAS

Do not try to light any appliance

Do not touch any electrical switch

Do not use any phone in the building

Immediately call the gas supplier from a neighbor's phone. Follow the gas

supplier's instructions

If you cannot reach the gas supplier, call the fire department.

Installation and service must be performed by a qualified installer, service agency or the gas supplier

IF YOU CAN NOT READ OR UNDERSTAND THESE INSTALLATION INSTRUCTIONS DO NOT ATTEMPT TO INSTALL OR OPERATE THIS DEVICE

INSTALLER: Leave this manual with the fire table
CONSUMER: Retain this manual for future reference.

Ventilation is incorporated into ALL Olympus Fire Tables.

WARNING: Do not operate this fire feature in high-wind conditions. Operating in high-wind conditions may expose your model to direct flame, which will result in cracking and discoloration to the finish.

CARBON MONOXIDE HAZARD

This appliance can produce carbon monoxide which has no odor.

Using it in an enclosed area can kill you.

Never use this appliance in an enclosed space such as a camper, tent, car or home.



Combustion byproducts produced when using this product contains chemicals known to the state of California to cause cancer, birth defects or other reproductive harm.

Handling the brass material on this product exposes you to lead, a chemical known to the state of California to cause cancer, birth defects or other reproductive harm (wash hands after handling this product)

For more information go to this website
www.P65warnings.ca.gov



Warning: For Outdoor Use Only

Dimensions & Parts List

Rectangular Fire Table

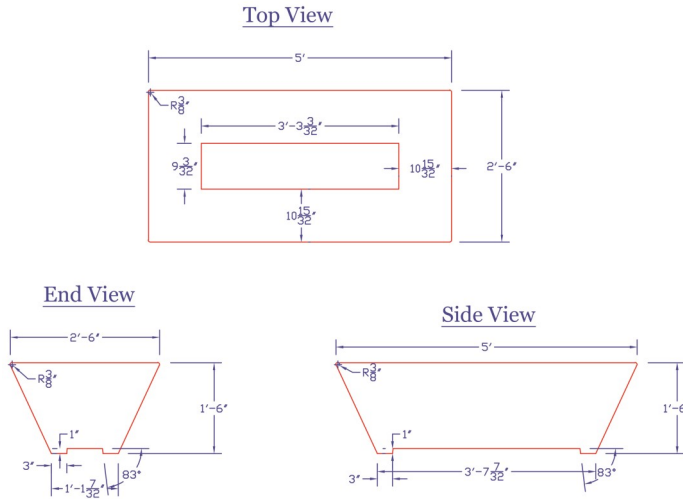

Square Fire Table

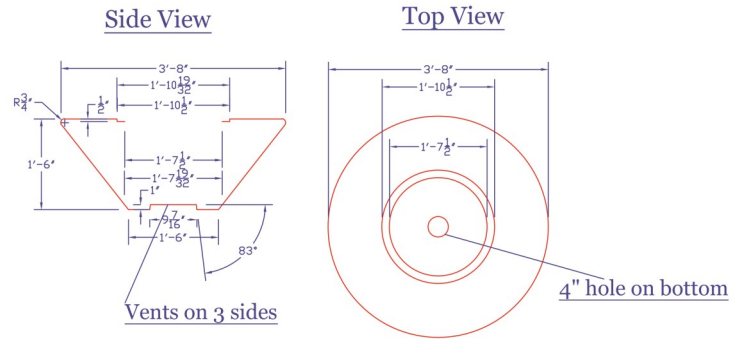

Square Fire Table

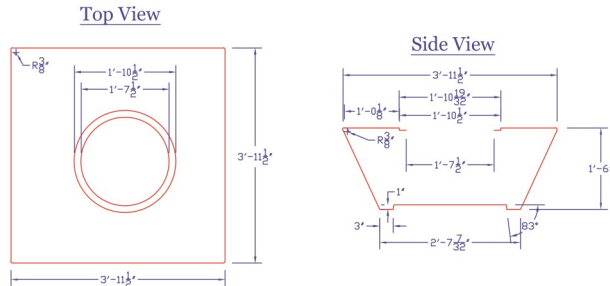

Minimum Clearance To Combustibles		
Side Walls	Ceiling	Floor
16"	68"	N/A

Pressure	NG	LP
Min. Inlet	3.5" W.C.	8" W.C.
Max. Inlet	14" W.C.	14" W.C.
Normal	7" W.C.	11" W.C.

Burner Specifications

Model #	Pan Length	Pan Width	Burner Length	Burner Width	BTU NG	BTU LP
DIP-LN-48	51"	8.5"	44"	0.5"	95K	95K
DIP-LN-36	39"	9"	34"	0.5"	65K	65K
DIP-RN-19	22"	22"	12"	12"	65K	65K

Parts List

1.	Fire Table
2.	Burner & Pan
3.	NG or LP Orifice
4.	Installation Kit
5.	Installation Manual

1. Fire Table (Not Shown Below) is available in Rectangular, Round or Square. Fire Tables also available in 5 colors, Black "BLK", Gray "GRY", White "WHT", Rust "RST" & Bone "BON".
2. Rectangular Fire Tables accept liner drop-in burner. Square & Round Fire Tables accept round drop-in burner.
3. Pre drilled Orifices for Natural Gas or Liquid Propane are included
4. Install Kit Includes mounting bracket, 1/2" key valve, 3" Key, Flex line & connection fittings



Installation Instructions

1. The Olympus Fire Table is for Outdoor Use ONLY. **DO NOT** install indoors. **DO NOT** attempt to install LP Tank under Fire Table.
2. Refer to the NFPA54 (National Fuel Gas Code) for proper pipe sizing. Follow the local code requirements for the gas type being used. This fire feature should be installed in accordance with local codes and ordinances or in the absence of local codes, with the latest National Fuel Gas Code, ANSI Z223.1 NFPA54 or CSA B149.1, Natural and Propane Installation Code in Canada.
3. Carefully prepare installation area making sure that area is clear of all debris & combustible material. DO NOT install the fire table on grass, dirt or soft material as this will prevent proper ventilation.
4. Using Proper pipe dope or Teflon tape on the threaded pipe nipple on the bottom of the Linear or Round burner, Screw on the Natural Gas or Propane orifice with an open ended wrench.
5. Once the orifice is in place, attach the 1/2" FIP x 5/8" Flare fitting to the bottom of the pan. Next connect the 5/8" whistle free flex line to the bottom of the pan.
6. Using the additional flare x MIP straight fitting insert that into the side of the key valve. The key way valve is direction, thus make sure the arrow is pointing in the direction of the gas flow.
7. Connect your incoming gas line to the key way valve following the directional flow arrow on the valve.
8. Check ALL gas connections with soapy water to ensure gas connection are leak free.
9. For Installation with Weather Beater Hot Surface Ignition system, Please refer to Weather Beater Manual.

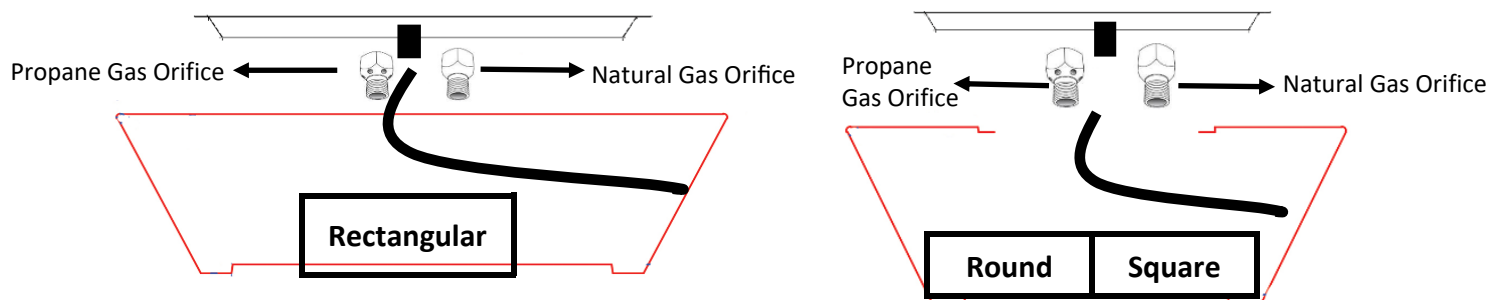

Media Installation

1. All media lava rock and/or fire glass has the potential of thermal spalling. This is a process that may occur when media is wet and moisture gets trapped inside of the material due to rapid temperature differences. When this happens the media has the potential to crack or "pop" outside of the fire-pit.
2. If Purchased Install lava rock into the burner pan. Ensure that lava rock is a 1" to 2" inch in diameter for proper operation. DO NOT pour lava directly from the bag due to the dust that can collect in the bag. It should be placed naturally and NOT packed in tightly. Loose fitting is important to ensure robust flames. Be sure rocks are free of dust as this ensures the burner pan weep hole do not get clogged up. IF USED the pilot head must not be completely covered to ensure proper pilot hood ventilation
3. If purchased Install the glass media into the burner pan. Ensure the glass media is 1/2" to 3/4" in size & rated for use with fire. Carefully pour the glass into the burner pan & cover the burner completely with no more than 1" of media over the top of the burner. IF USED the pilot head must not be completely covered to ensure proper pilot hood ventilation
4. Logs and or Cannon Balls can be use as accent pieces laid on top of previously mentioned media.

Burner Pan Style	Required Media Lava Rock / Fireglass
Linear	20 lbs.
Round	30 lbs.

Warranty

Refractory Logs: Grand Canyon Gas Logs, logs carry a lifetime warranty against any manufacture defects or breakage as long as the products are installed inside. In the event defect or breakage occurs a replacement will be available to pick-up from the dealer at which the log set was originally purchased. This warranty does not cover breakage caused by excessive handling once installed and fired. Logs installed outdoors carry a (1) year warranty. This warranty is limited to original purchaser only.

Burner: Grand Canyon Gas Logs outdoor stainless steel burners carry a life time warranty against manufacture defects or breakage as long as the appliance is installed by a professional installer. In the event a defect or breakage occurs a replacement will be available for pick-up from the dealer at which the burner was originally purchased.

Electrical and Valves: Grand Canyon Gas Logs valves, pilot assemblies and electrical components carry a (1) year warranty against breakage or defects from date of purchase, by original purchaser, and must be installed be a licensed professional installer. This warranty only covers use with Grand Canyon Gas Logs burners and logs In the event a defect or breakage occurs a replacement will be available for pick-up from the dealer at which the burner was originally purchased.

GFRC Fire-Tables: Grand Canyon Gas Logs GFRC Fire Tables carry a (1) year warranty against manufacture defects. Grand Canyon Gas Logs will replace product which has proven to be defective in workmanship and material. ALL Fire-Tables **MUST** be covered when not in use to prevent efflorescence. Damage due to severe or catastrophic weather is not covered under this warranty. The warranty is limited to the original purchaser, and must be installed be a licensed professional installer. This warranty only covers use with Grand Canyon Gas Logs burners and logs In the event a defect or breakage occurs a replacement will be available for pick-up from the dealer at which the burner was originally purchased.

Care & Cleaning of the Product: Standard Concrete and GFRC Products can be cleaned by simply wiping down the product using a solution of 1-part vinegar to 4-parts of water. If areas of excess dirt exist, us a a soft bristled brush to gently scrub the surface then rinse with clean water. Cleaning and/or resealing of the product should follow the instructions of the sealer to be applied. For cold weather applications, it is always best that all products remain as dry as possible and all water is drained prior to freezing temperatures. The installer is responsible for the implementation and design of the need for cold weather care procedures. Covers can be utilized and are a suggested cold weather application need but covers alone will typically not meet all requirements. Hard freeze of product may cause damage to the product.

DFW Coping Glass Fiber Reinforced Concrete Products (GFRC): GFRC products are made with, but not limited to Portland Cement, Glass Fibers, Silicon Aggregate and Water all of which are Non-Combustible and meets the requirements of ASTM E-136. In addition, test for non-combustibility, ignitability and fire propagation have been conducted in accordance with "Fire Test on Building Materials and Structures". BS476, Part 4,5 and Section 6532. GFRC also meets the requirements of NFPA (National Fire Protection Agency) Class A and UBC Class 1 when tested in accordance to ASTM E84, resulting in a "O" Flame Spread Rating and less than a 5-smoke density. Additionally, the DFW Coping GFRC products contain internal waterproofing materials to enhance the products to withstand water and planter applications.

WARRANTY CARD

Please fill this warrant card and copy & mail it to Grand Canyon Gas Logs to receive a warranty claim

Purchased from _____

City _____ State _____

Day/Month/Year _____

Name _____

City _____ State _____

Phone Number _____ Email _____

Date of install _____

Copy & Mail to:

Grand Canyon Gas Logs 3515 E. Atlanta Ave. Phoenix, AZ 85040