

# PANS & BURNERS



# THE OUTDOOR PLUS

USA MANUFACTURER OF FIRE & WATER PRODUCTS



# THE OUTDOOR PLUS BURNERS

◆ **Works with LP or NG**

All of TOP's burners are suitable for any fire pit or fire bowl whether they are natural gas or liquid propane

◆ **Water Runoff Protection**

The inlets on all TOP burners are raised and tapered so that if water does enter the burner, it will not enter the gas line.

◆ **Multiple Drain Holes**

Each burner has multiple drain holes to release any water that may enter the burner through the flame holes.

◆ **Drain Hole Tab**

With the The drain holes pointed to the side, we add a tab to redirect the flame upward to retain the intended flame pattern. Other burners have drain holes which create an unappealing flame

◆ **.065 Wall Thickness & Stainless Steel Construction**

The wall thickness of T.O.P's stainless steel burners is greater than most burners on the market. Along with the 304 stainless steel construction. This ensures a long burner life and resists warping.

**Individually Drilled Holes**  
Improved flame pattern and gas flow compared to punched holes

**Downward Taper**  
The Downward taper prevents water from traveling up the cross member and entering the gas line.

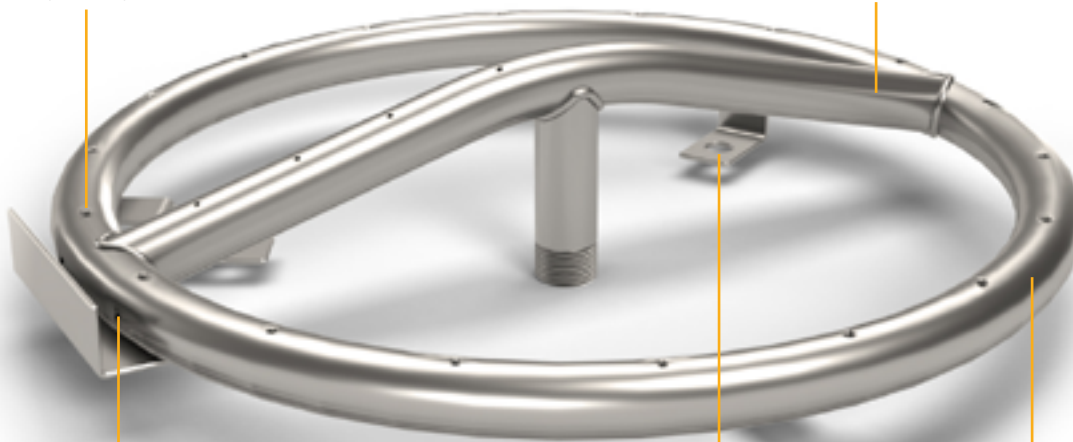

**Drain Holes on Side**  
Prevents water from building up inside the burner and potentially entering the gas line

**Manufactured By Hand**  
This ensures that each burner is inspected by multiple people along the assembly line and meets T.O.P's high quality standards

**Anchoring Tabs**  
These tabs come with every burner to give you the option to anchor it onto the fire pan.

**Using Propane? Make Sure You Use an LP Air Mix Orifice**

Compared to Natural Gas (NG), Propane Gas (LP) is much more volatile and requires more oxygen for combustion.

Because of this, an air mixer is installed under the burner to lean out the gas, and minimize propane soot.

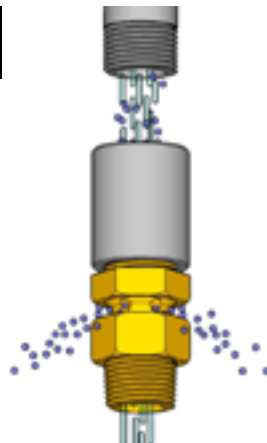

**All Outdoor Plus Kits Come With Orifices**

All of T.O.P's burner kits & fire pits include an orifice which helps regulate & save gas.

The LP air mix orifice includes an adjustable nut to control the amount of air that is mixed with the gas



**LP ORIFICE**

**NG ORIFICE**

# BUILD YOUR OWN FIRE PIT

If you are building a fire pit from scratch using paver blocks, use these components to eliminate the hassle of figuring out which components you'll need. All you need to know is the desired fire pit opening and find a flat pan kit to fit.

## 'Build Your Own' Fire Pit Checklist

- 1 Choose any desired Pan & Burner Kit
- 2 Find perimeter of Fire Pit Area and get the required Z-Brackets for any flat pan application
- 3 Get the Paver Bracket with Key Valve and Gas Line. Choose either LP or NG (Paver brackets are width adjustable from 8" - 14")
- 4 Don't forget your ventilation (Prevents dangerous gas buildup inside the enclosure)
- 5 Finally, your access doors to hide away a propane tank or to make future maintenance a breeze! Optional but highly recommended

## Completed Fire Pit

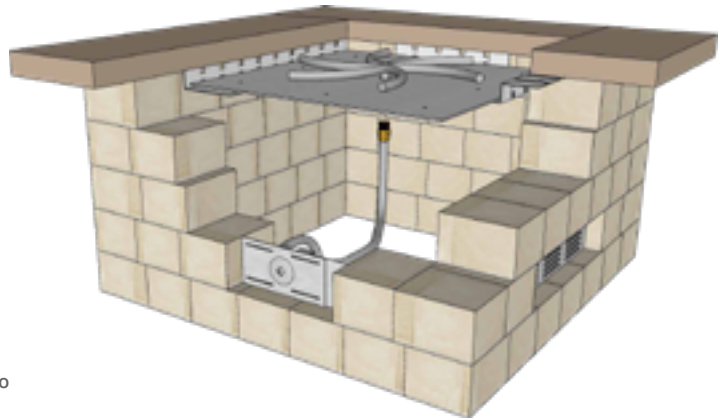

## Gas Kit with Paver Bracket

The Paver Bracket makes it easy to install a key valve onto any DIY paver/brick fire pit. Simply install it in place of a paver. Adhere using a couple of anchors or adhesive.  
**Height:** 3.875" ; **Width:** Min - 8" , Max - 14" ; **Depth:** 4"

### NG Gas Kit with Paver Bracket

OPT-PB256NG - Natural Gas  
 OPT-PB256NGHC - Natural Gas over 300K BTU  
 » Includes: Adjustable SS Bracket, Key Valve, Turn Key, 24" 1/2" Whistle Free Hoses (2x), NG Orifice

### LP Gas Kit with Paver Bracket

OPT-PB256LP - Liquid Propane  
 OPT-PB256LPHC - Liquid Propane over 300K BTU  
 » Includes: Adjustable SS Bracket, Key Valve, Turn Key, 24" 3/8" Whistle Free Hose, LP Regulator, LP Air Mix Orifice



## Rectangular Vents

- » Aluminum Vent for all fire pits
- » Flush Surface Mount

**5" x 4" Vent** OPT-VENT54  
**16" x 4" Vent** OPT-VENT164

Custom sizes available



## Access Door

- » Doors come equipped with a lock latch.
- » Includes holes for added ventilation
- » 304 Stainless Steel
- » Brushed Finish.

**14" x 17" Door** OPT-ADSS1417  
**8" x 8" Door** OPT-ADSS88  
**10" x 10" Door** OPT-ADSS1010  
**12" x 12" Door** OPT-ADSS1212

Custom sizes available



## Round Vents

- » Aluminum Vent for all fire pits
- » Inserts into 2", 3", or 4" hole
- » Depth: 3/4"

**2" Vent** OPT-RVENT2  
**3" Vent** OPT-RVENT3  
**4" Vent** OPT-RVENT4

Custom sizes available

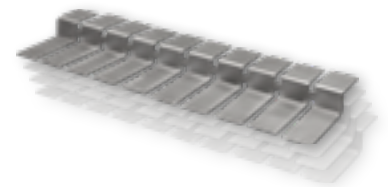

## 24" Z-Mounting Brackets

OPT-ZBRKT

- » Z-Brackets are designed to ease the installation of flat pan kits in DIY Fire Pits
- » Brackets are flexible to suit both rectangle & round fire pit's burn areas
- » Made of 304 Stainless Steel
- » **Length:** 24" ; **Height:** 2" ; **Depth:** 5"



## Custom Stainless Steel Vents

We can make vents for your fire feature in any shape and any size, and even with a custom design. Call or email us today to inquire about custom vents.

The Patented Bullet Burner's eliminate the need for an additional LP air mixer. Suitable for either natural gas or liquid propane applications. Electronic ignition systems require 10" clearance below the pan. 110V Ignition System Kits use a 3-prong grounded plug.

**BURNER SIZE GUIDE:** M = Double Inlet and uses manifold that adds 5" in height below the pan ; 2R = 2 Rings ; 3R = 3 Rings ; 4R = 4 Rings



## Round Flat Pan & Bullet Burner

ITEM	PAN & BURNER ONLY	FLAME SENSE MATCH LIT CERTIFIED	FLAME SENSE W/ SPARK IGNITION	ELECTRONIC 12V CSA CERTIFIED	ELECTRONIC 110V CSA CERTIFIED	BURNER SIZE	GAS INLET	BTU
18" Pan Kit - A	OPT-BFP18R	OPT-BFP18RFSML	OPT-BFP18RFSEN	OPT-BFP18RE12	OPT-BFP18RE110	8"	½"	50,000
18" Pan Kit - B	OPT-BFP182R	OPT-BFP182RFSML	OPT-BFP182RFSEN	OPT-BFP182RE12	OPT-BFP182RE110	12"	½"	75,000
24" Pan Kit	OPT-BFP24R	OPT-BFP24RFSML	OPT-BFP24RFSEN	OPT-BFP24RE12	OPT-BFP24RE110	18"	½"	110,000
30" Pan Kit	OPT-BFP30R	N/A	OPT-BFP30RFSEN	OPT-BFP30RE12	OPT-BFP30RE110	24"	½"	145,000
36" Pan Kit	OPT-BFP36R	N/A	OPT-BFP36RFSEN	OPT-BFP36RE12	OPT-BFP36RE110	30"	¾"	180,000
48" Pan Kit	OPT-BFP48R	N/A	N/A	OPT-BFP48RE12	OPT-BFP48RE110	36"	¾"	220,000
60" Pan Kit	OPT-BFP60R	N/A	N/A	OPT-BFP60RE12	OPT-BFP60RE110	48"	¾"	385,000



## Square Flat Pan & Bullet Burner

ITEM	PAN & BURNER ONLY	FLAME SENSE MATCH LIT CERTIFIED	FLAME SENSE W/ SPARK IGNITION	ELECTRONIC 12V CSA CERTIFIED	ELECTRONIC 110V CSA CERTIFIED	BURNER SIZE	GAS INLET	BTU
18" Pan Kit - A	OPT-BFP18S	OPT-BFP18SFSML	OPT-BFP18SFSEN	OPT-BFP18SE12	OPT-BFP18SE110	8"	½"	50,000
18" Pan Kit - B	OPT-BFP182S	OPT-BFP182SFSML	OPT-BFP182SFSEN	OPT-BFP182SE12	OPT-BFP182SE110	12"	½"	75,000
24" Pan Kit	OPT-BFP24S	OPT-BFP24SFSML	OPT-BFP24SFSEN	OPT-BFP24SE12	OPT-BFP24SE110	18"	½"	110,000
30" Pan Kit	OPT-BFP30S	N/A	OPT-BFP30SFSEN	OPT-BFP30SE12	OPT-BFP30SE110	24"	½"	145,000
36" Pan Kit	OPT-BFP36S	N/A	OPT-BFP36SFSEN	OPT-BFP36SE12	OPT-BFP36SE110	30"	¾"	180,000
48" Pan Kit	OPT-BFP48S	N/A	N/A	OPT-BFP48SE12	OPT-BFP48SE110	36"	¾"	220,000
60" Pan Kit	OPT-BFP60S	N/A	N/A	OPT-BFP60SE12	OPT-BFP60SE110	48"	¾"	385,000

MORE ELECTRONIC IGNITION ACCESSORIES ON PAGES 155

MORE GAS ACCESSORIES ON PAGES 158



# FLAT PAN BRASS BULLET BURNER KITS

PATENTED DESIGN

LIFETIME WARRANTY ON ALL BURNERS

The Patented Bullet Burner's eliminate the need for an additional LP air mixer. Suitable for either natural gas or liquid propane applications. Electronic ignition systems require 10" clearance below the pan. 110V Ignition System Kits use a 3-prong grounded plug.

**BURNER SIZE GUIDE:** **M** = Double Inlet and uses manifold that adds 5" in height below the pan ; **2R** = 2 Rings ; **3R** = 3 Rings ; **4R** = 4 Rings



## Rectangular Flat Pan & Linear Bullet Burner

ITEM	PAN & BURNER ONLY	FLAME SENSE MATCH LIT CERTIFIED	FLAME SENSE W/ SPARK IGNITION	ELECTRONIC 12V CSA CERTIFIED	ELECTRONIC 110V CSA CERTIFIED	BURNER SIZE	GAS INLET	BTU
24"x8" Pan Kit	OPT-BFP24RT	OPT-BFP24RTFSML	OPT-BFP24RTFSEN	OPT-BFP24RE12	OPT-BFP24RE110	18"	½"	40,000
36"x8" Pan Kit	OPT-BFP36RT	OPT-BFP36RTFSML	OPT-BFP36RTFSEN	OPT-BFP36RE12	OPT-BFP36RE110	30"	½"	50,000
48"x8" Pan Kit	OPT-BFP48RT	OPT-BFP48RTFSML	OPT-BFP48RTFSEN	OPT-BFP48RE12	OPT-BFP48RE110	42"	½"	75,000
60"x8" Pan Kit	OPT-BFP60RT	OPT-BFP60RTFSML	OPT-BFP60RTFSEN	OPT-BFP60RE12	OPT-BFP60RE110	48"	½"	100,000
72"x8" Pan Kit	OPT-BFP72RT	OPT-BFP72RTFSML	OPT-BFP72RTFSEN	OPT-BFP72RE12	OPT-BFP72RE110	60"	½"	120,000
84"x8" Pan Kit	OPT-BFP84RT	N/A	N/A	OPT-BFP84RE12	OPT-BFP84RE110	72"	½"	145,000
96"x8" Pan Kit	OPT-BFP96RT	N/A	N/A	OPT-BFP96RE12	OPT-BFP96RE110	84"	¾"	170,000



## Rectangular Flat Pan & 'H' Bullet Burner

ITEM	PAN & BURNER ONLY	FLAME SENSE MATCH LIT CERTIFIED	FLAME SENSE W/ SPARK IGNITION	ELECTRONIC 12V CSA CERTIFIED	ELECTRONIC 110V CSA CERTIFIED	BURNER SIZE	GAS INLET	BTU
24"x12" Pan Kit	OPT-BFP1224R	OPT-BFP1224RFSML	OPT-BFP1224RFSEN	OPT-BFP1224RE12	OPT-BFP1224RE110	18" x 6"	½"	85,000
36"x12" Pan Kit	OPT-BFP1236R	OPT-BFP1236RFSML	OPT-BFP1236RFSEN	OPT-BFP1236RE12	OPT-BFP1236RE110	24" x 6"	½"	110,000
48"x12" Pan Kit	OPT-BFP1248R	OPT-BFP1248RFSML	OPT-BFP1248RFSEN	OPT-BFP1248RE12	OPT-BFP1248RE110	36" x 6"	½"	160,000
60"x12" Pan Kit	OPT-BFP1260R	N/A	N/A	OPT-BFP1260RE12	OPT-BFP1260RE110	48" x 6"	½"	205,000
72"x12" Pan Kit	OPT-BFP1272R	N/A	N/A	OPT-BFP1272RE12	OPT-BFP1272RE110	60" x 6" (M)	½"	255,000
84"x12" Pan Kit	OPT-BFP1284R	N/A	N/A	OPT-BFP1284RE12	OPT-BFP1284RE110	72" x 6" (M)	½"	30,000
96"x12" Pan Kit	OPT-BFP1296R	N/A	N/A	OPT-BFP1296RE12	OPT-BFP1296RE110	84" x 6" (M)	½"	350,000



# DROP-IN PAN BRASS BULLET BURNER KITS

PATENTED DESIGN

LIFETIME WARRANTY ON ALL BURNERS

Bullet Burner's eliminate the need for an additional LP air mixer. Suitable for either natural gas or liquid propane applications. Pans have 1" Lip & 2" Height. Electronic ignition requires 10" clearance below the pan. 110V Ignition System Kits use a 3-prong grounded plug.

**BURNER SIZE GUIDE:** **M** = Double Inlet and uses manifold that adds 5" in height below the pan ; **2R** = 2 Rings ; **3R** = 3 Rings ; **4R** = 4 Rings



12V Ignition

110V Ignition

Flame Sense w/ Spark Ignition

Flame Sense

## SS Round Drop In Pan & Bullet Burner

ITEM	PAN & BURNER ONLY	FLAME SENSE MATCH LIT CERTIFIED	FLAME SENSE W/ SPARK IGNITION	ELECTRONIC 12V CSA CERTIFIED	ELECTRONIC 110V CSA CERTIFIED	BURNER SIZE	GAS INLET	BTU
13" Pan Kit	OPT-BP13RD	OPT-BP13RDFSML	OPT-BP13RDFSSEN	OPT-BP13RDE12	OPT-BP13RDE110	8"	½"	50,000
19" Pan Kit	OPT-BP19RD	OPT-BP19RDFSML	OPT-BP19RDFSSEN	OPT-BP19RDE12	OPT-BP19RDE110	12"	½"	75,000
25" Pan Kit	OPT-BP25RD	OPT-BP25RDFSML	OPT-BP25RDFSSEN	OPT-BP25RDE12	OPT-BP25RDE110	18"	½"	110,000
31" Pan Kit	OPT-BP31RD	N/A	OPT-BP31RDFSSEN	OPT-BP31RDE12	OPT-BP31RDE110	24"	½"	145,000
37" Pan Kit	OPT-BP37RD	N/A	N/A	OPT-BP37RDE12	OPT-BP37RDE110	30"	¾"	180,000
43" Pan Kit	OPT-BP43RD	N/A	N/A	OPT-BP43RDE12	OPT-BP43RDE110	36"	¾"	220,000



12V Ignition

110V Ignition

Flame Sense w/ Spark Ignition

Flame Sense

## SS Square Drop In Pan & Bullet Burner

ITEM	PAN & BURNER ONLY	FLAME SENSE MATCH LIT CERTIFIED	FLAME SENSE W/ SPARK IGNITION	ELECTRONIC 12V CSA CERTIFIED	ELECTRONIC 110V CSA CERTIFIED	BURNER SIZE	GAS INLET	BTU
12" Pan Kit	OPT-BP12SD	OPT-BP12SDFSML	OPT-BP12SDFSSEN	OPT-BP12SDE12	OPT-BP12SDE110	8"	½"	50,000
18" Pan Kit	OPT-BP18SD	OPT-BP18SDFSML	OPT-BP18SDFSSEN	OPT-BP18SDE12	OPT-BP18SDE110	12"	½"	75,000
24" Pan Kit	OPT-BP24SD	OPT-BP24SDFSML	OPT-BP24SDFSSEN	OPT-BP24SDE12	OPT-BP24SDE110	18"	½"	110,000
30" Pan Kit	OPT-BP30SD	N/A	OPT-BP30SDFSSEN	OPT-BP30SDE12	OPT-BP30SDE110	24"	½"	145,000
36" Pan Kit	OPT-BP36SD	N/A	N/A	OPT-BP36SDE12	OPT-BP36SDE110	30"	¾"	180,000
48" Pan Kit	OPT-BP48SD	N/A	N/A	OPT-BP48SDE12	OPT-BP48SDE110	36"	¾"	220,000



# DROP-IN PAN BRASS BULLET BURNER KITS

PATENTED DESIGN

LIFETIME WARRANTY ON ALL BURNERS

Bullet Burner's eliminate the need for an additional LP air mixer. Suitable for either natural gas or liquid propane applications. Pans have 1" Lip & 2" Height. Electronic ignition requires 10" clearance below the pan. 110V Ignition System Kits use a 3-prong grounded plug.

**BURNER SIZE GUIDE:** **M** = Double Inlet and uses manifold that adds 5" in height below the pan ; **2R** = 2 Rings ; **3R** = 3 Rings ; **4R** = 4 Rings



## SS Rectangular Drop In Pan & Linear Bullet Burner

ITEM	PAN & BURNER ONLY	FLAME SENSE MATCH LIT CERTIFIED	FLAME SENSE W/ SPARK IGNITION	ELECTRONIC 12V CSA CERTIFIED	ELECTRONIC 110V CSA CERTIFIED	BURNER SIZE	GAS INLET	BTU
24"x8" Pan Kit	OPT-BP824RD	OPT-BP824RDFSML	OPT-BP824RDFSEN	OPT-BP824RDE12	OPT-BP824RDE110	18"	½"	40,000
36"x8" Pan Kit	OPT-BP836RD	OPT-BP836RDFSML	OPT-BP836RDFSEN	OPT-BP836RDE12	OPT-BP836RDE110	24"	½"	50,000
48"x8" Pan Kit	OPT-BP848RD	OPT-BP848RDFSML	OPT-BP848RDFSEN	OPT-BP848RDE12	OPT-BP848RDE110	36"	½"	75,000
60"x8" Pan Kit	OPT-BP860RD	OPT-BP860RDFSML	OPT-BP860RDFSEN	OPT-BP860RDE12	OPT-BP860RDE110	48"	½"	100,000
72"x8" Pan Kit	OPT-BP872RD	OPT-BP872RDFSML	OPT-BP872RDFSEN	OPT-BP872RDE12	OPT-BP872RDE110	60"	¾"	120,000
84"x8" Pan Kit	OPT-BP884RD	N/A	N/A	OPT-BP884RDE12	OPT-BP884RDE110	72"	¾"	145,000
96"x8" Pan Kit	OPT-BP896RD	N/A	N/A	OPT-BP896RDE12	OPT-BP896RDE110	84"	¾"	170,000



## SS Rectangular Drop In Pan & 'H' Bullet Burner

ITEM	PAN & BURNER ONLY	FLAME SENSE MATCH LIT CERTIFIED	FLAME SENSE W/ SPARK IGNITION	ELECTRONIC 12V CSA CERTIFIED	ELECTRONIC 110V CSA CERTIFIED	BURNER SIZE	GAS INLET	BTU
24"x12" Pan Kit	OPT-BP1224RD	OPT-BP1224RDFSML	OPT-BP1224RDFSEN	OPT-BP1224RDE12	OPT-BP1224RDE110	18" x 6"	½"	85,000
36"x12" Pan Kit	OPT-BP1236RD	OPT-BP1236RDFSML	OPT-BP1236RDFSEN	OPT-BP1236RDE12	OPT-BP1236RDE110	24" x 6"	½"	110,000
48"x12" Pan Kit	OPT-BP1248RD	OPT-BP1248RDFSML	OPT-BP1248RDFSEN	OPT-BP1248RDE12	OPT-BP1248RDE110	36" x 6"	½"	160,000
60"x12" Pan Kit	OPT-BP1260RD	N/A	N/A	OPT-BP1260RDE12	OPT-BP1260RDE110	48" x 6"	½"	205,000
72"x12" Pan Kit	OPT-BP1272RD	N/A	N/A	OPT-BP1272RDE12	OPT-BP1272RDE110	60" x 6" (M)	¾"	255,000
84"x12" Pan Kit	OPT-BP1284RD	N/A	N/A	OPT-BP1284RDE12	OPT-BP1284RDE110	72" x 6" (M)	½"	300,000
96"x12" Pan Kit	OPT-BP1296RD	N/A	N/A	OPT-BP1296RDE12	OPT-BP1296RDE110	84" x 6" (M)	½"	300,000

MORE ELECTRONIC IGNITION ACCESSORIES ON PAGES 155

MORE GAS ACCESSORIES ON PAGES 158

<p>REMOTE CONTROL &amp; WIRELESS RECEIVER OPT-RC110V</p>	<p>WEATHERPROOF ON/OFF SWITCH OPT-WPS110V</p>	<p>110V EMERGENCY STOP BUTTON OPT-ESTOP</p>	<p>110V 1-HOUR DIAL TIMER OPT-DTM</p>	<p>GAS TIMER &amp; EMERGENCY STOP OPT-ESTOPTM</p>	<p>NATURAL GAS KIT OPT-NGKNG - 0-290K BTU OPT-NGKNGHC - 291K+ BTU</p>	<p>LIQUID PROPANE KIT OPT-LPKLP - 0-290K BTU OPT-LPKLPHC - 291K+ BTU</p>
--	---	---	---	---	---	--

Proudly Made In The USA

The Patented Bullet Burner's eliminate the need for an additional LP air mixer. Suitable for either natural gas or liquid propane applications. Electronic ignition systems require 10" clearance below the pan. 110V Ignition System Kits use a 3-prong grounded plug.

**BURNER SIZE GUIDE:** M = Double Inlet and uses manifold that adds 5" in height below the pan ; 2R = 2 Rings ; 3R = 3 Rings ; 4R = 4 Rings



## Round Flat Pan & SS Triple S Bullet Burner

ITEM	PAN & BURNER ONLY	FLAME SENSE MATCH LIT CERTIFIED	FLAME SENSE W/ SPARK IGNITION	ELECTRONIC 12V CSA CERTIFIED	ELECTRONIC 110V CSA CERTIFIED	BURNER SIZE	GAS INLET	BTU
18" Pan Kit - A	OPT-BFP18RSS	OPT-BFP18RSSFSML	OPT-BFP18RSSFSEN	OPT-BFP18RSSE12	OPT-BFP18RSSE110	8"	½"	50,000
18" Pan Kit - B	OPT-BFP182RSS	OPT-BFP182RSSFSML	OPT-BFP182RSSFSEN	OPT-BFP182RSSE12	OPT-BFP182RSSE110	12"	½"	75,000
24" Pan Kit	OPT-BFP24RSS	OPT-BFP24RSSFSML	OPT-BFP24RSSFSEN	OPT-BFP24RSSE12	OPT-BFP24RSSE110	18"	½"	110,000
30" Pan Kit	OPT-BFP30RSS	N/A	OPT-BFP30RSSFSEN	OPT-BFP30RSSE12	OPT-BFP30RSSE110	24"	¾"	145,000
36" Pan Kit	OPT-BFP36RSS	N/A	N/A	OPT-BFP36RSSE12	OPT-BFP36RSSE110	30"	¾"	180,000
48" Pan Kit	OPT-BFP48RSS	N/A	N/A	OPT-BFP48RSSE12	OPT-BFP48RSSE110	36"	¾"	220,000
60" Pan Kit	OPT-BFP60RSS	N/A	N/A	OPT-BFP60RSSE12	OPT-BFP60RSSE110	48"	¾"	385,000



## Round Flat Pan & SS Round Bullet Burner

ITEM	PAN & BURNER ONLY	FLAME SENSE MATCH LIT CERTIFIED	FLAME SENSE W/ SPARK IGNITION	ELECTRONIC 12V CSA CERTIFIED	ELECTRONIC 110V CSA CERTIFIED	BURNER SIZE	GAS INLET	BTU
18" Pan Kit - A	OPT-BFP18RDSS	OPT-BFP18RDSSFSML	OPT-BFP18RDSSFSEN	OPT-BFP18RDSSE12	OPT-BFP18RDSSE110	8"	½"	65,000
18" Pan Kit - B	OPT-BFP182RDSS	OPT-BFP182RDSSFSML	OPT-BFP182RDSSFSEN	OPT-BFP182RDSSE12	OPT-BFP182RDSSE110	12"	½"	100,000
24" Pan Kit	OPT-BFP24RDSS	OPT-BFP24RDSSFSML	OPT-BFP24RDSSFSEN	OPT-BFP24RDSSE12	OPT-BFP24RDSSE110	18" (2R)	½"	225,000
30" Pan Kit	OPT-BFP30RDSS	N/A	OPT-BFP30RDSSFSEN	OPT-BFP30RDSSE12	OPT-BFP30RDSSE110	24" (2R)	¾"	275,000
36" Pan Kit	OPT-BFP36RDSS	N/A	N/A	OPT-BFP36RDSSE12	OPT-BFP36RDSSE110	30" (3R)	¾"	460,000
48" Pan Kit	OPT-BFP48RDSS	N/A	N/A	OPT-BFP48RDSSE12	OPT-BFP48RDSSE110	36" (3R)	¾"	525,000
60" Pan Kit	OPT-BFP60RDSS	N/A	N/A	OPT-BFP60RDSSE12	OPT-BFP60RDSSE110	48" (4R, M)	¾"	850,000



# FLAT PAN SS BULLET BURNER KITS

PATENTED DESIGN

LIFETIME WARRANTY ON ALL BURNERS

The Patented Bullet Burner's eliminate the need for an additional LP air mixer. Suitable for either natural gas or liquid propane applications. Electronic ignition systems require 10" clearance below the pan. 110V Ignition System Kits use a 3-prong grounded plug.

**BURNER SIZE GUIDE:** M = Double Inlet and uses manifold that adds 5" in height below the pan ; 2R = 2 Rings ; 3R = 3 Rings ; 4R = 4 Rings

12V Ignition

110V Ignition

Flame Sense



## Square Flat Pan & SS Triple S Bullet Burner

ITEM	PAN & BURNER ONLY	FLAME SENSE MATCH LIT CERTIFIED	FLAME SENSE W/ SPARK IGNITION	ELECTRONIC 12V CSA CERTIFIED	ELECTRONIC 110V CSA CERTIFIED	BURNER SIZE	GAS INLET	BTU
18" Pan Kit - A	OPT-BFP18SSS	OPT-BFP18SSSFMSL	OPT-BFP18SSSFSEN	OPT-BFP18SSSE12	OPT-BFP18SSSE110	8"	½"	50,000
18" Pan Kit - B	OPT-BFP182SSS	OPT-BFP182SSSFMSL	OPT-BFP182SSSFSEN	OPT-BFP182SSSE12	OPT-BFP182SSSE110	12"	½"	75,000
24" Pan Kit	OPT-BFP24SSS	OPT-BFP24SSSFMSL	OPT-BFP24SSSFSEN	OPT-BFP24SSSE12	OPT-BFP24SSSE110	18"	½"	110,000
30" Pan Kit	OPT-BFP30SSS	N/A	OPT-BFP30SSSFSEN	OPT-BFP30SSSE12	OPT-BFP30SSSE110	24"	¾"	145,000
36" Pan Kit	OPT-BFP36SSS	N/A	N/A	OPT-BFP36SSSE12	OPT-BFP36SSSE110	30"	¾"	180,000
48" Pan Kit	OPT-BFP48SSS	N/A	N/A	OPT-BFP48SSSE12	OPT-BFP48SSSE110	36"	¾"	220,000
60" Pan Kit	OPT-BFP60SSS	N/A	N/A	OPT-BFP60SSSE12	OPT-BFP60SSSE110	48"	¾"	385,000

12V Ignition

110V Ignition

Flame Sense



## Square Flat Pan & SS Square Bullet Burner

ITEM	PAN & BURNER ONLY	FLAME SENSE MATCH LIT CERTIFIED	FLAME SENSE W/ SPARK IGNITION	ELECTRONIC 12V CSA CERTIFIED	ELECTRONIC 110V CSA CERTIFIED	BURNER SIZE	GAS INLET	BTU
18" Pan Kit - A	OPT-BFP18SQSS	OPT-BFP18SQSSFMSL	OPT-BFP18SQSSFSEN	OPT-BFP18SQSSE12	OPT-BFP18SQSSE110	8"	½"	80,000
18" Pan Kit - B	OPT-BFP182SQSS	OPT-BFP182SQSSFMSL	OPT-BFP182SQSSFSEN	OPT-BFP182SQSSE12	OPT-BFP182SQSSE110	12"	½"	120,000
24" Pan Kit	OPT-BFP24SQSS	OPT-BFP24SQSSFMSL	OPT-BFP24SQSSFSEN	OPT-BFP24SQSSE12	OPT-BFP24SQSSE110	18" (2R)	½"	280,000
30" Pan Kit	OPT-BFP30SQSS	N/A	OPT-BFP30SQSSFSEN	OPT-BFP30SQSSE12	OPT-BFP30SQSSE110	24" (2R)	¾"	340,000
36" Pan Kit	OPT-BFP36SQSS	N/A	N/A	OPT-BFP36SQSSE12	OPT-BFP36SQSSE110	30" (3R)	¾"	565,000
48" Pan Kit	OPT-BFP48SQSS	N/A	N/A	OPT-BFP48SQSSE12	OPT-BFP48SQSSE110	36" (3R)	¾"	650,000
60" Pan Kit	OPT-BFP60SQSS	N/A	N/A	OPT-BFP60SQSSE12	OPT-BFP60SQSSE110	48" (4R, M)	¾"	1,060,000

MORE ELECTRONIC IGNITION ACCESSORIES ON PAGES 155

MORE GAS ACCESSORIES ON PAGES 158

<p>REMOTE CONTROL &amp; WIRELESS RECEIVER OPT-RC110V</p>	<p>WEATHERPROOF ON/OFF SWITCH OPT-WPS110V</p>	<p>110V EMERGENCY STOP BUTTON OPT-ESTOP</p>	<p>110V 1-HOUR DIAL TIMER OPT-DTM</p>	<p>GAS TIMER &amp; EMERGENCY STOP OPT-ESTOPTM</p>	<p>NATURAL GAS KIT OPT-NGKNG - 0-290K BTU OPT-NGKNGHC - 291K+ BTU</p>	<p>LIQUID PROPANE KIT OPT-LPKLP - 0-290K BTU OPT-LPKLPHC - 291K+ BTU</p>
--	---	---	---	---	---	--

Proudly Made In The USA

# FLAT PAN & SS BULLET BURNER KITS

PATENTED DESIGN

LIFETIME WARRANTY ON ALL BURNERS

The Patented Bullet Burner's eliminate the need for an additional LP air mixer. Suitable for either natural gas or liquid propane applications. Electronic ignition systems require 10" clearance below the pan. 110V Ignition System Kits use a 3-prong grounded plug.

**BURNER SIZE GUIDE:** M = Double Inlet and uses manifold that adds 5" in height below the pan ; 2R = 2 Rings ; 3R = 3 Rings ; 4R = 4 Rings

12V Ignition

110V Ignition

Flame Sense



## Rectangular Flat Pan & SS Linear Bullet Burner

ITEM	PAN & BURNER ONLY	FLAME SENSE MATCH LIT CERTIFIED	FLAME SENSE W/ SPARK IGNITION	ELECTRONIC 12V CSA CERTIFIED	ELECTRONIC 110V CSA CERTIFIED	BURNER SIZE	GAS INLET	BTU
24"x8" Pan Kit	OPT-BFP24RTSS	OPT-BFP24RTSSFSML	OPT-BFP24RTSSFSFN	OPT-BFP24RTSSE12	OPT-BFP24RTSSE110	18"	1/2"	40,000
36"x8" Pan Kit	OPT-BFP36RTSS	OPT-BFP36RTSSFSML	OPT-BFP36RTSSFSFN	OPT-BFP36RTSSE12	OPT-BFP36RTSSE110	30"	1/2"	60,000
48"x8" Pan Kit	OPT-BFP48RTSS	OPT-BFP48RTSSFSML	OPT-BFP48RTSSFSFN	OPT-BFP48RTSSE12	OPT-BFP48RTSSE110	42"	1/2"	85,000
60"x8" Pan Kit	OPT-BFP60RTSS	OPT-BFP60RTSSFSML	OPT-BFP60RTSSFSFN	OPT-BFP60RTSSE12	OPT-BFP60RTSSE110	48"	3/4"	110,000
72"x8" Pan Kit	OPT-BFP72RTSS	OPT-BFP72RTSSFSML	OPT-BFP72RTSSFSFN	OPT-BFP72RTSSE12	OPT-BFP72RTSSE110	60"	3/4"	135,000
84"x8" Pan Kit	OPT-BFP84RTSS	N/A	N/A	OPT-BFP84RTSSE12	OPT-BFP84RTSSE110	72"	3/4"	160,000
96"x8" Pan Kit	OPT-BFP96RTSS	N/A	N/A	OPT-BFP96RTSSE12	OPT-BFP96RTSSE110	84"	3/4"	180,000

12V Ignition

110V Ignition

Flame Sense

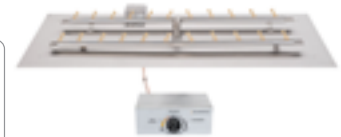

## Rectangular Flat Pan & SS 'H' Bullet Burner

ITEM	PAN & BURNER ONLY	FLAME SENSE MATCH LIT CERTIFIED	FLAME SENSE W/ SPARK IGNITION	ELECTRONIC 12V CSA CERTIFIED	ELECTRONIC 110V CSA CERTIFIED	BURNER SIZE	GAS INLET	BTU
24"x12" Pan Kit	OPT-BFP1224R5S	OPT-BFP1224R5SFSML	OPT-BFP1224R5SFSFN	OPT-BFP1224RSSE12	OPT-BFP1224RSSE110	18"x6"	1/2"	85,000
36"x12" Pan Kit	OPT-BFP1236R5S	OPT-BFP1236R5SFSML	OPT-BFP1236R5SFSFN	OPT-BFP1236RSSE12	OPT-BFP1236RSSE110	30"x6"	1/2"	110,000
48"x12" Pan Kit	OPT-BFP1248R5S	OPT-BFP1248R5SFSML	OPT-BFP1248R5SFSFN	OPT-BFP1248RSSE12	OPT-BFP1248RSSE110	42"x6"	3/4"	160,000
60"x12" Pan Kit	OPT-BFP1260R5S	N/A	N/A	OPT-BFP1260RSSE12	OPT-BFP1260RSSE110	48"x6"	3/4"	205,000
72"x12" Pan Kit	OPT-BFP1272R5S	N/A	N/A	OPT-BFP1272RSSE12	OPT-BFP1272RSSE110	60"x6" (M)	3/4"	255,000
84"x12" Pan Kit	OPT-BFP1284R5S	N/A	N/A	OPT-BFP1284RSSE12	OPT-BFP1284RSSE110	72"x6" (M)	3/4"	300,000
96"x12" Pan Kit	OPT-BFP1296R5S	N/A	N/A	OPT-BFP1296RSSE12	OPT-BFP1296RSSE110	84"x6" (M)	3/4"	350,000

12V Ignition

110V Ignition

Flame Sense



## Rectangular Flat Pan & SS Switchback Bullet Burner

ITEM	PAN & BURNER ONLY	FLAME SENSE MATCH LIT CERTIFIED	FLAME SENSE W/ SPARK IGNITION	ELECTRONIC 12V CSA CERTIFIED	ELECTRONIC 110V CSA CERTIFIED	BURNER SIZE	GAS INLET	BTU
24"x12" Pan Kit	OPT-BFP1224SBSS	OPT-BFP1224SBSSFSML	OPT-BFP1224SBSSFSFN	OPT-BFP1224SBSSSE12	OPT-BFP1224SBSSSE110	18"x6"	1/2"	70,000
36"x12" Pan Kit	OPT-BFP1236SBSS	OPT-BFP1236SBSSFSML	OPT-BFP1236SBSSFSFN	OPT-BFP1236SBSSSE12	OPT-BFP1236SBSSSE110	30"x6"	1/2"	90,000
48"x12" Pan Kit	OPT-BFP1248SBSS	OPT-BFP1248SBSSFSML	OPT-BFP1248SBSSFSFN	OPT-BFP1248SBSSSE12	OPT-BFP1248SBSSSE110	42"x6"	3/4"	125,000
60"x12" Pan Kit	OPT-BFP1260SBSS	N/A	N/A	OPT-BFP1260SBSSSE12	OPT-BFP1260SBSSSE110	48"x6"	3/4"	165,000
72"x12" Pan Kit	OPT-BFP1272SBSS	N/A	N/A	OPT-BFP1272SBSSSE12	OPT-BFP1272SBSSSE110	60"x6" (M)	3/4"	200,000
84"x12" Pan Kit	OPT-BFP1284SBSS	N/A	N/A	OPT-BFP1284SBSSSE12	OPT-BFP1284SBSSSE110	72"x6" (M)	3/4"	240,000
96"x12" Pan Kit	OPT-BFP1296SBSS	N/A	N/A	OPT-BFP1296SBSSSE12	OPT-BFP1296SBSSSE110	84"x6" (M)	3/4"	360,000

# DROP-IN PAN & SS BULLET BURNER KITS

PATENTED DESIGN

LIFETIME WARRANTY ON ALL BURNERS

Bullet Burner's eliminate the need for an additional LP air mixer. Suitable for either natural gas or liquid propane applications. Pans have 1" Lip & 2" Height. Electronic ignition requires 10" clearance below the pan. 110V Ignition System Kits use a 3-prong grounded plug.

**BURNER SIZE GUIDE:** **M** = Double Inlet and uses manifold that adds 5" in height below the pan ; **2R** = 2 Rings ; **3R** = 3 Rings ; **4R** = 4 Rings



## Round Drop In & SS Triple S Bullet Burner

ITEM	PAN & BURNER ONLY	FLAME SENSE MATCH LIT CERTIFIED	FLAME SENSE W/ SPARK IGNITION	ELECTRONIC 12V CSA CERTIFIED	ELECTRONIC 110V CSA CERTIFIED	BURNER SIZE	GAS INLET	BTU
13" Pan Kit	OPT-BP13RDSS	OPT-BP13RDSSFML	OPT-BP13RDSSFSEN	OPT-BP13RDSSE12	OPT-BP13RDSSE110	8"	½"	50,000
19" Pan Kit	OPT-BP19RDSS	OPT-BP19RDSSFML	OPT-BP19RDSSFSEN	OPT-BP19RDSSE12	OPT-BP19RDSSE110	12"	½"	75,000
25" Pan Kit	OPT-BP25RDSS	OPT-BP25RDSSFML	OPT-BP25RDSSFSEN	OPT-BP25RDSSE12	OPT-BP25RDSSE110	18"	½"	110,000
31" Pan Kit	OPT-BP31RDSS	N/A	N/A	OPT-BP31RDSSE12	OPT-BP31RDSSE110	24"	¾"	145,000
37" Pan Kit	OPT-BP37RDSS	N/A	N/A	OPT-BP37RDSSE12	OPT-BP37RDSSE110	30"	¾"	180,000
43" Pan Kit	OPT-BP43RDSS	N/A	N/A	OPT-BP43RDSSE12	OPT-BP43RDSSE110	36"	¾"	220,000



## Round Drop In & SS Round Bullet Burner

ITEM	PAN & BURNER ONLY	FLAME SENSE MATCH LIT CERTIFIED	FLAME SENSE W/ SPARK IGNITION	ELECTRONIC 12V CSA CERTIFIED	ELECTRONIC 110V CSA CERTIFIED	BURNER SIZE	GAS INLET	BTU
13" Pan Kit	OPT-BP13RRSS	OPT-BP13RRSSFML	OPT-BP13RRSSFSEN	OPT-BP13RRSSE12	OPT-BP13RRSSE110	8"	½"	65,000
19" Pan Kit	OPT-BP19RRSS	OPT-BP19RRSSFML	OPT-BP19RRSSFSEN	OPT-BP19RRSSE12	OPT-BP19RRSSE110	12"	½"	100,000
25" Pan Kit	OPT-BP25RRSS	OPT-BP25RRSSFML	OPT-BP25RRSSFSEN	OPT-BP25RRSSE12	OPT-BP25RRSSE110	18" (2R)	½"	225,000
31" Pan Kit	OPT-BP31RRSS	N/A	N/A	OPT-BP31RRSSE12	OPT-BP31RRSSE110	24" (2R)	¾"	275,000
37" Pan Kit	OPT-BP37RRSS	N/A	N/A	OPT-BP37RRSSE12	OPT-BP37RRSSE110	30" (3R)	¾"	460,000
43" Pan Kit	OPT-BP43RRSS	N/A	N/A	OPT-BP43RRSSE12	OPT-BP43RRSSE110	36" (3R)	¾"	525,000

Proudly Made In The USA

# DROP-IN PAN BRASS BULLET BURNER KITS

PATENTED DESIGN

LIFETIME WARRANTY ON ALL BURNERS

Bullet Burner's eliminate the need for an additional LP air mixer. Suitable for either natural gas or liquid propane applications. Pans have 1" Lip & 2" Height. Electronic ignition requires 10" clearance below the pan. 110V Ignition System Kits use a 3-prong grounded plug.

**BURNER SIZE GUIDE:** **M** = Double Inlet and uses manifold that adds 5" in height below the pan ; **2R** = 2 Rings ; **3R** = 3 Rings ; **4R** = 4 Rings



## Square Drop In & SS Triple S Bullet Burner

ITEM	PAN & BURNER ONLY	FLAME SENSE MATCH LIT CERTIFIED	FLAME SENSE W/ SPARK IGNITION	ELECTRONIC 12V CSA CERTIFIED	ELECTRONIC 110V CSA CERTIFIED	BURNER SIZE	GAS INLET	BTU
12" Pan Kit	OPT-BP12SDSS	OPT-BP12SDSSFSML	OPT-BP12SDSSFSEN	OPT-BP12SDSSE12	OPT-BP12SDSSE110	8"	½"	50,000
18" Pan Kit	OPT-BP18SDSS	OPT-BP18SDSSFSML	OPT-BP18SDSSFSEN	OPT-BP18SDSSE12	OPT-BP18SDSSE110	12"	½"	75,000
24" Pan Kit	OPT-BP24SDSS	OPT-BP24SDSSFSML	OPT-BP24SDSSFSEN	OPT-BP24SDSSE12	OPT-BP24SDSSE110	18"	½"	110,000
30" Pan Kit	OPT-BP30SDSS	N/A	OPT-BP30SDSSFSEN	OPT-BP30SDSSE12	OPT-BP30SDSSE110	24"	¾"	145,000
36" Pan Kit	OPT-BP36SDSS	N/A	N/A	OPT-BP36SDSSE12	OPT-BP36SDSSE110	30"	¾"	180,000
48" Pan Kit	OPT-BP48SDSS	N/A	N/A	OPT-BP48SDSSE12	OPT-BP48SDSSE110	36"	¾"	220,000



## Square Drop In & SS Square Bullet Burner

ITEM	PAN & BURNER ONLY	FLAME SENSE MATCH LIT CERTIFIED	FLAME SENSE W/ SPARK IGNITION	ELECTRONIC 12V CSA CERTIFIED	ELECTRONIC 110V CSA CERTIFIED	BURNER SIZE	GAS INLET	BTU
12" Pan Kit	OPT-BP12SQDSS	OPT-BP12SQDSSFSML	OPT-BP12SQDSSFSEN	OPT-BP12SQDSSE12	OPT-BP12SQDSSE110	8"	½"	65,000
18" Pan Kit	OPT-BP18SQDSS	OPT-BP18SQDSSFSML	OPT-BP18SQDSSFSEN	OPT-BP18SQDSSE12	OPT-BP18SQDSSE110	12"	½"	100,000
24" Pan Kit	OPT-BP24SQDSS	OPT-BP24SQDSSFSML	OPT-BP24SQDSSFSEN	OPT-BP24SQDSSE12	OPT-BP24SQDSSE110	18" (2R)	½"	225,000
30" Pan Kit	OPT-BP30SQDSS	N/A	OPT-BP30SQDSSFSEN	OPT-BP30SQDSSE12	OPT-BP30SQDSSE110	24" (2R)	¾"	275,000
36" Pan Kit	OPT-BP36SQDSS	N/A	N/A	OPT-BP36SQDSSE12	OPT-BP36SQDSSE110	30" (3R)	¾"	460,000
48" Pan Kit	OPT-BP48SQDSS	N/A	N/A	OPT-BP48SQDSSE12	OPT-BP48SQDSSE110	36" (3R)	¾"	525,000

# DROP-IN PAN BRASS BULLET BURNER KITS

PATENTED DESIGN

LIFETIME WARRANTY ON ALL BURNERS

Bullet Burner's eliminate the need for an additional LP air mixer. Suitable for either natural gas or liquid propane applications. Pans have 1" Lip & 2" Height. Electronic ignition requires 10" clearance below the pan. 110V Ignition System Kits use a 3-prong grounded plug.

**BURNER SIZE GUIDE:** M = Double Inlet and uses manifold that adds 5" in height below the pan ; 2R = 2 Rings ; 3R = 3 Rings ; 4R = 4 Rings



## Rectangular Drop In & SS Linear Bullet Burner

ITEM	PAN & BURNER ONLY	FLAME SENSE MATCH LIT CERTIFIED	FLAME SENSE W/ SPARK IGNITION	ELECTRONIC 12V CSA CERTIFIED	ELECTRONIC 110V CSA CERTIFIED	BURNER SIZE	GAS INLET	BTU
24"x8" Pan Kit	OPT-BP824RDSS	OPT-BP824RDSSFSML	OPT-BP824RDSSFSSEN	OPT-BP824RDSSSE12	OPT-BP824RDSSSE110	18"	½"	40,000
36"x8" Pan Kit	OPT-BP836RDSS	OPT-BP836RDSSFSML	OPT-BP836RDSSFSSEN	OPT-BP836RDSSSE12	OPT-BP836RDSSSE110	30"	½"	50,000
48"x8" Pan Kit	OPT-BP848RDSS	OPT-BP848RDSSFSML	OPT-BP848RDSSFSSEN	OPT-BP848RDSSSE12	OPT-BP848RDSSSE110	42"	½"	75,000
60"x8" Pan Kit	OPT-BP860RDSS	OPT-BP860RDSSFSML	OPT-BP860RDSSFSSEN	OPT-BP860RDSSSE12	OPT-BP860RDSSSE110	48"	½"	100,000
72"x8" Pan Kit	OPT-BP872RDSS	OPT-BP872RDSSFSML	OPT-BP872RDSSFSSEN	OPT-BP872RDSSSE12	OPT-BP872RDSSSE110	60"	¾"	120,000
84"x8" Pan Kit	OPT-BP884RDSS	N/A	N/A	OPT-BP884RDSSSE12	OPT-BP884RDSSSE110	72"	¾"	145,000
96"x8" Pan Kit	OPT-BP896RDSS	N/A	N/A	OPT-BP896RDSSSE12	OPT-BP896RDSSSE110	84"	¾"	170,000



## Rectangular Drop In & SS 'H' Bullet Burner

ITEM	PAN & BURNER ONLY	FLAME SENSE MATCH LIT CERTIFIED	FLAME SENSE W/ SPARK IGNITION	ELECTRONIC 12V CSA CERTIFIED	ELECTRONIC 110V CSA CERTIFIED	BURNER SIZE	GAS INLET	BTU
24"x12" Pan Kit	OPT-BP1224RDSS	OPT-BP1224RDSSFSML	OPT-BP1224RDSSFSSEN	OPT-BP1224RDSSSE12	OPT-BP1224RDSSSE110	18"x6"	½"	85,000
36"x12" Pan Kit	OPT-BP1236RDSS	OPT-BP1236RDSSFSML	OPT-BP1236RDSSFSSEN	OPT-BP1236RDSSSE12	OPT-BP1236RDSSSE110	24"x6"	½"	110,000
48"x12" Pan Kit	OPT-BP1248RDSS	OPT-BP1248RDSSFSML	OPT-BP1248RDSSFSSEN	OPT-BP1248RDSSSE12	OPT-BP1248RDSSSE110	42"x6"	¾"	160,000
60"x12" Pan Kit	OPT-BP1260RDSS	N/A	N/A	OPT-BP1260RDSSSE12	OPT-BP1260RDSSSE110	48"x6"	¾"	205,000
72"x12" Pan Kit	OPT-BP1272RDSS	N/A	N/A	OPT-BP1272RDSSSE12	OPT-BP1272RDSSSE110	60"x6" (M)	¾"	255,000
84"x12" Pan Kit	OPT-BP1284RDSS	N/A	N/A	OPT-BP1284RDSSSE12	OPT-BP1284RDSSSE110	72"x6" (M)	¾"	300,000
96"x12" Pan Kit	OPT-BP1296RDSS	N/A	N/A	OPT-BP1296RDSSSE12	OPT-BP1296RDSSSE110	84"x6" (M)	¾"	350,000



## Rectangular Drop In & SS Switchback Bullet Burner

ITEM	PAN & BURNER ONLY	FLAME SENSE MATCH LIT CERTIFIED	FLAME SENSE W/ SPARK IGNITION	ELECTRONIC 12V CSA CERTIFIED	ELECTRONIC 110V CSA CERTIFIED	BURNER SIZE	GAS INLET	BTU
24"x12" Pan Kit	OPT-BP1224SBDSS	OPT-BP1224SBDSSFSML	OPT-BP1224SBDSSFSSEN	OPT-BP1224SBDSSSE12	OPT-BP1224SBDSSSE110	18"x6"	½"	70,000
36"x12" Pan Kit	OPT-BP1236SBDSS	OPT-BP1236SBDSSFSML	OPT-BP1236SBDSSFSSEN	OPT-BP1236SBDSSSE12	OPT-BP1236SBDSSSE110	30"x6"	½"	90,000
48"x12" Pan Kit	OPT-BP1248SBDSS	OPT-BP1248SBDSSFSML	OPT-BP1248SBDSSFSSEN	OPT-BP1248SBDSSSE12	OPT-BP1248SBDSSSE110	42"x6"	¾"	125,000
60"x12" Pan Kit	OPT-BP1260SBDSS	N/A	N/A	OPT-BP1260SBDSSSE12	OPT-BP1260SBDSSSE110	48"x6"	¾"	165,000
72"x12" Pan Kit	OPT-BP1272SBDSS	N/A	N/A	OPT-BP1272SBDSSSE12	OPT-BP1272SBDSSSE110	60"x6" (M)	¾"	200,000
84"x12" Pan Kit	OPT-BP1284SBDSS	N/A	N/A	OPT-BP1284SBDSSSE12	OPT-BP1284SBDSSSE110	72"x6" (M)	¾"	240,000
96"x12" Pan Kit	OPT-BP1296SBDSS	N/A	N/A	OPT-BP1296SBDSSSE12	OPT-BP1296SBDSSSE110	84"x6" (M)	¾"	360,000

Proudly Made In The USA

Suitable for either natural gas or liquid propane applications. Electronic ignition systems require 10" clearance below the pan. 110V Ignition System Kits use a 3-prong grounded plug.

**BURNER SIZE GUIDE:** **M** = Double Inlet and uses manifold that adds 5" in height below the pan ; **2R** = 2 Rings ; **3R** = 3 Rings ; **4R** = 4 Rings



## Round Flat Pan & Round SS Burner

ITEM	PAN & BURNER ONLY	FLAME SENSE MATCH LIT CERTIFIED	FLAME SENSE W/ SPARK IGNITION	ELECTRONIC 12V CSA CERTIFIED	ELECTRONIC 110V CSA CERTIFIED	BURNER SIZE	GAS INLET	BTU
12" Pan Kit	OPT-110012BP	OPT-110012BPFMSML	OPT-110012BPFSEN	OPT-110012BPE12	OPT-110012BPE110	6"	½"	35,000
18" Pan Kit	OPT-110018BP	OPT-110018BPFMSML	OPT-110018BPFSEN	OPT-110018BPE12	OPT-110018BPE110	12"	½"	65,000
24" Pan Kit	OPT-110024BP	OPT-110024BPFMSML	OPT-110024BPFSEN	OPT-110024BPE12	OPT-110024BPE110	18" (2R)	½"	160,000
30" Pan Kit	OPT-110030BP	N/A	OPT-110030BPFSEN	OPT-110030BPE12	OPT-110030BPE110	24" (2R)	½"	190,000
36" Pan Kit	OPT-110036BP	N/A	N/A	OPT-110036BPE12	OPT-110036BPE110	30" (3R)	¾"	330,000
42" Pan Kit	OPT-110042BP	N/A	N/A	OPT-110042BPE12	OPT-110042BPE110	36" (3R)	¾"	380,000
48" Pan Kit	OPT-110048BP	N/A	N/A	OPT-110048BPE12	OPT-110048BPE110	36" (3R)	¾"	380,000



## Round Flat Pan & SS Lotus Burner

ITEM	PAN & BURNER ONLY	FLAME SENSE MATCH LIT CERTIFIED	FLAME SENSE W/ SPARK IGNITION	ELECTRONIC 12V CSA CERTIFIED	ELECTRONIC 110V CSA CERTIFIED	BURNER SIZE	GAS INLET	BTU
18" Pan Kit	OPT-FRLB18	OPT-FRLB18FSML	OPT-FRLB18FSEN	OPT-FRLB18E12	OPT-FRLB18E110	12"	½"	60,000
24" Pan Kit	OPT-FRLB24	OPT-FRLB24FSML	OPT-FRLB24FSEN	OPT-FRLB24E12	OPT-FRLB24E110	18"	½"	120,000
30" Pan Kit	OPT-FRLB30	N/A	OPT-FRLB30FSEN	OPT-FRLB30E12	OPT-FRLB30E110	24"	½"	190,000
36" Pan Kit	OPT-FRLB36	N/A	N/A	OPT-FRLB36E12	OPT-FRLB36E110	30"	¾"	260,000
42" Pan Kit	OPT-FRLB42	N/A	N/A	OPT-FRLB42E12	OPT-FRLB42E110	36"	¾"	340,000
48" Pan Kit	OPT-FRLB48	N/A	N/A	OPT-FRLB48E12	OPT-FRLB48E110	36"	¾"	340,000

Suitable for either natural gas or liquid propane applications. Electronic ignition systems require 10" clearance below the pan. 110V Ignition System Kits use a 3-prong grounded plug.

**BURNER SIZE GUIDE:** **M** = Double Inlet and uses manifold that adds 5" in height below the pan ; **2R** = 2 Rings ; **3R** = 3 Rings ; **4R** = 4 Rings



## Square Flat Pan & Square SS Burner

ITEM	PAN & BURNER ONLY	FLAME SENSE MATCH LIT CERTIFIED	FLAME SENSE W/ SPARK IGNITION	ELECTRONIC 12V CSA CERTIFIED	ELECTRONIC 110V CSA CERTIFIED	BURNER SIZE	GAS INLET	BTU
16.5" Pan Kit	OPT-999BP16	OPT-999BP16FSML	OPT-999BP16FSEN	OPT-999BP16E12	OPT-999BP16E110	12"	½"	65,000
18" Pan Kit	OPT-999BP18	OPT-999BP18FSML	OPT-999BP18FSEN	OPT-999BP18E12	OPT-999BP18E110	12"	½"	90,000
24" Pan Kit	OPT-999BP24	OPT-999BP24FSML	OPT-999BP24FSEN	OPT-999BP24E12	OPT-999BP24E110	18" (2R)	½"	160,000
30" Pan Kit	OPT-999BP30	N/A	OPT-999BP30FSEN	OPT-999BP30E12	OPT-999BP30E110	24" (2R)	½"	190,000
36" Pan Kit	OPT-999BP36	N/A	N/A	OPT-999BP36E12	OPT-999BP36E110	30" (3R)	¾"	310,000
48" Pan Kit	OPT-999BP48	N/A	N/A	OPT-999BP48E12	OPT-999BP48E110	36" (3R)	¾"	375,000



## Square Flat Pan & SS Lotus Burner

ITEM	PAN & BURNER ONLY	FLAME SENSE MATCH LIT CERTIFIED	FLAME SENSE W/ SPARK IGNITION	ELECTRONIC 12V CSA CERTIFIED	ELECTRONIC 110V CSA CERTIFIED	BURNER SIZE	GAS INLET	BTU
16.5" Pan Kit	OPT-FSLB16	OPT-FSLB16FSML	OPT-FSLB16FSEN	OPT-FSLB16E12	OPT-FSLB16E110	12"	½"	90,000
18" Pan Kit	OPT-FSLB18	OPT-FSLB18FSML	OPT-FSLB18FSEN	OPT-FSLB18E12	OPT-FSLB18E110	12"	½"	90,000
24" Pan Kit	OPT-FSLB24	OPT-FSLB24FSML	OPT-FSLB24FSEN	OPT-FSLB24E12	OPT-FSLB24E110	18"	½"	115,000
30" Pan Kit	OPT-FSLB30	N/A	OPT-FSLB30FSEN	OPT-FSLB30E12	OPT-FSLB30E110	24"	½"	175,000
36" Pan Kit	OPT-FSLB36	N/A	N/A	OPT-FSLB36E12	OPT-FSLB36E110	30"	¾"	220,000
48" Pan Kit	OPT-FSLB48	N/A	N/A	OPT-FSLB48E12	OPT-FSLB48E110	36"	¾"	265,000

Suitable for either natural gas or liquid propane applications. Electronic ignition systems require 10" clearance below the pan. 110V Ignition System Kits use a 3-prong grounded plug.

**BURNER SIZE GUIDE:** **M** = Double Inlet and uses manifold that adds 5" in height below the pan ; **2R** = 2 Rings ; **3R** = 3 Rings ; **4R** = 4 Rings



## Rectangular Flat Pan & SS Linear Burner

ITEM	PAN & BURNER ONLY	FLAME SENSE MATCH LIT CERTIFIED	FLAME SENSE IGNITION	ELECTRONIC 12V CSA CERTIFIED	ELECTRONIC 110V CSA CERTIFIED	BURNER SIZE	GAS INLET	BTU
24" x 6" Pan Kit	OPT-REFS624	OPT-REFS624FSML	OPT-REFS624FSEN	OPT-REFS624E12	OPT-REFS624E110	18"	½"	30,000
30" x 6" Pan Kit	OPT-REFS630	OPT-REFS630FSML	OPT-REFS630FSEN	OPT-REFS630E12	OPT-REFS630E110	24"	½"	40,000
36" x 6" Pan Kit	OPT-REFS636	OPT-REFS636FSML	OPT-REFS636FSEN	OPT-REFS636E12	OPT-REFS636E110	30"	½"	50,000
42" x 6" Pan Kit	OPT-REFS642	OPT-REFS642FSML	OPT-REFS642FSEN	OPT-REFS642E12	OPT-REFS642E110	36"	½"	60,000
48" x 6" Pan Kit	OPT-REFS648	OPT-REFS648FSML	OPT-REFS648FSEN	OPT-REFS648E12	OPT-REFS648E110	42"	½"	70,000
60" x 6" Pan Kit	OPT-REFS660	OPT-REFS660FSML	OPT-REFS660FSEN	OPT-REFS660E12	OPT-REFS660E110	48"	½"	80,000
72" x 6" Pan Kit	OPT-REFS672	OPT-REFS672FSML	OPT-REFS672FSEN	OPT-REFS672E12	OPT-REFS672E110	60"	½"	100,000
84" x 6" Pan Kit	OPT-REFS684	N/A	N/A	OPT-REFS684E12	OPT-REFS684E110	72"	½"	120,000
96" x 6" Pan Kit	OPT-REFS696	N/A	N/A	OPT-REFS696E12	OPT-REFS696E110	84"	¾"	140,000
24" x 8" Pan Kit	OPT-REFS824	OPT-REFS824FSML	OPT-REFS824FSEN	OPT-REFS824E12	OPT-REFS824E110	18"	½"	30,000
30" x 8" Pan Kit	OPT-REFS830	OPT-REFS830FSML	OPT-REFS830FSEN	OPT-REFS830E12	OPT-REFS830E110	24"	½"	40,000
36" x 8" Pan Kit	OPT-REFS836	OPT-REFS836FSML	OPT-REFS836FSEN	OPT-REFS836E12	OPT-REFS836E110	30"	½"	50,000
42" x 8" Pan Kit	OPT-REFS842	OPT-REFS842FSML	OPT-REFS842FSEN	OPT-REFS842E12	OPT-REFS842E110	36"	½"	60,000
48" x 8" Pan Kit	OPT-REFS848	OPT-REFS848FSML	OPT-REFS848FSEN	OPT-REFS848E12	OPT-REFS848E110	42"	½"	70,000
60" x 8" Pan Kit	OPT-REFS860	OPT-REFS860FSML	OPT-REFS860FSEN	OPT-REFS860E12	OPT-REFS860E110	48"	½"	80,000
72" x 8" Pan Kit	OPT-REFS872	OPT-REFS872FSML	OPT-REFS872FSEN	OPT-REFS872E12	OPT-REFS872E110	60"	½"	100,000
84" x 8" Pan Kit	OPT-REFS884	N/A	N/A	OPT-REFS884E12	OPT-REFS884E110	72"	½"	120,000
96" x 8" Pan Kit	OPT-REFS896	N/A	N/A	OPT-REFS896E12	OPT-REFS896E110	84"	¾"	140,000



## Rectangular Flat Pan & SS 'H' Burner

ITEM	PAN & BURNER ONLY	FLAME SENSE MATCH LIT CERTIFIED	FLAME SENSE IGNITION	ELECTRONIC 12V CSA CERTIFIED	ELECTRONIC 110V CSA CERTIFIED	BURNER SIZE	GAS INLET	BTU
24" x 12" Pan Kit	OPT-REFD1224	OPT-REFD1224FSML	OPT-REFD1224FSEN	OPT-REFD1224E12	OPT-REFD1224E110	18" x 6"	½"	70,000
30" x 12" Pan Kit	OPT-REFD1230	OPT-REFD1230FSML	OPT-REFD1230FSEN	OPT-REFD1230E12	OPT-REFD1230E110	24" x 6"	½"	90,000
36" x 12" Pan Kit	OPT-REFD1236	OPT-REFD1236FSML	OPT-REFD1236FSEN	OPT-REFD1236E12	OPT-REFD1236E110	30" x 6"	½"	110,000
42" x 12" Pan Kit	OPT-REFD1242	OPT-REFD1242FSML	OPT-REFD1242FSEN	OPT-REFD1242E12	OPT-REFD1242E110	36" x 6"	½"	130,000
48" x 12" Pan Kit	OPT-REFD1248	N/A	N/A	OPT-REFD1248E12	OPT-REFD1248E110	42" x 6"	½"	150,000
60" x 12" Pan Kit	OPT-REFD1260	N/A	N/A	OPT-REFD1260E12	OPT-REFD1260E110	48" x 6"	½"	170,000
72" x 12" Pan Kit	OPT-REFD1272	N/A	N/A	OPT-REFD1272E12	OPT-REFD1272E110	60" x 6" (M)	¾"	210,000
84" x 12" Pan Kit	OPT-REFD1284	N/A	N/A	OPT-REFD1284E12	OPT-REFD1284E110	72" x 6" (M)	¾"	250,000
96" x 12" Pan Kit	OPT-REFD1296	N/A	N/A	OPT-REFD1296E12	OPT-REFD1296E110	84" x 6" (M)	¾"	290,000
24" x 18" Pan Kit	OPT-REFD1824	OPT-REFD1824FSML	OPT-REFD1824FSEN	OPT-REFD1824E12	OPT-REFD1824E110	18" x 12"	½"	70,000
30" x 18" Pan Kit	OPT-REFD1830	OPT-REFD1830FSML	OPT-REFD1830FSEN	OPT-REFD1830E12	OPT-REFD1830E110	24" x 12"	½"	90,000
36" x 18" Pan Kit	OPT-REFD1836	OPT-REFD1836FSML	OPT-REFD1836FSEN	OPT-REFD1836E12	OPT-REFD1836E110	30" x 12"	½"	110,000
42" x 18" Pan Kit	OPT-REFD1842	OPT-REFD1842FSML	OPT-REFD1842FSEN	OPT-REFD1842E12	OPT-REFD1842E110	36" x 12"	½"	130,000
48" x 18" Pan Kit	OPT-REFD1848	N/A	N/A	OPT-REFD1848E12	OPT-REFD1848E110	42" x 12"	½"	150,000
60" x 18" Pan Kit	OPT-REFD1860	N/A	N/A	OPT-REFD1860E12	OPT-REFD1860E110	48" x 12"	½"	170,000
72" x 18" Pan Kit	OPT-REFD1872	N/A	N/A	OPT-REFD1872E12	OPT-REFD1872E110	60" x 12" (M)	¾"	210,000
84" x 18" Pan Kit	OPT-REFD1884	N/A	N/A	OPT-REFD1884E12	OPT-REFD1884E110	72" x 12" (M)	¾"	250,000
96" x 18" Pan Kit	OPT-REFD1896	N/A	N/A	OPT-REFD1896E12	OPT-REFD1896E110	84" x 12" (M)	¾"	290,000



# FLAT PAN & SS BURNER KITS

LIFETIME WARRANTY ON ALL BURNERS

Suitable for either natural gas or liquid propane applications. Electronic ignition systems require 10" clearance below the pan. 110V Ignition System Kits use a 3-prong grounded plug.

**BURNER SIZE GUIDE:** **M** = Double Inlet and uses manifold that adds 5" in height below the pan ; **2R** = 2 Rings ; **3R** = 3 Rings ; **4R** = 4 Rings

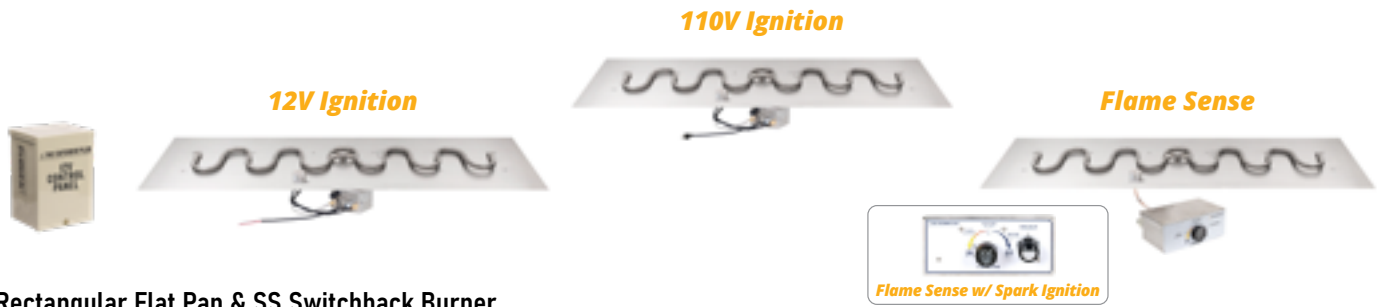

## Rectangular Flat Pan & SS Switchback Burner

ITEM	PAN & BURNER ONLY	FLAME SENSE MATCH LIT CERTIFIED	FLAME SENSE W/ SPARK IGNITION	ELECTRONIC 12V CSA CERTIFIED	ELECTRONIC 110V CSA CERTIFIED	BURNER SIZE	GAS INLET	BTU
24" x 12" Pan Kit	OPT-RFSB1224	OPT-RFSB1224FSML	OPT-RFSB1224FSEN	OPT-RFSB1224E12	OPT-RFSB1224E110	18" x 6"	½"	60,000
30" x 12" Pan Kit	OPT-RFSB1230	OPT-RFSB1230FSML	OPT-RFSB1230FSEN	OPT-RFSB1230E12	OPT-RFSB1230E110	24" x 6"	½"	75,000
36" x 12" Pan Kit	OPT-RFSB1236	OPT-RFSB1236FSML	OPT-RFSB1236FSEN	OPT-RFSB1236E12	OPT-RFSB1236E110	30" x 6"	½"	90,000
42" x 12" Pan Kit	OPT-RFSB1242	N/A	N/A	OPT-RFSB1242E12	OPT-RFSB1242E110	36" x 6"	½"	105,000
48" x 12" Pan Kit	OPT-RFSB1248	N/A	N/A	OPT-RFSB1248E12	OPT-RFSB1248E110	42" x 6"	½"	125,000
60" x 12" Pan Kit	OPT-RFSB1260	N/A	N/A	OPT-RFSB1260E12	OPT-RFSB1260E110	48" x 6"	½"	140,000
72" x 12" Pan Kit	OPT-RFSB1272	N/A	N/A	OPT-RFSB1272E12	OPT-RFSB1272E110	60" x 6" (M)	¾"	170,000
84" x 12" Pan Kit	OPT-RFSB1284	N/A	N/A	OPT-RFSB1284E12	OPT-RFSB1284E110	72" x 6" (M)	¾"	200,000
96" x 12" Pan Kit	OPT-RFSB1296	N/A	N/A	OPT-RFSB1296E12	OPT-RFSB1296E110	84" x 6" (M)	¾"	305,000
24" x 18" Pan Kit	OPT-RFSB1824	OPT-RFSB1824FSML	OPT-RFSB1824FSEN	OPT-RFSB1824E12	OPT-RFSB1824E110	18" x 12"	½"	60,000
30" x 18" Pan Kit	OPT-RFSB1830	OPT-RFSB1830FSML	OPT-RFSB1830FSEN	OPT-RFSB1830E12	OPT-RFSB1830E110	24" x 12"	½"	75,000
36" x 18" Pan Kit	OPT-RFSB1836	OPT-RFSB1836FSML	OPT-RFSB1836FSEN	OPT-RFSB1836E12	OPT-RFSB1836E110	30" x 12"	½"	90,000
42" x 18" Pan Kit	OPT-RFSB1842	OPT-RFSB1842FSML	OPT-RFSB1842FSEN	OPT-RFSB1842E12	OPT-RFSB1842E110	36" x 12"	½"	105,000
48" x 18" Pan Kit	OPT-RFSB1848	N/A	N/A	OPT-RFSB1848E12	OPT-RFSB1848E110	42" x 12"	½"	125,000
60" x 18" Pan Kit	OPT-RFSB1860	N/A	N/A	OPT-RFSB1860E12	OPT-RFSB1860E110	48" x 12"	½"	140,000
72" x 18" Pan Kit	OPT-RFSB1872	N/A	N/A	OPT-RFSB1872E12	OPT-RFSB1872E110	60" x 12" (M)	¾"	170,000
84" x 18" Pan Kit	OPT-RFSB1884	N/A	N/A	OPT-RFSB1884E12	OPT-RFSB1884E110	72" x 12" (M)	¾"	200,000
96" x 18" Pan Kit	OPT-RFSB1896	N/A	N/A	OPT-RFSB1896E12	OPT-RFSB1896E110	84" x 12" (M)	¾"	305,000



Custom Oversized Linear Pan and Burner  
Courtesy of Steele's Signature Pools, LLC, Medford, NJ, Sea Girt, NJ

# DROP IN PAN & SS BURNER KITS

 LIFETIME WARRANTY ON ALL BURNERS

Suitable for either natural gas or liquid propane applications. Pans have 1" Lip & 2" Height. Electronic ignition systems require 10" clearance below the pan. 110V Ignition System Kits use a 3-prong grounded plug.

**BURNER SIZE GUIDE:** **M** = Double Inlet and uses manifold that adds 5" in height below the pan ; **2R** = 2 Rings ; **3R** = 3 Rings ; **4R** = 4 Rings



## Round Drop In Pan & Round SS Burner

ITEM	PAN & BURNER ONLY	FLAME SENSE MATCH LIT CERTIFIED	FLAME SENSE W/ SPARK IGNITION	ELECTRONIC 12V CSA CERTIFIED	ELECTRONIC 110V CSA CERTIFIED	BURNER SIZE	GAS INLET	BTU
13" Drop In Kit	OPT-PBR13	OPT-PBR13FSML	OPT-PBR13FSEN	OPT-PBR13E12	OPT-PBR13E110	6"	½"	65,000
19" Drop In Kit	OPT-PBR19	OPT-PBR19FSML	OPT-PBR19FSEN	OPT-PBR19E12	OPT-PBR19E110	12"	½"	90,000
25" Drop In Kit	OPT-PBR25	OPT-PBR25FSML	OPT-PBR25FSEN	OPT-PBR25E12	OPT-PBR25E110	18" (2R)	½"	160,000
31" Drop In Kit	OPT-PBR31	N/A	OPT-PBR31FSEN	OPT-PBR31E12	OPT-PBR31E110	24" (2R)	½"	190,000
37" Drop In Kit	OPT-PBR37	N/A	N/A	OPT-PBR37E12	OPT-PBR37E110	30" (3R)	¾"	310,000
43" Drop In Kit	OPT-PBR43	N/A	N/A	OPT-PBR43E12	OPT-PBR43E110	36" (3R)	¾"	375,000



## Round Drop In Pan & SS Lotus Burner

ITEM	PAN & BURNER ONLY	FLAME SENSE MATCH LIT CERTIFIED	FLAME SENSE W/ SPARK IGNITION	ELECTRONIC 12V CSA CERTIFIED	ELECTRONIC 110V CSA CERTIFIED	BURNER SIZE	GAS INLET	BTU
19" Drop In Kit	OPT-PBRLF19	OPT-PBRLF19FSML	OPT-PBRLF19FSEN	OPT-PBRLF19E12	OPT-PBRLF19E110	12"	½"	90,000
25" Drop In Kit	OPT-PBRLF25	OPT-PBRLF25FSML	OPT-PBRLF25FSEN	OPT-PBRLF25E12	OPT-PBRLF25E110	18"	½"	115,000
31" Drop In Kit	OPT-PBRLF31	N/A	OPT-PBRLF31FSEN	OPT-PBRLF31E12	OPT-PBRLF31E110	24"	½"	175,000
37" Drop In Kit	OPT-PBRLF37	N/A	N/A	OPT-PBRLF37E12	OPT-PBRLF37E110	30"	¾"	220,000
43" Drop In Kit	OPT-PBRLF43	N/A	N/A	OPT-PBRLF43E12	OPT-PBRLF43E110	36"	¾"	265,000

# DROP IN PAN & SS BURNER KITS

LIFETIME WARRANTY ON ALL BURNERS

Suitable for either natural gas or liquid propane applications. Pans have 1" Lip & 2" Height. Electronic ignition systems require 10" clearance below the pan. 110V Ignition System Kits use a 3-prong grounded plug.

**BURNER SIZE GUIDE:** M = Double Inlet and uses manifold that adds 5" in height below the pan ; 2R = 2 Rings ; 3R = 3 Rings ; 4R = 4 Rings



## Square Drop In Pan & Square SS Burner

ITEM	PAN & BURNER ONLY	FLAME SENSE MATCH LIT CERTIFIED	FLAME SENSE W/ SPARK IGNITION	ELECTRONIC 12V CSA CERTIFIED	ELECTRONIC 110V CSA CERTIFIED	BURNER SIZE	GAS INLET	BTU
16.5" Drop In Kit	OPT-PBS16	OPT-PBS16FSML	OPT-PBS16FSEN	OPT-PBS16E12	OPT-PBS16E110	12"	½"	90,000
18" Drop In Kit	OPT-PBS18	OPT-PBS18FSML	OPT-PBS18FSEN	OPT-PBS18E12	OPT-PBS18E110	12"	½"	90,000
24" Drop In Kit	OPT-PBS24	OPT-PBS24FSML	OPT-PBS24FSEN	OPT-PBS24E12	OPT-PBS24E110	18" (2R)	½"	160,000
30" Drop In Kit	OPT-PBS30	N/A	OPT-PBS30FSEN	OPT-PBS30E12	OPT-PBS30E110	24" (2R)	½"	190,000
36" Drop In Kit	OPT-PBS36	N/A	N/A	OPT-PBS36E12	OPT-PBS36E110	30" (3R)	¾"	310,000
48" Drop In Kit	OPT-PBS48	N/A	N/A	OPT-PBS48E12	OPT-PBS48E110	36" (3R)	¾"	375,000



## Square Drop In Pan & SS Lotus Burner

ITEM	PAN & BURNER ONLY	FLAME SENSE MATCH LIT CERTIFIED	FLAME SENSE W/ SPARK IGNITION	ELECTRONIC 12V CSA CERTIFIED	ELECTRONIC 110V CSA CERTIFIED	BURNER SIZE	GAS INLET	BTU
16.5" Drop In Kit	OPT-PBSLF16	OPT-PBSLF16FSML	OPT-PBSLF16FSEN	OPT-PBSLF16E12	OPT-PBSLF16E110	12"	½"	90,000
18" Drop In Kit	OPT-PBSLF18	OPT-PBSLF18FSML	OPT-PBSLF18FSEN	OPT-PBSLF18E12	OPT-PBSLF18E110	12"	½"	100,000
24" Drop In Kit	OPT-PBSLF24	OPT-PBSLF24FSML	OPT-PBSLF24FSEN	OPT-PBSLF24E12	OPT-PBSLF24E110	18"	½"	160,000
30" Drop In Kit	OPT-PBSLF30	N/A	OPT-PBSLF30FSEN	OPT-PBSLF30E12	OPT-PBSLF30E110	24"	½"	190,000
36" Drop In Kit	OPT-PBSLF36	N/A	N/A	OPT-PBSLF36E12	OPT-PBSLF36E110	30"	¾"	260,000
48" Drop In Kit	OPT-PBSLF48	N/A	N/A	OPT-PBSLF48E12	OPT-PBSLF48E110	36"	¾"	350,000

Proudly Made In The USA

# DROP IN PAN & SS BURNER KITS

 LIFETIME WARRANTY ON ALL BURNERS

Suitable for either natural gas or liquid propane applications. Pans have 1" Lip & 2" Height. Electronic ignition systems require 10" clearance below the pan. 110V Ignition System Kits use a 3-prong grounded plug.

**BURNER SIZE GUIDE:** **M** = Double Inlet and uses manifold that adds 5" in height below the pan ; **2R** = 2 Rings ; **3R** = 3 Rings ; **4R** = 4 Rings



## Rectangular Drop In Pan & SS Linear Burner

ITEM	PAN & BURNER ONLY	FLAME SENSE MATCH LIT CERTIFIED	FLAME SENSE W/ SPARK IGNITION	ELECTRONIC 12V CSA CERTIFIED	ELECTRONIC 110V CSA CERTIFIED	BURNER SIZE	GAS INLET	BTU
24"x6" Rectangle	OPT-RT24	OPT-RT24FSML	OPT-RT24FSEN	OPT-RT24E12	OPT-RT24E110	18"	½"	30,000
30"x6" Rectangle	OPT-RT30	OPT-RT30FSML	OPT-RT30FSEN	OPT-RT30E12	OPT-RT30E110	24"	½"	40,000
36"x6" Rectangle	OPT-RT36	OPT-RT36FSML	OPT-RT36FSEN	OPT-RT36E12	OPT-RT36E110	30"	½"	50,000
42"x6" Rectangle	OPT-RT42	OPT-RT42FSML	OPT-RT42FSEN	OPT-RT42E12	OPT-RT42E110	36"	½"	60,000
48"x6" Rectangle	OPT-RT48	OPT-RT48FSML	OPT-RT48FSEN	OPT-RT48E12	OPT-RT48E110	42"	½"	70,000
60"x6" Rectangle	OPT-RT60	OPT-RT60FSML	OPT-RT60FSEN	OPT-RT60E12	OPT-RT60E110	48"	½"	80,000
72"x6" Rectangle	OPT-RT72	OPT-RT72FSML	OPT-RT72FSEN	OPT-RT72E12	OPT-RT72E110	60"	½"	100,000
84"x6" Rectangle	OPT-RT84	N/A	N/A	OPT-RT84E12	OPT-RT84E110	72"	¾"	120,000
96"x6" Rectangle	OPT-RT96	N/A	N/A	OPT-RT96E12	OPT-RT96E110	84"	¾"	140,000



## Rectangular Drop In Pan & SS 'H' Burner

ITEM	PAN & BURNER ONLY	FLAME SENSE MATCH LIT CERTIFIED	FLAME SENSE W/ SPARK IGNITION	ELECTRONIC 12V CSA CERTIFIED	ELECTRONIC 110V CSA CERTIFIED	BURNER SIZE	GAS INLET	BTU
24"x12" Rectangle	OPT-PB1224	OPT-PB1224FSML	OPT-PB1224FSEN	OPT-PB1224E12	OPT-PB1224E110	18" x 6"	½"	60,000
30"x12" Rectangle	OPT-PB1230	OPT-PB1230FSML	OPT-PB1230FSEN	OPT-PB1230E12	OPT-PB1230E110	24" x 6"	½"	80,000
36"x12" Rectangle	OPT-PB1236	OPT-PB1236FSML	OPT-PB1236FSEN	OPT-PB1236E12	OPT-PB1236E110	30" x 6"	½"	100,000
42"x12" Rectangle	OPT-PB1242	OPT-PB1242FSML	OPT-PB1242FSEN	OPT-PB1242E12	OPT-PB1242E110	36" x 6"	½"	120,000
48"x12" Rectangle	OPT-PB1248	N/A	N/A	OPT-PB1248E12	OPT-PB1248E110	42" x 6"	½"	140,000
60"x12" Rectangle	OPT-PB1260	N/A	N/A	OPT-PB1260E12	OPT-PB1260E110	48" x 6"	¾"	160,000
72"x12" Rectangle	OPT-PB1272	N/A	N/A	OPT-PB1272E12	OPT-PB1272E110	60" x 6"	¾"	200,000
84"x12" Rectangle	OPT-PB1284	N/A	N/A	OPT-PB1284E12	OPT-PB1284E110	72" x 6" (M)	¾"	240,000
96"x12" Rectangle	OPT-PB1296	N/A	N/A	OPT-PB1296E12	OPT-PB1296E110	84" x 6" (M)	¾"	240,000

# DROP IN PAN & SS BURNER KITS

LIFETIME WARRANTY ON ALL BURNERS

Suitable for either natural gas or liquid propane applications. Pans have 1" Lip & 2" Height. Electronic ignition systems require 10" clearance below the pan. 110V Ignition System Kits use a 3-prong grounded plug.

**BURNER SIZE GUIDE:** M = Double Inlet and uses manifold that adds 5" in height below the pan ; 2R = 2 Rings ; 3R = 3 Rings ; 4R = 4 Rings

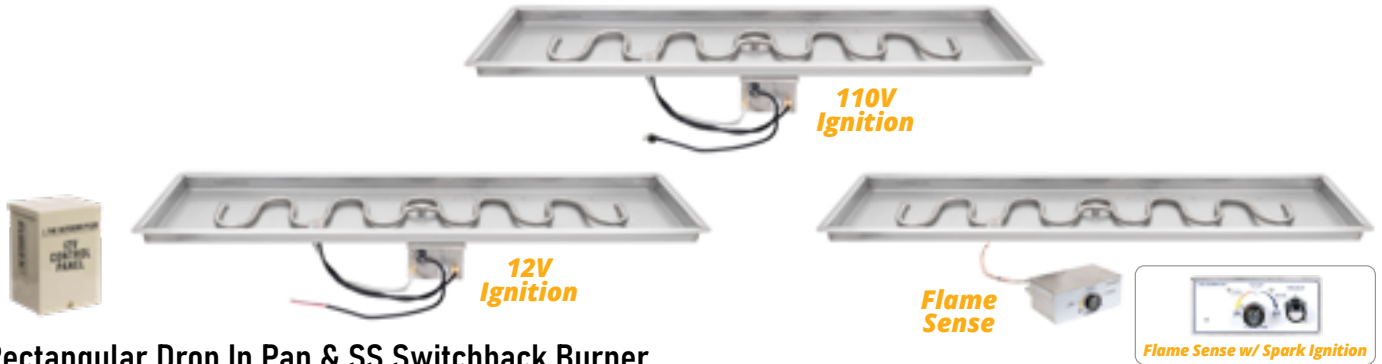

## Rectangular Drop In Pan & SS Switchback Burner

ITEM	PAN & BURNER ONLY	FLAME SENSE MATCH LIT CERTIFIED	FLAME SENSE W/ SPARK IGNITION	ELECTRONIC 12V CSA CERTIFIED	ELECTRONIC 110V CSA CERTIFIED	BURNER SIZE	GAS INLET	BTU
24"x12" Rectangle	OPT-PBSB1224	OPT-PBSB1224FSML	OPT-PBSB1224FSEN	OPT-PBSB1224E12	OPT-PBSB1224E110	18" x 6"	½"	60,000
30"x12" Rectangle	OPT-PBSB1230	OPT-PBSB1230FSML	OPT-PBSB1230FSEN	OPT-PBSB1230E12	OPT-PBSB1230E110	24" x 6"	½"	80,000
36"x12" Rectangle	OPT-PBSB1236	OPT-PBSB1236FSML	OPT-PBSB1236FSEN	OPT-PBSB1236E12	OPT-PBSB1236E110	30" x 6"	½"	100,000
42"x12" Rectangle	OPT-PBSB1242	OPT-PBSB1242FSML	OPT-PBSB1242FSEN	OPT-PBSB1242E12	OPT-PBSB1242E110	36" x 6"	½"	120,000
48"x12" Rectangle	OPT-PBSB1248	N/A	N/A	OPT-PBSB1248E12	OPT-PBSB1248E110	42" x 6"	½"	140,000
60"x12" Rectangle	OPT-PBSB1260	N/A	N/A	OPT-PBSB1260E12	OPT-PBSB1260E110	48" x 6"	¾"	160,000
72"x12" Rectangle	OPT-PBSB1272	N/A	N/A	OPT-PBSB1272E12	OPT-PBSB1272E110	60" x 6" (M)	¾"	200,000
84"x12" Rectangle	OPT-PBSB1284	N/A	N/A	OPT-PBSB1284E12	OPT-PBSB1284E110	72" x 6" (M)	¾"	240,000
96"x12" Rectangle	OPT-PBSB1296	N/A	N/A	OPT-PBSB1296E12	OPT-PBSB1296E110	84" x 6" (M)	¾"	240,000

MORE ELECTRONIC IGNITION ACCESSORIES ON PAGES 155

MORE GAS ACCESSORIES ON PAGES 158

<p><b>REMOTE CONTROL &amp; WIRELESS RECEIVER</b> OPT-RC110V</p>	<p><b>WEATHERPROOF ON/OFF SWITCH</b> OPT-WPS110V</p>	<p><b>110V EMERGENCY STOP BUTTON</b> OPT-ESTOP</p>	<p><b>110V 1-HOUR DIAL TIMER</b> OPT-DTM</p>	<p><b>GAS TIMER &amp; EMERGENCY STOP</b> OPT-ESTOPTM</p>	<p><b>NATURAL GAS KIT</b> OPT-NGKNG - 0-290K BTU OPT-NGKNGHC - 291K+ BTU</p>	<p><b>LIQUID PROPANE KIT</b> OPT-LPKLP - 0-290K BTU OPT-LPKLPHC - 291K+ BTU</p>
---	--	--	--	--	--	---

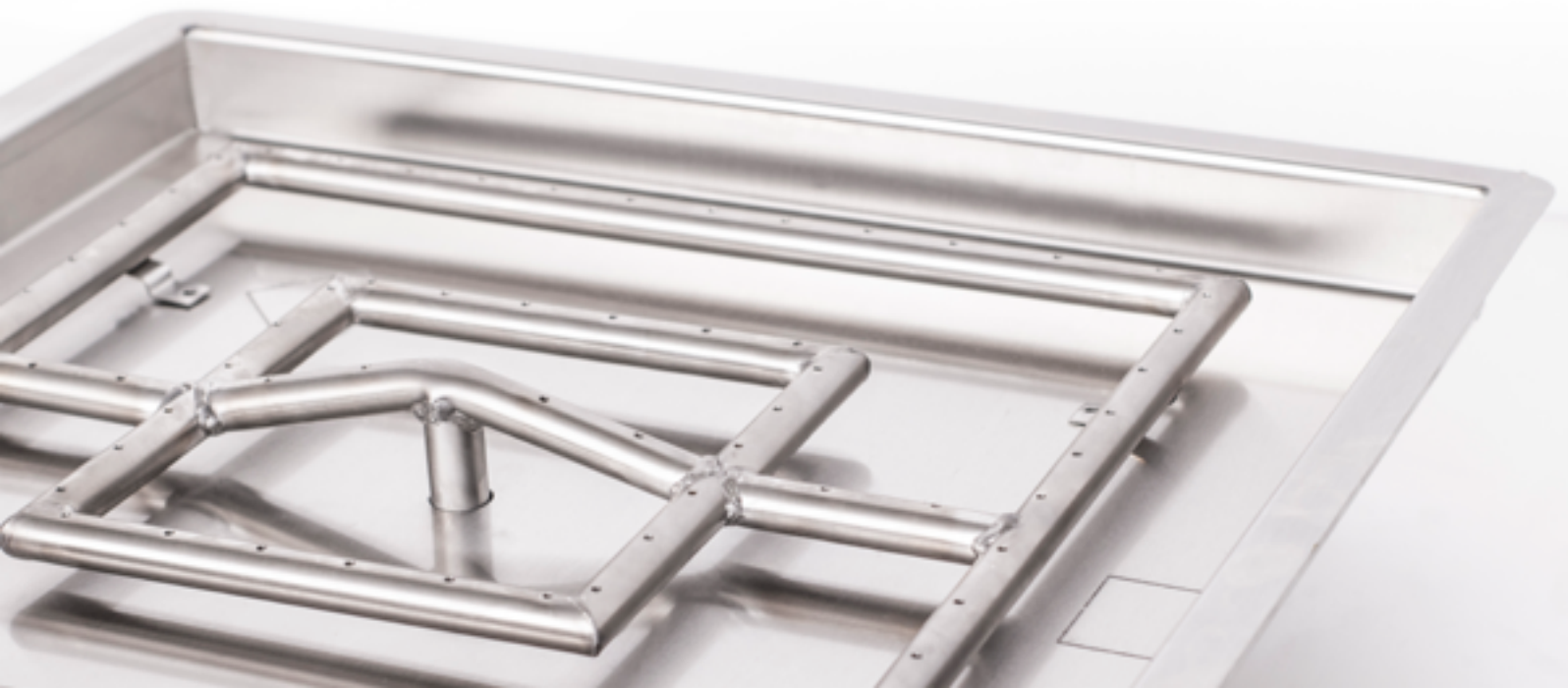

# RAISED LIP PAN & SS BURNER KITS

 LIFETIME WARRANTY ON ALL BURNERS

Suitable for either natural gas or liquid propane applications. Pans have 1" x 1" Lip & 3" Height. Electronic ignition systems require 10" clearance below the pan. 110V Ignition System Kits use a 3-prong grounded plug.

**BURNER SIZE GUIDE:** **M** = Double Inlet and uses manifold that adds 5" in height below the pan ; **2R** = 2 Rings ; **3R** = 3 Rings ; **4R** = 4 Rings



## Square Drop In Pan & Square SS Burner

ITEM	PAN & BURNER ONLY	FLAME SENSE MATCH LIT CERTIFIED	FLAME SENSE W/ SPARK IGNITION	ELECTRONIC 12V CSA CERTIFIED	ELECTRONIC 110V CSA CERTIFIED	BURNER SIZE	GAS INLET	BTU
16.5" Drop In Kit	OPT-RLSQR16	OPT-RLSQR16FSML	OPT-RLSQR16FSEN	OPT-RLSQR16E12	OPT-RLSQR16E110	12"	½"	90,000
18" Drop In Kit	OPT-RLSQR18	OPT-RLSQR18FSML	OPT-RLSQR18FSEN	OPT-RLSQR18E12	OPT-RLSQR18E110	12"	½"	90,000
24" Drop In Kit	OPT-RLSQR24	OPT-RLSQR24FSML	OPT-RLSQR24FSEN	OPT-RLSQR24E12	OPT-RLSQR24E110	18" (2R)	½"	160,000
30" Drop In Kit	OPT-RLSQR30	N/A	OPT-RLSQR30FSEN	OPT-RLSQR30E12	OPT-RLSQR30E110	24" (2R)	½"	190,000
36" Drop In Kit	OPT-RLSQR36	N/A	N/A	OPT-RLSQR36E12	OPT-RLSQR36E110	30" (3R)	¾"	310,000
48" Drop In Kit	OPT-RLSQR48	N/A	N/A	OPT-RLSQR48E12	OPT-RLSQR48E110	36" (3R)	¾"	375,000



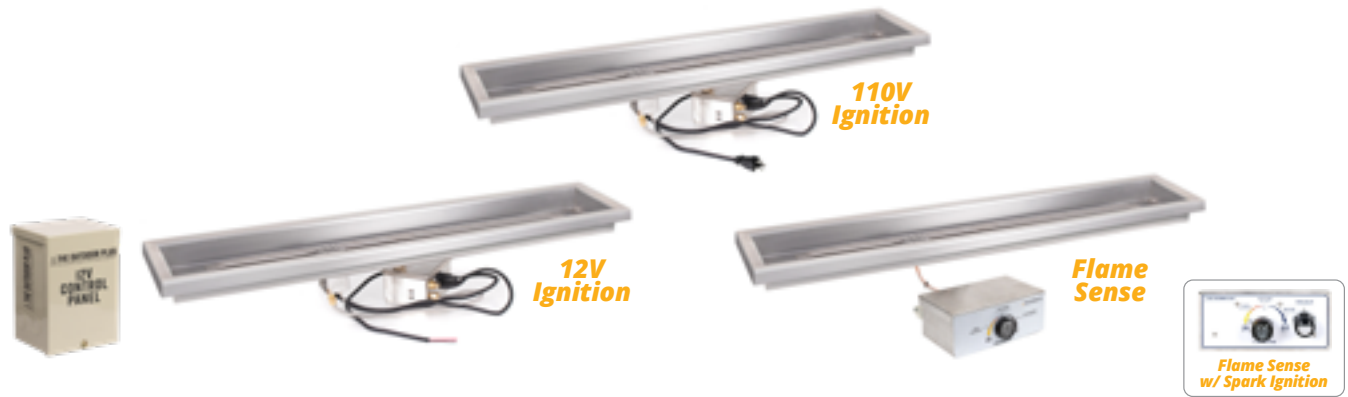

## Rectangular Drop In Pan & SS Linear Burner

ITEM	PAN & BURNER ONLY	FLAME SENSE MATCH LIT CERTIFIED	FLAME SENSE W/ SPARK IGNITION	ELECTRONIC 12V CSA CERTIFIED	ELECTRONIC 110V CSA CERTIFIED	BURNER SIZE	GAS INLET	BTU
24"x8" Rectangle	OPT-RLRCT248	OPT-RLRCT248FSML	OPT-RLRCT248FSEN	OPT-RLRCT248E12	OPT-RLRCT248E110	18"	½"	30,000
30"x8" Rectangle	OPT-RLRCT308	OPT-RLRCT308FSML	OPT-RLRCT308FSEN	OPT-RLRCT308E12	OPT-RLRCT308E110	24"	½"	40,000
36"x8" Rectangle	OPT-RLRCT368	OPT-RLRCT368FSML	OPT-RLRCT368FSEN	OPT-RLRCT368E12	OPT-RLRCT368E110	30"	½"	50,000
42"x8" Rectangle	OPT-RLRCT428	OPT-RLRCT428FSML	OPT-RLRCT428FSEN	OPT-RLRCT428E12	OPT-RLRCT428E110	36"	½"	60,000
48"x8" Rectangle	OPT-RLRCT488	OPT-RLRCT488FSML	OPT-RLRCT488FSEN	OPT-RLRCT488E12	OPT-RLRCT488E110	42"	½"	70,000
60"x8" Rectangle	OPT-RLRCT608	OPT-RLRCT608FSML	OPT-RLRCT608FSEN	OPT-RLRCT608E12	OPT-RLRCT608E110	48"	½"	80,000
72"x8" Rectangle	OPT-RLRCT728	OPT-RLRCT728FSML	OPT-RLRCT728FSEN	OPT-RLRCT728E12	OPT-RLRCT728E110	60"	½"	100,000
84"x8" Rectangle	OPT-RLRCT848	N/A	N/A	OPT-RLRCT848E12	OPT-RLRCT848E110	72"	¾"	120,000
96"x8" Rectangle	OPT-RLRCT968	N/A	N/A	OPT-RLRCT968E12	OPT-RLRCT968E110	84"	¾"	140,000



## Rectangular Drop In Pan & SS 'H' Burner

ITEM	PAN & BURNER ONLY	FLAME SENSE MATCH LIT CERTIFIED	FLAME SENSE W/ SPARK IGNITION	ELECTRONIC 12V CSA CERTIFIED	ELECTRONIC 110V CSA CERTIFIED	BURNER SIZE	GAS INLET	BTU
24"x12" Rectangle	OPT-RLRCT2412	OPT-RLRCT2412FSML	OPT-RLRCT2412FSEN	OPT-RLRCT2412E12	OPT-RLRCT2412E110	18" x 6"	½"	30,000
30"x12" Rectangle	OPT-RLRCT3012	OPT-RLRCT3012FSML	OPT-RLRCT3012FSEN	OPT-RLRCT3012E12	OPT-RLRCT3012E110	24" x 6"	½"	40,000
36"x12" Rectangle	OPT-RLRCT3612	OPT-RLRCT3612FSML	OPT-RLRCT3612FSEN	OPT-RLRCT3612E12	OPT-RLRCT3612E110	30" x 6"	½"	50,000
42"x12" Rectangle	OPT-RLRCT4212	OPT-RLRCT4212FSML	OPT-RLRCT4212FSEN	OPT-RLRCT4212E12	OPT-RLRCT4212E110	36" x 6"	½"	60,000
48"x12" Rectangle	OPT-RLRCT4812	N/A	N/A	OPT-RLRCT4812E12	OPT-RLRCT4812E110	42" x 6"	½"	70,000
60"x12" Rectangle	OPT-RLRCT6012	N/A	N/A	OPT-RLRCT6012E12	OPT-RLRCT6012E110	48" x 6"	½"	80,000
72"x12" Rectangle	OPT-RLRCT7212	N/A	N/A	OPT-RLRCT7212E12	OPT-RLRCT7212E110	60" x 6"	½"	100,000
84"x12" Rectangle	OPT-RLRCT8412	N/A	N/A	OPT-RLRCT8412E12	OPT-RLRCT8412E110	72" x 6" (M)	¾"	120,000
96"x12" Rectangle	OPT-RLRCT9612	N/A	N/A	OPT-RLRCT9612E12	OPT-RLRCT9612E110	84" x 6" (M)	¾"	140,000

Suitable for either natural gas or liquid propane applications. Pans have 2" Height. Electronic ignition systems require 10" clearance below the pan. 110V Ignition System Kits use a 3-prong grounded plug.

**BURNER SIZE GUIDE:** **M** = Double Inlet and uses manifold that adds 5" in height below the pan ; **2R** = 2 Rings ; **3R** = 3 Rings ; **4R** = 4 Rings



## Square Drop In Pan & Square SS Burner

ITEM	PAN & BURNER ONLY	FLAME SENSE MATCH LIT CERTIFIED	FLAME SENSE W/ SPARK IGNITION	ELECTRONIC 12V CSA CERTIFIED	ELECTRONIC 110V CSA CERTIFIED	BURNER SIZE	GAS INLET	BTU
16.5" Pan Kit	OPT-LTSQR16	OPT-LTSQR16FSML	OPT-LTSQR16FSEN	OPT-LTSQR16E12	OPT-LTSQR16E110	12"	½"	90,000
18" Pan Kit	OPT-LTSQR18	OPT-LTSQR18FSML	OPT-LTSQR18FSEN	OPT-LTSQR18E12	OPT-LTSQR18E110	12"	½"	90,000
24" Pan Kit	OPT-LTSQR24	OPT-LTSQR24FSML	OPT-LTSQR24FSEN	OPT-LTSQR24E12	OPT-LTSQR24E110	18" (2R)	½"	160,000
30" Pan Kit	OPT-LTSQR30	N/A	OPT-LTSQR30FSEN	OPT-LTSQR30E12	OPT-LTSQR30E110	24" (2R)	½"	190,000
36" Pan Kit	OPT-LTSQR36	N/A	N/A	OPT-LTSQR36E12	OPT-LTSQR36E110	30" (3R)	¾"	310,000
48" Pan Kit	OPT-LTSQR48	N/A	N/A	OPT-LTSQR48E12	OPT-LTSQR48E110	36" (3R)	¾"	375,000



## Round Drop In Pan & Round SS Burner

ITEM	PAN & BURNER ONLY	FLAME SENSE MATCH LIT CERTIFIED	FLAME SENSE W/ SPARK IGNITION	ELECTRONIC 12V CSA CERTIFIED	ELECTRONIC 110V CSA CERTIFIED	BURNER SIZE	GAS INLET	BTU
12" Pan Kit	OPT-LTROR12	OPT-LTROR12FSML	OPT-LTROR12FSEN	OPT-LTROR12E12	OPT-LTROR12E110	6"	½"	65,000
18" Pan Kit	OPT-LTROR18	OPT-LTROR18FSML	OPT-LTROR18FSEN	OPT-LTROR18E12	OPT-LTROR18E110	12"	½"	90,000
24" Pan Kit	OPT-LTROR24	OPT-LTROR24FSML	OPT-LTROR24FSEN	OPT-LTROR24E12	OPT-LTROR24E110	18" (2R)	½"	160,000
30" Pan Kit	OPT-LTROR30	N/A	OPT-LTROR30FSEN	OPT-LTROR30E12	OPT-LTROR30E110	24" (2R)	½"	190,000
36" Pan Kit	OPT-LTROR36	N/A	N/A	OPT-LTROR36E12	OPT-LTROR36E110	30" (3R)	¾"	310,000
48" Pan Kit	OPT-LTROR48	N/A	N/A	OPT-LTROR48E12	OPT-LTROR48E110	36" (3R)	¾"	375,000





## Rectangular Drop In Pan & SS Linear Burner

ITEM	PAN & BURNER ONLY	FLAME SENSE MATCH LIT CERTIFIED	FLAME SENSE W/ SPARK IGNITION	ELECTRONIC 12V CSA CERTIFIED	ELECTRONIC 110V CSA CERTIFIED	BURNER SIZE	GAS INLET	BTU
24"x6" Pan Kit	OPT-LTRCT246	OPT-LTRCT246FSML	OPT-LTRCT246FSEN	OPT-LTRCT246E12	OPT-LTRCT246E110	18"	½"	30,000
30"x6" Pan Kit	OPT-LTRCT306	OPT-LTRCT306FSML	OPT-LTRCT306FSEN	OPT-LTRCT306E12	OPT-LTRCT306E110	24"	½"	40,000
36"x6" Pan Kit	OPT-LTRCT366	OPT-LTRCT366FSML	OPT-LTRCT366FSEN	OPT-LTRCT366E12	OPT-LTRCT366E110	30"	½"	50,000
42"x6" Pan Kit	OPT-LTRCT426	OPT-LTRCT426FSML	OPT-LTRCT426FSEN	OPT-LTRCT426E12	OPT-LTRCT426E110	36"	½"	60,000
48"x6" Pan Kit	OPT-LTRCT486	OPT-LTRCT486FSML	OPT-LTRCT486FSEN	OPT-LTRCT486E12	OPT-LTRCT486E110	42"	½"	70,000
60"x6" Pan Kit	OPT-LTRCT606	OPT-LTRCT606FSML	OPT-LTRCT606FSEN	OPT-LTRCT606E12	OPT-LTRCT606E110	48"	½"	80,000
72"x6" Pan Kit	OPT-LTRCT726	OPT-LTRCT726FSML	OPT-LTRCT726FSEN	OPT-LTRCT726E12	OPT-LTRCT726E110	60"	½"	100,000
84"x6" Pan Kit	OPT-LTRCT846	N/A	N/A	OPT-LTRCT846E12	OPT-LTRCT846E110	72"	¾"	120,000
96"x6" Pan Kit	OPT-LTRCT966	N/A	N/A	OPT-LTRCT966E12	OPT-LTRCT966E110	84"	¾"	140,000

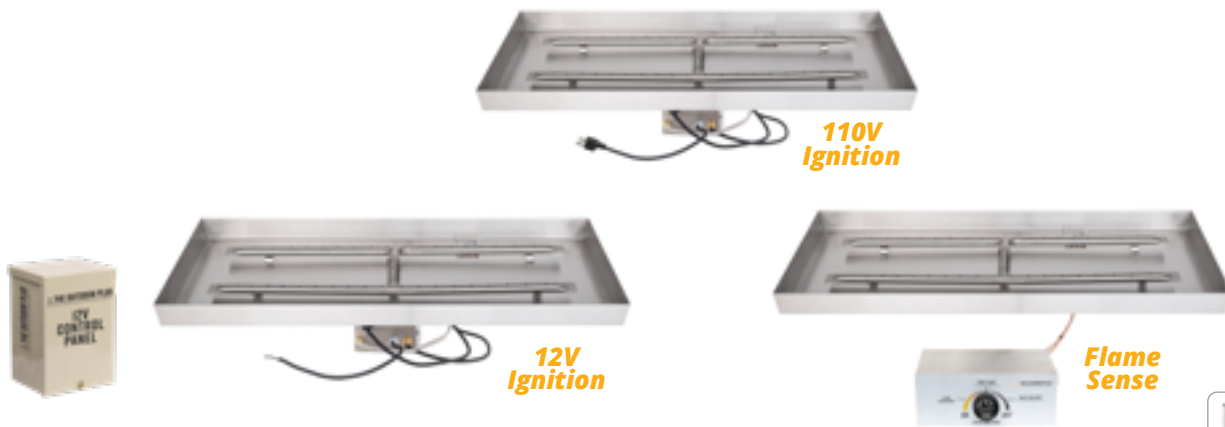

## Rectangular Drop In Pan & SS 'H' Burner

ITEM	PAN & BURNER ONLY	FLAME SENSE MATCH LIT CERTIFIED	FLAME SENSE W/ SPARK IGNITION	ELECTRONIC 12V CSA CERTIFIED	ELECTRONIC 110V CSA CERTIFIED	BURNER SIZE	GAS INLET	BTU
24"x12" Pan Kit	OPT-LTRCT2412	OPT-LTRCT2412FSML	OPT-LTRCT2412FSEN	OPT-LTRCT2412E12	OPT-LTRCT2412E110	18" x 6"	½"	30,000
30"x12" Pan Kit	OPT-LTRCT3012	OPT-LTRCT3012FSML	OPT-LTRCT3012FSEN	OPT-LTRCT3012E12	OPT-LTRCT3012E110	24" x 6"	½"	40,000
36"x12" Pan Kit	OPT-LTRCT3612	OPT-LTRCT3612FSML	OPT-LTRCT3612FSEN	OPT-LTRCT3612E12	OPT-LTRCT3612E110	30" x 6"	½"	50,000
42"x12" Pan Kit	OPT-LTRCT4212	OPT-LTRCT4212FSML	OPT-LTRCT4212FSEN	OPT-LTRCT4212E12	OPT-LTRCT4212E110	36" x 6"	½"	60,000
48"x12" Pan Kit	OPT-LTRCT4812	N/A	N/A	OPT-LTRCT4812E12	OPT-LTRCT4812E110	42" x 6"	½"	70,000
60"x12" Pan Kit	OPT-LTRCT6012	N/A	N/A	OPT-LTRCT6012E12	OPT-LTRCT6012E110	48" x 6"	½"	80,000
72"x12" Pan Kit	OPT-LTRCT7212	N/A	N/A	OPT-LTRCT7212E12	OPT-LTRCT7212E110	60" x 6"	½"	100,000
84"x12" Pan Kit	OPT-LTRCT8412	N/A	N/A	OPT-LTRCT8412E12	OPT-LTRCT8412E110	72" x 6" (M)	¾"	120,000
96"x12" Pan Kit	OPT-LTRCT9612	N/A	N/A	OPT-LTRCT9612E12	OPT-LTRCT9612E110	84" x 6" (M)	¾"	140,000

The Outdoor Plus' *Water-Over-Fire Pit Insert* is your solution to creating a unique fire feature. Its simple form allows it to drop into place like any other drop in pan, and its plug & play features allows for easy installation and operation.

The *Water-Over-Fire Kit* features all components necessary for plug & play operation: Burner, Water Ring, Water Lines, Water Drain, Water Pump (110V), Filter & Debris Catcher. 1/2" MIP Gas Inlet. All water over fire kits are NG or LP compatible.



PART #	DIAMETER	MINIMUM CUT-OUT	HEIGHT	SUGG. GLASS	BTU
OPT-300-WOFKIT-25	25"	25.5"	18"	35 lbs.	110,000
OPT-300-WOFKIT-31	31"	31.5"	18"	45 lbs.	130,000
OPT-300-WOFKIT-37	37"	37.5"	18"	55 lbs.	160,000

The water reservoirs requires an 18" clearance below.

## UNIT OVERVIEW

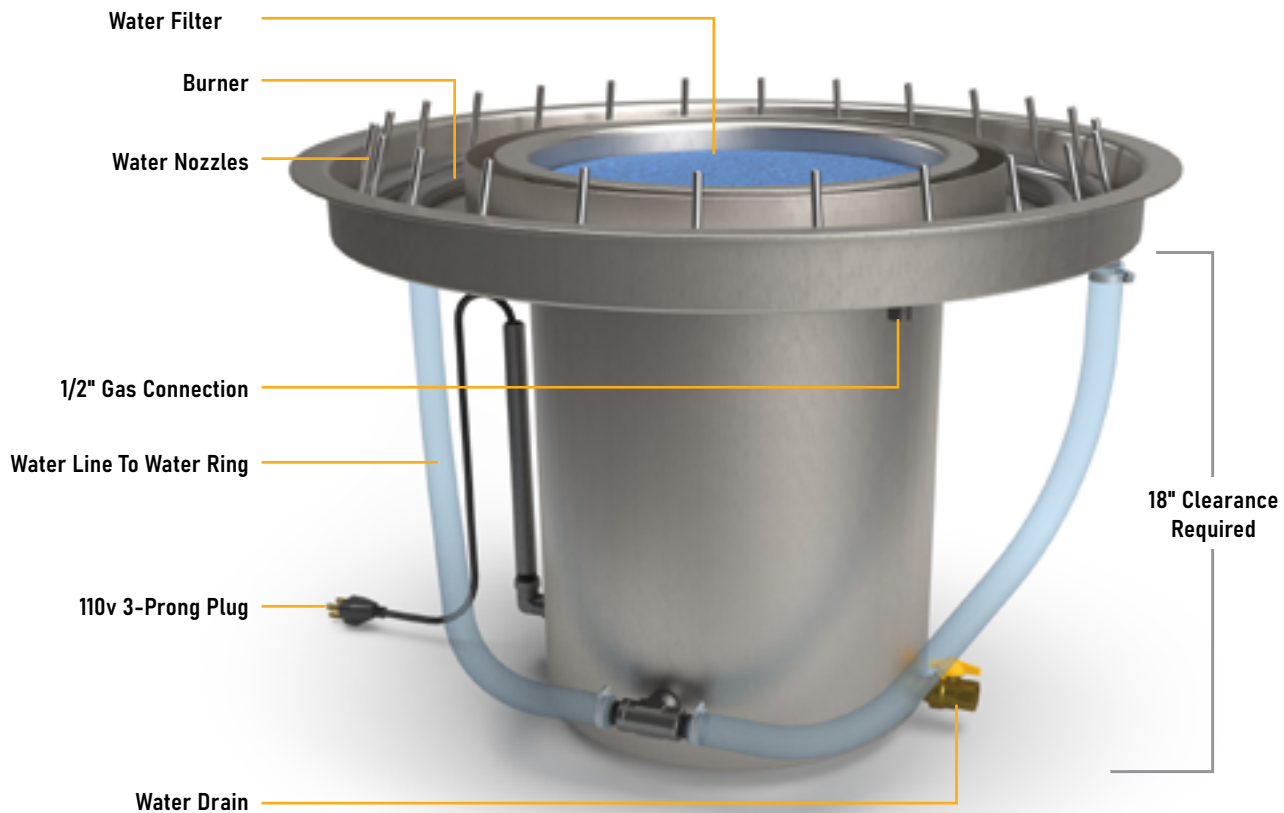



Our Patented Bullet Burner is the perfect way to get more out of any pre-existing fire pit. Its 1/2" gas inlet makes it easy to swap out with any pre-existing burner.

You can expect to get the same flame height while using less gas than your standard burner, or crank it up for a dramatic and impressive flame, taller than any standard burner is able to produce.



### Uniform Gas Flow Generator

Our Patented Hub Distributes Gas Evenly Throughout The Burner



### BULLET ORIFICE FLAME SPREADER

### Precision Machined Components

Gives You Consistent Quality & Durability That You Can Rely On

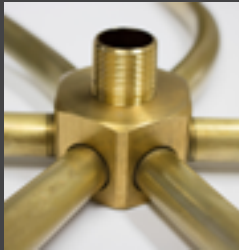

### Flat Flame Technology

Our Patented Bullet Orifice Compresses Gas Flow & Incorporates Oxygen To Create A Cleaner Flame

### Individually Assembled

Quality Control To Provide You With A Great Product Every Single Time



IMPORT BURNER



PATENTED BULLET BURNER

The Patented Bullet Burner's eliminate the need for an additional LP air mixer. Suitable for either natural gas or liquid propane applications. Pans have 1" Lip & 2" Height. Electronic ignition require 10" clearance below the pan. 110V Ignition System Kits use a 3-prong grounded plug.

**BURNER SIZE GUIDE:** **M** = Double Inlet and uses manifold that adds 5" in height below the pan ; **2R** = 2 Rings ; **3R** = 3 Rings ; **4R** = 4 Rings



### Triple 'S' Burner - Brass & Stainless Steel

PART # (BRASS)	PART # (STAINLESS)	DIAMETER	BTU	INLET
OPT-B8B	OPT-B8SS	8"	40,000	1/2"
OPT-B12B	OPT-B12SS	12"	60,000	1/2"
OPT-B18B	OPT-B18SS	18"	90,000	1/2"
OPT-B24B	OPT-B24SS	24"	120,000	1/2"
OPT-B30B	OPT-B30SS	30"	150,000	1/2"
OPT-B36B	OPT-B36SS	36"	240,000	3/4"
OPT-B48B	OPT-B48SS	48"	320,000	3/4"



### Linear Brass Bullet Burner

PART # (BRASS)	PART # (STAINLESS)	LENGTH	BTU	INLET
OPT-B18BT	OPT-B18SST	18"	30,000	1/2"
OPT-B24BT	OPT-B24SST	24"	40,000	1/2"
OPT-B30BT	OPT-B30SST	30"	50,000	1/2"
OPT-B36BT	OPT-B36SST	36"	60,000	1/2"
OPT-B48BT	OPT-B48SST	48"	80,000	1/2"
OPT-B60BT	OPT-B60SST	60"	100,000	1/2"
OPT-B72BT	OPT-B72SST	72"	120,000	1/2"
OPT-B84BT	OPT-B84SST	84"	140,000	3/4"
OPT-B96BT	OPT-B96SST	96" (M)	160,000	3/4"



### 'H' Brass Bullet Burner

PART # (BRASS)	PART # (STAINLESS)	LENGTH	WIDTH	BTU	INLET
OPT-B18BH	OPT-B18SSH	18"	6"	70,000	1/2"
OPT-B24BH	OPT-B24SSH	24"	6"	90,000	1/2"
OPT-B30BH	OPT-B30SSH	30"	6"	110,000	1/2"
OPT-B36BH	OPT-B36SSH	36"	6"	130,000	1/2"
OPT-B48BH	OPT-B48SSH	48"	6"	170,000	1/2"
OPT-B60BH	OPT-B60SSH	60" (M)	6"	210,000	3/4"
OPT-B72BH	OPT-B72SSH	72" (M)	6"	250,000	3/4"

**BURNER SIZE GUIDE:** **M** = Double Inlet and uses manifold that adds 5" in height below the pan ; **2R** = 2 Rings ; **3R** = 3 Rings ; **4R** = 4 Rings



**Square Stainless Bullet Burner**

PART #	SIZE	BTU	INLET
OPT-BSQSS8	8"	55,000	½"
OPT-BSQSS12	12"	80,000	½"
OPT-BSQSS18	18" (2R)	20,000	½"
OPT-BSQSS24	24" (2R)	240,000	½"
OPT-BSQSS30	30" (3R)	420,000	½"
OPT-BSQSS36	36" (3R)	480,000	¾"
OPT-BSQSS48	48" (4R, M)	80,000	¾"



**Round Stainless Bullet Burner**

PART #	SIZE	BTU	INLET
OPT-BRDSS8	8"	45,000	½"
OPT-BRDSS12	12"	65,000	½"
OPT-BRDSS18	18" (2R)	160,000	½"
OPT-BRDSS24	24" (2R)	190,000	½"
OPT-BRDSS30	30" (3R)	330,000	½"
OPT-BRDSS36	36" (3R)	380,000	¾"
OPT-BRDSS48	48" (4R, M)	630,000	¾"



**Switchback Stainless Bullet Burner**

PART #	SIZE	BTU	INLET
OPT-BSWSS18	18" x 6"	60,000	½"
OPT-BSWSS24	24" x 6"	75,000	½"
OPT-BSWSS30	30" x 6"	90,000	½"
OPT-BSWSS36	36" x 6"	105,000	½"
OPT-BSWSS48	48" x 6"	140,000	½"
OPT-BSWSS60	60" x 6" (M)	170,000	¾"
OPT-BSWSS72	72" x 6" (M)	200,000	¾"



**Racetrack Stainless Bullet Burner**

PART #	SIZE	BTU	INLET
OPT-BRTSS186	18" x 6"	70,000	½"
OPT-BRTSS246	24" x 6"	90,000	½"
OPT-BRTSS306	30" x 6"	110,000	½"
OPT-BRTSS366	36" x 6"	130,000	½"
OPT-BRTSS486	48" x 6"	170,000	½"
OPT-BRTSS606	60" x 6" (M)	210,000	¾"
OPT-BRTSS726	72" x 6" (M)	250,000	¾"



**Rectangle Stainless Bullet Burner**

PART #	SIZE	BTU	INLET
OPT-BRTSS1812	18" x 12"	130,000	½"
OPT-BRTSS2412	24" x 12"	160,000	½"
OPT-BRTSS3012	30" x 12"	190,000	½"
OPT-BRTSS3612	36" x 12"	220,000	¾"
OPT-BRTSS4812	48" x 12" (M)	280,000	¾"
OPT-BRTSS6012	60" x 12" (M)	340,000	¾"
OPT-BRTSS7212	72" x 12" (M)	400,000	¾"



**Double Rectangle Stainless Bullet Burner**

PART #	SIZE	BTU	INLET
OPT-BDRTSS1812	18" x 12"	190,000	½"
OPT-BDRTSS2412	24" x 12"	240,000	½"
OPT-BDRTSS3012	30" x 12"	290,000	½"
OPT-BDRTSS3612	36" x 12"	340,000	¾"
OPT-BDRTSS4812	48" x 12"	440,000	¾"
OPT-BDRTSS6012	60" x 12" (M)	540,000	¾"
OPT-BDRTSS7212	72" x 12" (M)	640,000	¾"



**STANDARD 18" STAINLESS  
STEEL H-BURNER**

**BRASS BULLET BURNER  
18" H-BURNER**

Our fire burners are individually crafted from 304 stainless steel. T.O.P's burner holes are individually drilled, not punched, creating a better flame. Gas Inlets are slightly raised to prevent water from entering your gas line. NG or LP compatible. Made in the USA.

**BURNER SIZE GUIDE:** **M** = Double Inlet and uses manifold that adds 5" in height below the pan ; **2R** = 2 Rings ; **3R** = 3 Rings ; **4R** = 4 Rings



## Round Burner

PART #	SIZE	INLET	BTUS
OPT-158-5	5"	1/2"	30,000
OPT-158	6"	1/2"	35,000
OPT-158-8	8"	1/2"	45,000
OPT-159	12"	1/2"	65,000
OPT-160	18" (2R)	1/2"	160,000
OPT-161	24" (2R)	1/2"	190,000
OPT-161-30	30" (3R)	3/4"	330,000
OPT-162	36" (3R)	3/4"	380,000
OPT-162-48	48" (4R) (M)	3/4"	630,000



## Triple "S" Star Burner

PART #	SIZE	INLET	BTUS
OPT-3S12	12"	1/2"	60,000
OPT-3S18	18"	1/2"	90,000
OPT-3S24	24"	1/2"	120,000
OPT-3S30	30"	3/4"	150,000
OPT-3S36	36"	3/4"	180,000
OPT-3S42	42"	3/4"	210,000
OPT-3S48	48"	3/4"	240,000



## "H" Burner

PART #	SIZE	INLET	BTUS
OPT-181	6" x 18"	1/2"	70,000
OPT-182	6" x 24"	1/2"	90,000
OPT-183	6" x 30"	1/2"	110,000
OPT-184	6" x 36"	1/2"	130,000
OPT-18448	6" x 48"	3/4"	170,000
OPT-18466	6" x 60" (M)	3/4"	210,000
OPT-18472	6" x 72" (M)	3/4"	250,000
OPT-18484	6" x 84" (M)	3/4"	290,000
OPT-18496	6" x 96" (M)	3/4"	410,000



## "T" Burner

PART #	SIZE	INLET	BTUS
OPT-16616	16"	1/2"	30,000
OPT-167	24"	1/2"	40,000
OPT-168	30"	1/2"	50,000
OPT-169	36"	1/2"	60,000
OPT-166T48	48"	1/2"	80,000
OPT-166T60	60"	1/2"	100,000
OPT-166T72	72"	3/4"	120,000
OPT-166T84	84"	3/4"	140,000
OPT-166T96	96" (M)	3/4"	160,000
OPT-166T108	108" (M)	3/4"	180,000
OPT-166T120	120" (M)	3/4"	200,000



## S-Burner

PART #	SIZE	INLET	BTUS
OPT-3013	6" x 18"	1/2"	50,000
OPT-3014	6" x 24"	1/2"	50,000
OPT-301530	6" x 30"	1/2"	75,000
OPT-3015	6" x 36"	1/2"	90,000
OPT-3016	6" x 48"	1/2"	100,000
OPT-301660	6" x 60"	3/4"	120,000
OPT-3017	6" x 72"	3/4"	150,000
OPT-301784	6" x 84"	3/4"	150,000
OPT-301796	6" x 96" (M)	3/4"	200,000
OPT-3017108	6" x 108" (M)	3/4"	200,000
OPT-3017120	6" x 120" (M)	3/4"	200,000



## Half Moon Burner

PART #	SIZE	INLET	BTUS
OPT-HM18	18" x 9" (2R)	1/2"	80,000
OPT-HM24	24" x 12" (2R)	1/2"	90,000
OPT-HM30	30" x 15" (3R)	1/2"	120,000
OPT-HM36	36" x 18" (3R)	3/4"	140,000
OPT-HM42	42" x 21" (4R)	3/4"	150,000
OPT-HM48	48" x 24" (4R)	3/4"	175,000





## Square Burner

PART #	SIZE	INLET	BTUS
OPT-30076	6" x 6"	1/2"	40,000
OPT-3007	12" x 12" (2R)	1/2"	80,000
OPT-3008	18" x 18" (2R)	1/2"	200,000
OPT-3009	24" x 24" (2R)	1/2"	240,000
OPT-300930	30" x 30" (3R)	3/4"	420,000
OPT-300936	36" x 36" (3R)	3/4"	480,000
OPT-300942	42" x 42" (3R)	3/4"	540,000
OPT-300948	48" x 48" (4R) (M)	3/4"	800,000
OPT-300960	60" x 60" (4R) (M)	3/4"	1.1M



## Triangle Burner

PART #	SIZE	INLET	BTUS
OPT-3001	12"	1/2"	60,000
OPT-3002	18" (2R)	1/2"	150,000
OPT-3003	24" (2R)	1/2"	180,000
OPT-300330	30" (3R)	3/4"	315,000
OPT-3004	36" (3R)	3/4"	360,000
OPT-300448	48" (4R)	3/4"	600,000



## Rectangle Burner

PART #	SIZE	INLET	BTUS
OPT-3010	6" x 12"	1/2"	60,000
OPT-3011	6" x 18"	1/2"	80,000
OPT-301124	6" x 24"	1/2"	100,000
OPT-301130	6" x 30"	1/2"	120,000
OPT-301136	6" x 36"	1/2"	140,000
OPT-301148	6" x 48"	3/4"	180,000
OPT-3012	12" x 24"	1/2"	120,000
OPT-301230	12" x 30"	1/2"	140,000
OPT-301236	12" x 36"	1/2"	160,000
OPT-301242	12" x 42"	1/2"	180,000
OPT-301248	12" x 48"	3/4"	200,000
OPT-301260	12" x 60" (M)	3/4"	240,000
OPT-301272	12" x 72" (M)	3/4"	280,000

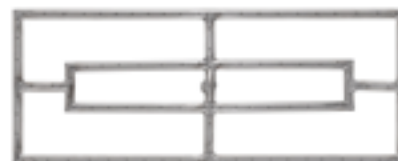

## Double Rectangle Burner

PART #	SIZE	INLET	BTUS
OPT-DR1224	12" x 24"	1/2"	200,000
OPT-DR1230	12" x 30"	1/2"	240,000
OPT-DR1236	12" x 36"	1/2"	280,000
OPT-DR1242	12" x 42"	1/2"	320,000
OPT-DR1248	12" x 48"	3/4"	360,000
OPT-DR1260	12" x 60"	3/4"	440,000
OPT-DR1272	12" x 72"	3/4"	520,000
OPT-DR1830	18" x 30"	1/2"	280,000
OPT-DR1836	18" x 36"	1/2"	320,000
OPT-DR1842	18" x 42"	1/2"	360,000
OPT-DR1848	18" x 48"	3/4"	400,000
OPT-DR1860	18" x 60" (M)	3/4"	480,000



## Lotus Burner

PART #	SIZE	INLET	BTUS
OPT-18LTS	18"	1/2"	125,000
OPT-24LTS	24"	1/2"	150,000
OPT-30LTS	30"	1/2"	200,000
OPT-36LTS	36"	3/4"	220,000
OPT-42LTS	42"	3/4"	260,000
OPT-48LTS	48"	3/4"	300,000



## Star Burner

PART #	SIZE	INLET	BTU
OPT-171	12"	1/2"	90,000
OPT-171A	16"	1/2"	90,000
OPT-17118	18"	1/2"	90,000
OPT-172	24"	1/2"	150,000
OPT-17230	30"	3/4"	200,000
OPT-17236	36"	3/4"	300,000
OPT-17248	48"	3/4"	300,000

Our fire burners are individually crafted from 304 stainless steel. T.O.P's burner holes are individually drilled, not punched, creating a better flame. Gas Inlets are slightly raised to prevent water from entering your gas line. NG or LP compatible. Made in the USA.

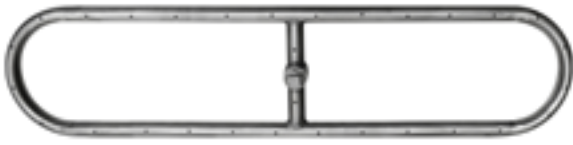

### Racetrack Steel Burner

PART #	SIZE	INLET	BTUS
OPT-RT618	6" x 18"	1/2"	50,000
OPT-RT624	6" x 24"	1/2"	60,000
OPT-RT630	6" x 30"	1/2"	70,000
OPT-RT636	6" x 36"	1/2"	90,000
OPT-RT648	6" x 48"	1/2"	100,000
OPT-RT1224	12" x 24"	1/2"	80,000
OPT-RT1230	12" x 30"	1/2"	90,000
OPT-RT1236	12" x 36"	1/2"	90,000
OPT-RT1242	12" x 42"	1/2"	100,000
OPT-RT1248	12" x 48"	1/2"	180,000
OPT-RT1254	12" x 54"	3/4"	190,000
OPT-RT1260	12" x 60" (M)	3/4"	200,000
OPT-RT1272	12" x 72" (M)	3/4"	240,000



### Double Racetrack Burner

PART #	SIZE	INLET	BTUS
OPT-DRT1224	12" x 24"	1/2"	90,000
OPT-DRT1230	12" x 30"	1/2"	90,000
OPT-DRT1236	12" x 36"	1/2"	100,000
OPT-DRT1242	12" x 42"	1/2"	120,000
OPT-DRT1248	12" x 48"	3/4"	140,000
OPT-DRT1254	12" x 54"	3/4"	200,000
OPT-DRT1260	12" x 60" (M)	3/4"	220,000
OPT-DRT1272	12" x 72" (M)	3/4"	220,000
OPT-DRT1830	18" x 30"	3/4"	100,000
OPT-DRT1836	18" x 36"	3/4"	120,000
OPT-DRT1842	18" x 42"	3/4"	120,000
OPT-DRT1848	18" x 48"	3/4"	180,000
OPT-DRT1860	18" x 60" (M)	3/4"	190,000
OPT-DRT1872	18" x 72" (M)	3/4"	200,000
OPT-DRT1884	18" x 84" (M)	3/4"	200,000



### Switch Back Burner

PART #	SIZE	INLET	BTUS
OPT-SB18	7" x 18"	1/2"	65,000
OPT-SB24	7" x 24"	1/2"	75,000
OPT-SB30	7" x 30"	1/2"	90,000
OPT-SB36	7" x 36"	1/2"	100,000
OPT-SB48	7" x 48"	1/2"	120,000
OPT-SB60	7" x 60" (M)	3/4"	160,000
OPT-SB72	7" x 72" (M)	3/4"	200,000
OPT-SB84	7" x 84" (M)	3/4"	240,000
OPT-SB96	7" x 96" (M)	3/4"	280,000
OPT-SB108	7" x 108" (M)	3/4"	320,000
OPT-SB120	7" x 120" (M)	3/4"	400,000
OPT-SB2412	12" x 24" (M)	1/2"	65,000
OPT-SB3012	12" x 30"	1/2"	75,000
OPT-SB3612	12" x 36"	1/2"	90,000
OPT-SB4812	12" x 48"	1/2"	100,000
OPT-SB6012	12" x 60" (M)	3/4"	120,000
OPT-SB7212	12" x 72" (M)	3/4"	160,000
OPT-SB8412	12" x 84" (M)	3/4"	200,000
OPT-SB9612	12" x 96" (M)	3/4"	240,000
OPT-SB10812	12" x 108" (M)	3/4"	280,000
OPT-SB12012	12" x 120" (M)	3/4"	400,000



### Fish Eye Burner

PART #	SIZE	INLET	BTUS
OPT-FE18	6" x 18"	1/2"	70,000
OPT-FE24	6" x 24"	1/2"	70,000
OPT-FE30	6" x 30"	1/2"	90,000
OPT-FE36	6" x 36"	1/2"	150,000
OPT-FE48	6" x 48"	1/2"	150,000



### Double Fish Eye Burner

PART #	SIZE	INLET	BTUS
OPT-FE24D	12" x 24"	1/2"	100,000
OPT-FE36D	12" x 36"	1/2"	140,000
OPT-FE48D	12" x 48"	3/4"	180,000
OPT-FE60D	12" x 60"	3/4"	200,000

**BURNER SIZE GUIDE:** **M** = Double Inlet and uses manifold that adds 5" in height below the pan ; **2R** = 2 Rings ; **3R** = 3 Rings ; **4R** = 4 Rings



**Wheel Burner**

PART #	SIZE	INLET	BTUS
OPT-W18	18"	1/2"	125,000
OPT-W24	24"	1/2"	150,000
OPT-W30	30"	1/2"	200,000
OPT-W36	36"	3/4"	220,000
OPT-W42	42"	3/4"	260,000
OPT-W48	48"	3/4"	300,000



**Single Ring Burner**

PART #	SIZE	INLET	BTUS
OPT-12SR	12"	1/2"	60,000
OPT-18SR	18"	1/2"	70,000
OPT-24SR	24"	1/2"	80,000
OPT-30SR	30"	1/2"	90,000
OPT-36SR	36"	3/4"	90,000
OPT-42SR	42"	3/4"	100,000
OPT-48SR	48"	3/4"	100,000



## Custom Burners

### Any Size, Any Shape

Do you need a specific size? Do you have an logo or design that you would like created in burner form? We can do that for you!

We manufacture all of T.O.P's products in house and that allows us to build practically anything. Design it yourself or send in pencil sketches and T.O.P's in house specialist can design it for you. Email or call us today to learn more!



# FIREPLACE BURNERS



## Fireplace Log Lighter Burner

PART #	SIZE	INLET	BTUS
OPT-173-12	12"	1/2"	20,000
OPT-173	18"	1/2"	30,000
OPT-174	24"	1/2"	40,000
OPT-175	30"	1/2"	50,000
OPT-17536	36"	1/2"	60,000
OPT-17542	42"	1/2"	70,000
OPT-17548	48"	1/2"	80,000
OPT-17560	60"	3/4"	100,000

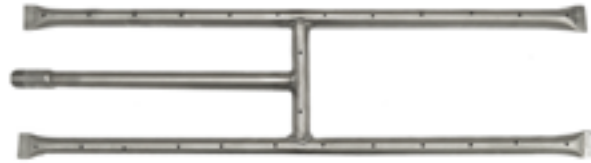

## Fireplace H-Burner

PART #	SIZE	INLET	BTUS
OPT-154	6" x 18"	1/2"	70,000
OPT-155	6" x 24"	1/2"	90,000
OPT-156	6" x 30"	1/2"	110,000
OPT-157	6" x 36"	1/2"	130,000
OPT-15748	12" x 48"	3/4"	170,000
OPT-15760	12" x 60"	3/4"	210,000
OPT-15772	12" x 72"	3/4"	250,000



## Stainless Steel Whistle Free Hose

Includes: Hose, Flare to Non-Flared Fittings. Max 1/2 PSI

LENGTH	3/8" HOSE (1/2" FITTINGS)	1/2" HOSE (1/2" FITTINGS)	3/4" HOSE (3/4" FITTINGS)
12"	OPT-245	OPT-238	N/A
18"	OPT-246	OPT-239	N/A
24"	OPT-247	OPT-240	N/A
36"	OPT-248	OPT-241	OPT-248HC
48"	OPT-249	OPT-242	N/A



## Gas Key Valves

Includes Key Valve, Valve Cover & Key

ITEM	CHROME	GOLD	ANTIQUE	BLACK
1/2" Standard Key Valve	OPT-256	OPT-256GO	OPT-256AN	OPT-256BL
1/2" Ball Valve	OPT-256FF	OPT-256FFGO	OPT-256FFAN	OPT-256FFBL
3/4" Ball Valve	OPT-25634	OPT-25634GGO	OPT-25634 AN	OPT-25634BL
1/2" Ball Valve 90° Bend	OPT-259FF	OPT-259FFGO	OPT-259FFAN	OPT-259FFBL
3/4" Ball Valve 90° Bend	OPT-35690	OPT-35690GO	OPT-35690AN	OPT-35690BL

Looking to add some flare to your fireplace? See T.O.P's ornaments & sculpture collection on the next page

Custom Stainless Steel Sculpture



Custom 48" Stainless Steel Tangled Fireplace Burner