

RECTANGULAR DROP IN PAN & H BULLET BURNER MATCH LIT IGNITION

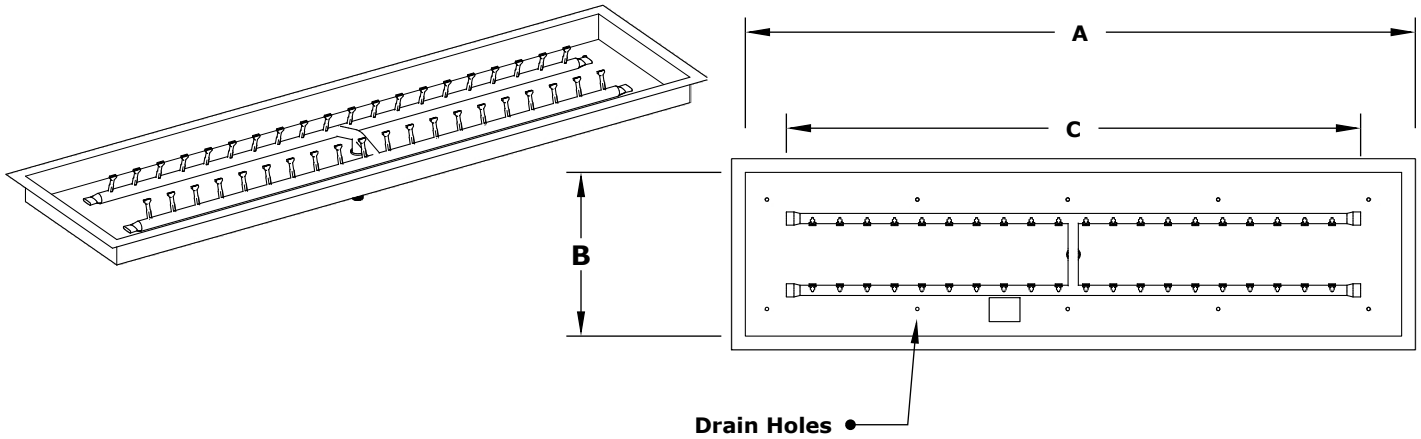

ISOMETRIC VIEW

TOP VIEW

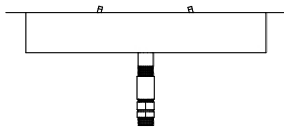

RIGHT SIDE VIEW

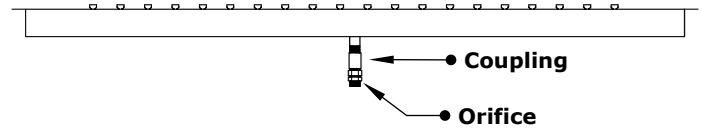

FRONT SIDE VIEW

Brass	Stainless Steel	A	B	C	D	INLET	BTU
OPT-BP1224RD	OPT-BP1224RDSS	24"	8"	18"	6"	1/2"	85,000
OPT-BP1236RD	OPT-BP1236RDSS	36"	8"	24"	6"	1/2"	110,000
OPT-BP1248RD	OPT-BP1248RDSS	48"	8"	36"	6"	1/2"	160,000
OPT-BP1260RD	OPT-BP1260RDSS	60"	8"	48"	6"	1/2"	205,000
OPT-BP1272RD	OPT-BP1272RDSS	72"	8"	60" (M)	6"	3/4"	255,000
OPT-BP1284RD	OPT-BP1284RDSS	84"	8"	72" (M)	6"	3/4"	300,000
OPT-BP1296RD	OPT-BP1296RDSS	96"	8"	84" (M)	6"	3/4"	350,000

Pan Material: Aluminum
Burner Material: Brass / Stainless Steel
Ignition Type: Match Lit

Includes: Pan, Burner, Electronic Valve.

M = Manifold

RECTANGULAR DROP IN PAN & H BULLET BURNER 12V ELECTRONIC IGNITION

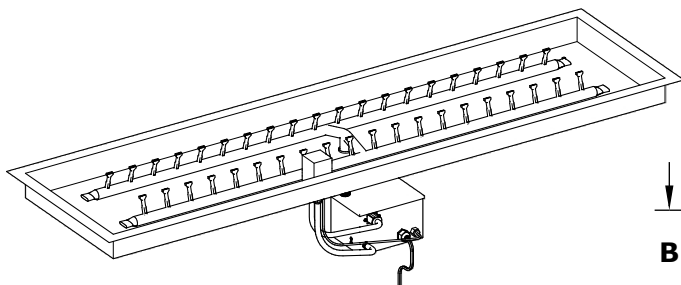

ISOMETRIC VIEW

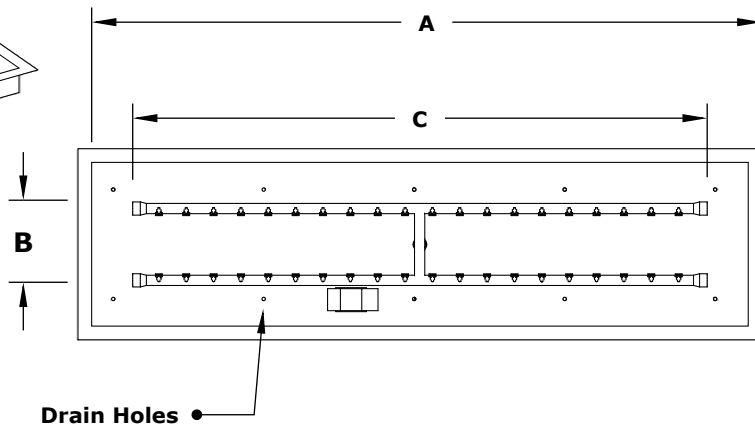

TOP VIEW

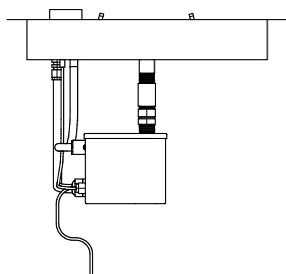

RIGHT SIDE VIEW

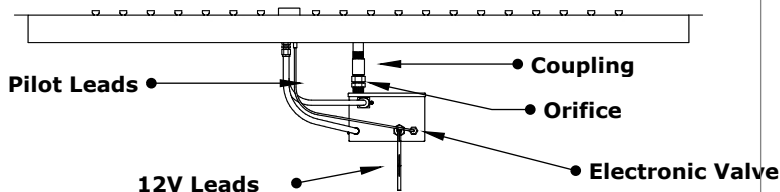

FRONT SIDE VIEW

Brass	Stainless Steel	A	B	C	D	INLET	BTU
OPT-BP1224RDE12	OPT-BP1224RDSSE12	24"	8"	18"	6"	1/2"	85,000
OPT-BP1236RDE12	OPT-BP1236RDSSE12	36"	8"	24"	6"	1/2"	110,000
OPT-BP1248RDE12	OPT-BP1248RDSSE12	48"	8"	36"	6"	1/2"	160,000
OPT-BP1260RDE12	OPT-BP1260RDSSE12	60"	8"	48"	6"	1/2"	205,000
OPT-BP1272RDE12	OPT-BP1272RDSSE12	72"	8"	60" (M)	6"	3/4"	255,000
OPT-BP1284RDE12	OPT-BP1284RDSSE12	84"	8"	72" (M)	6"	3/4"	300,000
OPT-BP1296RDE12	OPT-BP1296RDSSE12	96"	8"	84" (M)	6"	3/4"	350,000

Pan Material: Aluminum
 Burner Material: Brass / Stainless Steel
 Ignition Type: 12V Electronic Ignition
 (12V Transformer Included)

 **12V ELECTRONIC IGNITION**
 ANSI Z21.97-(2017) / CSA 2.41-(2017)

Includes: Pan, Burner, Electronic Valve,
 Pilot Igniter, 12V Transformer.

M = Manifold

RECTANGULAR DROP IN PAN & H BULLET BURNER 110V ELECTRONIC IGNITION

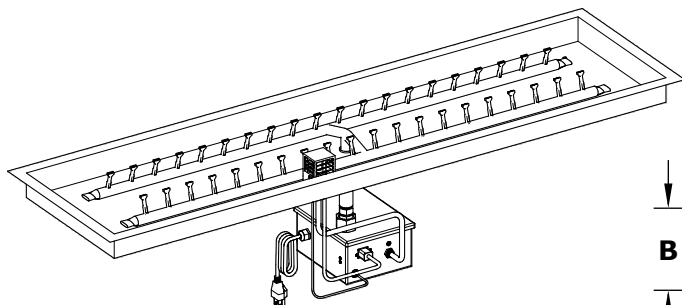

ISOMETRIC VIEW

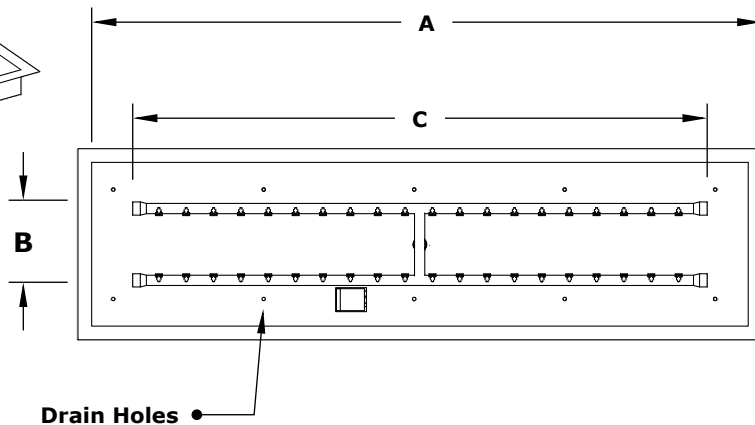

TOP VIEW

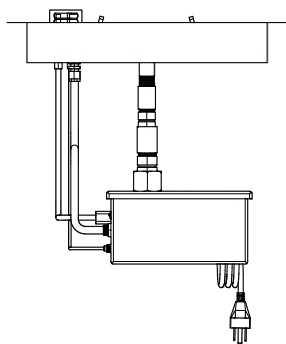

RIGHT SIDE VIEW

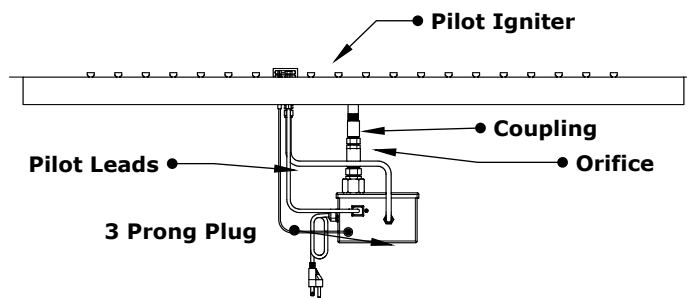

FRONT SIDE VIEW

Brass	Stainless Steel	A	B	C	D	INLET	BTU
OPT-BP1224RDE110	OPT-BP1224RDSSE110	24"	8"	18"	6"	1/2"	85,000
OPT-BP1236RDE110	OPT-BP1236RDSSE110	36"	8"	24"	6"	1/2"	110,000
OPT-BP1248RDE110	OPT-BP1248RDSSE110	48"	8"	36"	6"	1/2"	160,000
OPT-BP1260RDE110	OPT-BP1260RDSSE110	60"	8"	48"	6"	1/2"	205,000
OPT-BP1272RDE110	OPT-BP1272RDSSE110	72"	8"	60" (M)	6"	3/4"	255,000
OPT-BP1284RDE110	OPT-BP1284RDSSE110	84"	8"	72" (M)	6"	3/4"	300,000
OPT-BP1296RDE110	OPT-BP1296RDSSE110	96"	8"	84" (M)	6"	3/4"	350,000

Pan Material: Aluminum
 Burner Material: Brass / Stainless Steel
 Ignition Type: 110V Electronic Ignition
 (110V Transformer Included)

 **110V ELECTRONIC IGNITION**
 ANSI Z21.97-(2017) / CSA 2.41-(2017)

Includes: Pan, Burner, Electronic Valve,
 Pilot Igniter, 110V Transformer.

M = Manifold