

Models:
SCKVP-B
Natural Gas to Propane
Conversion Kit

GAS-FIRED



This conversion kit has been tested for use with specific Heatilator gas appliances. Check with your local building code agency before you begin installation to ensure compliance with local codes, including the need for permits and follow-up inspections. If you encounter any problems regarding code approvals, or if you need clarification of any of the instructions contained here, contact your dealer. For the dealer nearest you, please visit www.heatilator.com.

HEATILATOR® is a registered trademark of Hearth & Home Technologies Inc.

Note: Gas conversions should only be performed by a qualified service person, and/or where required by state and local codes, licensed installer/service technician. In the Commonwealth of Massachusetts, installation must be performed by a licensed plumber or gas fitter.

Note: This kit is for a one time conversion only. Discard unused parts.

Note: An arrow (➡) found in the text signifies change in content.

A. Components

| Description | Part # |
|--|-------------|
| Burner Orifice | See Table 1 |
| Pilot Orifice .014 in. | 29477 |
| Variable Regulator 6.3 in. - 10.0 w.c. | 230-1520 |
| SCKVN-B/SCKVP-B Label | 4016-129 |

Tools Required:

- Phillips screwdriver
- Straight screwdriver
- Pliers
- Non-corrosive leak-check solution
- 1/2, 5/8 & 7/16 wrench
- Manometer

| Table 1 | | |
|----------------|-------|----------|
| Burner Orifice | | |
| Model | Size | Part # |
| GDST60 | 0.067 | 17812 |
| GDFL60 | 0.067 | 17812 |
| GDCR60 | 0.067 | 17812 |
| GDCL60 | 0.067 | 17812 |
| GDCH60 | 0.067 | 17812 |
| GBST36 | 0.067 | 17812 |
| GBCR36 | 0.067 | 17812 |
| GBCL36 | 0.067 | 17812 |
| GBFL36 | 0.067 | 17812 |
| GNTC50 | 0.056 | 13845 |
| CD4236R | 0.065 | 4021-062 |
| CD4842R | 0.067 | 4021-198 |
| ND3630 | 0.052 | 4031-163 |
| ND3933 | 0.055 | 4031-164 |
| ND4236 | 0.058 | 4031-165 |
| ND4842 | 0.064 | 4031-162 |
| NB3630 | 0.052 | 4031-163 |
| NB3933 | 0.055 | 4031-164 |
| NB4236 | 0.058 | 4031-165 |
| NB4842 | 0.064 | 4031-162 |

CAUTION

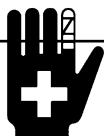



Sharp Edges

- Wear protective gloves and safety glasses during installation.



1 Gas Conversion Instructions

| | | |
|--|----------------|---|
|  | WARNING |  |
| Fire and/or Explosion Risk | | |
| <ul style="list-style-type: none">• Shut off gas.• Orifices must be replaced | | |
| <p>Failure to shut off the gas supply prior to disconnecting gas supply could result in explosion of gas fumes.</p> <p>Failure to replace the orifices could result in overheating the gas appliance and possibly damaging your appliance and your home.</p> | | |

Note: Remove all components blocking your access and set aside.

A. Gas and Power Supply

- Locate the gas manual shutoff valve in the control area in the bottom of the appliance. Turn the shutoff valve so it is perpendicular to the gas line.
- If electricity has been brought to the appliance, shut off all power by turning off the appropriate circuit breaker or removing the fuse in the electrical panel.

B. Remove the Valve Assembly

Novus ND & NB Series

- Remove control access panel.
- Locate and remove the two wing nuts and the two wing screws holding the valve plate assembly to the firebox bottom.
- Grasp the valve plate assembly and slide to the left, then down to disengage the valve plate assembly and clear the wing studs in the rear.
- Rotate the valve plate assembly horizontally so the pilot assembly comes out first from the valve compartment. See Figure 1.1. Care should be used to not damage the pilot when removing the valve plate assembly.
- Go to Section 1.D. Burner Orifice.

Note: Inspect the valve plate gasket at this time and replace if worn or damaged. Contact your distributor/dealer customer services department for replacement parts.

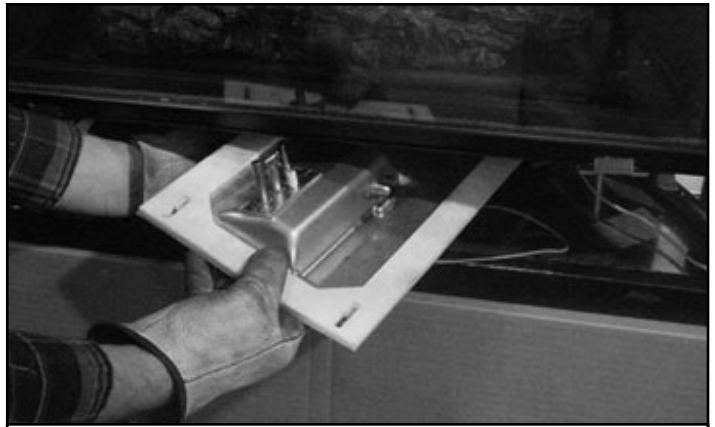

Figure 1.1 Valve Plate

C. Caliber CD Series and Caliber Designers Valve Access

- Remove the control access panel so you can observe the control area of your gas appliance.
- Remove the screen and glass frame assembly.
- Remove the Log Set (Designers)
 - Remove two screws, one at each end of the grate.
 - Pull the log/grate assembly up and off the burner.
- Remove the Log Set (CD Series)
 - Lift the two top logs off the log set. See Figure 1.2.
 - Remove the grate/log assembly by removing two screws as shown in Figure 1.2. Lift and pull grate/log assembly from front of firebox.
 - Remove four screws securing the rear log (Figure 1.3). Lift rear log and remove from firebox.
- Remove the main burner by removing four screws (Figure 1.3), one at each corner. Slide the burner to the left and lift out. Set aside.
- Designer burners will lift straight up or slide forward then up.

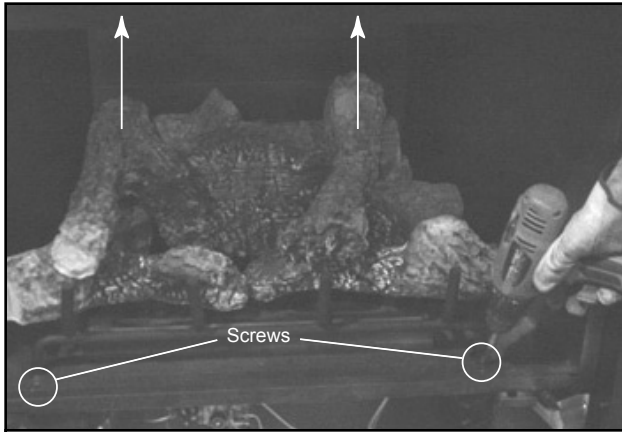

Figure 1.2 Loosen Grate

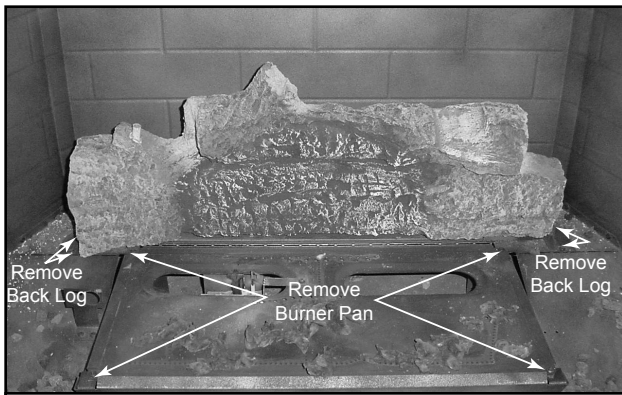

Figure 1.3 Remove Rear Log

D. Burner Orifice - Novus ND/NB & Caliber CD-Series

Use Table 1 and the existing rating label (located in the valve compartment) to determine the correct orifice for your appliance.

- For Caliber CD Series remove the two screws so air shutter cover can be removed. See Figure 1.4.
- For Novus, Caliber & Designers: Using a 1/2 in. wrench, remove the threaded orifice (see Figure 1.5), discard and replace with the appropriate orifice. Make sure the orifice is screwed on completely. Failure to have the orifice completely screwed on will result in the valve plate assembly not fitting together properly.
- Replace air shutter cover (CD Series).

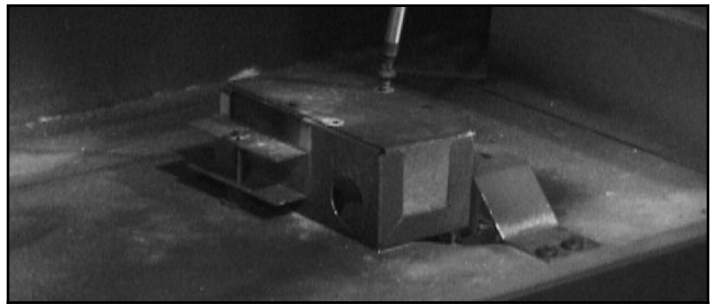

Figure 1.4 Remove the Air Shutter Cover

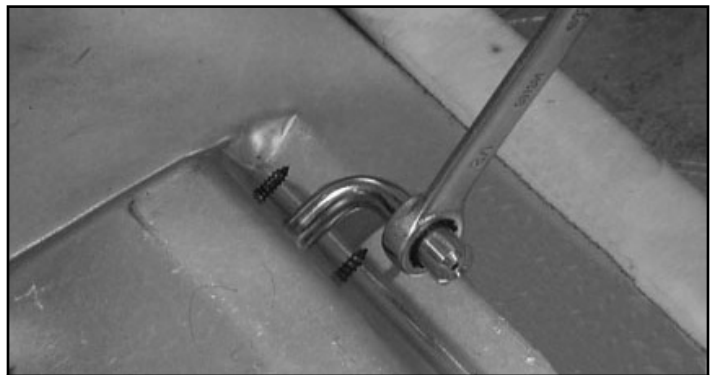

Figure 1.5 Remove the Burner Orifice - Novus ND/NB Series



Figure 1.6 Loosen the Retaining Nut - Caliber

C. High Altitude Installation

U.L. Listed gas appliances are tested and approved without requiring changes for elevations from 0 to 2000 feet in the U.S.A. and Canada.

When installing this appliance at an elevation above 2000 ft, it may be necessary to decrease the input rating by changing the existing burner orifice to a smaller size. Input rate should be reduced by 4% for each 1000 ft above a 2000 ft elevation in the U.S.A., or 10% for elevations between 2000 and 4500 ft in Canada. If the heating value of the gas has been reduced, these rules do not apply. To identify the proper orifice size, check with the local gas utility.

If installing this appliance at an elevation above 4500 ft (in Canada), check with local authorities.

D. Pilot Orifice

- Secure the bracket of the pilot assembly and loosen the nut with a 7/16 in. wrench.
- Loosen the nut until the pilot hood becomes loose from the pilot assembly. See Figure 1.7.
- The orifice is inside the base of the pilot assembly. See Figure 1.8.
- Discard the existing orifice and replace with the pilot orifice from this kit.

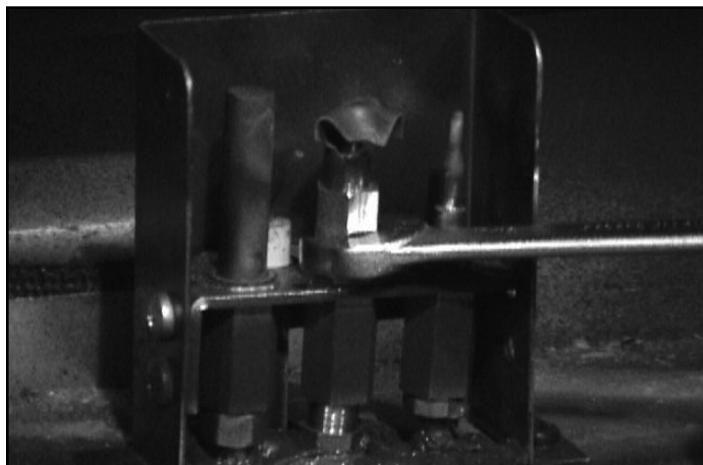

Figure 1.7 Loosen the Pilot Hood (CD & Designer Series)

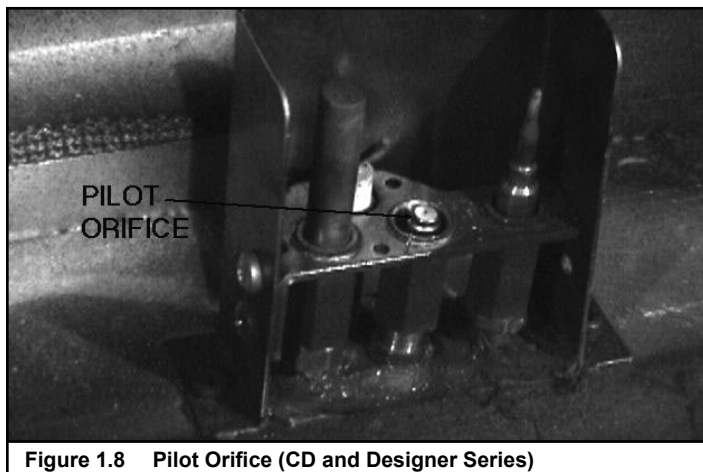

Figure 1.8 Pilot Orifice (CD and Designer Series)

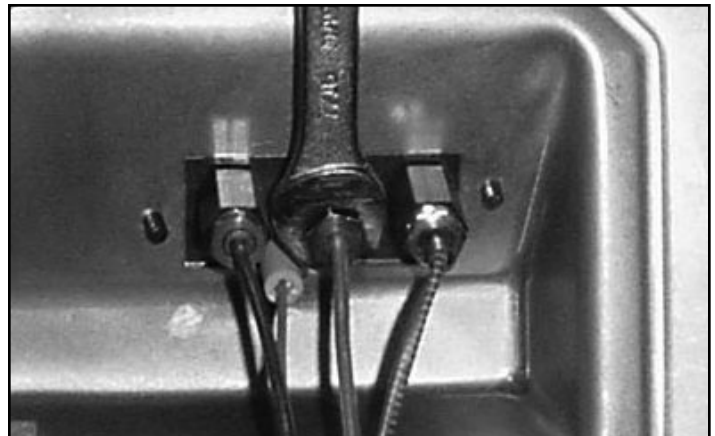

Figure 1.9 Pilot Orifice (Novus Series)

E. Novus ND/NB Series Reinstallation

- Replace valve assembly. Refer to Section 1.B.
- Replace control access panel.

F. Caliber CD & Designer Series, Reinstallation

- Replace the burner assembly.
- (CD Series only) Replace the log set. The rear log must be installed using the back set of holes are used when converting to propane. See Figure 1.10.

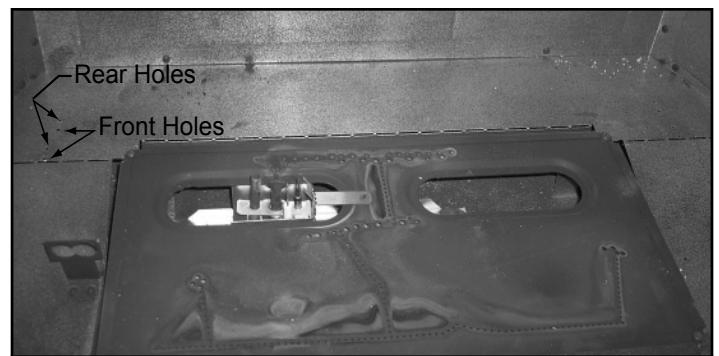

Figure 1.10 Reinstall Rear Log Location

- Replace screen and glass frame assembly.
- Replace control access panel.
- Refer to Section 1.C.

2 After the Conversion

A. Adjustable Regulator

- To gain access to the valve regulator, open the control access cover or panel.
- Follow the instructions steps 1-3 that are included with the regulator. Save the label included in the kit for later attachment to the appliance. See Figures 2.1 and 2.2.

B. Leak Check

- Turn on the gas supply to the appliance. All connections must be tightened and checked for leaks with a commercially available, noncorrosive leak check solution. Be sure to rinse off the solution when done leak testing.
- Turn the gas control knob to the "PILOT" position. Push the knob in all the way and hold. At the same time, push in the red ignition button repeatedly until the pilot lights. **NEVER** hold in the gas control knob for more than ten seconds if the pilot does not light.
- Once the pilot lights, continue to hold in the control knob for fifteen seconds. Release the gas control knob and it will pop back up. Test for leaks at the pilot assembly.
- Turn the gas control knob to the "ON" position and turn the switch on. Check for leaks around the valve and the burner orifice with a commercially available, noncorrosive leak check solution. Be sure to rinse off the solution when done leak testing.

C. Pressure Check

The gas input, inlet pressure and manifold pressure must be as indicated on the rating label located on the bottom pan, near the valve.

- Verify that the valve gas control knob is set at the "PILOT" position. This is important to prevent accidental gas leaks during the pressure test.
- Using a small flat head screwdriver, completely loosen the screw inside the pressure tap that you want to check. The screw does not need to be removed.
- Place a 3/8 in. diameter tube from the manometer over the pressure tap.
- Turn the gas knob to "ON" and the burner ON/OFF switch to "ON". The burner needs to be on to check the outlet (manifold) pressure.
- Turn the burner switch to "OFF" and the valve knob to "PILOT". Disconnect the tubing and tighten the screw in the pressure tap.

D. Verify Operation

- Turn the gas knob to "ON" and the switch to "OFF".
- Verify that the burner lights.
- Turn the control knob clockwise and counterclockwise to confirm the flame adjusts up and down.
- Let the appliance run for fifteen minutes, allowing the flame to reach its height and color.

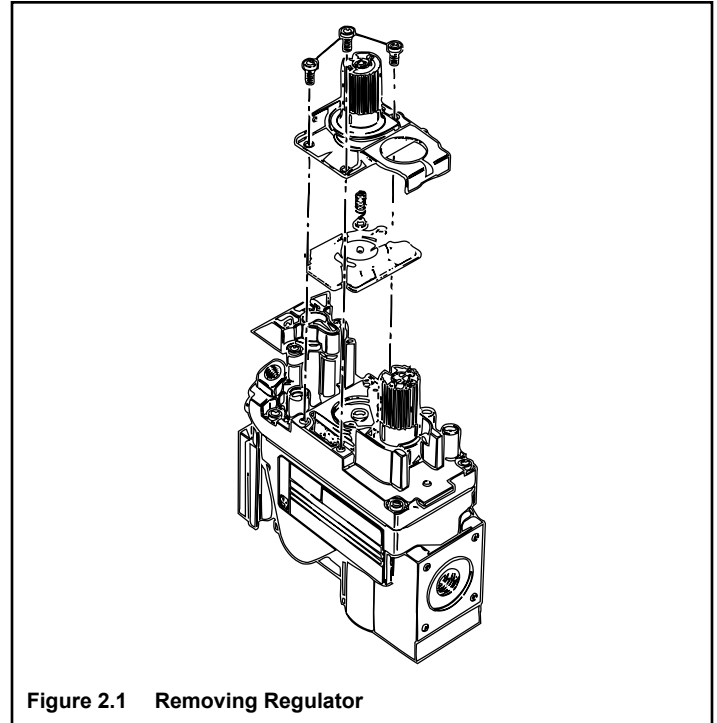

Figure 2.1 Removing Regulator

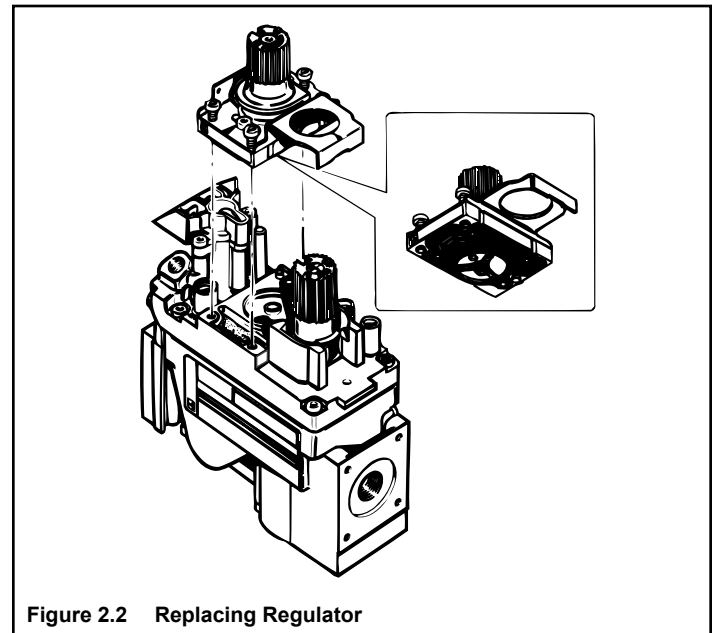
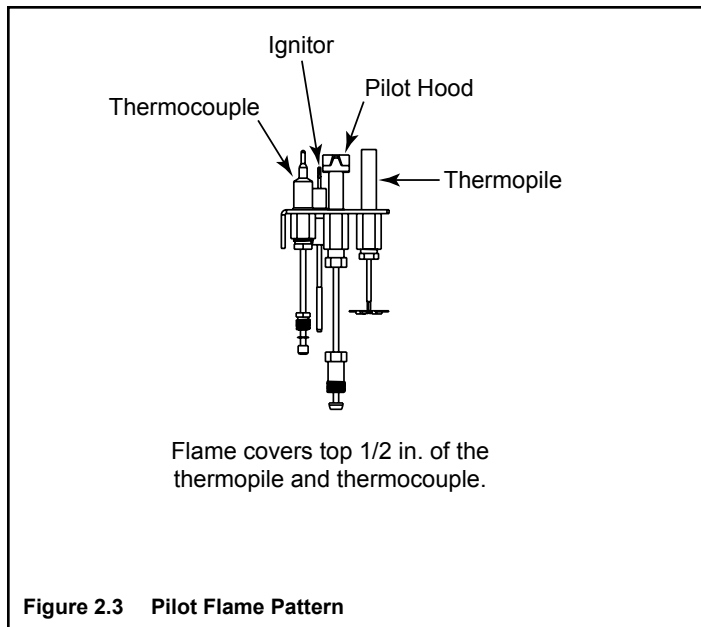

Figure 2.2 Replacing Regulator

E. Check the Flame Patterns

Look at the flame of the burner, making sure the flames are steady, not lifting or floating. The flame color should be blue with yellow tips. The thermopile tip (standing pilot) should be covered in flame. See Figure 2.3.



F. Air Shutter Adjustment (CD & Designer Series)

The air shutter adjusts the amount of air that mixes with the gas as it enters the burner pan.

- Locate the wing nut underneath the firebox bottom. See Figure 2.4. To close the air shutter, turn the wing nut clockwise. To open the air shutter, turn the wing nut counterclockwise. The air shutter is used to fine-tune the flame as necessary for differences in altitude and vent configuration. The air shutter fully open for LP appliances.



- Allow the appliance to operate 15-20 minutes. This will give the flame time to reach its height and color before making adjustments to the air shutter. As the air shutter is closed, the flame should be taller and darker.

- The appliance may produce a noise, caused from metal expansion and contraction as it heats up and cools down. This noise is similar to one that a furnace or heat duct may produce and does not affect the operation or longevity of the appliance.

G. Air Shutter Adjustment (Novus ND/NB Series)

- Locate the burner tube in the valve compartment. See Figure 2.5.
- Loosen the 1/4 in. nut using a nut driver or stubby screwdriver. The air shutter should be adjusted to 3/8 in. open for 30 & 33 in. appliances, fully open for 36 & 42 in. appliances.
- Tighten the nut to lock the air shutter in position.

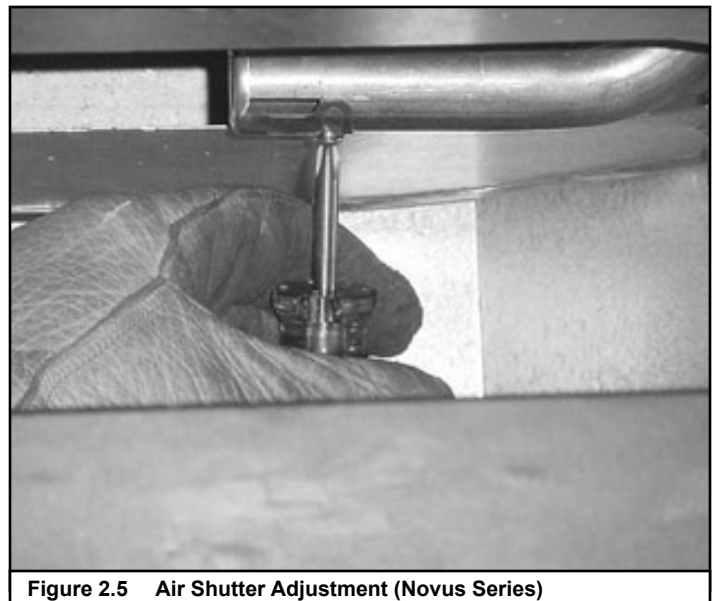

H. Affix the Labels

- Attach the label included with the regulator kit on either the valve or visibly adjacent to the valve. This label reads: "This control has been converted to propane."
- Attach the installer conversion label included with this kit in a visible location on or near the appliance after the appropriate information has been added to the label.

I. Reconnect Electric Supply

- Restore power by turning on the appropriate circuit breaker or putting a fuse back into the electrical panel.