

# WALL MOUNTED STUDIO SUITE DISPLAY FOR THE ORION MULTI

## Owner/Installation Guide

Covers Part Numbers:

**WSS-ORxx-xx**

52-60-76

CS-DW-RTF-WW



## HOW TO INSTALL VIDEO



# Assembly, Parts & Hardware List

## What's in the Box

- Instruction Guide.



- Power Cord.



- Cabinet Bracket, Right P/N: 02-00524.

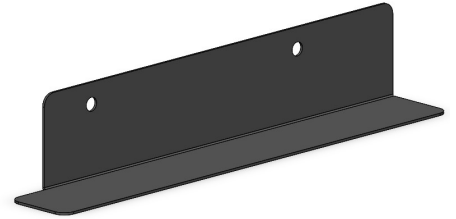

- Side Skirt P/N: 02-00526.

(Ships installed on fireplace or with fireplace)



- Top/Bottom Orion Cabinet Suite.

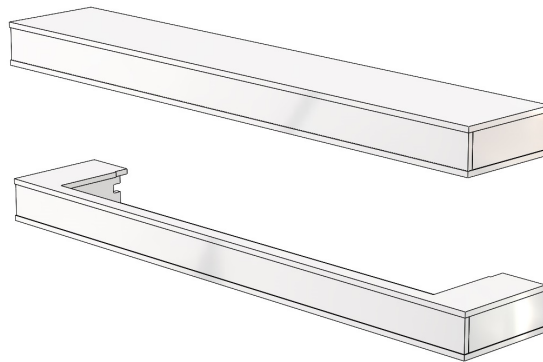

- Cabinet Bracket, Left P/N: 02-00525.

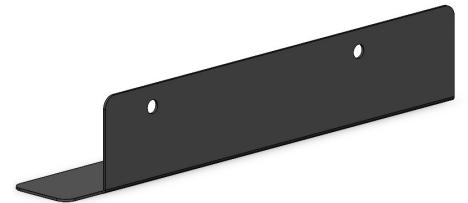

- Drywall Stop P/N: 02-00645.

(2 per fireplace ships with fireplace).



- Size-Specific Wall Mount Bracket. (Ships installed on back of fireplace).

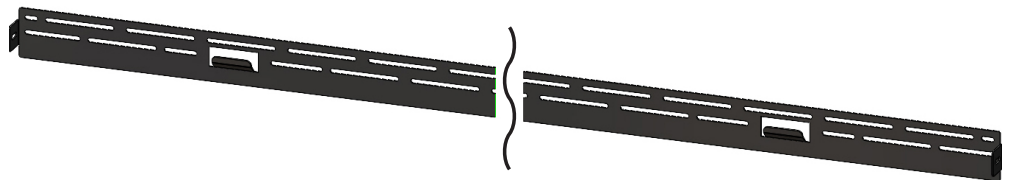

- Hardware Kit: Image is example only.

#8x1" Screws



#8x1-5/8" Screws



#Hollow wall anchors



# Assembly, Parts & Hardware List

Verify you have the correct suite for your fireplace  
by checking the part number.



## EXAMPLE OF FINISH

(RTF is a ready-to-paint white primer finish, not shown.)



# Installation and Assembly

## Installed suite dimensions

- ❑ 52in Orion Version = 64.5" W x 30.5" H x 11.25" D.
- ❑ 60in Orion Version = 73" W x 30.5" H x 11.25" D.
- ❑ 76in Orion Version = 87.81" W x 30.5" H x 11.25" D.

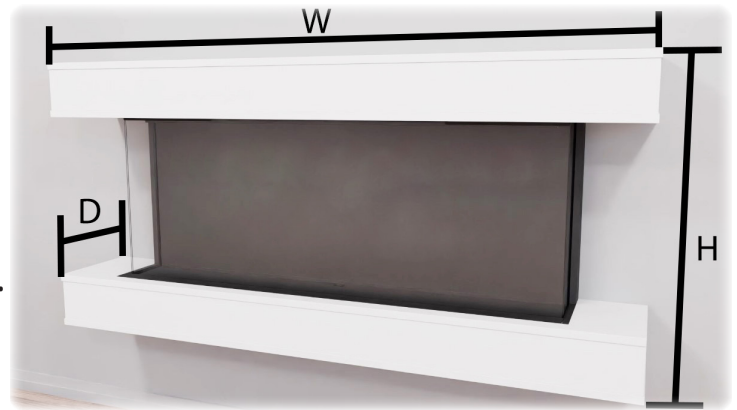

- 1 Select a suitable location for your installation while taking into consideration the type of installation, the running of your electrical, and the overall size of the finished installation.



- 2 Unpack and separate the contents of the Wall Mounted Studio Suite for the Orion Multi. Reference page 2 to verify the contents. For any content that is missing, contact Modern Flames customer service at 1-877-246-9353 or via email at [customerservice@modernflames.com](mailto:customerservice@modernflames.com).

# Installation and Assembly

- 3** Remove the side skirts on the left and right sides of the fireplace. The skirts and screws will be reused.



- 4** Remove the left and right side covers to reveal glass panels by removing the screws on each side of your fireplace. Do not discard screws as they will be reused.

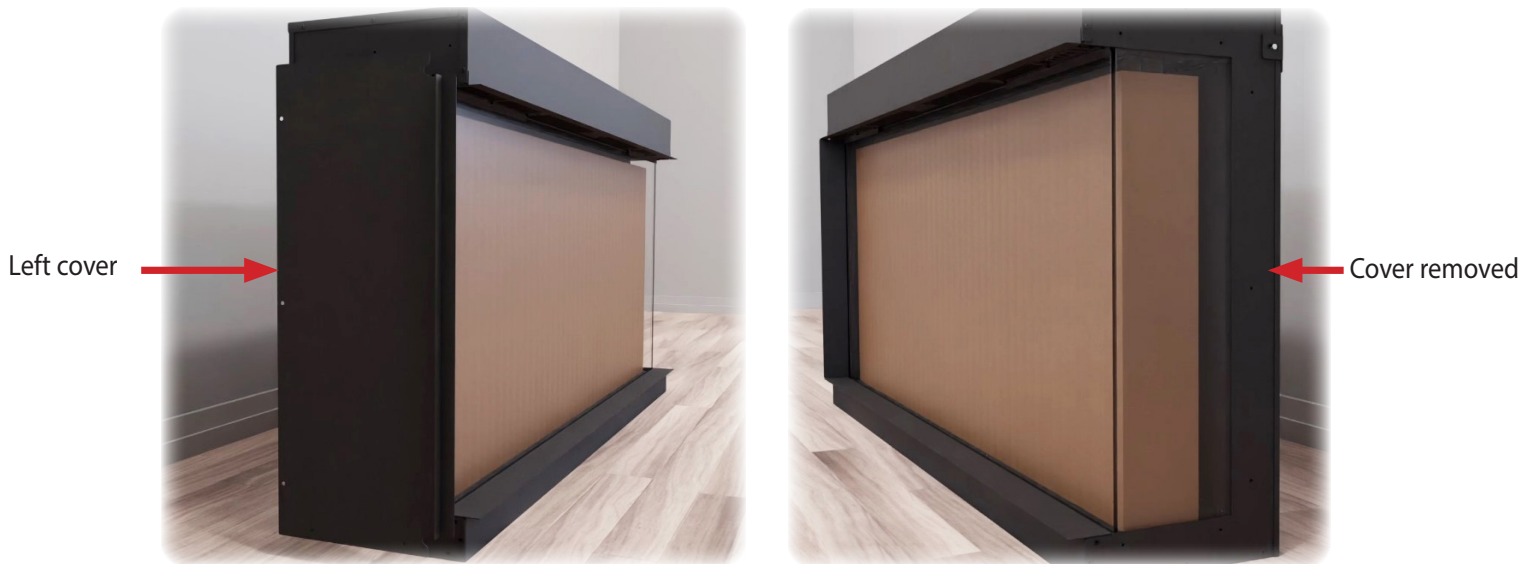



# Installation and Assembly

- 5** Remove the front glass by unscrewing the securing brackets located on the top front of the glass, one on the left and one the right.



Left side bracket



Right side bracket

- 6** Carefully tilt the top edge of the glass and away from the fireplace and lift to fully remove it, place the glass aside in a safe location to prevent any damage.



- 7** Take out the hardware and media box from viewing area of the fireplace then locate the side drywall stops P/N: 02-00645.

# Installation and Assembly

- 8 Set up the fireplace by installing the side drywall stops on each side. Use the same screws you previously removed from side covers.



Left drywall stop



Right drywall stop

- 9 Install the side skirts by aligning it to the drywall stop and reinstalling the previously screws.



Left side skirt



Right side skirt

# Installation and Assembly

**10** Install cabinet mount brackets to all four corners.



Upper left bracket



Upper right bracket



Lower left bracket

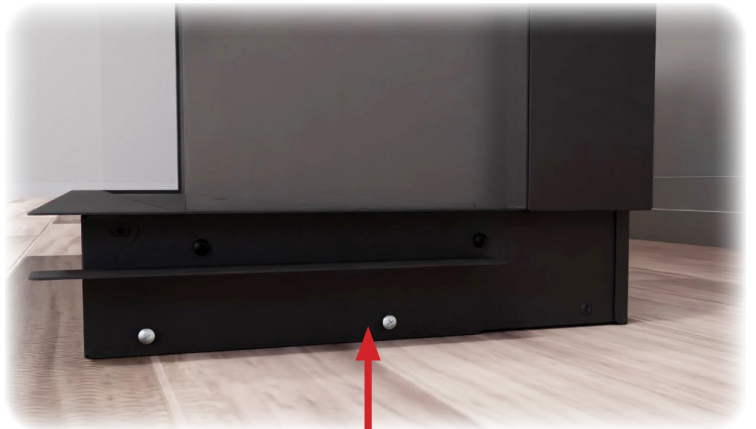

Lower right bracket

**11** If using the power cord, attach the power cord to the fireplace going through the top access on the back right of your fireplace. Connect the power cord hot connection (black wire) to L1 on the fireplace terminal block, the power cord neutral connection (white wire) to N on the terminal block, and the ground wire (green wire) to the ground on the terminal block.



# Installation and Assembly

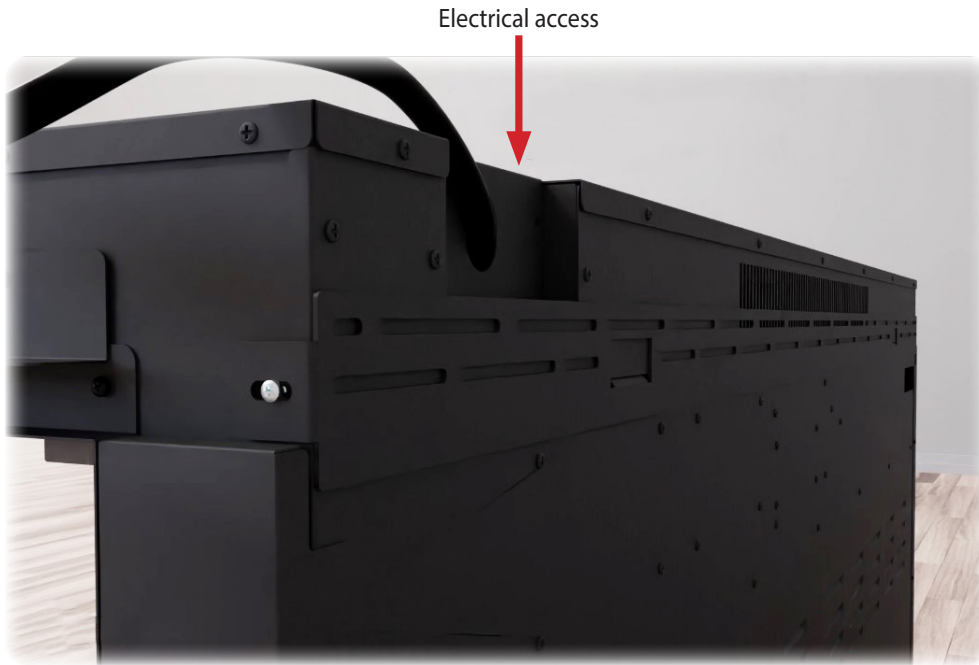

 **TURN OFF POWER FROM CIRCUIT BREAKER FIRST**

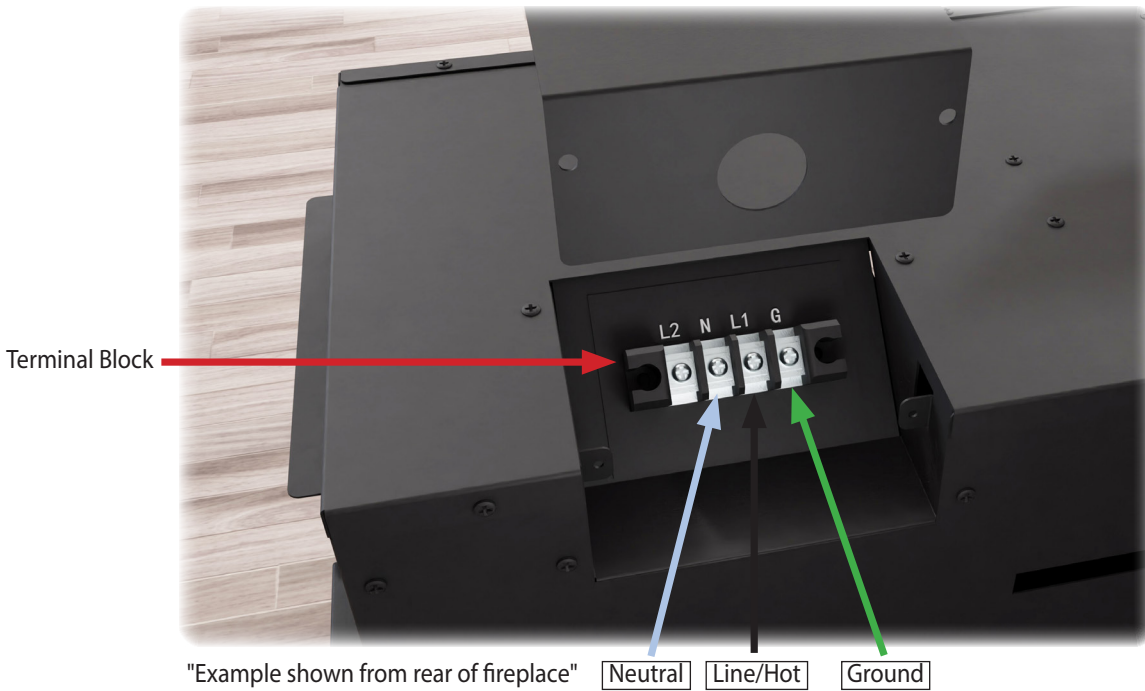

# Installation and Assembly

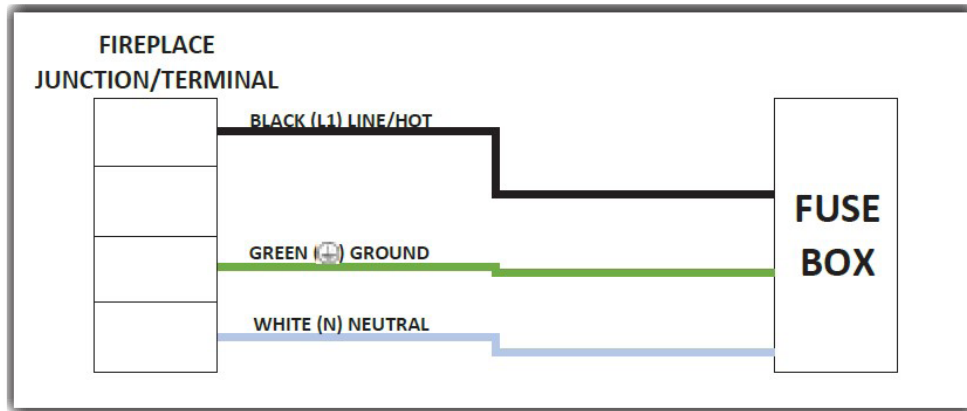

- 12** Locate the studs on the wall to install the size-specific wall mount bracket. You must be able to secure a minimum of 2 studs for proper installation and as close to the end of the bracket as possible. The hollow wall anchors provided are only for additional support between studs. To assist in locating the fireplace bracket on the wall, measure from the top of the bracket to the top of the fireplace. After locating the top placement of the fireplace on the wall, measure down using the previous measurement and mark the location. This will be the top location of the bracket for mounting purposes. The wall mounting bracket can now be removed. Do not discard screws. With the wall mount bracket removed from the fireplace, press it against the wall and line it up with the previous location mark. Ensure to level the bracket and mark any slots that will be used for securing the bracket to the wall.

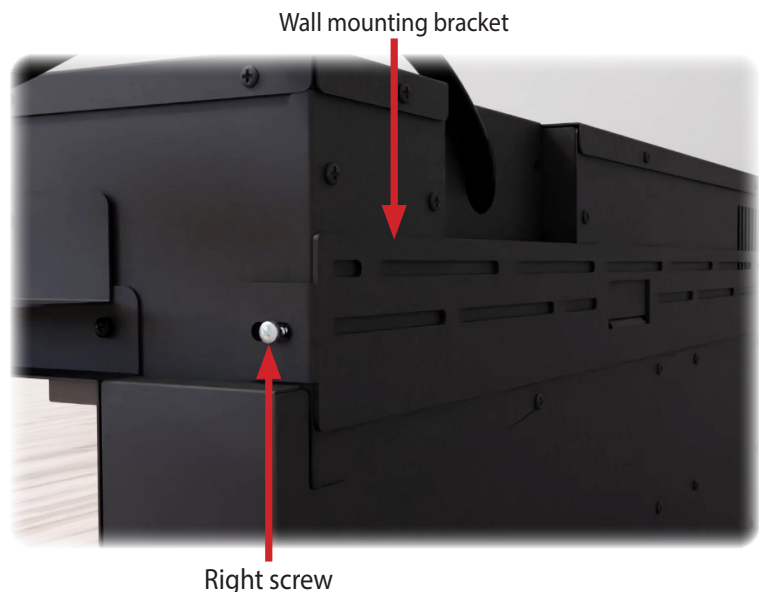
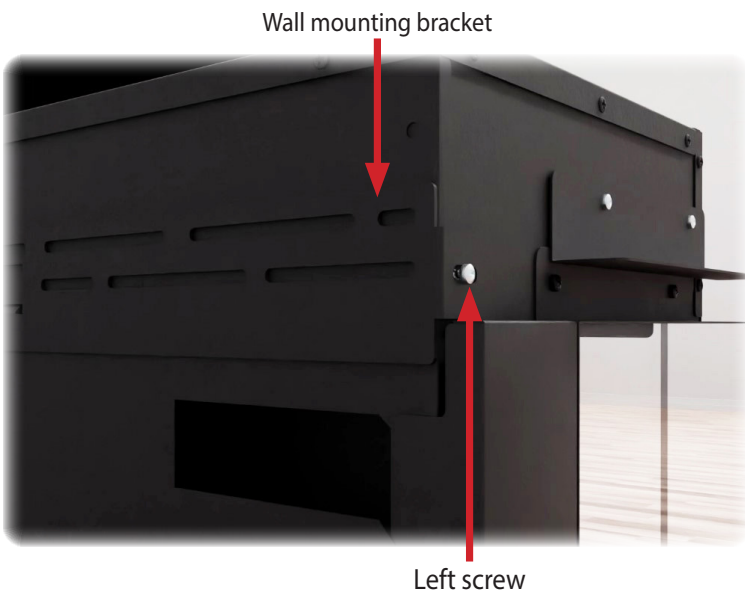

# Installation and Assembly

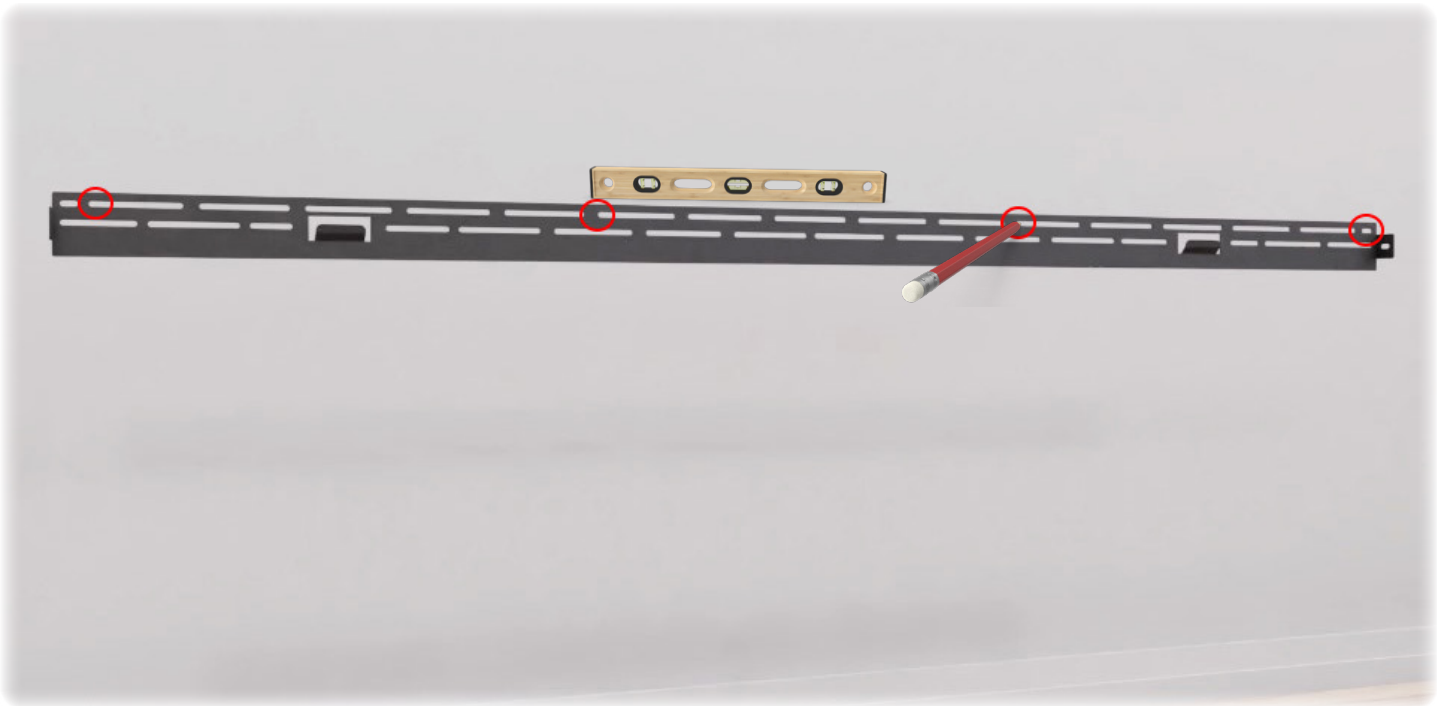

# Installation and Assembly

- 13 Align the bracket with the marks previously made and mount the bracket to the wall. Note:
- It is recommended to pre-drill mounting holes before installation with a 7/64" drill bit (not included).
  - The hollow wall anchors will need to be installed before the wall mounting bracket.
  - It is recommended that the anchors be installed with a Phillips tip screwdriver for proper installation.

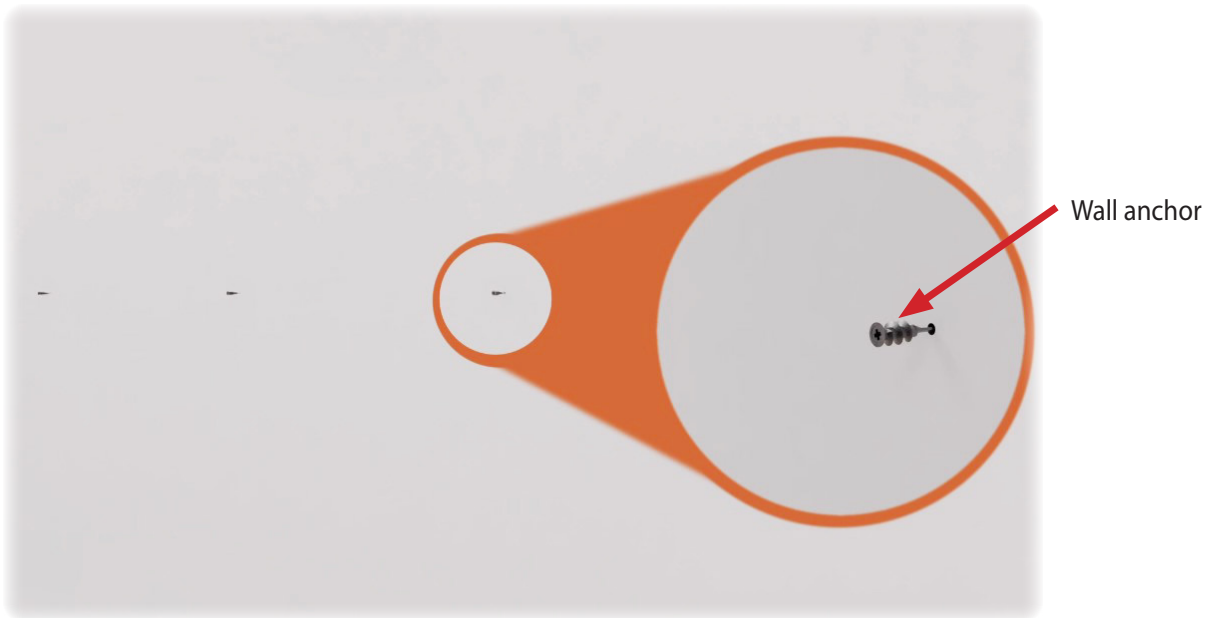
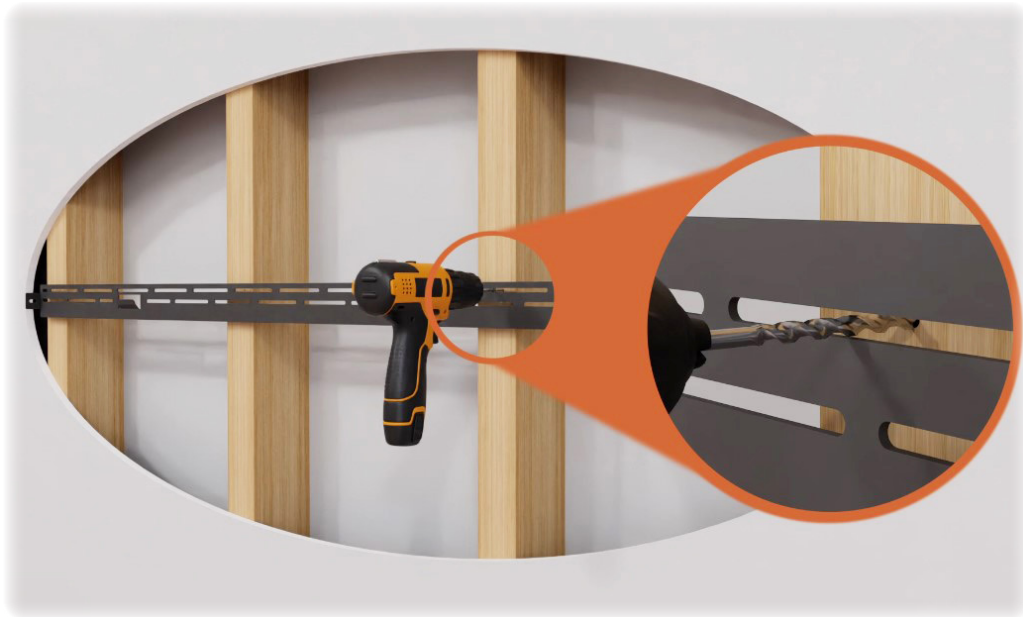

# Installation and Assembly

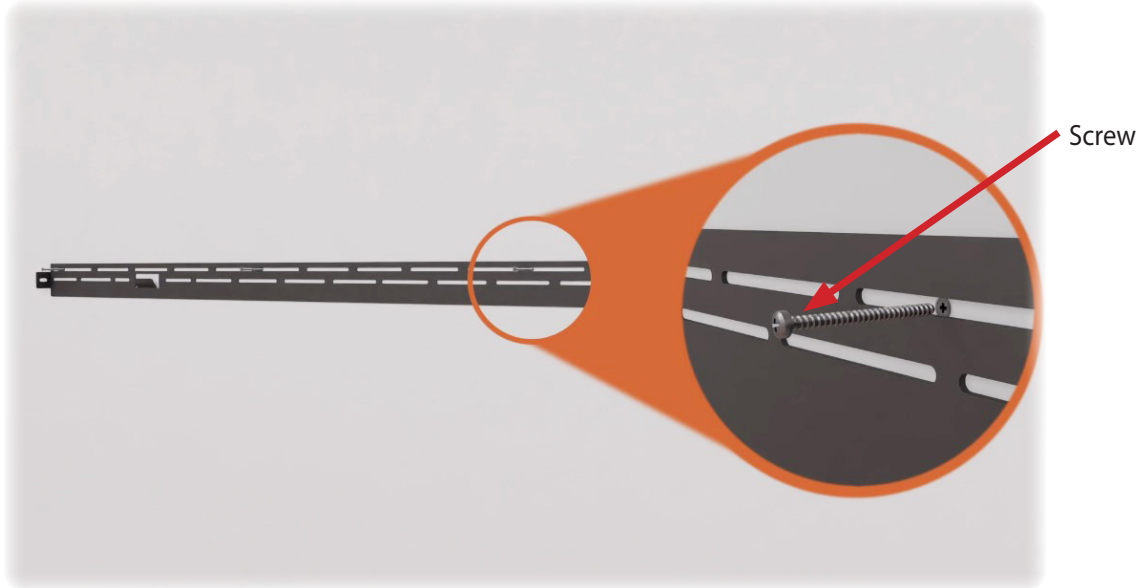

- 14** Run a hardwire line or locate an outlet 2.25" from the right side of the bracket to the center of the outlet. The space where the outlet can be installed measures: 4" W x 4.5" H. Outlet position can be horizontal or vertical.





# Installation and Assembly

- 15 With the wall mounting bracket installed, lift the fireplace onto the wall mount bracket, ensuring all hooks on the bracket secure into the fireplace. Quantity of hooks varies the size.



# Installation and Assembly

- 16 Secure the fireplace to the wall mounting bracket by re-inserting the previously removed screws.

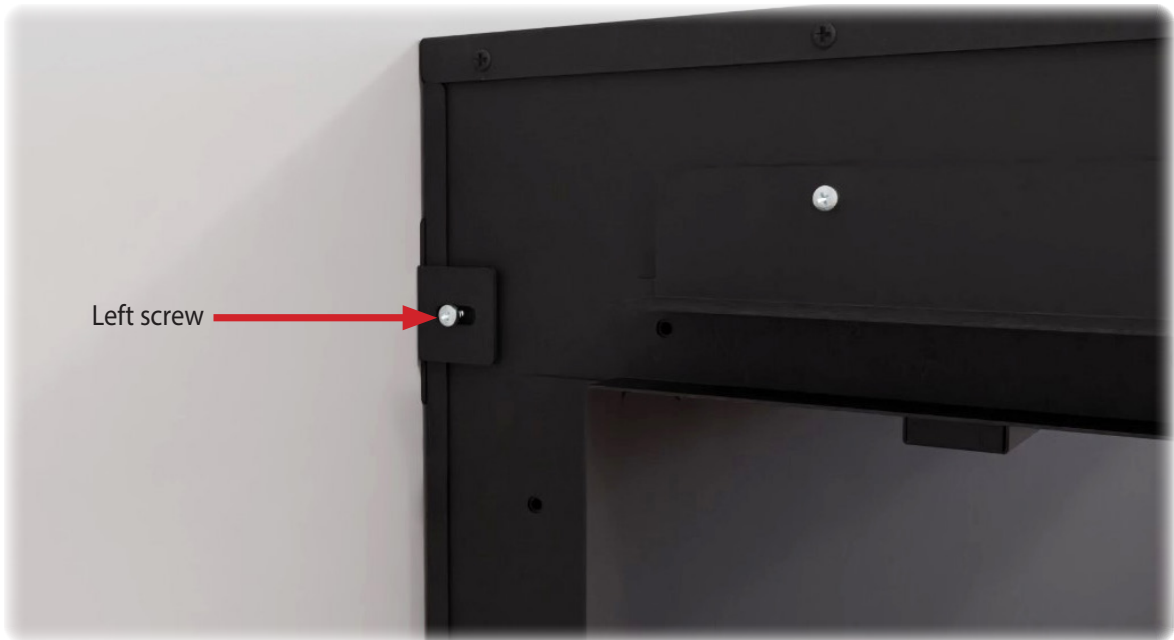
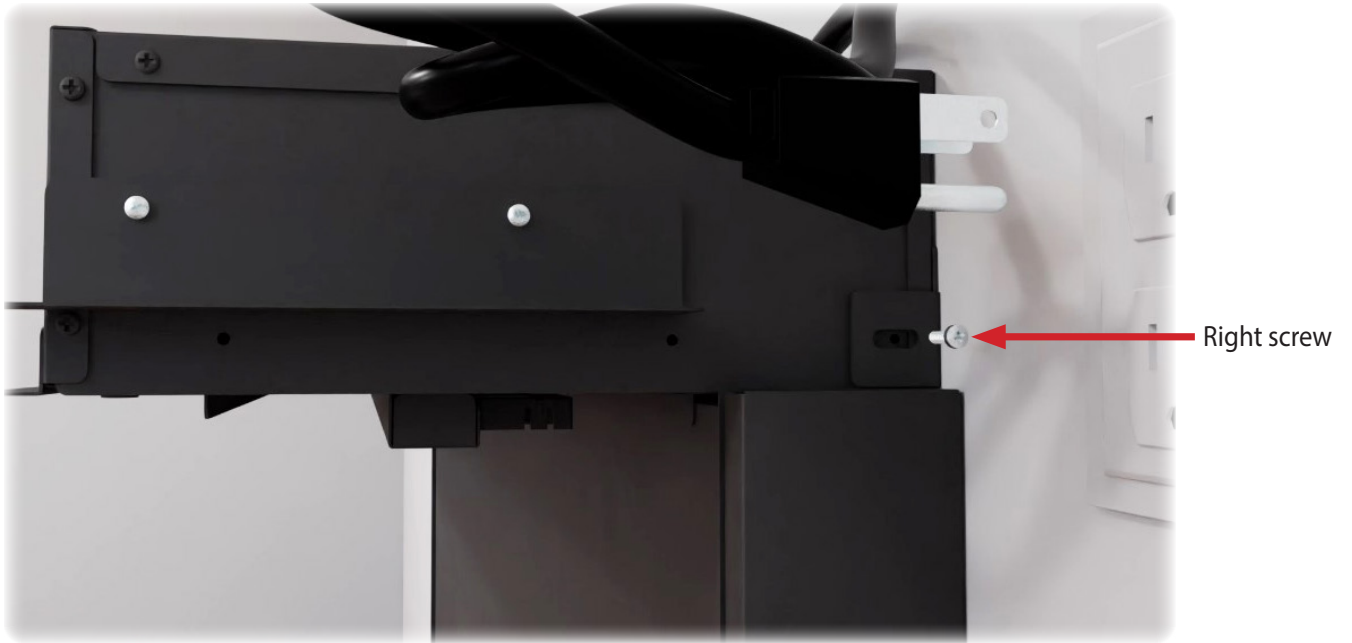

# Installation and Assembly

- 17 Power cord can now be connected to the outlet. Secure excess cable.



- 18 Fireplace media and glass can now be installed. Reference the fireplace manual for details.

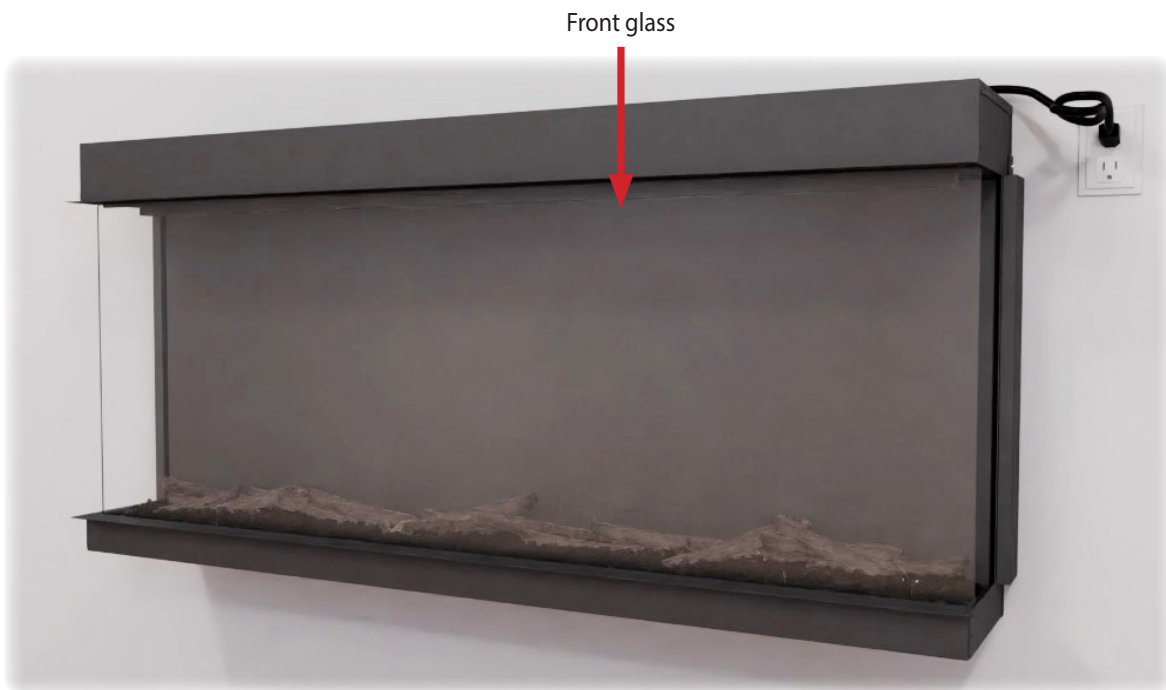

# Installation and Assembly

- 19 Evenly slide the bottom suite onto the fireplace by sliding it between cabinet mount brackets and drywall stops. If binding occurs ensure it is being inserted evenly and level.



# Installation and Assembly



20

Evenly slide the top suite onto the fireplace by sliding it between cabinet mount brackets and drywall stops. Tuck any excess power cord wire in the cabinet cavity to ensure the top is fully inserted. If binding occurs ensure it is being inserted and leveled.





# Installation and Assembly



21

Installation complete. Note, the Studio suites for the Orion Multi fireplace are simply slid in place for ease of installation. No additional screws or adhesive are required for the installation of the suite tops and bottoms. A silicone caulking can be used to finish where the suites meet the walls but it is not required.



# DO NOT RETURN TO STORE! CALL US FIRST

For immediate help with installation, product information  
or if your product arrives damaged,

please call our toll free number at:

1-877-246-9353

(Monday - Friday, 8:00AM - 5:00PM, AZ Mountain Time)

Or email us at:

[customerservice@modernflames.com](mailto:customerservice@modernflames.com)

OUR STAFF IS READY TO PROVIDE ASSISTANCE

# MODERN FLAMES

Thank you for choosing Modern Flames, we appreciate all our customers and hope you have many years of enjoyment of our products.

Take a look at our other products from our RPG Brands family of companies



[GrandCanyonGasLogs.com](http://GrandCanyonGasLogs.com)

For all your indoor, outdoor gas fireplaces & fire feature products.



[Wildfireoutdoorliving.com](http://Wildfireoutdoorliving.com)

For all your outdoor living products, such as grills, refrigerators and accessories.



 Digital Copy

02282023

## RPG BRANDS

RPG BRANDS FAMILY OF COMPANIES

