

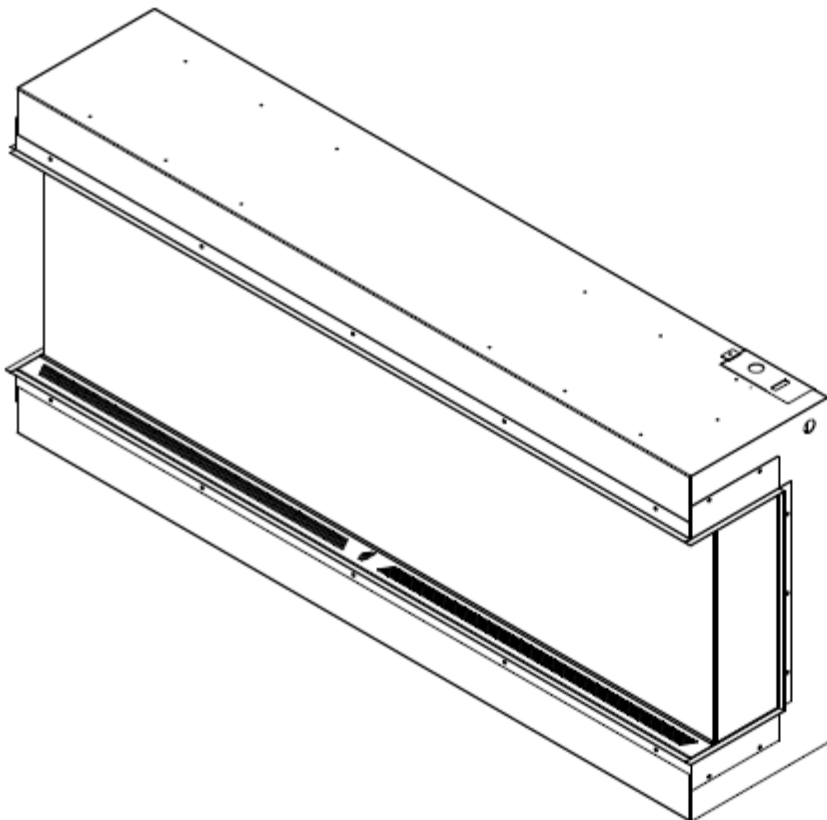

Multiview Wifi Instructions

For Android Users

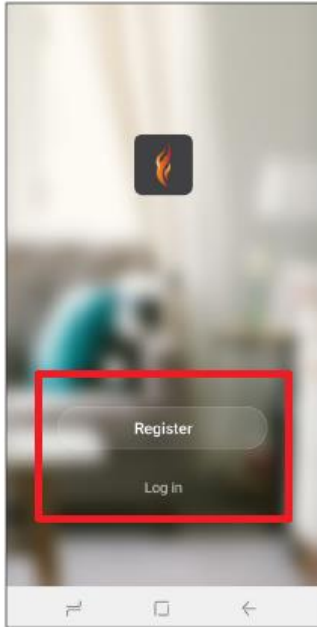



1. Get started by downloading the Modern Flames app from the Apple App Store or the Google Play Store. New users will need to register. Existing users can log in.

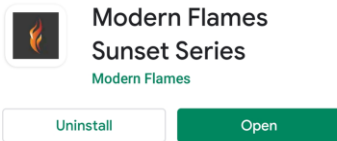

Android App is labeled as the name to the left in the store.

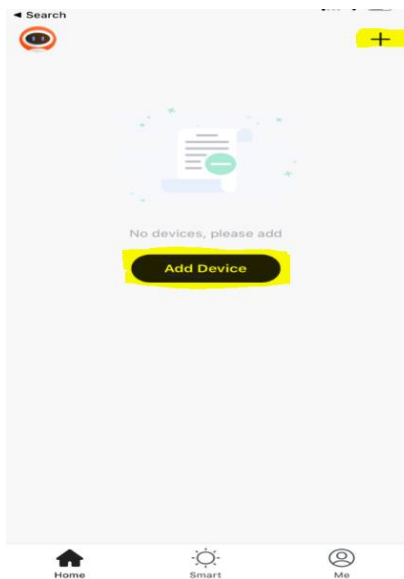

3. You will be able to add device by pressing the '+' on the top right or on the main button in the middle.

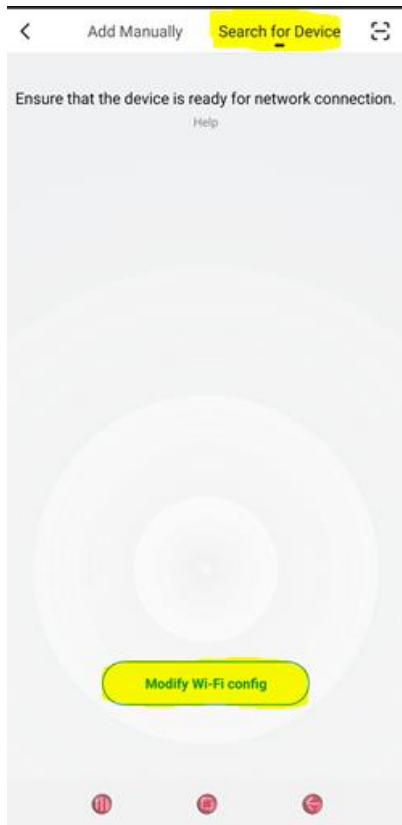

4. Click on 'Search for Device' at the top of screen.

-Note the 'Modify Wi-Fi Config' button at the bottom, press to insert Wi-Fi information and change to 2.4ghz.

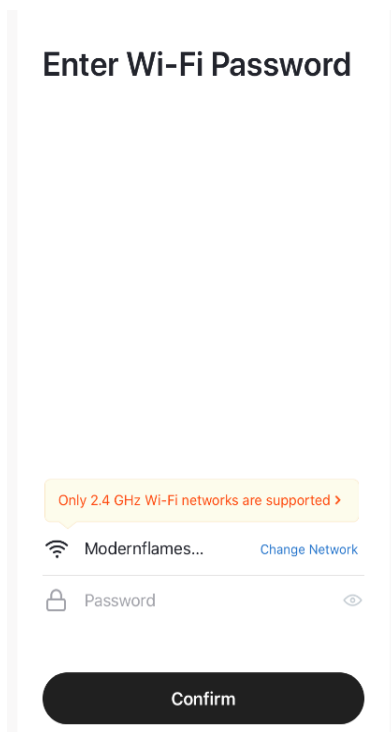

5. Insert Wi-Fi info at the bottom and change network to 2.4 ghz. Once entered hit 'Confirm' you will move onto the next step.

Add Device

Power on the device and confirm that indicator light rapidly blinks

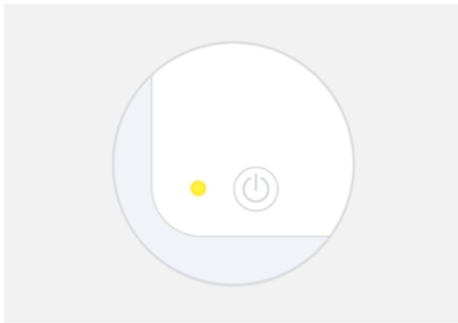

Help

Confirm indicator rapidly blink

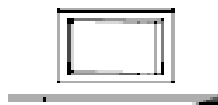

Power

Heater

Light

Power Switch

6. When you are back on this image locate the controls on the fireplace. Turn on unit with power button. Then press and hold the third button, light control, for a few seconds.

-You will hear an audible beep, release button and the lights will begin flashing.

-Once flashing press 'Confirm Indicator Rapidly Blink' button.

7. At this point the unit and mobile device should be linked. And the fireplace will turn back on. Select 'Next' to finish synching. This may take a few seconds.

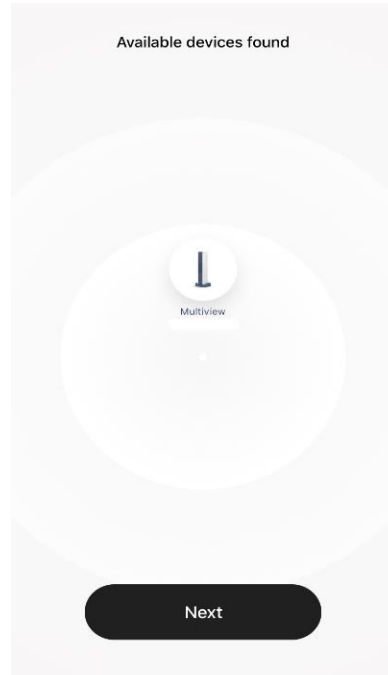

8. The next screen should give you access to the remote that will control this fireplace.

-You will have light control, color and dim.

-Thermostat control for the heat along with high and low settings.

-Dim and bright are controlled by the power bar in the middle.

-Each light zone is controlled at the top and they can sync together as well.

