

2

1

POWER REQUIREMENTS	VOLTS		AC 120 v @ 60Hz
	BATTERY BACKUP		4+ aa BATTERY 6v
LAMPS	LED 5v RGB		WS2811 DIODES
	IR REMOTE CONTROLLER		
	CUSTOMIZABLE WIFI APP		
PROFLAME II SYSTEM	5 LEVELS OF FLAME INTENSITY		
	REMOTE CONTROLLED IGNITION		
	VENTFREE OR VENTLESS CONFIGURATION		
	OXYGEN DEPLETION SENSOR		
HEATING OUTPUT	MAXIMUM HEAT	95,000 BTU/hr	27.84 kW
	MINIMUM HEAT (EN)	60,000 BTU/hr	17.58 kW
	MINIMUM HEAT (EP)	40,000 BTU/hr	11.72 kW

NOTE:
EN- NATURAL GAS
EP- PROPANE

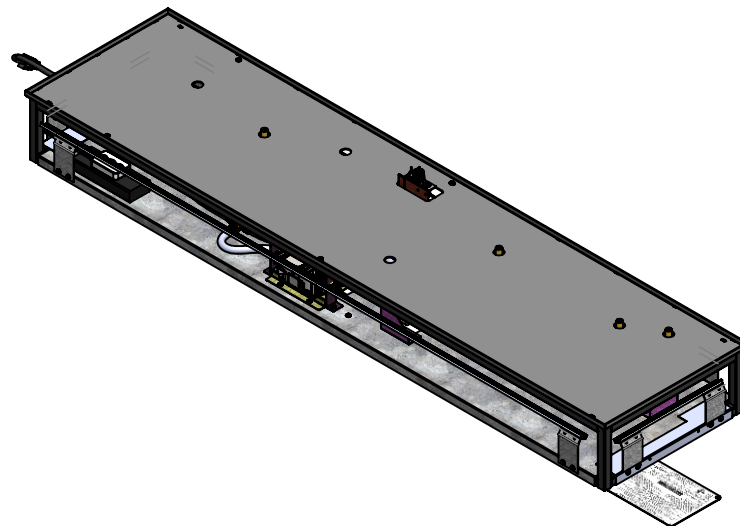

B

B

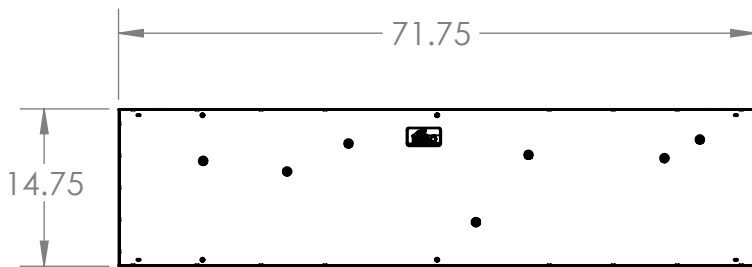

MINIMUM FIRE BOX DIM. (INCHES)		
WIDTH	DEPTH	HEIGHT
72	15	20

A

A

LEFT VIEW

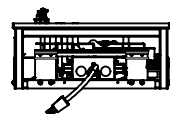

POWER OUT

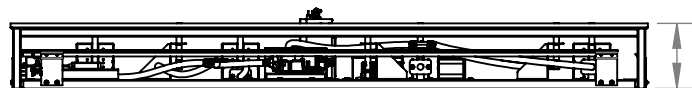

6.10

RIGHT VIEW



GAS OUT



TITLE:

TRADITIONAL
LINEAR DROP IN BURNER
LDBT72-EN, LDBT72-EP

SIZE

DWG. NO.

REV

A

LDBT-72-XX

A

SCALE: N/A WEIGHT:

SHEET 1 OF 1

2

1