

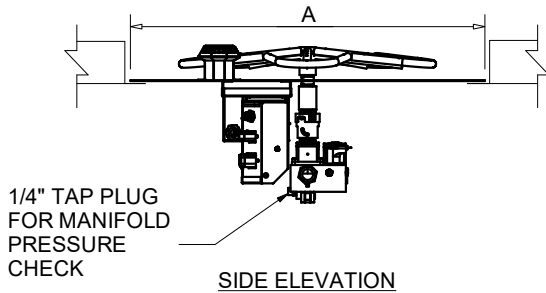

FIRE INSPIRED[™]

**CSA CERTIFIED-OUTDOOR USE ONLY
FOR COMMERCIAL AND RESIDENTIAL USE**

**HEARTH PRODUCTS CONTROLS
2225 LYONS RD.
MIAMISBURG, OH 45342
TOLL FREE: 877.585.9800
PHONE: 937.436.9800
www.hpcfire.com**



EXAMPLE:
TOR-PENTA24EI

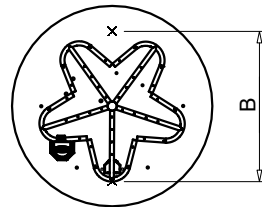
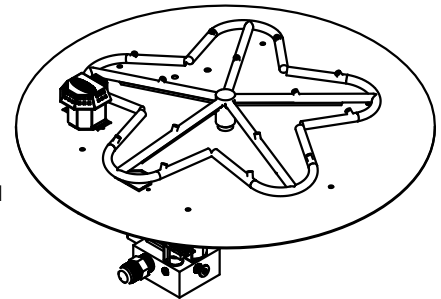

AVAILABLE IN:

- 120VAC OR 24VAC
- ON/OFF OR HI/LO

MATERIAL: 304 STAINLESS STEEL

HI/LO MODELS HAVE A 40% REDUCTION IN BTU ON LOW SETTING

PENTA BURNER							
PART NUMBER*		BTU		DIMENSION CHART			
		PENTA	TORPEDO	A"	B"	C" (+/- 1/2")	
						PENTA	TORPEDO
TOR-	PENTA18EI	65K	90k	18	12	7-3/4	7-3/4
TOR-	PENTA24EI	125K	140k	24	18	9-3/4	7-3/4
TOR-	PENTA30EI	200K	225k	30	24	9-3/4	7-3/4
TOR-	PENTA36EI	250K	275k	36	30	10-3/4	7-3/4
TOR-	PENTA42EI	400K	375K	42	36	11-3/4	7-3/4
TOR-	PENTA54EI	400K	400K	54	48	11-3/4	7-3/4

*FOR TORPEDO BURNERS ADD TOR-

ROUND BURNER				
PART NUMBER	BTU	DIMENSION CHART		
		A"	B"	C" (+/- 1/2")
14SSEI	90K	14	12	7-3/4

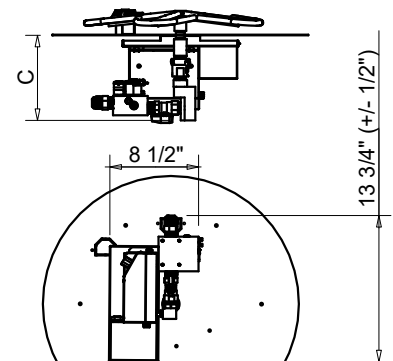
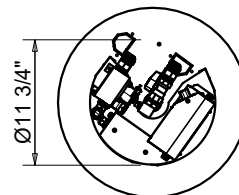
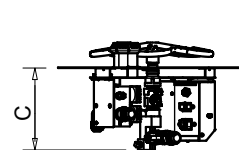

NOTES:

1. PROPER VENTING

• ENCLOSURES:

- For Fire Pit Inserts upto 200K BTU: Required 2 vents, 18 sq.in. each on opposing sides.
- For Fire Pit Inserts 200K to 400K BTU: Required 4 vents, 18 sq.in. each on opposing sides.

- BOWLS (Copper, concrete or metal) - Bowl to be raised above mounting surface minimum of 3/4" gap; Bowl to have a minimum of 6" diameter hole in bottom

2. GAS SUPPLY - FOR USE WITH FIXED PIPING SYSTEMS ONLY - NOT FOR USE WITH SMALL TANKS.

- Natural Gas: Required Supply Pressure: 7.0" W.C.
- LP Gas: Required Supply Pressure: 11.0" W.C.

IMPORTANT: Ensure any flex line that may be used from the permanent main fuel supply to the product is rated to the stated max btu of the product and certified to ANSI Z21.75*CSA 6.27.

3. MODIFICATION OF PRODUCT WILL VOID ANY CERTIFICATION AND WARRANTY.

4. FOLLOW ALL MANUFACTURER'S INSTALLATION INSTRUCTIONS AND LOCAL CODES.

5. ALL DIMENSIONS ARE CONSIDERED TRUE AND REFLECT MANUFACTURER'S SPECIFICATIONS AS OF THE REVISION DATE.

6. DO NOT SCALE DRAWING.

7. THESE DRAWINGS ARE FOR SIZING AND PLANNING PURPOSES. ALL INFORMATION CONTAINED HEREIN WAS CURRENT AT THE TIME OF DEVELOPMENT. THE MANUFACTURER IS RESPONSIBLE FOR THE ACCURACY OF THE DRAWING.

8. CONTRACTOR'S NOTE: FOR PRODUCT AND COMPANY INFORMATION VISIT www.CADdetails.com/info REFERENCE NUMBER 771-046

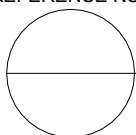

ELECTRONIC IGNITION

EI ROUND FLAT PAN

FLAME SENSING WITH ELECTRONIC HOT SURFACE IGNITION

