



FIRE INSPIRED<sup>®</sup>

Inspired by safety.  
Innovated for your lifestyle.



AR App



Info Inside

# OUTDOOR PRODUCTS DEALER CATALOG

FIRE • WATER • FIRE AND WATER • OUTDOOR DINING

2021-2022



**BILT.**<sup>®</sup>  
Intelligent Instructions



# GREETINGS AND WELCOME

Welcome to our newest edition of the HPC Outdoor Products Dealer Catalog. We at HPC Fire Inspired™ truly appreciate your business, and we're so grateful for the trust you've placed in us. We believe that customer service is not just a department, rather it's the entire company. Our goal is to make your experience as easy and seamless as possible. We will do this through all facets of our business. You may have notice our new messaging, "Inspired by Safety. Innovated for your lifestyle" Only HPC creates safety and confidence with fire-inspired products that outlast and outperform the competition.

I would like to highlight the following new programs to support our mutually beneficial growth aspirations:

1. CSA certified 400+ appliances certified for top performance
2. Lifetime Warranty on burners
3. CADdetails – 3d models
4. New Products Page - 8
5. New Dealer Portal - Ease and accuracy of ordering
6. New AR App Page - 8
7. BILT -3D interactive instructions
8. SMART App Technology to support the operations of the fire feature
9. SST Torpedo Burner with the biggest flame on the market Page - 8
10. HPC Hybrid Oven with Forno de Pizza Page - 6

On behalf of all the team at HPC, I would like to thank you all for your continued support. Cheers to a successful and prosperous year!



All the Best!

Sean Steimle, Chief Executive Officer

## CONTACT



FIRE INSPIRED®

**2225 Lyons Road**  
**Miamisburg, OH 45342**  
**Phone: 877.433.7001**  
**Fax: 877.433.0704**

Email: [orders@hpcfire.com](mailto:orders@hpcfire.com)

**[www.hpcfire.com](http://www.hpcfire.com)**

Printed April 2021

## COVER PHOTO

Courtesy of Site Group

## WHAT DOES MAP MEAN?

Throughout this Dealer Catalog, you will see the acronym MAP. This stands for Minimum Advertised Price, and it's a policy that HPC Fire Inspired™ applies to nearly all our products. Quite simply, this MAP Policy prevents any trade partner from advertising our products at prices below those specified by HPC Fire Inspired™.

For a full explanation on this, and other HPC Fire Inspired™ policies, follow this link to the Policies & Procedures portion of our website. ([hpcfire.com/contact-us](http://hpcfire.com/contact-us))

**MAP**  
**APPLIES**

## QUALITY QUALITY QUALITY

At HPC Fire Inspired™, we build our products with great care, and we back it up with the strongest warranty in the industry. However, should the rare occurrence require repair or return of an HPC Fire Inspired™ product, we have programs that make this rare but unfortunate occurrence easy and painless for dealers.

**Product Returns:** The first step to solving a problem is a call to our Technical Services Department. That will usually take care of the majority of issues. However, if it doesn't, then a RMA (Return Merchandise Authorization) is issued, allowing the customer to send the product back to HPC Fire Inspired™.

**Product Testing:** Every product that is returned to HPC Fire Inspired™ is tested to see what is wrong with it. This testing determines whether the product can be repaired and sent back to the customer, or replaced.

**Warranty:** HPC Fire Inspired™ backs up its products with a strong warranty policy, covering many of our products for up to five years. See chart below.

## WARRANTY POLICY

Components	Application	
Outdoor Fire Components	Residential	Commercial
Fire Pit Stainless Steel Burners	<i>Lifetime</i>	<i>Lifetime</i>
Outdoor Fireplace Burner & Pan	<i>Lifetime</i>	<i>Lifetime</i>
Electronic Components and Gas Valves	3 years	1 year
Pilot Assembly	2 years	1 year
Stainless Steel Components	5 year	1 year
Cold Rolled Steel Components	1 year	6 months
Flex Lines	5 years	1 year
Regulators	3 years	1 year
Outdoor Logs	3 years	3 years
Unfinished Fire Pit Enclosure	5 years	5 years
Copper Bowl Series ( <i>Normal Weathering Expected</i> )	3 years	3 years
Aluminum Fire Pit Covers	3 years	3 years
Vinyl Fire Pit Covers	3 years	3 years
<b>Evolution360™ &amp; H2Onfire Series</b>		
Polyethylene Basin and Liner	3 years	3 year
Water Pump	2 years	1 year
Float and Sensor	2 years	1 year
Hose and Fittings	2 years	2 years
Electronics and LEDs	2 years	1 year

Inspired by safety. Innovated for your lifestyle.

## INTRO

- 2 Greetings
- 3 Table of Contents
- 4 Dealer Incentive Program
- 5 Custom Fire Pits
- 6 **Forno de Pizza**
- 8 New Products

## FIRE PIT INSERTS

- 9 Fire Pits 101
- 11 **Fire Pit Matrix**
- 12 Round Fire Pit Bowl
- 14 Round Flat Fire Pit Pan
- 16 Square Fire Pit Bowl
- 18 Square Flat Fire Pit Pan
- 20 Rectangle H-Burner
- 22 Rectangle S-Fire Burner
- 24 Linear Trough Insert
- 26 Linear Interlink Inserts

## FIREPLACE BURNERS

- 28 Dual Step
- 29 Linear

## RTF PACKAGES

- 30 Round
- 31 Octagon
- 31 Square
- 32 Rectangle Interlink
- 32 Rectangle Trough
- 33 Rectangle H-Fire
- 33 Rectangle S-Fire
- 34 Small Tank Units

## TK TORCH, COPPER, SPORT PIT, FIRE & WATER

- 35 TK Torch
- 36 Mesa
- 37 Sedona
- 37 Tempe
- 38 Sierra
- 38 Phoenix H-Burner
- 39 Phoenix S-Fire
- 39 Phoenix Trough
- 40 Sport Pit
- 41 Evolution 360
- 42 H2Onfire

## ACCESSORIES

- 43 Concrete Fire Logs
- 44 Lava and Ceramic Rock
- 45 Fire Glass
- 46 Wind Guards
- 47 Fire Pit Covers
- 48 Covers/Doors/Vents
- 49 Deck Install/Paver Block
- 51 DIY Enclosure's

## COMPONENTS

- 52 Burner Kits-(FPS)
- 55 Pro Flex Lines
- 55 Flex Lines
- 56 Fire Pit Pans
- 56 Regulators
- 56 Grill Regulators and Hose
- 56 Push Button-(FPK)
- 57 Decorative Key Valves
- 58 Flame Control Systems
- 58 EI Accessories
- 59 Burners-(FRS)
- 62 Log Lighters
- 63 Replacement Components

## POINT OF PURCHASE

- 66 Kiosk Displays
- 66 Literature
- 67 Display Stands
- 67 Point of Purchase Banners

**ACCESSORIES CHART IS ON PAGES 64 AND 65 OF THIS BOOK**

# DEALER INCENTIVE PROGRAM

## **LOCKED-IN INCENTIVE PRICING STRUCTURE FOR AN ENTIRE YEAR:**

When your yearly sales orders meet one of our incentive levels your price structure is locked in for a full calendar year. See dealers incentive schedule in this program. For more information go to [hpcfired.com/dealer](http://hpcfired.com/dealer).

## **PRODUCT DEMOS:**

As a dealer you may request any available product demo for your sales needs.

## **PRODUCT PRESENTATIONS (POWER POINT BASED) – CUSTOMIZED TO YOUR NEEDS:**

As a dealer you may request a customized powerpoint presentation prepared by HPC sales staff for your sales meetings.

## **COMPANY CONTACT INFORMATION LISTED IN OUR DEALER LOCATOR ON OUR WEBSITE:**

As a dealer you will automatically be included in our searchable online referral database at [hpcfired.com/dealer-locator](http://hpcfired.com/dealer-locator)

## **PREFERRED CUSTOMER ADVISORY COUNSEL DISCUSSIONS:**

Each year HPC will put together and request certain dealers participate in an advisory council to voice product needs, value added ideas for the program going forward, and industry news and events.

## **ONLINE ORDER FULFILLMENT:**

HPC offers a searchable online ordering site through the HPC Dealer Portal Store.[hpcfired.com](http://hpcfired.com).

## **NEW PRODUCT DEVELOPMENT INPUT:**

All dealers are encouraged to provide input on new product development.

---

## **HOW WE BEAT MOTHER NATURE**

There's no two ways about it. Outdoor gas fire pits face a double-barrel assault from Nature, namely from wind and rain. But HPC designs its products with Nature in mind, to make sure our fire pits function effectively and safely in the field. For example:

- The Penta Burner sheds rain water in several ways. Each of the five lobes have "weep holes" that drain water. Also, the hub in the center of the burner is sealed to prevent water leaking into the burner.
- HPC's Electronic Ignition models all include a "drip leg" that diverts any water away from the electronics.
- In case of a very strong wind blowing out the fire pit flame, HPC's Electronic Ignition and Push Button/Flame Sense models all are equipped with a thermocouple sensor that will shut off the gas supply if the flame is extinguished. Even without this protection, wind blowing out the flame would be a very rare occurrence, since the pilot flame area is surrounded and protected by a metal "blow-out box."
- Spiders Not Welcome. Strangely, spiders are attracted to the odorant that is added to propane to give it its distinctive smell (alerting people if there is a leak). Their spider nests have the potential of interfering with the flow of gas. However, HPC designs around that by including a mesh "spider guard" on all its CSA-Certified fire pit inserts.



Lastly, we also offer a technologically simple method for protecting against the elements. It's called a cover. All fire pits should be covered when not in use, especially in the off-season.

## **HPC'S VISION STATEMENT**

**To provide innovative and safe solutions that inspire the world to create memorable moments and real conversations.**

## CUSTOM FIRE PITS

One would think that with over 300 standard off-the-shelf fire pit inserts there would be no need for custom designs...think again! Our creative and always "thinking out of the box" network of Dealers never stop- often thanks to you the End User!

Our team of designers is certified by the National Fireplace Institute (NFI) to ensure product safety and proper operation. HPC designs and manufactures commercial or residential fire features including custom enclosures and fire pit inserts of any shape or size- from 2 feet to 30 feet wide, from 25 thousand to 600 thousand Btu output. These fire products can be found at large venues throughout the world including casinos, resorts, ball parks, airports, malls, restaurants....and your backyard!

The custom flame control technology HPC offers ranges from the small match lit to the simple flame sensing controls to the very popular Electronic Ignition controls allowing for remote start and automatic relight. Our custom manufactured burner / pan assemblies are made of high-grade stainless steel material specifically designed to meet your need- these commonly consist of large manifolds or fire rings in any shape or size.

Please allow us to assist you in the design of your custom project. We will be happy to provide input- our years of experience and knowledge of outdoor and indoor systems will make it easy and more importantly keep it safe.

## CUSTOM FIRE PITS HIGHLIGHTS

- **Design & layout assistance from NFI Certified Technicians**
- **Custom drawings & models**
- **Vast catalog offering of CSA Certified Products may fit your custom needs with small or no modification to the product**

**Design burner, pan, and/or control systems to fit your needs**



Go to [hpcfire.com/custom](http://hpcfire.com/custom) to complete the custom fire pit form

# FORNO DE PIZZA

## OUTDOOR DINING NEVER TASTED SO GOOD

The design and manufacturing process developed by Forno de Pizza in West Michigan is focused on the highest level of design, quality, and performance. This approach mandates an oven different from any others made today and guarantees a fundamental simplicity of operation and maintenance, making possible a closer relationship between owner and oven.

What is it about wood-fired ovens that is so captivating, or what makes the experience of cooking so wonderfully pleasant? We are convinced that ovens, in order to provide the perfect food, must not only be functional, but also beautiful and well-made and perfectly fitted to their purpose. In our lifestyles predictability and performance are simultaneously linked to the pleasant experiences we cherish.



## ACCESSORIES



### INFRARED THERMOMETER

FDP-INFRA-RED GUN



### DOOR WITH THERMOSTAT

FDP-DOOR



### GRILL RACK

FDP-GRILL RACK



### UTENSIL HOLDER

FDP-HOLD HOLDER



### BRUSH

FDP-BRUSH



### PAN PEEL

FDP-ALUM PEEL



### WOODEN PADDLES

FDP-WOOD PADDLE



### PIZZA PLATES

FDP-PANS



### DOUGH SHEETS

FDP-DOUGH ROLLING SHEETS

## VINYL COVERS

FDP-COVER-VILLA

FDP-COVER-FORNO

### Forno Series (Portable)

The FORNO Series is a portable dual fuel oven that can be wheeled around easily. You have the choice of SIX different mosaic glass tile colors for the oven. It weighs around 450lbs. and can be easily taken apart and transported to various locations. Forno de Pizza's FORNO E.I. series; the classic design inspired the brand with the black cart and intricate hand-crafted glass mosaic oven. This oven has an electronic ignition system that will facilitate oven starts and save on fuel when burner is not in use.

**Includes Glass Tiled Oven, Stainless Steel Hearth, Vent, Powder Coat Black Steel Cart**



### Forno Specifications

Tile Color	Gas type	Model
Ocean Blue	Natural Gas	FDP-FORNO/OB-EI-NG
Ocean Blue	Liquid Propane	FDP-FORNO/OB-EI-LP
Pool Blue	Natural Gas	FDP-FORNO/PB-EI-NG
Pool Blue	Liquid Propane	FDP-FORNO/PB-EI-LP
Simply Red	Natural Gas	FDP-FORNO/SR-EI-NG
Simply Red	Liquid Propane	FDP-FORNO/SR-EI-LP
Black Onyx	Natural Gas	FDP-FORNO/BLX-EI-NG
Black Onyx	Liquid Propane	FDP-FORNO/BLX-EI-LP
Retro	Natural Gas	FDP-FORNO/RETRO-EI-NG
Retro	Liquid Propane	FDP-FORNO/RETRO-EI-LP
Copper	Natural Gas	FDP-FORNO/COPPER-EI-NG
Copper	Liquid Propane	FDP-FORNO/COPPER-EI-LP
Custom Color	Natural Gas	FDP-FORNO/CUSTOM-EI-NG
Custom Color	Liquid Propane	FDP-FORNO/CUSTOM-EI-LP

### Villa Series (Built In)

Hearth and oven installed in a built-in application. Easy installation, 3 easy steps and you can either use LP or natural gas. This oven has to be installed with the custom stainless steel flange. A 35 inch deep counter is necessary for the installation of this model. The lightest dual fuel built-in oven in the market. This oven has an electronic ignition system that will facilitate oven starts and save on fuel when burner not in use.

**Includes Glass Tiled Oven, Stainless Steel Hearth, Vent, Flange Mount**



### Villa Specifications

Tile Color	Gas type	Model
Ocean Blue	Natural Gas	FDP-VILLA/OB-EI-NG
Ocean Blue	Liquid Propane	FDP-VILLA/OB-EI-LP
Pool Blue	Natural Gas	FDP-VILLA/PB-EI-NG
Pool Blue	Liquid Propane	FDP-VILLA/PB-EI-LP
Simply Red	Natural Gas	FDP-VILLA/SR-EI-NG
Simply Red	Liquid Propane	FDP-VILLA/SR-EI-LP
Black Onyx	Natural Gas	FDP-VILLA/BLX-EI-NG
Black Onyx	Liquid Propane	FDP-VILLA/BLX-EI-LP
Retro	Natural Gas	FDP-VILLA/RETRO-EI-NG
Retro	Liquid Propane	FDP-VILLA/RETRO-EI-LP
Copper	Natural Gas	FDP-VILLA/COPPER-EI-NG
Copper	Liquid Propane	FDP-VILLA/COPPER-EI-LP
Custom Color	Natural Gas	FDP-VILLA/CUSTOM-EI-NG
Custom Color	Liquid Propane	FDP-VILLA/CUSTOM-EI-LP

### Di Napoli Series (Do It Yourself - DIY)

The Di Napoli E.I. Series is a built-in enclosed dual fuel with electronic ignition oven that can be installed in a permanent structure with the use of a chimney. Design your own outer shell and take advantage of Forno de Pizza's oven and electronic ignition for easy start ups and continuous controlled oven operation. This oven comes assembled with the hearth, oven, enclosure and a chimney stack, arched front ready to be installed.



**Includes Glass Tiled Oven, Stainless Steel Hearth, Ready To Finish Enclosure**

### Di Napoli

Gas type	Model
Natural Gas	FDP-DiNapoli/RTF-EI-NG
Liquid Propane	FDP-DiNapoli/RTF-EI-LP

### Color Choices



OCEAN BLUE



POOL BLUE



BLACK ONYX



COPPER



RETRO



SIMPLY RED



# HPC'S ANNOUNCEMENTS

## SST TORPEDO™ BURNERS

The commercial-grade SST Torpedo™ burner, available in Penta, Linear and H configurations, is our newly designed nozzle which creates the biggest flame and is targeting those customers seeking an esthetic and experience more like a bonfire. The goal is to give customers yet another option that is inspired by safety, innovated for their lifestyle. This is a great addition to our product offerings, providing customers with an array of flame options.

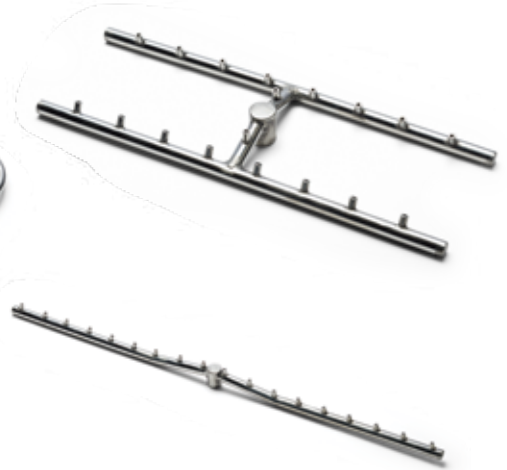

### HOW TO READ THE SKUS IN THIS BOOK

SST Torpedo Burner Callout  
(Remove if you want the standard burners)

120 Volts Alternating Current  
(This area specifies voltage the unit needs)

TOR-PENTA19EI-NG/120VAC

19" Stainless Steel Pan, Electronic Ignition  
(This area specifies pan size, material, and Ignition style)

Natural Gas  
(This area specifies the gas used for the unit)

TOR-PENTA18FPPK-FLEX-NG

SST TORPEDO BURNER (WITH NOZZLES)

PENTA18FPPK-FLEX-NG

STANDARD BURNER (WITHOUT NOZZLES)



## NEW PRODUCTS

WITH CONTINUED INNOVATION COMES  
REGULAR CHANGE!

At HPC Fire Inspired™ we are working on new products daily! We will keep you updated via e-mail blasts, social media and a web page that will have all new products as they are released. Sign up for the newsletter at [HPCfire.com/contact](http://HPCfire.com/contact).



## HPC FIRE AR APP

SELECT, SCAN AND SEE OUR DESIGNS IN YOUR SPACE

HPC Fire Inspired new augmented reality app lets you select options, scan your area, and place our products in your design so you or your client can see in real-time how the fire feature will look in your design in real-time. Just select, scan & see the design in real time.

Download it today on your Apple, Droid, or Google phone today by searching "HPC Fire AR". Or go to [hpcfire.com/hpc-fire-ar](http://hpcfire.com/hpc-fire-ar) Today





## ① MATCH LIT (MLFPK SERIES)

This is our simplest certified fire pit insert- easy to operate and requires the least amount of maintenance.

### How It Works

**Start Up:** This is done by lighting long-stem lighter next to perimeter of burner then slowly open key to valve. Leave key in valve during use.

**Operation:** Flame height may be adjusted by turning key to valve- counterclockwise provides more flame, clockwise lowers flame.

**Shut Down:** To turn OFF the fire pit simply turn key to valve clockwise to OFF position. Remove key.

### Features

- Fully Assembled and ready to install.
- Flex Line configuration provides versatile and simple installation.
- Valve mounting bracket included- for safe mounting of control have.



- Flame height is adjustable using key valve.
- Natural Gas or Liquid Propane: Factory built & tested for either fuel.
- CSA Certified in US & Canada to ANSI Z21.97-2017 / CSA 2.41-2014 requirements.
- Optional Install & Controls: Paver Block Bracket, Key Extension Kit, Long Keys and Spark Ignition Kit.

## ② PUSH BUTTON / FLAME SENSE CONTROL (FPPK SERIES)

This is our mid-range fire pit insert utilizing safety pilot flame control- simply push ignition button and valve control knob to start... flame adjustment is done with knob. This battery operated system is a good solution for flame sensing necessity without AC power requirements.

### How It Works

**Start Up:** This is done by simultaneously pressing valve control knob to start flow of pilot gas and pressing ignition button for spark. Release spark after pilot ignition, release valve control knob after ~20 seconds. Then turn valve control knob counterclockwise to light main burner.

**Operation:** Flame height may be adjusted by turning valve control knob- counterclockwise provides more flame, clockwise lowers flame. If flame loss does occur, the system will automatically turn off all gas flow.

**Shut Down:** To turn OFF the fire pit simply turn valve control knob clockwise- slightly depress knob to reach OFF position.

### Features

- Fully Assembled and ready to install. Control components are protected within valve box.
- Flex Line configuration provides versatile and simple installation.
- Start ignition with push button and valve control knob.
- Flame sensing- system will turn off gas if flame is lost.
- Flame height is adjustable using valve control knob.
- Battery Operated System- is perfect solution for installs with no power.
- Natural Gas or Liquid Propane: Factory built & tested for either fuel.
- CSA Certified in US & Canada to ANSI Z21.97-2017 / CSA 2.41-2014 requirements.

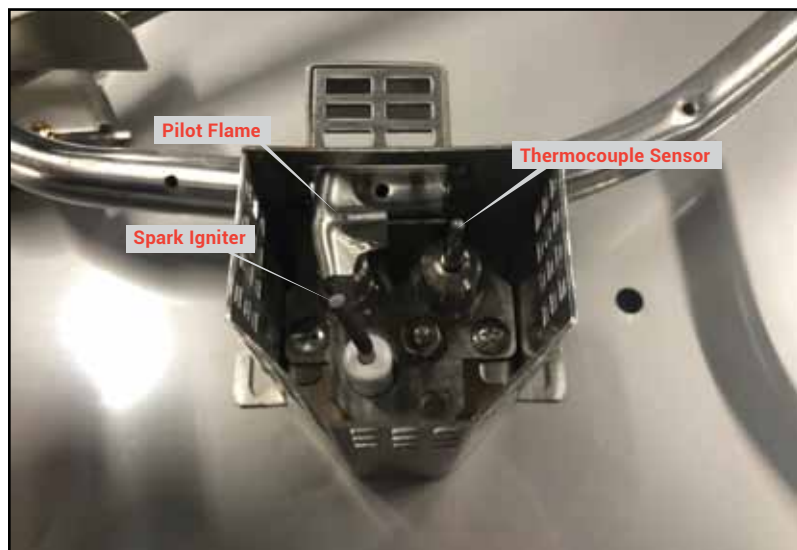

## ③ REMOTE ELECTRONIC IGNITION CONTROL (EI SERIES)

This is our top-of-the-line system featuring the ignition ease with use of a wall switch or handheld remote to control flame as well as auto-re-light if flame loss. This system has numerous convenience and performance improvements for both On/Off Models and our High/Low Models- such as High/Low flame control via our new remote, a redesigned hot surface igniter and many other improvements.

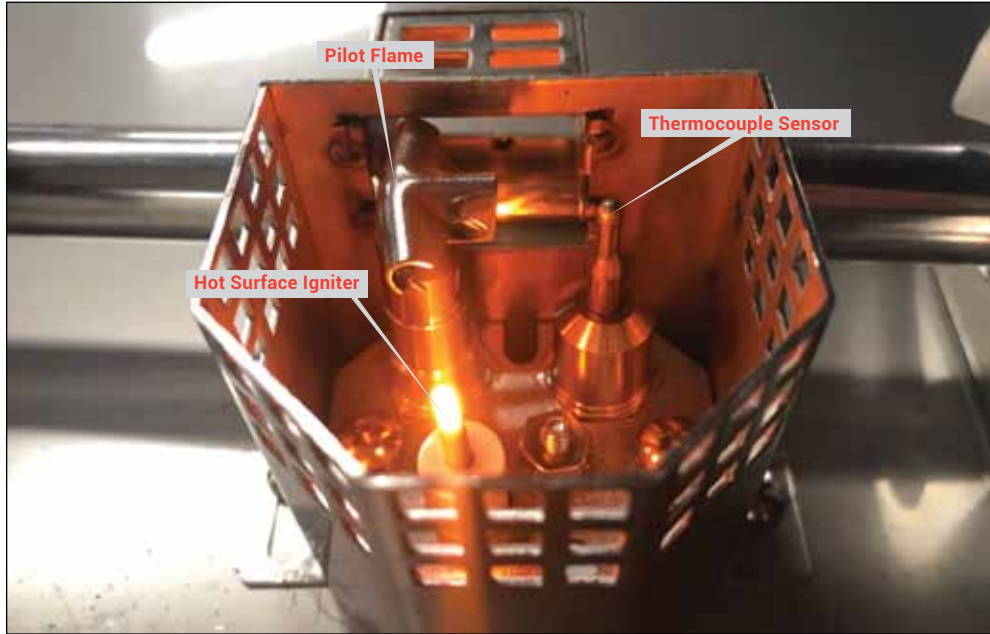

Smart device App available on Hi/Lo Models only

### How It Works

**Start Up:** This is done by use of a wall switch or remote control. When the ON command is received, the system completes initial safety checks then starts flow of pilot gas. After 5 seconds the hot surface igniter glows igniting pilot flame. When the system confirms pilot flame present, the main burner gas will flow ignited by the pilot flame.

**Operation:** While enjoying the ambiance of your fire pit, the system is at work monitoring flame status, internal temperatures / voltages and other safety parameters. If flame loss does occur, the system will turn off all gas flow, and then restart by automatically commencing Start sequence.

**On/Off Models:** Includes the convenience and safety features- optional remote control available.

**Bluetooth High / Low Flame Control Models:** This option includes a smart remote and App via smart device control with 2-way communication with the fire pit. Remote allows flame height control while receiving information from fire pit to advise user of fire pit status (flashing LED).

**Shut Down:** To turn OFF the fire pit simply use wall switch, remote control or whole house system.

### Features

- Fully Assembled- ready to install. Control components are protected within valve box.
- Start via wall switch or remote control; Auto re-light if flame is lost.
- Ignition is complete using a robust and reliable Hot Surface igniter.
- On/Off models: Use with optional wall switch, Remote Control or your whole house system
- High/Low Flame Control Models: Adjust high setting to low setting- ~45% turndown (Remote Control included). Not for use with your whole house system.
- 120vac: Standard outdoor grounded power cord- simply plug into GFCI outlet.
- 24vac Option: Typically used with lower voltage requirements.
- Natural Gas or Liquid Propane: Factory built & tested for either fuel.
- Internal temperature monitoring with overheat auto shutoff.
- CSA Certified in US & Canada to ANSI Z21.97-2017 / CSA 2.41-2014 requirements. (This new EI system already meets upcoming 2020 ANSI requirements).
- Optional Controls: On/Off Remote, Timers, Power Supplies and an Emergency Shutoff. (Pg. 58)

On/Off Model- Remote (Optional)



High / Low Model- Remote (Standard)



Thermocouple Lead crimped by design for ease of install.

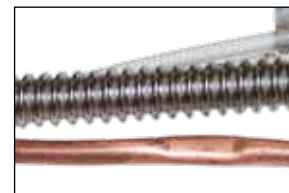

## ELECTRONIC IGNITION FIRE PITS (EI)

		Round		Square		Rectangle H	Rectangle S	Linear	
STYLES									
	<b>Bowl</b>	<b>Flat</b>	<b>Bowl</b>	<b>Flat</b>	<b>Bowl</b>	<b>Bowl</b>	<b>Trough</b>	<b>Interlink</b>	
SIZES	13"	14"	18"	18"	24" x 12"	36" x 14"	24"	25" x 8"	
	19"	18"	24"	24"	30" x 12"	42" x 14"	36"	37" x 8"	
	25"	24"	30"	30"	36" x 14"	54" x 16"	48"	49" x 8"	
	31"	30"	36"	36"	42" x 14"	66" x 16"	60"	61" x 8"	
	37"	36"	42"	42"	54" x 16"	78" x 16"	72"	73" x 8"	
	43"	42"			66" x 16"		96"	97" x 8"	
	54"			78" x 16"			121" x 8"		
				90" x 16"					

All Models Available in Natural Gas or Propane	All Models Available in 120VAC or 24VAC	All Models Available with remote	Remote or App HI/LO or ON/OFF	<b>ON/OFF ONLY</b> (Remote optional)
--	---	----------------------------------	-------------------------------	---

## PUSH BUTTON/FLAME SENSE FIRE PITS (FPPK)

		Round		Square		Rectangle H	Rectangle S	Linear	
STYLES									
	<b>Bowl</b>	<b>Flat</b>	<b>Bowl</b>	<b>Flat</b>	<b>Bowl</b>	<b>Bowl</b>	<b>Trough</b>	<b>Interlink</b>	
SIZES	13"	14"	18"	18"	24" x 12"	36" x 14"	24"	25" x 8"	
	19"	18"	24"	24"	30" x 12"	42" x 14"	36"	37" x 8"	
	25"	24"	30"	30"	36" x 14"	54" x 16"	48"	49" x 8"	
	31"	30"	36"	36"	42" x 14"		60"	61" x 8"	
	37"	36"			54" x 16"		72"	73" x 8"	
						96"	97" x 8"		

All Models Available in Natural Gas or Propane	Battery	Manual Flame Control
--	---------	----------------------

## MATCH LIT FIRE PITS (MLFPK)

		Round		Square		Rectangle H	Rectangle S	Linear	
STYLES									
	<b>Bowl</b>	<b>Flat</b>	<b>Bowl</b>	<b>Flat</b>	<b>Bowl</b>	<b>Bowl</b>	<b>Trough</b>	<b>Interlink</b>	
SIZES	13"	8"	18"	18"	24" x 12"	36" x 14"	24"	25" x 8"	
	19"	14"	24"	24"	30" x 12"		36"	37" x 8"	
	25"	18"	30"	30"	36" x 14"		48"	49" x 8"	
	31"	24"							
	30"								

All Models Available in Natural Gas or Propane	Optional Manual Spark Ignition Kit	Manual Flame Control
--	------------------------------------	----------------------

# ROUND BOWL INSERTS

## EI Series



**24VAC MODELS  
REQUIRE HPC/  
SEBCO 24vac, 100W  
Power Supply for  
inserts ONLY pg. 58**

### Benefits of Round Bowl Inserts:

Sidewall helps with media retention; Pan Lip provides for recessed burner / blowout box.

### Features:

Made of #304, 18 gauge Stainless Steel  
Spun design adds rigidity  
Welded gas fitting for strength  
Weep holes for drainage  
\*Lifetime Warranty on burners



\*See page 8 for details

## MLFPK Series



## FPPK Series



## ACCESSORIES



**EI Accessories (Pg. 58):**  
Timers, Power Supplies, E-Stop

**MLFPK Paver  
Bracket - Pg. 49**

**Wind Guards:  
Pg. 46**

**Covers:  
Pg. 47**

**Media:  
Pg. 45**

12 **WARNING: California PROP 65:** This product can expose you to Lead & Chromium, which is known to the State of California to cause cancer and birth defects or other reproductive harm. For more information go to [www.P65Warnings.ca.gov](http://www.P65Warnings.ca.gov).

Inspired by safety. Innovated for your lifestyle.



See Pg. 10 for EI System Features



**Electronic Ignition Models - EI Series Specifications**

Size (A")	Power	Gas type	Nozzle	Std Model - Flame ON/OFF	Nozzle	Std Model - Bluetooth (HI/LO)	Burner	Max BTU	Nozzle BTU
13"	120vac	Natural Gas Liquid Propane		13SSEI-NG/120VAC 13SSEI-LP/120VAC		13SSEI-HI/LO-NG/120VAC 13SSEI-HI/LO-LP/120VAC	12" Round	90k	
	* 24vac	Natural Gas Liquid Propane		13SSEI-NG/24VAC 13SSEI-LP/24VAC		13SSEI-HI/LO-NG/24VAC 13SSEI-HI/LO-LP/24VAC			
19"	120vac	Natural Gas Liquid Propane	TOR- TOR-	PENTA19EI-NG/120VAC PENTA19EI-LP/120VAC	TOR- TOR-	PENTA19EI-HI/LO-NG/120VAC PENTA19EI-HI/LO-LP/120VAC	12" Penta	65k	65k
	* 24vac	Natural Gas Liquid Propane	TOR- TOR-	PENTA19EI-NG/24VAC PENTA19EI-LP/24VAC	TOR- TOR-	PENTA19EI-HI/LO-NG/24VAC PENTA19EI-HI/LO-LP/24VAC			
25"	120vac	Natural Gas Liquid Propane	TOR- TOR-	PENTA25EI-NG/120VAC PENTA25EI-LP/120VAC	TOR- TOR-	PENTA25EI-HI/LO-NG/120VAC PENTA25EI-HI/LO-LP/120VAC	18" Penta	125k	125k
	* 24vac	Natural Gas Liquid Propane	TOR- TOR-	PENTA25EI-NG/24VAC PENTA25EI-LP/24VAC	TOR- TOR-	PENTA25EI-HI/LO-NG/24VAC PENTA25EI-HI/LO-LP/24VAC			
31"	120vac	Natural Gas Liquid Propane	TOR- TOR-	PENTA31EI-NG/120VAC PENTA31EI-LP/120VAC	TOR- TOR-	PENTA31EI-HI/LO-NG/120VAC PENTA31EI-HI/LO-LP/120VAC	24" Penta	200k	200k
	* 24vac	Natural Gas Liquid Propane	TOR- TOR-	PENTA31EI-NG/24VAC PENTA31EI-LP/24VAC	TOR- TOR-	PENTA31EI-HI/LO-NG/24VAC PENTA31EI-HI/LO-LP/24VAC			
37"	120vac	Natural Gas Liquid Propane	TOR- TOR-	PENTA37EI-NG/120VAC PENTA37EI-LP/120VAC	TOR- TOR-	PENTA37EI-HI/LO-NG/120VAC PENTA37EI-HI/LO-LP/120VAC	30" Penta	250k	275k
	* 24vac	Natural Gas Liquid Propane	TOR- TOR-	PENTA37EI-NG/24VAC PENTA37EI-LP/24VAC	TOR- TOR-	PENTA37EI-HI/LO-NG/24VAC PENTA37EI-HI/LO-LP/24VAC			
43"	120vac	Natural Gas Liquid Propane	TOR- TOR-	PENTA43EI-NG/120VAC PENTA43EI-LP/120VAC			36" Penta	400k	375k
	* 24vac	Natural Gas Liquid Propane	TOR- TOR-	PENTA43EI-NG/24VAC PENTA43EI-LP/24VAC					

**EI MODELS INCLUDE:** Insert: Fully Assembled. Flex Line: Gas Input and Instructions **\*IMPORTANT: 24vac Models REQUIRE HPC/ SEBCO 24vac, 100W Power Supply pg. 58**  
**SOLD SEPARATELY (EI INSERT):** On/Off Models 120VAC- Remote: 578-C: See Pg. 58.

See Pg. 9 for FPPK System Features



**Push Button/Flame Sense Models - FPPK Flex Series Specifications**

Size (A")	Gas type	Nozzle	Std Model	Nozzle	Std Remote Small Tank Model	Burner	Max BTU	Nozzle BTU
13"	Natural Gas Liquid Propane		FPPK13-FLEX-NG FPPK13-FLEX-LP		FPPK13-FLEX-LP-ST	12" Round	90k	
	Natural Gas Liquid Propane	TOR- TOR-	PENTA19FPPK-FLEX-NG PENTA19FPPK-FLEX-LP	TOR-	PENTA19FPPK-FLEX-LP-ST*	12" Penta	65k	65k
25"	Natural Gas Liquid Propane	TOR- TOR-	PENTA25FPPK-FLEX-NG PENTA25FPPK-FLEX-LP	TOR-	PENTA25FPPK-FLEX-LP-ST*	18" Penta	90k	125k
	Natural Gas Liquid Propane	TOR- TOR-	PENTA31FPPK-FLEX-NG PENTA31FPPK-FLEX-LP			24" Penta	140k	150k
37"	Natural Gas Liquid Propane	TOR- TOR-	PENTA37FPPK-FLEX-NG PENTA37FPPK-FLEX-LP			30" Penta	140k	175k

See Pg. 9 for MLFPK System Features



**Match Lit Models - MLFPK Flex Series Specifications**

Size (A")	Gas type	Nozzle	Std Model	Nozzle	Std Remote Small Tank Model	Burner	Max BTU	Nozzle BTU
13"	Natural Gas Liquid Propane	TOR- TOR-	PENTA13 MLFPK-FLEX-NG PENTA13 MLFPK-FLEX-LP	TOR-	PENTA13 MLFPK-FLEX-LP-ST*	12" Penta	65k	65k
	Natural Gas Liquid Propane	TOR- TOR-	PENTA19 MLFPK-FLEX-NG PENTA19 MLFPK-FLEX-LP	TOR-	PENTA19 MLFPK-FLEX-LP-ST*	12" Penta	65k	65k
25"	Natural Gas Liquid Propane	TOR- TOR-	PENTA25 MLFPK-FLEX-NG PENTA25 MLFPK-FLEX-LP	TOR-	PENTA25 MLFPK-FLEX-LP-ST*	18" Penta	65k	65k
	Natural Gas Liquid Propane	TOR- TOR-	PENTA31 MLFPK-FLEX-NG PENTA31 MLFPK-FLEX-LP	TOR-	PENTA31 MLFPK-FLEX-LP-ST*	18" Penta	65k	65k

**FPPK & MLFPK MODELS INCLUDE:** Insert: Fully Assembled and Instructions  
**SOLD SEPARATELY: (FPPK-MLFPK) Input Flex Line: SSC24: All models**

**\*IMPORTANT: On Small Tank Units** The BTU's are the same as the non Nozzle units

TOP SELLING SIZES

Need help? Use our fire pit selector at [hpcfire.com](http://hpcfire.com)

Match proper accessories to your fire pit model - see Pg. 64 - 65.

# ROUND FLAT INSERTS

## EI Series

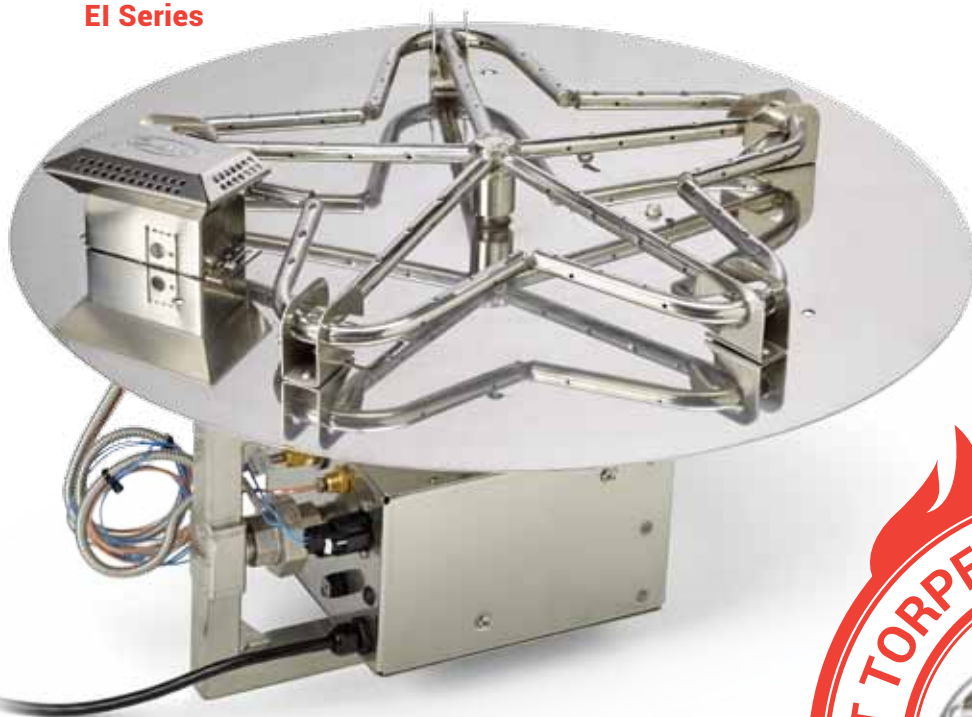

**24VAC MODELS REQUIRE HPC/ SEBCO 24vac, 100W Power Supply for inserts ONLY pg. 58**

### Benefits of Round Flat Inserts:

Economical flat design- used in enclosures that have recess mount and internal sidewalls for media.

### Features:

- Made of #304, 18 gauge Stainless Steel
- Raised hub burner for water prevention
- Welded gas fitting for strength
- Weep holes for drainage
- \*Lifetime Warranty on burners



\*See page 8 for details

## MLFPK Series



## FPPK Series



## ACCESSORIES



**EI Accessories (Pg. 58):**  
Timers, Power Supplies, E-Stop

**MLFPK Paver Bracket - Pg. 49**

**Wind Guards: Pg. 46**

**Covers: Pg. 47**

**Media: Pg. 45**

**\*IMPORTANT: On Small Tank Units** The BTU's are the same as the non Nozzle units



See Pg. 10 for EI System Features



**Electronic Ignition Models - EI Series Specifications**

Size	Power	Gas type	Nozzle	Std Model- Flame ON/OFF	Nozzle	Std Model - Bluetooth (HI/LO)	Burner	Max BTU	Nozzle BTU
14"	120vac	Natural Gas Liquid Propane		14FSSEI-NG/120VAC 14FSSEI-LP/120VAC		14FSSEI-HI/LO-NG/120VAC 14FSSEI-HI/LO-LP/120VAC	12" Round	90k	
	* 24vac	Natural Gas Liquid Propane		14FSSEI-NG/24VAC 14FSSEI-LP/24VAC		14FSSEI-HI/LO-NG/24VAC 14FSSEI-HI/LO-LP/24VAC			
18"	120vac	Natural Gas Liquid Propane	TOR- TOR-	PENTA18EI-NG/120VAC PENTA18EI-LP/120VAC	TOR- TOR-	PENTA18EI-HI/LO-NG/120VAC PENTA18EI-HI/LO-LP/120VAC	12" Penta	65k	65k
	* 24vac	Natural Gas Liquid Propane	TOR- TOR-	PENTA18EI-NG/24VAC PENTA18EI-LP/24VAC	TOR- TOR-	PENTA18EI-HI/LO-NG/24VAC PENTA18EI-HI/LO-LP/24VAC			
24"	120vac	Natural Gas Liquid Propane	TOR- TOR-	PENTA24EI-NG/120VAC PENTA24EI-LP/120VAC	TOR- TOR-	PENTA24EI-HI/LO-NG/120VAC PENTA24EI-HI/LO-LP/120VAC	18" Penta	125k	125k
	* 24vac	Natural Gas Liquid Propane	TOR- TOR-	PENTA24EI-NG/24VAC PENTA24EI-LP/24VAC	TOR- TOR-	PENTA24EI-HI/LO-NG/24VAC PENTA24EI-HI/LO-LP/24VAC			
30"	120vac	Natural Gas Liquid Propane	TOR- TOR-	PENTA30EI-NG/120VAC PENTA30EI-LP/120VAC	TOR- TOR-	PENTA30EI-HI/LO-NG/120VAC PENTA30EI-HI/LO-LP/120VAC	24" Penta	200k	200k
	* 24vac	Natural Gas Liquid Propane	TOR- TOR-	PENTA30EI-NG/24VAC PENTA30EI-LP/24VAC	TOR- TOR-	PENTA30EI-HI/LO-NG/24VAC PENTA30EI-HI/LO-LP/24VAC			
36"	120vac	Natural Gas Liquid Propane	TOR- TOR-	PENTA36EI-NG/120VAC PENTA36EI-LP/120VAC	TOR- TOR-	PENTA36EI-HI/LO-NG/120VAC PENTA36EI-HI/LO-LP/120VAC	30" Penta	250k	275k
	* 24vac	Natural Gas Liquid Propane	TOR- TOR-	PENTA36EI-NG/24VAC PENTA36EI-LP/24VAC	TOR- TOR-	PENTA36EI-HI/LO-NG/24VAC PENTA36EI-HI/LO-LP/24VAC			
42"	120vac	Natural Gas Liquid Propane	TOR- TOR-	PENTA42EI-NG/120VAC PENTA42EI-LP/120VAC			36" Penta	400k	375k
	* 24vac	Natural Gas Liquid Propane	TOR- TOR-	PENTA42EI-NG/24VAC PENTA42EI-LP/24VAC					
54"	120vac	Natural Gas Liquid Propane	TOR- TOR-	PENTA54EI-NG/120VAC PENTA54EI-LP/120VAC			48" Penta	400k	400k
	* 24vac	Natural Gas Liquid Propane	TOR- TOR-	PENTA54EI-NG/24VAC PENTA54EI-LP/24VAC					

**EI MODELS INCLUDE:** Insert: Fully Assembled. Flex Line: Gas Input and Instructions  
**SOLD SEPARATELY (EI INSERT):** On/Off Models 120VAC- Remote: 578-C. See Pg. 58.

**\*IMPORTANT: 24vac Models REQUIRE HPC/ SEBCO 24vac, 100W Power Supply pg. 58**

**TOP SELLING SIZES**

**Push Button/Flame Sense Models - FPPK Flex Series Specifications**

See Pg. 9 for FPPK System Features



Size	Gas type	Nozzle	Std Model	Nozzle	Std Remote Small Tank Model	Burner	Max BTU	Nozzle BTU
14"	Natural Gas Liquid Propane		FPPK14-FLEX-NG FPPK14-FLEX-LP		FPPK14-FLEX-LP-ST	12" Round	90k	
	Natural Gas Liquid Propane	TOR- TOR-	PENTA18FPPK-FLEX-NG PENTA18FPPK-FLEX-LP	TOR-	PENTA18FPPK-FLEX-LP-ST*	12" Penta	65k	65k
24"	Natural Gas Liquid Propane	TOR- TOR-	PENTA24FPPK-FLEX-NG PENTA24FPPK-FLEX-LP	TOR-	PENTA24FPPK-FLEX-LP-ST*	18" Penta	90k	125k
	Natural Gas Liquid Propane	TOR- TOR-	PENTA30FPPK-FLEX-NG PENTA30FPPK-FLEX-LP			24" Penta	140k	150k
36"	Natural Gas Liquid Propane	TOR- TOR-	PENTA36FPPK-FLEX-NG PENTA36FPPK-FLEX-LP			30" Penta	140k	175k

See Pg. 9 for MLFPK System Features



**Match Lit Models - MLFPK Flex Series Specifications**

Size	Gas type	Nozzle	Std Model	Nozzle	Std Remote Small Tank Model	Burner	Max BTU	Nozzle BTU
8"	Natural Gas Liquid Propane		MLFPK8-FLEX-NG MLFPK8-FLEX-LP		MLFPK8-FLEX-LP-ST	6" Round	40k	
	Natural Gas Liquid Propane	TOR- TOR-	PENTA14 MLFPK-FLEX-NG PENTA14 MLFPK-FLEX-LP	TOR-	PENTA14 MLFPK-FLEX-LP-ST*	12" Penta	65k	65k
18"	Natural Gas Liquid Propane	TOR- TOR-	PENTA18 MLFPK-FLEX-NG PENTA18 MLFPK-FLEX-LP	TOR-	PENTA18 MLFPK-FLEX-LP-ST*	12" Penta	65k	65k
	Natural Gas Liquid Propane	TOR- TOR-	PENTA24 MLFPK-FLEX-NG PENTA24 MLFPK-FLEX-LP	TOR-	PENTA24 MLFPK-FLEX-LP-ST*	18" Penta	65k	65k
30"	Natural Gas Liquid Propane	TOR- TOR-	PENTA30 MLFPK-FLEX-NG PENTA30 MLFPK-FLEX-LP	TOR-	PENTA30 MLFPK-FLEX-LP-ST*	18" Penta	65k	65k

**FPPK & MLFPK MODELS INCLUDE:** Insert: Fully Assembled and Instructions  
**SOLD SEPARATELY: (FPPK-MLFPK) Input Flex Line: SSC24: All models**

**Match proper accessories to your fire pit model - see Pg. 64 - 65.**

Need help? Use our fire pit selector at [hpcfire.com](http://hpcfire.com)

# SQUARE BOWL INSERTS

## EI Series

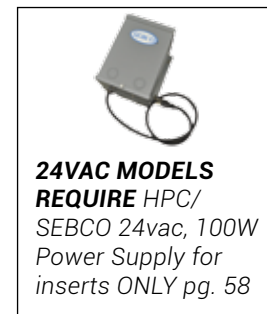

**24VAC MODELS  
REQUIRE HPC/  
SEBCO 24vac, 100W  
Power Supply for  
inserts ONLY pg. 58**

### Benefits of a Square Bowl Insert:

Sidewall helps with media retention; Pan Lip provides for recessed burner / blowout box...

### Features:

Made of #304, 18 gauge Stainless Steel  
Raised hub burner for water prevention  
Welded gas fitting for strength  
Weep holes for drainage  
*\*Lifetime Warranty on burners*



\*See page 8 for details

## MLFPK Series



## FPPK Series



**SIK36 -  
MANUAL SPARK  
IGNITION** for  
match lit fire pits  
pg. 50

## ACCESSORIES



**EI Accessories (Pg. 58):**  
Timers, Power Supplies, E-Stop

**MLFPK Paver  
Bracket - Pg. 49**

**Wind Guards:**  
Pg. 46

**Covers:**  
Pg. 47

**Media:**  
Pg. 45

16 **WARNING: California PROP 65:** This product can expose you to Lead & Chromium, which is known to the State of California to cause cancer and birth defects or other reproductive harm. For more information go to [www.P65Warnings.ca.gov](http://www.P65Warnings.ca.gov).

Inspired by safety. Innovated for your lifestyle.





See Pg. 10 for EI System Features



**Electronic Ignition Models - EI Series Specifications**

Size	Power	Gas type	Nozzle	Std Model - Flame ON/OFF	Nozzle	Std Model - Bluetooth (HI/LO)	Burner	Max BTU	Nozzle BTU
18"	120vac	Natural Gas	TOR-	18SSEI-SQBL-NG/120VAC	TOR-	18SSEI-SQBL-HI/LO-NG/120VAC	12" Penta	65k	65k
		Liquid Propane	TOR-	18SSEI-SQBL-LP/120VAC	TOR-	18SSEI-SQBL-HI/LO-LP/120VAC			
	* 24vac	Natural Gas	TOR-	18SSEI-SQBL-NG/24VAC	TOR-	18SSEI-SQBL-HI/LO-NG/24VAC			
		Liquid Propane	TOR-	18SSEI-SQBL-LP/24VAC	TOR-	18SSEI-SQBL-HI/LO-LP/24VAC			
24"	120vac	Natural Gas	TOR-	24SSEI-SQBL-NG/120VAC	TOR-	24SSEI-SQBL-HI/LO-NG/120VAC	18" Penta	125k	125k
		Liquid Propane	TOR-	24SSEI-SQBL-LP/120VAC	TOR-	24SSEI-SQBL-HI/LO-LP/120VAC			
	* 24vac	Natural Gas	TOR-	24SSEI-SQBL-NG/24VAC	TOR-	24SSEI-SQBL-HI/LO-NG/24VAC			
		Liquid Propane	TOR-	24SSEI-SQBL-LP/24VAC	TOR-	24SSEI-SQBL-HI/LO-LP/24VAC			
30"	120vac	Natural Gas	TOR-	30SSEI-SQBL-NG/120VAC	TOR-	30SSEI-SQBL-HI/LO-NG/120VAC	24" Penta	200k	200k
		Liquid Propane	TOR-	30SSEI-SQBL-LP/120VAC	TOR-	30SSEI-SQBL-HI/LO-LP/120VAC			
	* 24vac	Natural Gas	TOR-	30SSEI-SQBL-NG/24VAC	TOR-	30SSEI-SQBL-HI/LO-NG/24VAC			
		Liquid Propane	TOR-	30SSEI-SQBL-LP/24VAC	TOR-	30SSEI-SQBL-HI/LO-LP/24VAC			
36"	120vac	Natural Gas	TOR-	36SSEI-SQBL-NG/120VAC	TOR-	36SSEI-SQBL-HI/LO-NG/120VAC	30" Penta	250k	275k
		Liquid Propane	TOR-	36SSEI-SQBL-LP/120VAC	TOR-	36SSEI-SQBL-HI/LO-LP/120VAC			
	* 24vac	Natural Gas	TOR-	36SSEI-SQBL-NG/24VAC	TOR-	36SSEI-SQBL-HI/LO-NG/24VAC			
		Liquid Propane	TOR-	36SSEI-SQBL-LP/24VAC	TOR-	36SSEI-SQBL-HI/LO-LP/24VAC			
42"	120vac	Natural Gas	TOR-	42SSEI-SQBL-NG/120VAC			36" Penta	400k	375k
		Liquid Propane	TOR-	42SSEI-SQBL-LP/120VAC					
	* 24vac	Natural Gas	TOR-	42SSEI-SQBL-NG/24VAC					
		Liquid Propane	TOR-	42SSEI-SQBL-LP/24VAC					

**EI MODELS INCLUDE:** Insert: Fully Assembled. Flex Line: Gas Input and Instructions **\*IMPORTANT: 24vac Models REQUIRE HPC/SEBCO 24vac, 100W Power Supply pg. 58**  
**SOLD SEPARATELY (EI INSERT):** On/Off Models 120VAC- Remote: 578-C: See Pg. 58.

See Pg. 9 for FPPK System Features



**Push Button/Flame Sense Models - FPPK Flex Series Specifications**

Size	Gas type	Nozzle	Std Model	Nozzle	Std Remote Small Tank Model	Burner	Max BTU	Nozzle BTU
18"	Natural Gas	TOR-	FPPK18-SQBL-FLEX-NG			12" Penta	65k	65k
	Liquid Propane	TOR-	FPPK18-SQBL-FLEX-LP	TOR-	FPPK18-SQBL-FLEX-LP-ST*			
24"	Natural Gas	TOR-	FPPK24-SQBL-FLEX-NG			18" Penta	90k	125k
	Liquid Propane	TOR-	FPPK24-SQBL-FLEX-LP	TOR-	FPPK24-SQBL-FLEX-LP-ST*			
30"	Natural Gas	TOR-	FPPK30-SQBL-FLEX-NG			24" Penta	140k	150k
	Liquid Propane	TOR-	FPPK30-SQBL-FLEX-LP					
36"	Natural Gas	TOR-	FPPK36-SQBL-FLEX-NG			30" Penta	140k	175k
	Liquid Propane	TOR-	FPPK36-SQBL-FLEX-LP					

See Pg. 9 for MLFPK System Features



**Match Lit Models - MLFPK Flex Series Specifications**

Size	Gas type	Nozzle	Std Model	Nozzle	Std Remote Small Tank Model	Burner	Max BTU	Nozzle BTU
18"	Natural Gas	TOR-	MLFPK18SQBL-FLEX-NG			12" Penta	65k	65k
	Liquid Propane	TOR-	MLFPK18SQBL-FLEX-LP	TOR-	MLFPK18SQBL-FLEX-LP-ST*			
24"	Natural Gas	TOR-	MLFPK24SQBL-FLEX-NG			18" Penta	65k	65k
	Liquid Propane	TOR-	MLFPK24SQBL-FLEX-LP	TOR-	MLFPK24SQBL-FLEX-LP-ST*			
30"	Natural Gas	TOR-	MLFPK30SQBL-FLEX-NG			18" Penta	65k	65k
	Liquid Propane	TOR-	MLFPK30SQBL-FLEX-LP	TOR-	MLFPK30SQBL-FLEX-LP-ST*			

**FPPK & MLFPK MODELS INCLUDE:** Insert: Fully Assembled and Instructions  
**SOLD SEPARATELY: (FPPK-MLFPK) Input Flex Line: SSC24: All models**

**\*IMPORTANT: On Small Tank Units** The BTU's are the same as the non Nozzle units



TOP SELLING SIZES

Need help? Use our fire pit selector at [hpcfire.com](http://hpcfire.com)

Match proper accessories to your fire pit model - see Pg. 64 - 65.

# SQUARE FLAT INSERTS

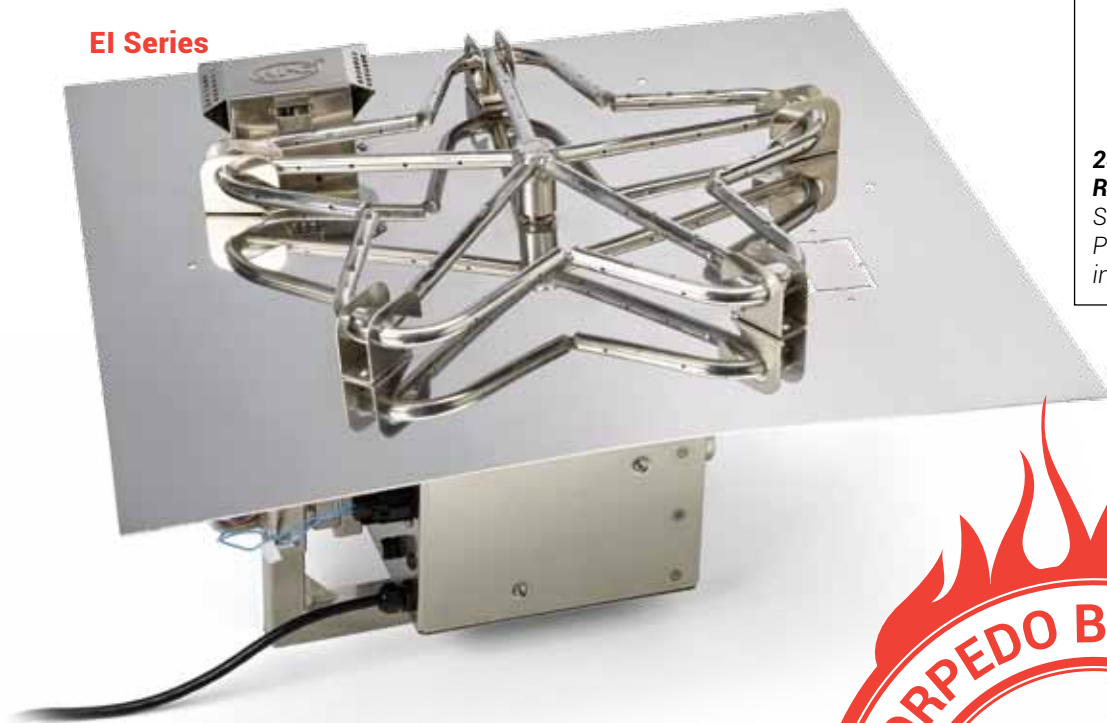
## EI Series

**24VAC MODELS  
REQUIRE HPC/  
SEBCO 24vac, 100W  
Power Supply for  
inserts ONLY pg. 58**

### Benefits of a Square Flat Insert:

Economical flat design- used in enclosures that have recess mount and internal sidewalls for media.

### Features:

- Made of #304, 18 gauge Stainless Steel
- Raised hub burner for water prevention
- Welded gas fitting for strength
- Weep holes for drainage
- \*Lifetime Warranty on burners



\*See page 8 for details



## MLFPK Series



## FPPK Series



# ACCESSORIES



**EI Accessories (Pg. 58):**  
Timers, Power Supplies, E-Stop

**MLFPK Paver  
Bracket - Pg. 49**

**Wind Guards:  
Pg. 46**

**Covers:  
Pg. 47**

**Media:  
Pg. 45**

18 **WARNING: California PROP 65:** This product can expose you to Lead & Chromium, which is known to the State of California to cause cancer and birth defects or other reproductive harm. For more information go to [www.P65Warnings.ca.gov](http://www.P65Warnings.ca.gov).

Inspired by safety. Innovated for your lifestyle.



See Pg. 10 for EI System Features



### Electronic Ignition Models - EI Series Specifications

Size	Power	Gas type	Nozzle	Std Model - Flame ON/OFF	Nozzle	Std Model - Bluetooth (HI/LO)	Burner	Max BTU	Nozzle BTU
18"	120vac	Natural Gas	TOR-	18FSSEI-SQ-NG/120VAC	TOR-	18FSSEI-SQ-HI/LO-NG/120VAC	12" Penta	65k	65k
		Liquid Propane	TOR-	18FSSEI-SQ-LP/120VAC	TOR-	18FSSEI-SQ-HI/LO-LP/120VAC			
24"	* 24vac	Natural Gas	TOR-	18FSSEI-SQ-NG/24VAC	TOR-	18FSSEI-SQ-HI/LO-NG/24VAC	18" Penta	125k	125k
		Liquid Propane	TOR-	18FSSEI-SQ-LP/24VAC	TOR-	18FSSEI-SQ-HI/LO-LP/24VAC			
24"	120vac	Natural Gas	TOR-	24FSSEI-SQ-NG/120VAC	TOR-	24FSSEI-SQ-HI/LO-NG/120VAC	18" Penta	125k	125k
		Liquid Propane	TOR-	24FSSEI-SQ-LP/120VAC	TOR-	24FSSEI-SQ-HI/LO-LP/120VAC			
30"	* 24vac	Natural Gas	TOR-	24FSSEI-SQ-NG/24VAC	TOR-	24FSSEI-SQ-HI/LO-NG/24VAC	24" Penta	200k	200k
		Liquid Propane	TOR-	24FSSEI-SQ-LP/24VAC	TOR-	24FSSEI-SQ-HI/LO-LP/24VAC			
30"	120vac	Natural Gas	TOR-	30FSSEI-SQ-NG/120VAC	TOR-	30FSSEI-SQ-HI/LO-NG/120VAC	24" Penta	200k	200k
		Liquid Propane	TOR-	30FSSEI-SQ-LP/120VAC	TOR-	30FSSEI-SQ-HI/LO-LP/120VAC			
36"	* 24vac	Natural Gas	TOR-	30FSSEI-SQ-NG/24VAC	TOR-	30FSSEI-SQ-HI/LO-NG/24VAC	30" Penta	250k	275k
		Liquid Propane	TOR-	30FSSEI-SQ-LP/24VAC	TOR-	30FSSEI-SQ-HI/LO-LP/24VAC			
36"	120vac	Natural Gas	TOR-	36FSSEI-SQ-NG/120VAC	TOR-	36FSSEI-SQ-HI/LO-NG/120VAC	30" Penta	250k	275k
		Liquid Propane	TOR-	36FSSEI-SQ-LP/120VAC	TOR-	36FSSEI-SQ-HI/LO-LP/120VAC			
42"	* 24vac	Natural Gas	TOR-	36FSSEI-SQ-NG/24VAC	TOR-	36FSSEI-SQ-HI/LO-NG/24VAC	36" Penta	400k	375k
		Liquid Propane	TOR-	36FSSEI-SQ-LP/24VAC	TOR-	36FSSEI-SQ-HI/LO-LP/24VAC			
42"	120vac	Natural Gas	TOR-	42FSSEI-SQ-NG/120VAC			36" Penta	400k	375k
		Liquid Propane	TOR-	42FSSEI-SQ-LP/120VAC					
42"	* 24vac	Natural Gas	TOR-	42FSSEI-SQ-NG/24VAC			36" Penta	400k	375k
		Liquid Propane	TOR-	42FSSEI-SQ-LP/24VAC					

**EI MODELS INCLUDE:** Insert: Fully Assembled. Flex Line: Gas Input and Instructions **\*IMPORTANT: 24vac Models REQUIRE HPC/SEBCO 24vac, 100W Power Supply pg. 58**  
**SOLD SEPARATELY (EI INSERT):** On/Off Models 120VAC- Remote: 578-C: See Pg. 58.

See Pg. 9 for FPPK System Features



### Push Button/Flame Sense Models - FPPK Flex Series Specifications

Size	Gas type	Nozzle	Std Model	Nozzle	Std Remote Small Tank Model	Burner	Max BTU	Nozzle BTU
18"	Natural Gas	TOR-	FPPK18-SQ-FLEX-NG			12" Penta	65k	65k
	Liquid Propane	TOR-	FPPK18-SQ-FLEX-LP	TOR-	FPPK18-SQ-FLEX-LP-ST*			
24"	Natural Gas	TOR-	FPPK24-SQ-FLEX-NG			18" Penta	90k	125k
	Liquid Propane	TOR-	FPPK24-SQ-FLEX-LP	TOR-	FPPK24-SQ-FLEX-LP-ST*			
30"	Natural Gas	TOR-	FPPK30-SQ-FLEX-NG			24" Penta	140k	150k
	Liquid Propane	TOR-	FPPK30-SQ-FLEX-LP					
36"	Natural Gas	TOR-	FPPK36-SQ-FLEX-NG			30" Penta	140k	175k
	Liquid Propane	TOR-	FPPK36-SQ-FLEX-LP					

See Pg. 9 for MLFPK System Features



### Match Lit Models - MLFPK Flex Series Specifications

Size	Gas type	Nozzle	Std Model	Nozzle	Std Remote Small Tank Model	Burner	Max BTU	Nozzle BTU
18"	Natural Gas	TOR-	MLFPK18SQ-FLEX-NG			12" Penta	65k	65k
	Liquid Propane	TOR-	MLFPK18SQ-FLEX-LP	TOR-	MLFPK18SQ-FLEX-LP-ST*			
24"	Natural Gas	TOR-	MLFPK24SQ-FLEX-NG			18" Penta	65k	65k
	Liquid Propane	TOR-	MLFPK24SQ-FLEX-LP	TOR-	MLFPK24SQ-FLEX-LP-ST*			
30"	Natural Gas	TOR-	MLFPK30SQ-FLEX-NG			18" Penta	65k	65k
	Liquid Propane	TOR-	MLFPK30SQ-FLEX-LP	TOR-	MLFPK30SQ-FLEX-LP-ST*			

**FPPK & MLFPK MODELS INCLUDE:** Insert: Fully Assembled and Instructions  
**SOLD SEPARATELY: (FPPK-MLFPK) Input Flex Line: SSC24: All models**

**\*IMPORTANT: On Small Tank Units** The BTU's are the same as the non Nozzle units

TOP SELLING SIZES

Need help? Use our fire pit selector at [hpcfire.com](http://hpcfire.com)

Match proper accessories to your fire pit model - see Pg. 64 - 65.

# H-BURNER INSERTS

## EI Series

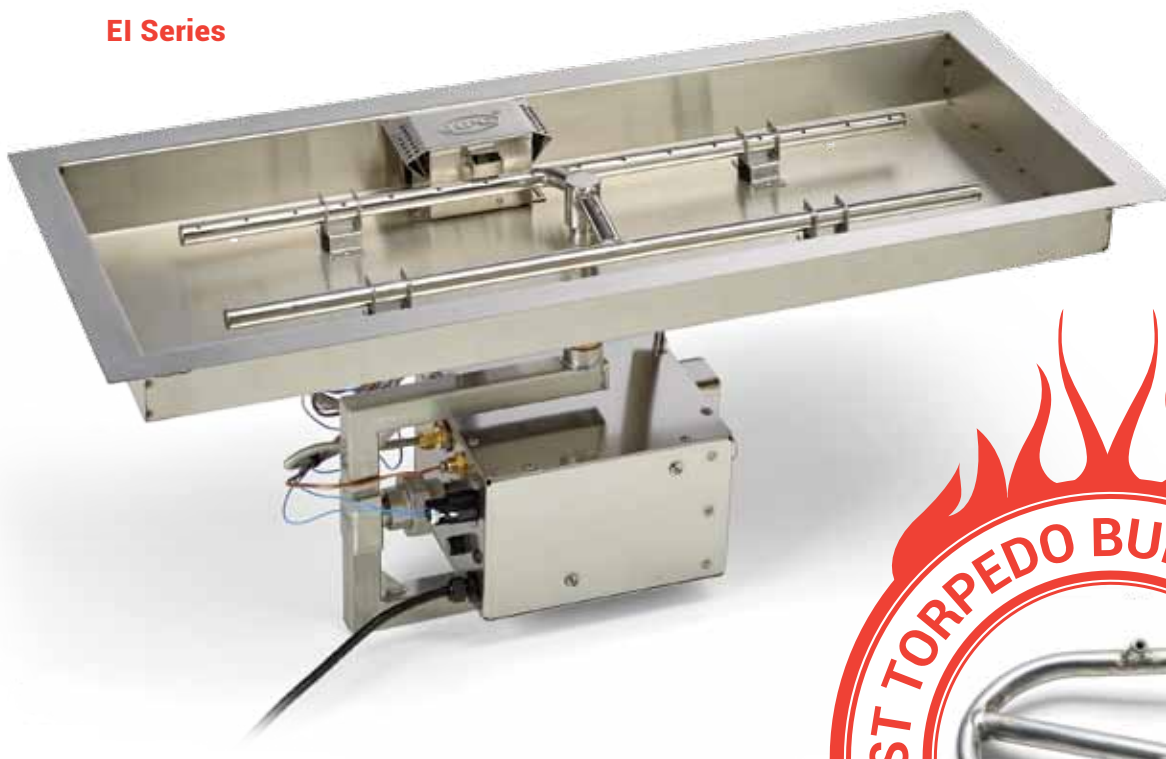

**24VAC MODELS REQUIRE HPC/SEBCO 24vac, 100W Power Supply for inserts ONLY pg. 58**



\*See page 8 for details

### Benefits of H-Burner Inserts:

Sidewall helps with media retention; Pan Lip provides for recessed burner / blowout box.

### Features of H-Burner Inserts:

Made of #304, 18 gauge Stainless Steel, Raised hub H-burner for water prevention, Bolted gas fitting for strength, Weep holes for drainage

\*Lifetime Warranty on burners

## MLFPK Series



## FPPK Series



**\*IMPORTANT: On Small Tank Units** The BTU's are the same as the non Nozzle units

## ACCESSORIES



**EI Accessories (Pg. 58):**  
Timers, Power Supplies, E-Stop

**MLFPK Paver Bracket - Pg. 49**

**Wind Guards: Pg. 46**

**Covers: Pg. 47**

**Media: Pg. 45**

20 **WARNING: California PROP 65:** This product can expose you to Lead & Chromium, which is known to the State of California to cause cancer and birth defects or other reproductive harm. For more information go to [www.P65Warnings.ca.gov](http://www.P65Warnings.ca.gov).

Inspired by safety. Innovated for your lifestyle.



See Pg. 10 for EI System Features



**Electronic Ignition Models - EI Series Specifications**

Size (A")	Power	Gas type	Nozzle	Std Model - Flame ON/OFF	Nozzle	Std Model - Bluetooth (HI/LO)	Burner	Max BTU	Nozzle BTU
24" X 12"	120vac	Natural Gas	TOR-	24X12SSEI-H-NG/120VAC	TOR-	24X12SSEI-H-HI/LO-NG/120VAC	18" X 6" H-Burner	75k	115k
		Liquid Propane	TOR-	24X12SSEI-H-LP/120VAC	TOR-	24X12SSEI-H-HI/LO-LP/120VAC			
* 24vac	120vac	Natural Gas	TOR-	24X12SSEI-H-NG/24VAC	TOR-	24X12SSEI-H-HI/LO-NG/24VAC			
		Liquid Propane	TOR-	24X12SSEI-H-LP/24VAC	TOR-	24X12SSEI-H-HI/LO-LP/24VAC			
30" X 12"	120vac	Natural Gas	TOR-	30X12SSEI-H-NG/120VAC	TOR-	30X12SSEI-H-HI/LO-NG/120VAC	24" X 6" H-Burner	100k	150k
		Liquid Propane	TOR-	30X12SSEI-H-LP/120VAC	TOR-	30X12SSEI-H-HI/LO-LP/120VAC			
* 24vac	120vac	Natural Gas	TOR-	30X12SSEI-H-NG/24VAC	TOR-	30X12SSEI-H-HI/LO-NG/24VAC			
		Liquid Propane	TOR-	30X12SSEI-H-LP/24VAC	TOR-	30X12SSEI-H-HI/LO-LP/24VAC			
36" X 14"	120vac	Natural Gas	TOR-	36X14SSEI-H-NG/120VAC	TOR-	36X14SSEI-H-HI/LO-NG/120VAC	30" X 8" H-Burner	125k	175k
		Liquid Propane	TOR-	36X14SSEI-H-LP/120VAC	TOR-	36X14SSEI-H-HI/LO-LP/120VAC			
* 24vac	120vac	Natural Gas	TOR-	36X14SSEI-H-NG/24VAC	TOR-	36X14SSEI-H-HI/LO-NG/24VAC			
		Liquid Propane	TOR-	36X14SSEI-H-LP/24VAC	TOR-	36X14SSEI-H-HI/LO-LP/24VAC			
42" X 14"	120vac	Natural Gas	TOR-	42X14SSEI-H-NG/120VAC	TOR-	42X14SSEI-H-HI/LO-NG/120VAC	36" X 8" H-Burner	150k	200k
		Liquid Propane	TOR-	42X14SSEI-H-LP/120VAC	TOR-	42X14SSEI-H-HI/LO-LP/120VAC			
* 24vac	120vac	Natural Gas	TOR-	42X14SSEI-H-NG/24VAC	TOR-	42X14SSEI-H-HI/LO-NG/24VAC			
		Liquid Propane	TOR-	42X14SSEI-H-LP/24VAC	TOR-	42X14SSEI-H-HI/LO-LP/24VAC			
54" X 16"	120vac	Natural Gas	TOR-	54X16SSEI-H-NG/120VAC	TOR-	54X16SSEI-H-HI/LO-NG/120VAC	48" X 10" H-Burner	200k	250k
		Liquid Propane	TOR-	54X16SSEI-H-LP/120VAC	TOR-	54X16SSEI-H-HI/LO-LP/120VAC			
* 24vac	120vac	Natural Gas	TOR-	54X16SSEI-H-NG/24VAC	TOR-	54X16SSEI-H-HI/LO-NG/24VAC			
		Liquid Propane	TOR-	54X16SSEI-H-LP/24VAC	TOR-	54X16SSEI-H-HI/LO-LP/24VAC			
66" X 16"	120vac	Natural Gas	TOR-	66X16SSEI-H-NG/120VAC	TOR-	66X16SSEI-H-HI/LO-NG/120VAC	60" X 10" H-Burner	250k	300k
		Liquid Propane	TOR-	66X16SSEI-H-LP/120VAC	TOR-	66X16SSEI-H-HI/LO-LP/120VAC			
* 24vac	120vac	Natural Gas	TOR-	66X16SSEI-H-NG/24VAC	TOR-	66X16SSEI-H-HI/LO-NG/24VAC			
		Liquid Propane	TOR-	66X16SSEI-H-LP/24VAC	TOR-	66X16SSEI-H-HI/LO-LP/24VAC			
78" X 16"	120vac	Natural Gas	TOR-	78X16SSEI-H-NG/120VAC	TOR-	78X16SSEI-H-HI/LO-NG/120VAC	72" X 10" H-Burner	300k	350k
		Liquid Propane	TOR-	78X16SSEI-H-LP/120VAC	TOR-	78X16SSEI-H-HI/LO-LP/120VAC			
* 24vac	120vac	Natural Gas	TOR-	78X16SSEI-H-NG/24VAC	TOR-	78X16SSEI-H-HI/LO-NG/24VAC			
		Liquid Propane	TOR-	78X16SSEI-H-LP/24VAC	TOR-	78X16SSEI-H-HI/LO-LP/24VAC			
90" X 16"	120vac	Natural Gas	TOR-	90X16SSEI-H-NG/120VAC			84" X 10" H-Burner	350k	400k
		Liquid Propane	TOR-	90X16SSEI-H-LP/120VAC					
* 24vac	120vac	Natural Gas	TOR-	90X16SSEI-H-NG/24VAC					
		Liquid Propane	TOR-	90X16SSEI-H-LP/24VAC					

**EI MODELS INCLUDE:** Insert: Fully Assembled. Flex Line: Gas Input and Instructions **SOLD SEPARATELY (EI INSERT):** On/Off Models 120VAC- Remote: 578-C: See Pg. 58.

**\*IMPORTANT: 24vac Models REQUIRE HPC/ SEBCO 24vac, 100W Power Supply pg. 58**

**TOP SELLING SIZES**

See Pg. 9 for FPPK System Features



**Push Button/Flame Sense Models - FPPK Flex Series Specifications**

Size	Gas type	Nozzle	Std Model	Nozzle	Std Remote Small Tank Model	Burner	Max BTU	Nozzle BTU
24" X 12"	Natural Gas	TOR-	FPPK24X12-H-FLEX-NG			18" X 6" H Burner	75k	115k
	Liquid Propane	TOR-	FPPK24X12-H-FLEX-LP	TOR-	FPPK24X12-H-FLEX-LP-ST*			
30" X 12"	Natural Gas	TOR-	FPPK30X12-H-FLEX-NG			24" X 6" H burner	90k	150k
	Liquid Propane	TOR-	FPPK30X12-H-FLEX-LP	TOR-	FPPK30X12-H-FLEX-LP-ST*			
36" X 14"	Natural Gas	TOR-	FPPK36X14-H-FLEX-NG			30" X 8" H Burner	90k	150k
	Liquid Propane	TOR-	FPPK36X14-H-FLEX-LP	TOR-	FPPK36X14-H-FLEX-LP-ST*			
42" X 14"	Natural Gas	TOR-	FPPK42X14-H-FLEX-NG			36" X 8" H Burner	140k	200k
	Liquid Propane	TOR-	FPPK42X14-H-FLEX-LP					
54" X 16"	Natural Gas	TOR-	FPPK54X16-H-FLEX-NG			48" X 10" H Burner	140k	200k
	Liquid Propane	TOR-	FPPK54X16-H-FLEX-LP					

See Pg. 9 for MLFPK System Features



**Match Lit Models - MLFPK Flex Series Specifications**

Size	Gas type	Nozzle	Std Model	Nozzle	Std Remote Small Tank Model	Burner	Max BTU	Nozzle BTU
24" X 12"	Natural Gas	TOR-	MLFPK24X12-H-FLEX-NG			18" X 6" H Burner	65k	65k
	Liquid Propane	TOR-	MLFPK24X12-H-FLEX-LP	TOR-	MLFPK24X12-H-FLEX-LP-ST*			
30" X 12"	Natural Gas	TOR-	MLFPK30X12-H-FLEX-NG			24" X 6" H Burner	65k	65k
	Liquid Propane	TOR-	MLFPK30X12-H-FLEX-LP	TOR-	MLFPK30X12-H-FLEX-LP-ST*			
36" X 14"	Natural Gas	TOR-	MLFPK36X14-H-FLEX-NG			30" X 8" H Burner	65k	65k
	Liquid Propane	TOR-	MLFPK36X14-H-FLEX-LP	TOR-	MLFPK36X14-H-FLEX-LP-ST*			

**FPPK & MLFPK MODELS INCLUDE:** Insert: Fully Assembled and Instructions **SOLD SEPARATELY: (FPPK-MLFPK) Input Flex Line: SSC24: All models**

Match proper accessories to your fire pit model - see Pg. 64 - 65.

Need help? Use our fire pit selector at [hpcfire.com](http://hpcfire.com)

## S-FIRE INSERTS

### EI Series

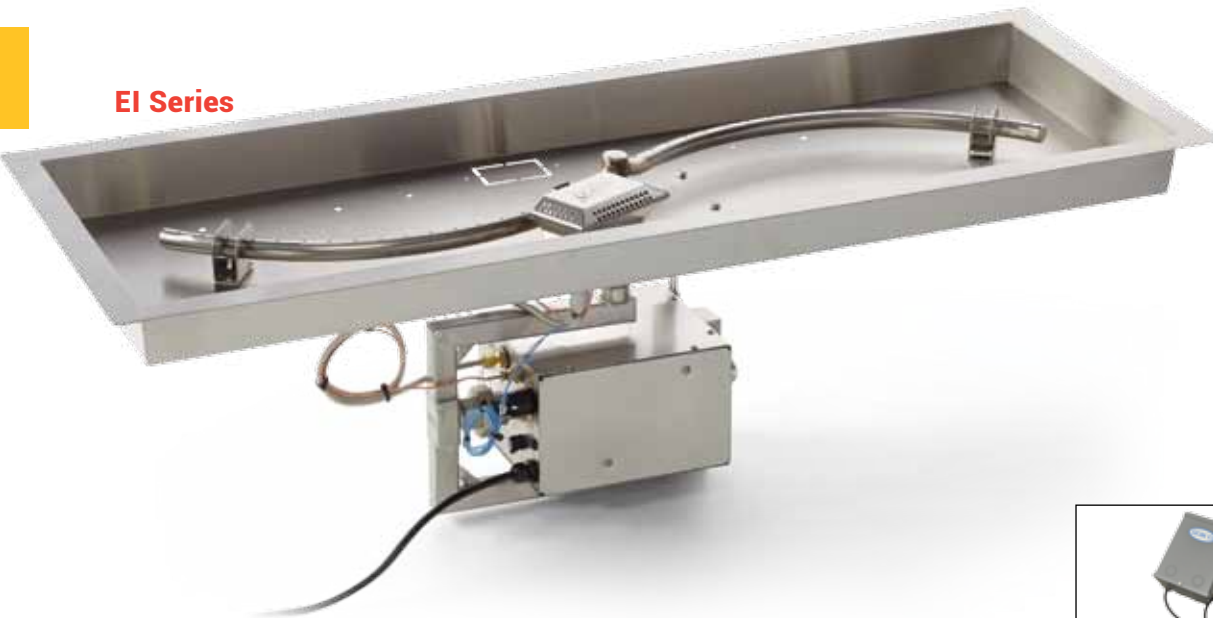

**24VAC MODELS  
REQUIRE HPC/  
SEBCO 24vac, 100W  
Power Supply for  
inserts ONLY pg. 58**

#### Benefits of an S-Fire Insert:

Sidewall helps with media retention; Pan Lip provides for recessed burner / blowout box.

#### Features:

Made of #304, 18 gauge Stainless Steel, Raised hub S-Fire burner for water prevention, Bolted gas fitting for strength, Weep holes for drainage.

\*Lifetime Warranty on burners

### MLFPK Series



### FPPK Series



**SIK36 -  
MANUAL SPARK  
IGNITION** for  
match lit fire pits  
pg. 50

## ACCESSORIES



**EI Accessories (Pg. 58):**  
Timers, Power Supplies, E-Stop

**MLFPK Paver  
Bracket - Pg. 49**

**Wind Guards:**  
Pg. 46

**Covers:**  
Pg. 47

**Media:**  
Pg. 45



See Pg. 10 for EI System Features



**Electronic Ignition Models - EI Series Specifications**

Size	Power	Gas type	Model - Flame ON/OFF	Model - Bluetooth (HI/LO)	Burner	Max BTU
<b>36" X 14"</b>	120vac	Natural Gas	36X14SSEI-S-NG/120VAC	36X14SSEI-S-HI/LO-NG/120VAC	30" X 8" S-Fire	75k
		Liquid Propane	36X14SSEI-S-LP/120VAC	36X14SSEI-S-HI/LO-LP/120VAC		
	* 24vac	Natural Gas	36X14SSEI-S-NG/24VAC	36X14SSEI-S-HI/LO-NG/24VAC		
		Liquid Propane	36X14SSEI-S-LP/24VAC	36X14SSEI-S-HI/LO-LP/24VAC		
<b>42" X 14"</b>	120vac	Natural Gas	42X14SSEI-S-NG/120VAC	42X14SSEI-S-HI/LO-NG/120VAC	36" X 8" S-Fire	85k
		Liquid Propane	42X14SSEI-S-LP/120VAC	42X14SSEI-S-HI/LO-LP/120VAC		
	* 24vac	Natural Gas	42X14SSEI-S-NG/24VAC	42X14SSEI-S-HI/LO-NG/24VAC		
		Liquid Propane	42X14SSEI-S-LP/24VAC	42X14SSEI-S-HI/LO-LP/24VAC		
<b>54" X 16"</b>	120vac	Natural Gas	54X16SSEI-S-NG/120VAC	54X16SSEI-S-HI/LO-NG/120VAC	48" X 10" S-Fire	110k
		Liquid Propane	54X16SSEI-S-LP/120VAC	54X16SSEI-S-HI/LO-LP/120VAC		
	* 24vac	Natural Gas	54X16SSEI-S-NG/24VAC	54X16SSEI-S-HI/LO-NG/24VAC		
		Liquid Propane	54X16SSEI-S-LP/24VAC	54X16SSEI-S-HI/LO-LP/24VAC		
<b>66" X 16"</b>	120vac	Natural Gas	66X16SSEI-S-NG/120VAC	66X16SSEI-S-HI/LO-NG/120VAC	60" X 10" S-Fire	135k
		Liquid Propane	66X16SSEI-S-LP/120VAC	66X16SSEI-S-HI/LO-LP/120VAC		
	* 24vac	Natural Gas	66X16SSEI-S-NG/24VAC	66X16SSEI-S-HI/LO-NG/24VAC		
		Liquid Propane	66X16SSEI-S-LP/24VAC	66X16SSEI-S-HI/LO-LP/24VAC		
<b>78" X 16"</b>	120vac	Natural Gas	78X16SSEI-S-NG/120VAC	78X16SSEI-S-HI/LO-NG/120VAC	72" X 10" S-Fire	165k
		Liquid Propane	78X16SSEI-S-LP/120VAC	78X16SSEI-S-HI/LO-LP/120VAC		
	* 24vac	Natural Gas	78X16SSEI-S-NG/24VAC	78X16SSEI-S-HI/LO-NG/24VAC		
		Liquid Propane	78X16SSEI-S-LP/24VAC	78X16SSEI-S-HI/LO-LP/24VAC		

**EI MODELS INCLUDE:** *Insert: Fully Assembled. Flex Line: Gas Input and Instructions SOLD SEPARATELY (EI INSERT): On/Off Models 120VAC- Remote: 578-C: See Pg. 58.* **\*IMPORTANT: 24vac Models REQUIRE HPC/ SEBCO 24vac, 100W Power Supply pg. 58**

See Pg. 9 for FPPK System Features



**Push Button/Flame Sense Models - FPPK Flex Series Specifications**

Size	Gas type	Model	Remote Small Tank Model	Burner	Max BTU	* Flex Line
<b>36" X 14"</b>	Natural Gas	FPPK36X14-S-FLEX-NG		30" X 8" S-Fire	75k	36"
	Liquid Propane	FPPK36X14-S-FLEX-LP	FPPK36X14-S-FLEX-LP-ST			
<b>42" X 14"</b>	Natural Gas	FPPK42X14-S-FLEX-NG		36" X 8" S-Fire	90k	36"
	Liquid Propane	FPPK42X14-S-FLEX-LP	FPPK42X14-S-FLEX-LP-ST			
<b>54" X 16"</b>	Natural Gas	FPPK54X16-S-FLEX-NG		48" X 10" S-Fire	140k	36"
	Liquid Propane	FPPK54X16-S-FLEX-LP				

See Pg. 9 for MLFPK System Features



**Match Lit Models - MLFPK Flex Series Specifications**

Size	Gas type	Model	Remote Small Tank Model	Burner	Max BTU	* Flex Line
<b>36" X 14"</b>	Natural Gas	MLFPK36X14-S-FLEX-NG		30" X 8" S-Fire	65k	36"
	Liquid Propane	MLFPK36X14-S-FLEX-LP	MLFPK36X14-S-FLEX-LP-ST			

**FPPK & MLFPK MODELS INCLUDE:** *Insert: Fully Assembled and Instructions SOLD SEPARATELY: (FPPK-MLFPK) Input Flex Line: SSC24: All models*

Note: There are no Torpedo Burners "nozzled" available for the S-Fire Series. We currently only have the Conventional "without nozzles" Burners for this series.

TOP SELLING SIZES

Need help? Use our fire pit selector at [hpcfire.com](http://hpcfire.com)

Match proper accessories to your fire pit model - see Pg. 64 - 65.

# TROUGH INSERTS

**EI Series**

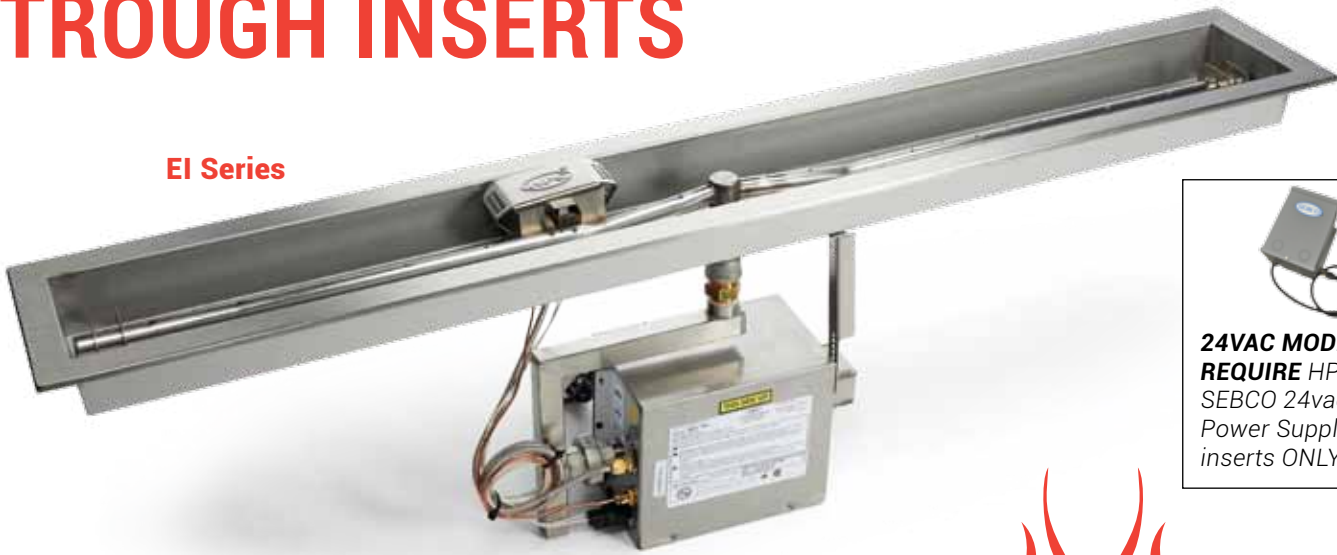

  
**24VAC MODELS**  
**REQUIRE** HPC/  
 SEBCO 24vac, 100W  
 Power Supply for  
 inserts ONLY pg. 58

**Benefits of a Trough Insert:**

Sidewall helps with media retention; Pan Lip provides for recessed burner / blowout box.

**Features:**

Made of #304 Stainless Steel (48" and smaller- 18g, 60" and larger- 16g)  
 Sidewalls adds rigidity- stronger than flat pans  
 Weep holes for drainage  
 \*Lifetime Warranty on burners



\*See page 8 for details



**SIK36 -**  
**MANUAL SPARK**  
**IGNITION** for  
 match lit fire pits  
 pg. 50

**MLFPK Series**



**FPPK Series**



**\*IMPORTANT: On Small Tank Units** The BTU's are the same as the non Nozzle units

## ACCESSORIES



**EI Accessories (Pg. 58):**  
 Timers, Power Supplies, E-Stop

**MLFPK Paver**  
**Bracket - Pg. 49**

**Wind Guards:**  
 Pg. 46

**Covers:**  
 Pg. 47

**Media:**  
 Pg. 45

24 **⚠ WARNING: California PROP 65:** This product can expose you to Lead & Chromium, which is known to the State of California to cause cancer and birth defects or other reproductive harm. For more information go to [www.P65Warnings.ca.gov](http://www.P65Warnings.ca.gov).

Inspired by safety. Innovated for your lifestyle.





See Pg. 10 for EI System Features



**Electronic Ignition Models - EI Series Specifications**

Size	Power	Gas type	Nozzle	Std Model - Flame ON/OFF	Nozzle	Std Model - Bluetooth (HI/LO)	Burner	Max BTU	Nozzle BTU
24"	120vac	Natural Gas	TOR-	24SSEI-TRGH-NG/120VAC	TOR-	24SSEI-TRGH-HI/LO-NG/120VAC	24" T-Burner	50k	75k
		Liquid Propane	TOR-	24SSEI-TRGH-LP/120VAC	TOR-	24SSEI-TRGH-HI/LO-LP/120VAC			
* 24vac	120vac	Natural Gas	TOR-	24SSEI-TRGH-NG/24VAC	TOR-	24SSEI-TRGH-HI/LO-NG/24VAC			
		Liquid Propane	TOR-	24SSEI-TRGH-LP/24VAC	TOR-	24SSEI-TRGH-HI/LO-LP/24VAC			
36"	120vac	Natural Gas	TOR-	36SSEI-TRGH-NG/120VAC	TOR-	36SSEI-TRGH-HI/LO-NG/120VAC	36" T-Burner	75k	115k
		Liquid Propane	TOR-	36SSEI-TRGH-LP/120VAC	TOR-	36SSEI-TRGH-HI/LO-LP/120VAC			
* 24vac	120vac	Natural Gas	TOR-	36SSEI-TRGH-NG/24VAC	TOR-	36SSEI-TRGH-HI/LO-NG/24VAC			
		Liquid Propane	TOR-	36SSEI-TRGH-LP/24VAC	TOR-	36SSEI-TRGH-HI/LO-LP/24VAC			
48"	120vac	Natural Gas	TOR-	48SSEI-TRGH-NG/120VAC	TOR-	48SSEI-TRGH-HI/LO-NG/120VAC	48" T-Burner	100k	150k
		Liquid Propane	TOR-	48SSEI-TRGH-LP/120VAC	TOR-	48SSEI-TRGH-HI/LO-LP/120VAC			
* 24vac	120vac	Natural Gas	TOR-	48SSEI-TRGH-NG/24VAC	TOR-	48SSEI-TRGH-HI/LO-NG/24VAC			
		Liquid Propane	TOR-	48SSEI-TRGH-LP/24VAC	TOR-	48SSEI-TRGH-HI/LO-LP/24VAC			
60"	120vac	Natural Gas	TOR-	60SSEI-TRGH-NG/120VAC	TOR-	60SSEI-TRGH-HI/LO-NG/120VAC	60" T-Burner	125k	175k
		Liquid Propane	TOR-	60SSEI-TRGH-LP/120VAC	TOR-	60SSEI-TRGH-HI/LO-LP/120VAC			
* 24vac	120vac	Natural Gas	TOR-	60SSEI-TRGH-NG/24VAC	TOR-	60SSEI-TRGH-HI/LO-NG/24VAC			
		Liquid Propane	TOR-	60SSEI-TRGH-LP/24VAC	TOR-	60SSEI-TRGH-HI/LO-LP/24VAC			
72"	120vac	Natural Gas	TOR-	72SSEI-TRGH-NG/120VAC	TOR-	72SSEI-TRGH-HI/LO-NG/120VAC	72" T-Burner	150k	200k
		Liquid Propane	TOR-	72SSEI-TRGH-LP/120VAC	TOR-	72SSEI-TRGH-HI/LO-LP/120VAC			
* 24vac	120vac	Natural Gas	TOR-	72SSEI-TRGH-NG/24VAC	TOR-	72SSEI-TRGH-HI/LO-NG/24VAC			
		Liquid Propane	TOR-	72SSEI-TRGH-LP/24VAC	TOR-	72SSEI-TRGH-HI/LO-LP/24VAC			
96"	120vac	Natural Gas	TOR-	96SSEI-TRGH-NG/120VAC	TOR-	96SSEI-TRGH-HI/LO-NG/120VAC	96" T-Burner	200k	250k
		Liquid Propane	TOR-	96SSEI-TRGH-LP/120VAC	TOR-	96SSEI-TRGH-HI/LO-LP/120VAC			
* 24vac	120vac	Natural Gas	TOR-	96SSEI-TRGH-NG/24VAC	TOR-	96SSEI-TRGH-HI/LO-NG/24VAC			
		Liquid Propane	TOR-	96SSEI-TRGH-LP/24VAC	TOR-	96SSEI-TRGH-HI/LO-LP/24VAC			

**EI MODELS INCLUDE:** Insert: Fully Assembled. Flex Line: Gas Input and Instructions **\*IMPORTANT: 24vac Models REQUIRE HPC/SEBCO 24vac, 100W Power Supply pg. 58**  
**SOLD SEPARATELY (EI INSERT):** On/Off Models 120VAC- Remote: 578-C: See Pg. 58.

See Pg. 9 for FPPK System Features



**Push Button/Flame Sense Models - FPPK Flex Series Specifications**

Size	Gas type	Nozzle	Std Model	Nozzel	Std Remote Small Tank Model	Burner	Max BTU	Nozzle BTU
24"	Natural Gas	TOR-	FPPK24-TRGH-FLEX-NG			24" T-Burner	50k	75k
	Liquid Propane	TOR-	FPPK24-TRGH-FLEX-LP	TOR-	FPPK24-TRGH-FLEX-LP-ST*			
36"	Natural Gas	TOR-	FPPK36-TRGH-FLEX-NG			36" T-Burner	75k	115k
	Liquid Propane	TOR-	FPPK36-TRGH-FLEX-LP	TOR-	FPPK36-TRGH-FLEX-LP-ST*			
48"	Natural Gas	TOR-	FPPK48-TRGH-FLEX-NG			48" T-Burner	90k	150k
	Liquid Propane	TOR-	FPPK48-TRGH-FLEX-LP	TOR-	FPPK48-TRGH-FLEX-LP-ST*			
60"	Natural Gas	TOR-	FPPK60-TRGH-FLEX-NG			60" T-Burner	90k	175k
	Liquid Propane	TOR-	FPPK60-TRGH-FLEX-LP	TOR-	FPPK60-TRGH-FLEX-LP-ST*			
72"	Natural Gas	TOR-	FPPK72-TRGH-FLEX-NG			72" T-Burner	140k	200k
	Liquid Propane	TOR-	FPPK72-TRGH-FLEX-LP					
96"	Natural Gas	TOR-	FPPK96-TRGH-FLEX-NG			96" T-Burner	140k	250k
	Liquid Propane	TOR-	FPPK96-TRGH-FLEX-LP					

See Pg. 9 for MLFPK System Features



**Match Lit Models - MLFPK Flex Series Specifications**

Size	Gas type	Nozzle	Std Model	Nozzle	Std Remote Small Tank Model	Burner	Max BTU	Nozzle BTU
24"	Natural Gas	TOR-	MLFPK24 TRGH-FLEX-NG			24" T-Burner	50k	65k
	Liquid Propane	TOR-	MLFPK24 TRGH-FLEX-LP	TOR-	MLFPK24 TRGH-FLEX-LP-ST*			
36"	Natural Gas	TOR-	MLFPK36 TRGH-FLEX-NG			36" T-Burner	65k	65k
	Liquid Propane	TOR-	MLFPK36 TRGH-FLEX-LP	TOR-	MLFPK36 TRGH-FLEX-LP-ST*			
48"	Natural Gas	TOR-	MLFPK48 TRGH-FLEX-NG			48" T-Burner	65k	65k
	Liquid Propane	TOR-	MLFPK48 TRGH-FLEX-LP	TOR-	MLFPK48 TRGH-FLEX-LP-ST*			

**FPPK & MLFPK MODELS INCLUDE:** Insert: Fully Assembled and Instructions  
**SOLD SEPARATELY: (FPPK-MLFPK) Input Flex Line: SSC24: All models**



TOP SELLING SIZES

Need help? Use our fire pit selector at [hpcfire.com](http://hpcfire.com)

Match proper accessories to your fire pit model - see Pg. 64 - 65.

## INTERLINK INSERTS

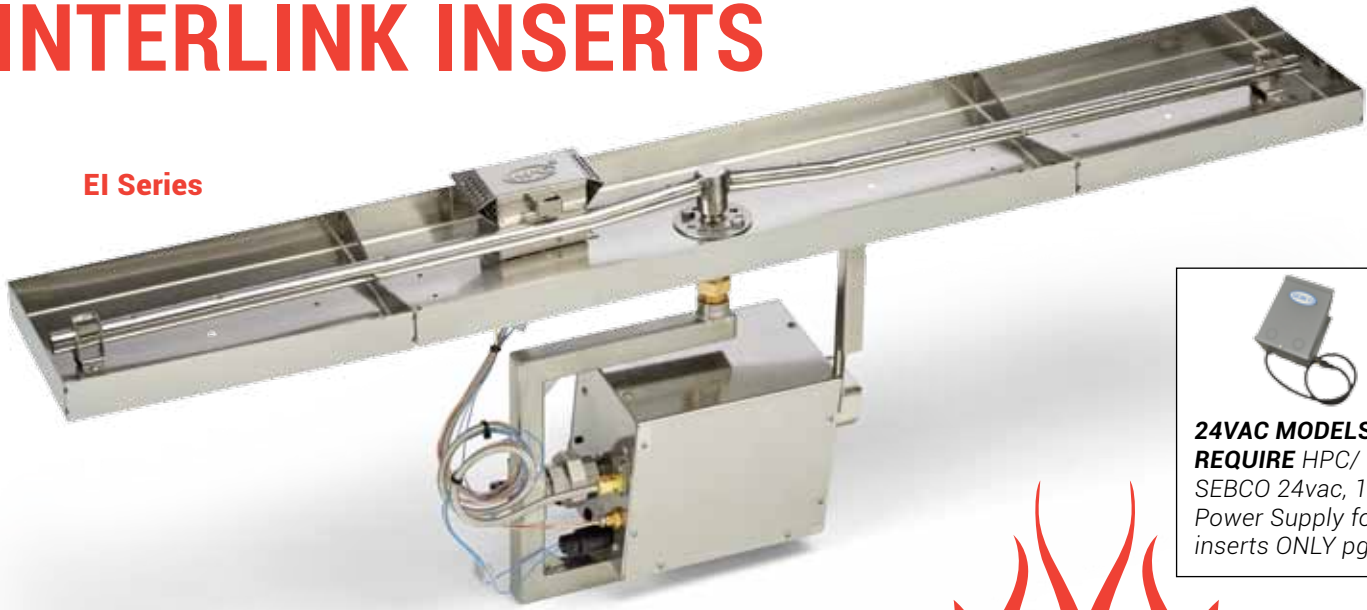
### EI Series

**24VAC MODELS  
REQUIRE HPC/  
SEBCO 24vac, 100W  
Power Supply for  
inserts ONLY pg. 58**

#### Benefits of a Linear Insert:

Partial sidewall for media retention; used in enclosures that have recess mount of insert.

#### Features:

- Made of #304, 18 gauge Stainless Steel
- Sidewalls adds rigidity- stronger than flat pans
- Removable center section on larger models
- Raised hub T-Burner for water prevention
- Secure gas fitting for strength
- Weep holes for drainage
- \*Lifetime Warranty on burners



\*See page 8 for details

### MLFPK Series



### FPPK Series

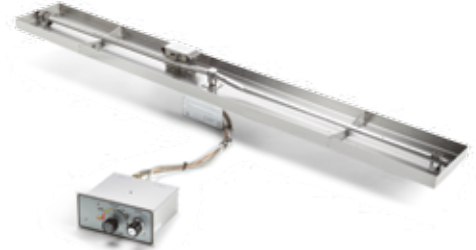

**\*IMPORTANT: On Small Tank Units** The BTU's are the same as the non Nozzle units

## ACCESSORIES



**EI Accessories (Pg. 58):**  
Timers, Power Supplies, E-Stop

**MLFPK Paver  
Bracket - Pg. 49**

**Wind Guards:  
Pg. 46**

**Covers:  
Pg. 47**

**Media:  
Pg. 45**



See Pg. 10 for EI System Features



**Electronic Ignition Models - EI Series Specifications**

Size	Power	Gas type	Nozzle	Std Model - Flame ON/OFF	Nozzle	Std Model - Bluetooth (HI/LO)	Burner	Max BTU	Nozzle BTU
25" X 8"	120vac	Natural Gas Liquid Propane	TOR- TOR-	25X8SSEI-L-NG/120VAC 25X8SSEI-L-LP/120VAC	TOR- TOR-	25X8SSEI-L-HI/LO-NG/120VAC 25X8SSEI-L-HI/LO-LP/120VAC	24" T-Burner	50k	75k
	* 24vac	Natural Gas Liquid Propane	TOR- TOR-	25X8SSEI-L-NG/24VAC 25X8SSEI-L-LP/24VAC	TOR- TOR-	25X8SSEI-L-HI/LO-NG/24VAC 25X8SSEI-L-HI/LO-LP/24VAC			
37" X 8"	120vac	Natural Gas Liquid Propane	TOR- TOR-	37X8SSEI-L-NG/120VAC 37X8SSEI-L-LP/120VAC	TOR- TOR-	37X8SSEI-L-HI/LO-NG/120VAC 37X8SSEI-L-HI/LO-LP/120VAC	36" T-Burner	75k	115k
	* 24vac	Natural Gas Liquid Propane	TOR- TOR-	37X8SSEI-L-NG/24VAC 37X8SSEI-L-LP/24VAC	TOR- TOR-	37X8SSEI-L-HI/LO-NG/24VAC 37X8SSEI-L-HI/LO-LP/24VAC			
49" X 8"	120vac	Natural Gas Liquid Propane	TOR- TOR-	49X8SSEI-L-NG/120VAC 49X8SSEI-L-LP/120VAC	TOR- TOR-	49X8SSEI-L-HI/LO-NG/120VAC 49X8SSEI-L-HI/LO-LP/120VAC	48" T-Burner	100k	150k
	* 24vac	Natural Gas Liquid Propane	TOR- TOR-	49X8SSEI-L-NG/24VAC 49X8SSEI-L-LP/24VAC	TOR- TOR-	49X8SSEI-L-HI/LO-NG/24VAC 49X8SSEI-L-HI/LO-LP/24VAC			
61" X 8"	120vac	Natural Gas Liquid Propane	TOR- TOR-	61X8SSEI-L-NG/120VAC 61X8SSEI-L-LP/120VAC	TOR- TOR-	61X8SSEI-L-HI/LO-NG/120VAC 61X8SSEI-L-HI/LO-LP/120VAC	60" T-Burner	125k	175k
	* 24vac	Natural Gas Liquid Propane	TOR- TOR-	61X8SSEI-L-NG/24VAC 61X8SSEI-L-LP/24VAC	TOR- TOR-	61X8SSEI-L-HI/LO-NG/24VAC 61X8SSEI-L-HI/LO-LP/24VAC			
73" X 8"	120vac	Natural Gas Liquid Propane	TOR- TOR-	73X8SSEI-L-NG/120VAC 73X8SSEI-L-LP/120VAC	TOR- TOR-	73X8SSEI-L-HI/LO-NG/120VAC 73X8SSEI-L-HI/LO-LP/120VAC	72" T-Burner	150k	200k
	* 24vac	Natural Gas Liquid Propane	TOR- TOR-	73X8SSEI-L-NG/24VAC 73X8SSEI-L-LP/24VAC	TOR- TOR-	73X8SSEI-L-HI/LO-NG/24VAC 73X8SSEI-L-HI/LO-LP/24VAC			
97" X 8"	120vac	Natural Gas Liquid Propane	TOR- TOR-	97X8SSEI-L-NG/120VAC 97X8SSEI-L-LP/120VAC	TOR- TOR-	97X8SSEI-L-HI/LO-NG/120VAC 97X8SSEI-L-HI/LO-LP/120VAC	96" T-Burner	200k	250k
	* 24vac	Natural Gas Liquid Propane	TOR- TOR-	97X8SSEI-L-NG/24VAC 97X8SSEI-L-LP/24VAC	TOR- TOR-	97X8SSEI-L-HI/LO-NG/24VAC 97X8SSEI-L-HI/LO-LP/24VAC			
121" X 8"	120vac	Natural Gas Liquid Propane	TOR- TOR-	121X8SSEI-L-NG/120VAC 121X8SSEI-L-LP/120VAC	TOR- TOR-	121X8SSEI-L-HI/LO-NG/120VAC 121X8SSEI-L-HI/LO-LP/120VAC	120" T-Burner	250k	300k
	* 24vac	Natural Gas Liquid Propane	TOR- TOR-	121X8SSEI-L-NG/24VAC 121X8SSEI-L-LP/24VAC	TOR- TOR-	121X8SSEI-L-HI/LO-NG/24VAC 121X8SSEI-L-HI/LO-LP/24VAC			

**EI MODELS INCLUDE:** Insert: Fully Assembled. Flex Line: Gas Input and Instructions  
**SOLD SEPARATELY (EI INSERT):** On/Off Models 120VAC- Remote: 578-C: See Pg. 58.

**\*IMPORTANT: 24vac Models REQUIRE HPC/ SEBCO 24vac, 100W Power Supply pg. 58**

**TOP SELLING SIZES**

See Pg. 9 for FPPK System Features



**Push Button/Flame Sense Models - FPPK Flex Series Specifications**

Size	Gas type	Nozzle	Std Model	Nozzle	Std Remote Small Tank Model	Burner	Max BTU	Nozzle BTU
25" X 8"	Natural Gas Liquid Propane	TOR- TOR-	FPPK25X8-L-FLEX-NG FPPK25X8-L-FLEX-LP	TOR-	FPPK25X8-L-FLEX-LP-ST*	24" T-Burner	50k	75k
	37" X 8"	Natural Gas Liquid Propane	TOR- TOR-	FPPK37X8-L-FLEX-NG FPPK37X8-L-FLEX-LP	TOR-			
49" X 8"	Natural Gas Liquid Propane	TOR- TOR-	FPPK49X8-L-FLEX-NG FPPK49X8-L-FLEX-LP	TOR-	FPPK49X8-L-FLEX-LP-ST*	48" T-Burner	90k	150k
	61" X 8"	Natural Gas Liquid Propane	TOR- TOR-	FPPK61X8-L-FLEX-NG FPPK61X8-L-FLEX-LP	TOR-			
73" X 8"		Natural Gas Liquid Propane	TOR- TOR-	FPPK73X8-L-FLEX-NG FPPK73X8-L-FLEX-LP			72" T-Burner	140k
	97" X 8"	Natural Gas Liquid Propane	TOR- TOR-	FPPK97X8-L-FLEX-NG FPPK97X8-L-FLEX-LP				

See Pg. 9 for MLFPK System Features



**Match Lit Models - MLFPK Flex Series Specifications**

Size	Gas type	Nozzle	Std Model	Nozzle	Std Remote Small Tank Model	Burner	Max BTU	Nozzle BTU
25" X 8"	Natural Gas Liquid Propane	TOR- TOR-	MLFPK25X8-L-FLEX-NG MLFPK25X8-L-FLEX-LP	TOR-	MLFPK25X8-L-FLEX-LP-ST*	24" T-Burner	50k	65k
	37" X 8"	Natural Gas Liquid Propane	TOR- TOR-	MLFPK37X8-L-FLEX-NG MLFPK37X8-L-FLEX-LP	TOR-			
49" X 8"		Natural Gas Liquid Propane	TOR- TOR-	MLFPK49X8-L-FLEX-NG MLFPK49X8-L-FLEX-LP	TOR-	MLFPK49X8-L-FLEX-LP-ST*	48" T-Burner	65k

**FPPK & MLFPK MODELS INCLUDE:** Insert: Fully Assembled and Instructions  
**SOLD SEPARATELY: (FPPK-MLFPK) Input Flex Line: SSC24: All models**

Match proper accessories to your fire pit model - see Pg. 64 - 65.

# OUTDOOR FIREPLACE BURNERS

## FIREPLACE SERIES ALL-IN-ONE BURNERS

HPC is broadening the field of outdoor gas fires by introducing a new line of Outdoor Gas Fireplace Burners. Ideally suited for retrofit or new construction applications, these Outdoor Fireplace Burners come in two

distinctive styles: A Dual Step Burner in two sizes; and a Linear Burner that comes in six sizes (up to 87" long)!

## SELLING POINTS

### Adjustable Feet



High Setting



Low Setting

### EI Pilot



Two Designs: Dual Step & Linear  
Linear Burners fit fireplaces that measure 36" up to 96"  
Bluetooth Electronic Ignition and Flame Sense Models  
CSA Approved for Safety Assurance  
Low Profile with Multiple Media Choices  
NEMA-rated Valve for Weather Resistance  
Limited Lifetime Warranty on Burners and Pans



### Benefits of a Dual Step Insert:

Bluetooth Electronic Ignition and Flame Sense Models  
CSA Certified for Safety Assurance  
Low Profile with Multiple Media Choices  
NEMA-rated Valve for Weather Resistance  
\*Lifetime Warranty on burners and pan

### PBFS Series

### EI Series

### Features:

Lifetime Warranty on Burners and Pans  
2 sizes available to fit the most popular outdoor fireplaces 36" & 42" in width  
H-Burner design with rear leg elevated  
Burner pan is rear height adjustable for flame presence flexibility  
Weep holes integrated in burner for water shedding  
Stainless Steel, Powder Coated Black

## DUAL STEP - H-BURNER - ELECTRONIC IGNITION (EI)

Size	Power	Gas type	Model - Flame ON/OFF	Model - Bluetooth (HI/LO)	Burner	Max BTU	Pan Size	Fits Fireplace Size
22"	120vac	Natural Gas	DBOF22EI-NG/120VAC	DBOF22EI-HI/LO-NG/120VAC	21"	90k	22" X 10"	36"
		Liquid Propane	DBOF22EI-LP/120VAC	DBOF22EI-HI/LO-LP/120VAC				
	24vac	Natural Gas	DBOF22EI-NG/24VAC	DBOF22EI-HI/LO-NG/24VAC	21"	90k	22" X 10"	36"
		Liquid Propane	DBOF22EI-LP/24VAC	DBOF22EI-HI/LO-LP/24VAC				
28"	120vac	Natural Gas	DBOF28EI-NG/120VAC	DBOF28EI-HI/LO-NG/120VAC	27"	110k	28" X 10"	42"
		Liquid Propane	DBOF28EI-LP/120VAC	DBOF28EI-HI/LO-LP/120VAC				
	24vac	Natural Gas	DBOF28EI-NG/24VAC	DBOF28EI-HI/LO-NG/24VAC	27"	110k	28" X 10"	42"
		Liquid Propane	DBOF28EI-LP/24VAC	DBOF28EI-HI/LO-LP/24VAC				

## DUAL STEP - H-BURNER - PUSH BUTTON / FLAME SENSING (PBFS) WITH CONTROL BOX

Size	Gas type	Model	Burner	Max BTU	Pan Size	Fits Fireplace size
27"	Natural Gas	DBOF27PBFS-NG	21"	90k	27" X 10" (With Control Box)	36"
	Liquid Propane	DBOF27PBFS-LP				
33"	Natural Gas	DBOF33PBFS-NG	27"	110k	33" X 10" (With Control Box)	42"
	Liquid Propane	DBOF33PBFS-LP				

28 **WARNING: California PROP 65:** This product can expose you to Lead & Chromium, which is known to the State of California to cause cancer and birth defects or other reproductive harm. For more information go to [www.P65Warnings.ca.gov](http://www.P65Warnings.ca.gov).

Inspired by safety. Innovated for your lifestyle.



**EI Series**



**Benefits of a Linear Insert:**

Bluetooth Electronic Ignition and Flame Sense Models  
 CSA Certified for Safety Assurance  
 Linear Burners fit fireplaces that measure 36" up to 96"  
 Low Profile with Multiple Media Choices  
 NEMA-rated Valve for Weather Resistance  
 \*Lifetime Warranty on burners and pan



*CSA Certified*

**PBFS Series**



**Features:**

Lifetime Warranty on Burners and Pans  
 6 sizes available for outdoor fireplaces ranging from 36" to 96" in width  
 Low Profile burner design  
 Weep holes integrated in burner for water shedding  
 Stainless Steel, Powder Coated Black

**LINEAR - ELECTRONIC IGNITION (EI)**

Size	Power	Gas type	Model - Flame ON/OFF	Model - Bluetooth (HI/LO)	Burner	Max BTU	Pan Size	Fits Fireplace Size
22"	120vac	Natural Gas	LBOF22EI-NG/120VAC	LBOF22EI-HI/LO-NG/120VAC	21"	50k	22" X 6"	36"
		Liquid Propane	LBOF22EI-LP/120VAC	LBOF22EI-HI/LO-LP/120VAC				
	24vac	Natural Gas	LBOF22EI-NG/24VAC	LBOF22EI-HI/LO-NG/24VAC	21"	50k	22" X 6"	36"
		Liquid Propane	LBOF22EI-LP/24VAC	LBOF22EI-HI/LO-LP/24VAC				
28"	120vac	Natural Gas	LBOF28EI-NG/120VAC	LBOF28EI-HI/LO-NG/120VAC	27"	75k	28" X 6"	42"
		Liquid Propane	LBOF28EI-LP/120VAC	LBOF28EI-HI/LO-LP/120VAC				
	24vac	Natural Gas	LBOF28EI-NG/24VAC	LBOF28EI-HI/LO-NG/24VAC	27"	75k	28" X 6"	42"
		Liquid Propane	LBOF28EI-LP/24VAC	LBOF28EI-HI/LO-LP/24VAC				
46"	120vac	Natural Gas	LBOF46EI-NG/120VAC	LBOF46EI-HI/LO-NG/120VAC	45"	100k	46" X 6"	60"
		Liquid Propane	LBOF46EI-LP/120VAC	LBOF46EI-HI/LO-LP/120VAC				
	24vac	Natural Gas	LBOF46EI-NG/24VAC	LBOF46EI-HI/LO-NG/24VAC	45"	100k	46" X 6"	60"
		Liquid Propane	LBOF46EI-LP/24VAC	LBOF46EI-HI/LO-LP/24VAC				
58"	120vac	Natural Gas	LBOF58EI-NG/120VAC	LBOF58EI-HI/LO-NG/120VAC	57"	110k	58" X 6"	72"
		Liquid Propane	LBOF58EI-LP/120VAC	LBOF58EI-HI/LO-LP/120VAC				
	24vac	Natural Gas	LBOF58EI-NG/24VAC	LBOF58EI-HI/LO-NG/24VAC	57"	110k	58" X 6"	72"
		Liquid Propane	LBOF58EI-LP/24VAC	LBOF58EI-HI/LO-LP/24VAC				
70"	120vac	Natural Gas	LBOF70EI-NG/120VAC	LBOF70EI-HI/LO-NG/120VAC	69"	120k	70" X 6"	84"
		Liquid Propane	LBOF70EI-LP/120VAC	LBOF70EI-HI/LO-LP/120VAC				
	24vac	Natural Gas	LBOF70EI-NG/24VAC	LBOF70EI-HI/LO-NG/24VAC	69"	120k	70" X 6"	84"
		Liquid Propane	LBOF70EI-LP/24VAC	LBOF70EI-HI/LO-LP/24VAC				
82"	120vac	Natural Gas	LBOF82EI-NG/120VAC	LBOF82EI-HI/LO-NG/120VAC	81"	130k	82" X 6"	96"
		Liquid Propane	LBOF82EI-LP/120VAC	LBOF82EI-HI/LO-LP/120VAC				
	24vac	Natural Gas	LBOF82EI-NG/24VAC	LBOF82EI-HI/LO-NG/24VAC	81"	130k	82" X 6"	96"
		Liquid Propane	LBOF82EI-LP/24VAC	LBOF82EI-HI/LO-LP/24VAC				

**LINEAR - PUSH BUTTON / FLAME SENSING (PBFS) WITH CONTROL BOX**

Size	Gas type	Model	Burner	Max BTU	Pan Size	Fits Fireplace size
27"	Natural Gas	LBOF27PBFS-NG	21"	50k	27" X 10" (With Control Box)	36"
	Liquid Propane	LBOF27PBFS-LP				
33"	Natural Gas	LBOF33PBFS-NG	27"	75k	33" X 10" (With Control Box)	42"
	Liquid Propane	LBOF33PBFS-LP				
51"	Natural Gas	LBOF51PBFS-NG	45"	100k	51" X 10" (With Control Box)	60"
	Liquid Propane	LBOF51PBFS-LP				
63"	Natural Gas	LBOF63PBFS-NG	57"	110k	63" X 10" (With Control Box)	72"
	Liquid Propane	LBOF63PBFS-LP				
75"	Natural Gas	LBOF75PBFS-NG	69"	120k	75" X 10" (With Control Box)	84"
	Liquid Propane	LBOF75PBFS-LP				
87"	Natural Gas	LBOF87PBFS-NG	81"	130k	87" X 10" (With Control Box)	96"
	Liquid Propane	LBOF87PBFS-LP				

**TOP SELLING SIZES**

Need help? Use our fire pit selector at [hpcfire.com](http://hpcfire.com)

## COMPLETE FIRE PIT PACKAGES

These units are unfinished to allow the customer to finish with stone, veneer, or stucco to match their surrounding. Units are available in round, octagon, square, and linear shapes. Housings take the guess work out of enclosure construction - especially with the difficult round and octagon shapes. These are 18" tall and are constructed of sturdy 22 gauge galvanized steel material, welded frame, and a 1/2" hardie board shell, and weigh 150 lbs.

**Enclosure ships from North Carolina warehouse on pallet; Fire Pit ships from Ohio warehouse.**

HPC offers complete fire pit packages that include unfinished enclosures fitted with a certified remote electronic ignition (EI), push button/flame sense (FPPK) or match lit (MLFPK) fire pit insert.

**Now, certain models are available sized to fit a small LP tank inside. Door included. See page 34.**



## ROUND ENCLOSURE - PENTA BURNER - SPECIFICATIONS



**EI Models Include:** Enclosure, Fully Assembled Insert, Input Flex Line and Instructions

**FPPK Models Include:** Enclosure, Fully Assembled Insert, Mounting Sleeve and Instructions

**MLFPK Models Include:** Enclosure, Fully Assembled Insert and Instructions



Frame is pre-cut for FPPK or MLFPK.

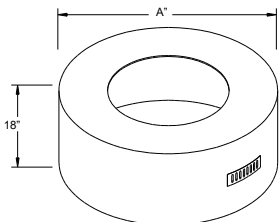
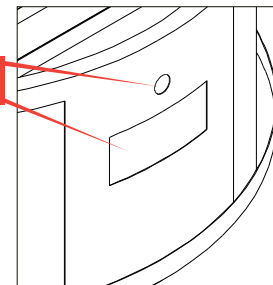

**Size:** 45" diameter, 18" tall  
**Insert:** 25" Bowl Pan, 18" Penta Cladding SQ FT:  
Side: 18.5 - Top: 8.1 - Total: 26.6  
Includes 10% Buffer

**Size:** 54" diameter, 18" tall  
**Insert:** 25" Bowl Pan, 18" Penta Cladding SQ FT:  
Side: 21.1 - Top: 13.5 - Total: 34.6  
Includes 10% Buffer

Ignition	Size (A")	Power	Gas type	Nozzle	Std Model	Max BTU	Nozzle BTU
Electronic Ignition (EI)	45"	120VAC	Natural Gas	TOR	U45R/25SSCEK-NG/120VAC	125k	140k
		24VAC	Liquid Propane	TOR	U45R/25SSCEK-LP/24VAC		
	54"	120VAC	Natural Gas	TOR	U54R/25SSCEK-NG/120VAC	125k	140k
		24VAC	Liquid Propane	TOR	U54R/25SSCEK-LP/24VAC		
Push Button-Flame Sense (FPPK)	45"		Natural Gas	TOR	U45R/FPPK25CEK-NG	90k	140k
			Liquid Propane	TOR	U45R/FPPK25CEK-LP		
	54"		Natural Gas	TOR	U54R/FPPK25CEK-NG	90k	140k
			Liquid Propane	TOR	U54R/FPPK25CEK-LP		
Match Lit (MLFPK)	45"		Natural Gas	TOR	U45R/MLFPK25CEK-NG	65k	65k
			Liquid Propane	TOR	U45R/MLFPK25CEK-LP		
	54"		Natural Gas	TOR	U54R/MLFPK25CEK-NG	65k	65k
			Liquid Propane	TOR	U54R/MLFPK25CEK-LP		

30 **WARNING: California PROP 65:** This product can expose you to Lead & Chromium, which is known to the State of California to cause cancer and birth defects or other reproductive harm. For more information go to [www.P65Warnings.ca.gov](http://www.P65Warnings.ca.gov).

Inspired by safety. Innovated for your lifestyle.

### OCTAGON ENCLOSURE- PENTA BURNER - SPECIFICATIONS



**EI Models Include:** Enclosure, Fully Assembled Insert, Input Flex Line and Instructions

**FPPK Models Include:** Enclosure, Fully Assembled Insert, Mounting Sleeve and Instructions

**MLFPK Models Include:** Enclosure, Fully Assembled Insert and Instructions

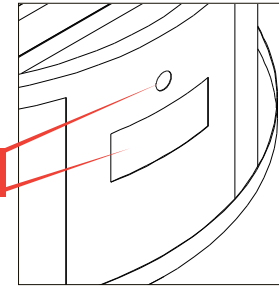

Frame is pre-cut for FPPK or MLFPK.

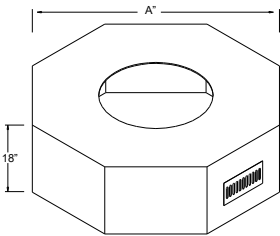

**Size:** 45" diameter, 18" tall  
**Insert:** 25" Bowl Pan, 18" Penta  
**Cladding SQ FT:**  
 Sides: 21 - Top: 9.3 - Total: 30.3  
 Includes 10% Buffer

**Size:** 54" diameter, 18" tall  
**Insert:** 25" Bowl Pan, 18" Penta  
**Cladding SQ FT:**  
 Sides: 24.6 - Top: 14.4 - Total: 39  
 Includes 10% Buffer

Ignition	Size (A")	Power	Gas type	Nozzle	Std Model	Max BTU	Nozzle BTU
Electronic Ignition (EI)	45"	120VAC	Natural Gas	TOR	U450/25SSCEK-NG/120VAC	125k	140k
			Liquid Propane	TOR	U450/25SSCEK-LP/120VAC		
		24VAC	Natural Gas	TOR	U450/25SSCEK-NG/24VAC		
			Liquid Propane	TOR	U450/25SSCEK-LP/24VAC		
	54"	120VAC	Natural Gas	TOR	U540/25SSCEK-NG/120VAC	125k	140k
			Liquid Propane	TOR	U540/25SSCEK-LP/120VAC		
		24VAC	Natural Gas	TOR	U540/25SSCEK-NG/24VAC		
			Liquid Propane	TOR	U540/25SSCEK-LP/24VAC		
Push Button-Flame Sense (FPPK)	45"		Natural Gas	TOR	U450/FPPK25CEK-NG	90k	140k
			Liquid Propane	TOR	U450/FPPK25CEK-LP		
			Natural Gas	TOR	U540/FPPK25CEK-NG	90k	140k
			Liquid Propane	TOR	U540/FPPK25CEK-LP		
Match Lit (MLFPK)	45"		Natural Gas	TOR	U450/MLFPK25CEK-NG	65k	65k
			Liquid Propane	TOR	U450/MLFPK25CEK-LP		
			Natural Gas	TOR	U540/MLFPK25CEK-NG	65k	65k
			Liquid Propane	TOR	U540/MLFPK25CEK-LP		

### SQUARE ENCLOSURE - PENTA BURNER - SPECIFICATIONS



**EI Models Include:** Enclosure, Fully Assembled Insert, Input Flex Line and Instructions

**FPPK Models Include:** Enclosure, Fully Assembled Insert, Mounting Sleeve and Instructions

**MLFPK Models Include:** Enclosure, Fully Assembled Insert and Instructions

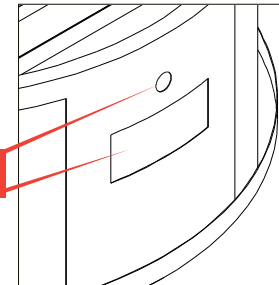

Frame is pre-cut for FPPK or MLFPK.

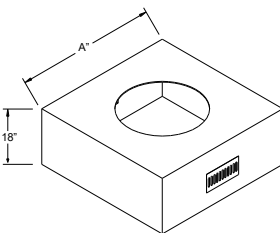

**Size:** 45" X 45", 18" tall  
**Insert:** 25" Bowl Pan, 18" Penta  
**Cladding SQ FT:**  
 Sides: 11.5 - Top: 22.5 - Total: 34  
 Includes 10% Buffer

Ignition	Size (A")	Power	Gas type	Nozzle	Std Model	Max BTU	Nozzle BTU
Electronic Ignition (EI)	45"	120VAC	Natural Gas	TOR	U45S/25SSCEK-NG/120VAC	125k	140k
			Liquid Propane	TOR	U45S/25SSCEK-LP/120VAC		
		24VAC	Natural Gas	TOR	U45S/25SSCEK-NG/24VAC		
			Liquid Propane	TOR	U45S/25SSCEK-LP/24VAC		
Push Button (FPPK)	45"		Natural Gas	TOR	U45S/FPPK25CEK-NG	90k	140k
			Liquid Propane	TOR	U45S/FPPK25CEK-LP		
Match Lit (MLFPK)	45"		Natural Gas	TOR	U45S/MLFPK25CEK-NG	65k	65k
			Liquid Propane	TOR	U45S/MLFPK25CEK-LP		

## RECTANGLE ENCLOSURE - INTERLINK BURNER - SPECIFICATIONS



**EI Models Include:** Enclosure, Fully Assembled Insert, Input Flex Line and Instructions

**FPPK Models Include:** Enclosure, Fully Assembled Insert, Mounting Sleeve and Instructions

**MLFPK Models Include:** Enclosure, Fully Assembled Insert and Instructions

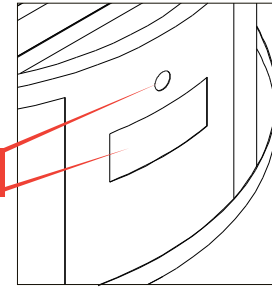

FRAME IS PRE-CUT FOR FPPK OR MLFPK.

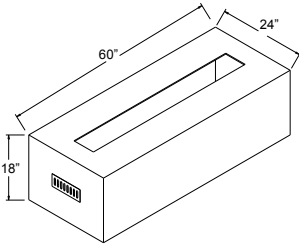

**Size:** 60" X 24", 18" tall  
**Insert:** 37" X 8" Interlink  
**Cladding SQ FT:**  
Side: 22.5 - Top: 8.6 - Total: 31.3  
Includes 10% Buffer

**Size:** 60" X 24", 18" tall  
**Insert:** 49" X 8" Interlink  
**Cladding SQ FT:**  
Side: 22.5 - Top: 8 - Total: 30.5  
Includes 10% Buffer

Ignition	Insert	Power	Gas type	Nozzle	Std Model	Max BTU	Nozzle BTU
Electronic Ignition (EI)	37" X 8"	120VAC	Natural Gas	TOR	U60X24/37X8CEK-NG/120VAC	75k	115k
		24VAC	Liquid Propane	TOR	U60X24/37X8CEK-LP/120VAC		
	49" X 8"	120VAC	Natural Gas	TOR	U60X24/49X8CEK-NG/120VAC	100k	150k
		24VAC	Liquid Propane	TOR	U60X24/49X8CEK-LP/120VAC		
Push Button-Flame Sense (FPPK)	37" X 8"		Natural Gas	TOR	U60X24/37X8FPPKCEK-NG	75k	115k
			Liquid Propane	TOR	U60X24/37X8FPPKCEK-LP		
	49" X 8"		Natural Gas	TOR	U60X24/49X8FPPKCEK-NG	90k	150k
			Liquid Propane	TOR	U60X24/49X8FPPKCEK-LP		
Match Lit (MLFPK)	37" X 8"		Natural Gas	TOR	U60X24/37X8MLFPKCEK-NG	65k	65k
			Liquid Propane	TOR	U60X24/37X8MLFPKCEK-LP		
	49" X 8"		Natural Gas	TOR	U60X24/49X8MLFPKCEK-NG	65k	65k
			Liquid Propane	TOR	U60X24/49X8MLFPKCEK-LP		

## RECTANGLE ENCLOSURE - TROUGH BURNER - SPECIFICATIONS



**EI Models Include:** Enclosure, Fully Assembled Insert, Input Flex Line and Instructions

**FPPK Models Include:** Enclosure, Fully Assembled Insert, Mounting Sleeve and Instructions

**MLFPK Models Include:** Enclosure, Fully Assembled Insert and Instructions

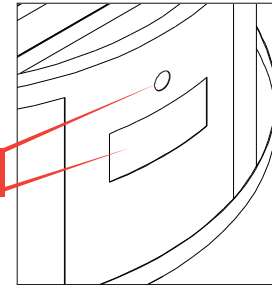

Frame is pre-cut for FPPK or MLFPK.

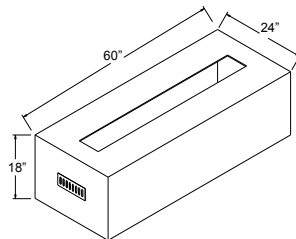

**Size:** 60" X 24", 18" tall  
**Insert:** 36" Trough  
**Cladding SQ FT:**  
Side: 22.5 - Top: 9.2 - Total: 31.7  
Includes 10% Buffer

**Size:** 60" X 24", 18" tall  
**Insert:** " Trough  
**Cladding SQ FT:**  
Side: 22.5 - Top: 8.7 - Total: 31.2  
Includes 10% Buffer

Ignition	Insert	Power	Gas type	Nozzle	Std Model	Max BTU	Nozzle BTU
Electronic Ignition (EI)	36" Trough	120VAC	Natural Gas	TOR	U60X24/36CEK-NG/120VAC	75k	115k
		24VAC	Liquid Propane	TOR	U60X24/36CEK-LP/120VAC		
	48" Trough	120VAC	Natural Gas	TOR	U60X24/48CEK-NG/120VAC	100k	150k
		24VAC	Liquid Propane	TOR	U60X24/48CEK-LP/120VAC		
Push Button-Flame Sense (FPPK)	36" Trough		Natural Gas	TOR	U60X24/36FPPKCEK-NG	75k	115k
			Liquid Propane	TOR	U60X24/36FPPKCEK-LP		
	48" Trough		Natural Gas	TOR	U60X24/48FPPKCEK-NG	90k	150k
			Liquid Propane	TOR	U60X24/48FPPKCEK-LP		
Match Lit (MLFPK)	36" Trough		Natural Gas	TOR	U60X24/36MLFPKCEK-NG	65k	65k
			Liquid Propane	TOR	U60X24/36MLFPKCEK-LP		
	48" Trough		Natural Gas	TOR	U60X24/48MLFPKCEK-NG	65k	65k
			Liquid Propane	TOR	U60X24/48MLFPKCEK-LP		



## RECTANGLE ENCLOSURE - H-BURNER - SPECIFICATIONS



**EI Models Include:** Enclosure, Fully Assembled Insert, Input Flex Line and Instructions

**FPPK Models Include:** Enclosure, Fully Assembled Insert, Mounting Sleeve and Instructions

**MLFPK Models Include:** Enclosure, Fully Assembled Insert and Instructions

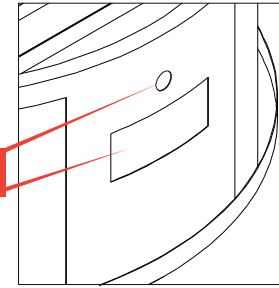

Frame is pre-cut for FPPK or MLFPK.

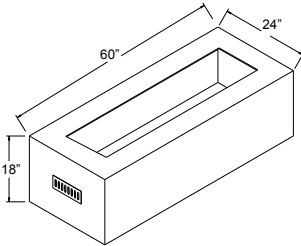

**Size:** 60" X 24", 18" tall  
**Insert:** 30" X 12" H-Burner  
**Cladding SQ FT:**  
 Side: 22.5 - Top: 8.1 - Total: 30.6  
 Includes 10% Buffer

**Size:** 60" X 24", 18" tall  
**Insert:** 36" X 14" H-Burner  
**Cladding SQ FT:**  
 Side: 22.5 - Top: 7 - Total: 29.5  
 Includes 10% Buffer

Ignition	Insert	Power	Gas type	Nozzle	Std Model	Max BTU	Nozzle BTU
Electronic Ignition (EI)	30" X 12"	120VAC	Natural Gas	TOR	U60X24/30X12CEK-NG/120VAC	100k	150k
		24VAC	Liquid Propane	TOR	U60X24/30X12CEK-LP/24VAC		
	36" X 14"	120VAC	Natural Gas	TOR	U60X24/36X14CEK-NG/120VAC	125k	175k
		24VAC	Liquid Propane	TOR	U60X24/36X14CEK-LP/24VAC		
Push Button-Flame Sense (FPPK)	30" X 12"	120VAC	Natural Gas	TOR	U60X24/30X12FPPKCEK-NG	90k	150k
		24VAC	Liquid Propane	TOR	U60X24/30X12FPPKCEK-LP		
Match Lit (MLFPK)	36" X 14"	120VAC	Natural Gas	TOR	U60X24/36X14MLFPKCEK-NG	65k	65k
		24VAC	Liquid Propane	TOR	U60X24/36X14MLFPKCEK-LP		

## RECTANGLE ENCLOSURE - S-FIRE - SPECIFICATIONS



**EI Models Include:** Enclosure, Fully Assembled Insert, Input Flex Line and Instructions

**FPPK Models Include:** Enclosure, Fully Assembled Insert, Mounting Sleeve and Instructions

**MLFPK Models Include:** Enclosure, Fully Assembled Insert and Instructions

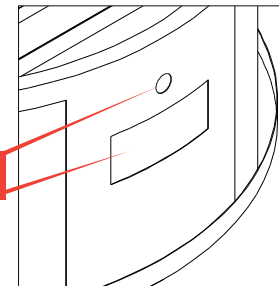

Frame is pre-cut for FPPK or MLFPK.

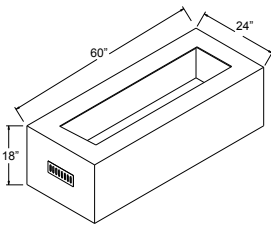

**Size:** 60" X 24", 18" tall  
**Insert:** 36" X 14"  
**Cladding SQ FT:**  
 Side: 22.5 - Top: 7 - Total: 29.5  
 Includes 10% Buffer

Ignition	Size	Power	Gas type	Std Model	Max BTU
Electronic Ignition (EI)	60x24 x18"	120VAC	Natural Gas	U60X24/SFIRECEK-NG/120VAC	75k
		24VAC	Liquid Propane	U60X24/SFIRECEK-LP/24VAC	
Push Button (FPPK)	60x24 x18"		Natural Gas	U60X24/SFIREFPPKCEK-NG	75k
Match Lit (MLFPK)	60x24 x18"		Natural Gas	U60X24/SFIREMLFPKCEK-NG	65k



*CSA Certified*

## SQUARE ENCLOSURE - SMALL TANK - PENTA BURNER - SPECIFICATIONS

**Size:** 54" x 54" diameter, 23.5" tall  
**Insert:** 25" Bowl Pan, 18" Penta

**Cladding SQ FT:**  
Side: 35.5 - Top: 9.5 - Total: 45  
*Includes 10% Buffer*

Ignition	Size (A")	Gas type	Nozzle	Std Model	Max BTU	Nozzle BTU
Push Button - Flame Sense (FPPK)	54"	Liquid Propane	TOR	UST54S/FPPK25CEK-LP	90k	90k
Match Lit (MLFPK)	54"	Liquid Propane	TOR	UST54S/MLFPK25CEK-LP	65k	65k

## ROUND ENCLOSURE - SMALL TANK - PENTA BURNER - SPECIFICATIONS

**Size:** 60" diameter, 23.5" tall  
**Insert:** 25" Bowl Pan, 18" Penta

**Cladding SQ FT:**  
Side: 30.5 - Top: 17.5 - Total: 48  
*Includes 10% Buffer*

Ignition	Size (A")	Gas type	Nozzle	Std Model	Max BTU	Nozzle BTU
Push Button - Flame Sense (FPPK)	60"	Liquid Propane	TOR	UST60R/FPPK25CEK-LP	90k	90k
Match Lit (MLFPK)	60"	Liquid Propane	TOR	UST60R/MLFPK25CEK-LP	65k	65k

## RECTANGLE ENCLOSURE - SMALL TANK - TROUGH BURNER - SPECIFICATIONS

**Size:** 70" x 24" diameter, 23.5" tall  
**Insert:** 36" Trough

**Cladding SQ FT:**  
Side: 30.5 - Top: 11 - Total: 41.5  
*Includes 10% Buffer*

**Size:** 80" x 24" diameter, 23.5" tall  
**Insert:** 48" Trough

**Cladding SQ FT:**  
Side: 34 - Top: 12.5 - Total: 46.5  
*Includes 10% Buffer*

Ignition	Size (A")	Gas type	Nozzle	Std Model	Max BTU	Nozzle BTU
Push Button - Flame Sense (FPPK)	70x24"	Liquid Propane	TOR	UST70X24/36FPPKCEK-LP	90k	90k
Match Lit (MLFPK)	70x24"	Liquid Propane	TOR	UST70X24/36MLFPKCEK-LP	65k	65k
Push Button - Flame Sense (FPPK)	80x24"	Liquid Propane	TOR	UST80X24/48FPPKCEK-LP	90k	90k
Match Lit (MLFPK)	80x24"	Liquid Propane	TOR	UST80X24/48MLFPKCEK-LP	65k	65k

## RECTANGLE ENCLOSURE - SMALL TANK - H-BURNER - SPECIFICATIONS

**Size:** 70" x 24" diameter, 23.5" tall  
**Insert:** 36" x 14" H-Burner

**Cladding SQ FT:**  
Side: 30.5 - Top: 11 - Total: 41.5  
*Includes 10% Buffer*

Ignition	Size (A")	Gas type	Nozzle	Std Model	Max BTU	Nozzle BTU
Push Button - Flame Sense (FPPK)	70x24"	Liquid Propane	TOR	UST70X24/36X14FPPKCEK-LP	90k	90k
Match Lit (MLFPK)	70x24"	Liquid Propane	TOR	UST70X24/36X14MLFPKCEK-LP	65k	65k

## RECTANGLE ENCLOSURE - SMALL TANK - INTERLINK BURNER - SPECIFICATIONS

**Size:** 80" x 24" diameter, 23.5" tall  
**Insert:** 49" x 8" Interlink

**Cladding SQ FT:**  
Side: 34 - Top: 11.5 - Total: 45.5  
*Includes 10% Buffer*

Ignition	Size (A")	Gas type	Nozzle	Std Model	Max BTU	Nozzle BTU
Push Button - Flame Sense (FPPK)	80x24"	Liquid Propane	TOR	UST80X24/49X8FPPKCEK-LP	90k	90k
Match Lit (MLFPK)	80x24"	Liquid Propane	TOR	UST80X24/49X8MLFPKCEK-LP	65k	65k

34 **WARNING: California PROP 65:** This product can expose you to Lead & Chromium, which is known to the State of California to cause cancer and birth defects or other reproductive harm. For more information go to [www.P65Warnings.ca.gov](http://www.P65Warnings.ca.gov).

Inspired by safety. Innovated for your lifestyle.

# TK TORCH

## BACKYARD FIRE EFFECTS THAT WILL WOW ANYONE

Now the backyard can have that resort feeling. How nice it is to have instant "tiki" style fire at your finger tips. No more picking

up fuel; No more filling with messy oils or gel. These torches are state of the art, very robust, reliable, and built to last.



### ACCESSORIES

**FPC-TK TORCH**  
Pg. 48

**940-POSTMOUNT**

**940-POST**

**580**  
Pg. 55

**Features:**

- Burner assembly made of rugged #304 stainless steel for durability.
- Outdoor powder coated post.
- Built for Natural Gas or LP.
- 3-year warranty on hardware; 1-year warranty on gas controls.
- Kano tops available in 2 styles: Hammered Copper or Black Finish
- Available Head Only assembly for column mounting.

### Specifications - Match Lit (MLFPK)

Color	Style	Gas type	Models	Max BTU
Black	Complete with 96" Post	Natural Gas	TK40MAN-B-NG	25k
		Liquid Propane	TK40MAN-B-LP	
	Tiki Top Only	Natural Gas	TKHEAD40MAN-B-NG	25k
		Liquid Propane	TKHEAD40MAN-B-LP	
Copper	Complete with 96" Post	Natural Gas	TK40MAN-C-NG	25k
		Liquid Propane	TK40MAN-C-LP	
	Tiki Top Only	Natural Gas	TKHEAD40MAN-C-NG	25k
		Liquid Propane	TKHEAD40MAN-C-LP	

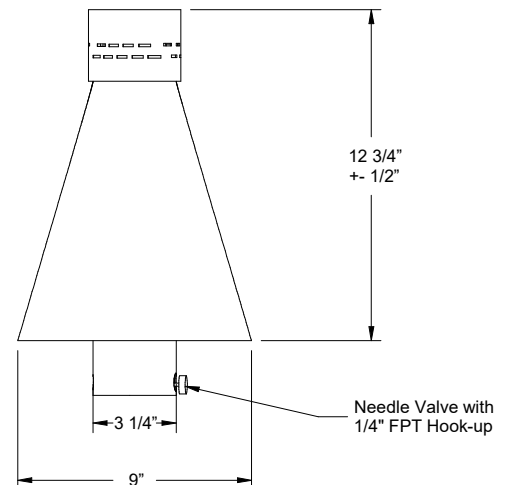

Size: 84" Tall (with 12" underground)  
Burner: TK

# COPPER BOWL SERIES

The HPC Copper Bowl Series is available in the Fire Bowl or the Pool Side Fire & Water Bowl models. Both versions are fitted with a CSA Certified match lit (MLFPK) or remote electronic ignition (EI) fire pit insert and are available with both Liquid Propane or Natural Gas. These come in an oil rubbed look with either a hammered finish or a smooth finish, based on model. The

Pool Side Fire & Water Bowls utilize 1" FIP fitting for pool pump connection.

**SHIPPING:** Both bowl and fire pit insert ship from Ohio warehouse - crate on pallet.

**Fire-and-water models now available in 12V for pool side applications.**



## MESA



Mesa  
Fire Bowl



Mesa Fire  
& Water Bowl

### MESA MODELS - REAL HAMMERED COPPER

This round hammered bowl has an oil-rubbed finish. Includes Access Door.

**Size:** 32" diameter, 15" tall, 15" base  
**Burner:** 12" Penta **Pan:** 18" Flat

**12vac Models** require HPC/SEBCO 12vac, 100W Power Supply for copper ONLY **pg. 58**

### SPECIFICATIONS

Ignition	Bowl Type	Power	Gas type	Nozzle	Std Models	Max BTU	Nozzle BTU
Electronic Ignition (EI)	Fire	120vac	Natural Gas Liquid Propane	TOR	MESA32-EI-NG/120VAC TOR MESA32-EI-LP/120VAC	50k	50k
	Fire	24vac	Natural Gas Liquid Propane	TOR	MESA32-EI-NG/24VAC TOR MESA32-EI-LP/24VAC	50k	50k
	Fire & Water	12vac	Natural Gas Liquid Propane	TOR	MESA32W-EI-NG/12VAC TOR MESA32W-EI-LP/12VAC	50k	50k
Match Lit (MLFPK)	Fire		Natural Gas Liquid Propane	TOR	MESA32-MLFPK-NG TOR MESA32-MLFPK-LP	50k	50k
	Fire & Water		Natural Gas Liquid Propane	TOR	MESA32W-MLFPK-NG TOR MESA32W-MLFPK-LP	50k	50k

# SEDONA



Sedona Fire Bowl

Sedona Fire & Water Bowl

## SEDONA MODELS - REAL HAMMERED COPPER

This square hammered bowl has an oil rubbed finish. Includes Access Door.

**Size:** 40" x 40", 16" tall, 20" x 20" base  
**Burner:** 18" Penta **Pan:** 25" Bowl

**12vac Models** require HPC/SEBCO 12vac, 100W Power Supply for copper ONLY **pg. 58**

### SPECIFICATIONS

Ignition	Bowl Type	Power	Gas type	Nozzle	Std Models	Max BTU	Nozzle BTU
Electronic Ignition (EI)	Fire	120vac	Natural Gas Liquid Propane	TOR	SEDO40-EI-NG/120VAC TOR SEDO40-EI-LP/120VAC	100k	100k
	Fire	24vac	Natural Gas Liquid Propane	TOR	SEDO40-EI-NG/24VAC TOR SEDO40-EI-LP/24VAC	100k	100k
Match Lit (MLFPK)	Fire & Water	12vac	Natural Gas Liquid Propane	TOR	SEDO40W-EI-NG/12VAC TOR SEDO40W-EI-LP/12VAC	100k	100k
	Fire		Natural Gas Liquid Propane	TOR	SEDO40-MLFPK-NG TOR SEDO40-MLFPK-LP	65k	65k
	Fire & Water		Natural Gas Liquid Propane	TOR	SEDO40W-MLFPK-NG TOR SEDO40W-MLFPK-LP	65k	65k

# TEMPE



Tempe Fire Bowl

Tempe Fire & Water Bowl

## TEMPE MODELS - REAL HAMMERED COPPER

This round hammered bowl has an oil rubbed finish. Controls sit below bowl.

**Size:** 31" diameter, 10.5" tall, 10" base  
**Burner:** 12" Penta **Pan:** 19" Bowl

*Tempe - Controls below bowl*

**12vac Models** require HPC/SEBCO 12vac, 100W Power Supply for copper ONLY **pg. 58**

### SPECIFICATIONS

Ignition	Bowl Type	Power	Gas type	Nozzle	Std Models	Max BTU	Nozzle BTU
Electronic Ignition (EI)	Fire	120vac	Natural Gas Liquid Propane	TOR	TEMP31-EI-NG/120VAC TOR TEMP31-EI-LP/120VAC	50k	50k
	Fire	24vac	Natural Gas Liquid Propane	TOR	TEMP31-EI-NG/24VAC TOR TEMP31-EI-LP/24VAC	50k	50k
Match Lit (MLFPK)	Fire & Water	12vac	Natural Gas Liquid Propane	TOR	TEMP31W-EI-NG/12VAC TOR TEMP31W-EI-LP/12VAC	50k	50k
	Fire		Natural Gas Liquid Propane	TOR	TEMP31-MLFPK-NG TOR TEMP31-MLFPK-LP	50k	50k
	Fire & Water		Natural Gas Liquid Propane	TOR	TEMP31W-MLFPK-NG TOR TEMP31W-MLFPK-LP	50k	50k

The HPC Phoenix Copper Bowl model is available in Fire Bowl models only. All three versions are fitted with a CSA Certified match lit (MLFPK), push button flame sensing (FPPK) or remote electronic ignition (EI) fire pit insert and are available with either

Liquid Propane or Natural Gas. These come in an oil rubbed, hand hammered finish that is a beautiful work of art.

**SHIPPING: Both bowl and fire pit insert ship from Ohio warehouse - crate on pallet.**

## SIERRA



### SIERRA MODELS - SMOOTH COPPER FINISH

This square smooth bowl has an oil-rubbed finish. Includes Access Door.

**Size:** 36" x 36", 16" tall, 18" x 18" base  
**Burner:** 12" Penta **Pan:** 19" Bowl

**12vac Models** require HPC/SEBCO 12vac, 100W Power Supply for copper **ONLY** **pg. 58**

### SPECIFICATIONS

Ignition	Bowl Type	Power	Gas type	Nozzle	Std Models	Max BTU	Nozzle BTU
Electronic Ignition	Fire	120vac	Natural Gas	TOR	SIER36-EI-NG/120VAC	50k	50k
			Liquid Propane	TOR	SIER36-EI-LP/120VAC		
	Fire	24vac	Natural Gas	TOR	SIER36-EI-NG/24VAC	50k	50k
			Liquid Propane	TOR	SIER36-EI-LP/24VAC		
	Fire & Water	12vac	Natural Gas	TOR	SIER36W-EI-NG/12VAC	50k	50k
			Liquid Propane	TOR	SIER36W-EI-LP/12VAC		
Match Lit (MLFPK)	Fire		Natural Gas	TOR	SIER36-MLFPK-NG	50k	50k
			Liquid Propane	TOR	SIER36-MLFPK-LP		
	Fire & Water		Natural Gas	TOR	SIER36W-MLFPK-NG	50k	50k
			Liquid Propane	TOR	SIER36W-MLFPK-LP		

## PHOENIX H-BURNER



Phoenix H-Burner

**Size:** 47" Length, 25" Width, 18" tall, 13" base

**Burner:** 30" H-Burner **Pan:** 36" x 14"

### PHOENIX H-BURNER SPECIFICATIONS

Ignition	Bowl Type	Power	Gas type	Nozzle	Std Models	Max BTU	Nozzle BTU
Electronic Ignition (EI)	Fire	120vac	Natural Gas	TOR	PHOEN47X25/HBURN-EI-NG/120VAC	100k	100k
			Liquid Propane	TOR	PHOEN47X25/HBURN-EI-LP/120VAC		
Push Button Flame Sense (FPPK)	Fire		Natural Gas	TOR	PHOEN47X25/HBURN-FPPK-NG	90k	90k
			Liquid Propane	TOR	PHOEN47X25/HBURN-FPPK-LP		
Match Lit (MLFPK)	Fire		Natural Gas	TOR	PHOEN47X25/HBURN-MLFPK-NG	65k	65k
			Liquid Propane	TOR	PHOEN47X25/HBURN-MLFPK-LP		

# PHOENIX S-FIRE



Phoenix S-Fire

Access Door - all models



Convenience Feature - Magnetic Access Door for the Push Button Flame Sense (FPPK) and Match Lit (MLFPPK) models.

**Size:** 47" Length, 25" Width, 18" tall, 13" base  
**Burner:** 30" S-Fire **Pan:** 36" x 14"

## PHOENIX S-FIRE SPECIFICATIONS

Ignition	Bowl Type	Power	Gas type	Models	Max BTU
Electronic Ignition (EI)	Fire	120vac	Natural Gas	PHOEN47X25/SFIRE-EI-NG/120VAC	75k
			Liquid Propane	PHOEN47X25/SFIRE-EI-LP/120VAC	
Push Button Flame Sense (FPPK)	Fire		Natural Gas	PHOEN47X25/SFIRE-FPPK-NG	75k
			Liquid Propane	PHOEN47X25/SFIRE-FPPK-LP	
Match Lit (MLFPPK)	Fire		Natural Gas	PHOEN47X25/SFIRE-MLFPPK-NG	65k
			Liquid Propane	PHOEN47X25/SFIRE-MLFPPK-LP	

# PHOENIX TROUGH



Phoenix Trough

All Phoenix models come Ventilated



**Size:** 47" Length, 25" Width, 18" tall, 13" base  
**Burner:** 36" Linear Burner Trough  
**Pan:** 36" Trough

## PHOENIX TROUGH SPECIFICATIONS

Ignition	Bowl Type	Power	Gas type	Nozzle	Std Models	Max BTU	Nozzle BTU
Electronic Ignition (EI)	Fire	120vac	Natural Gas	TOR	PHOEN47X25/TRGH-EI-NG/120VAC	75k	75k
			Liquid Propane	TOR	PHOEN47X25/TRGH-EI-LP/120VAC		
Push Button Flame Sense (FPPK)	Fire		Natural Gas	TOR	PHOEN47X25/TRGH-FPPK-NG	75k	75k
			Liquid Propane	TOR	PHOEN47X25/TRGH-FPPK-LP		
Match Lit (MLFPPK)	Fire		Natural Gas	TOR	PHOEN47X25/TRGH-MLFPPK-NG	65k	65k
			Liquid Propane	TOR	PHOEN47X25/TRGH-MLFPPK-LP		

The HPC Sport Pit Series is a camper's, tailgaters, and backyard hangers dream. With a lid that spins on with the twist of a wrist keeping the glass media in place and providing a handle for easy

transport its the fire pit for anyone on the go. There is a quick LP Tank hookup that allows for easy setup and teardown so you never miss a moment.



*CSA Certified*



## SPORT PIT - EASY TO TRANSPORT FIRE PIT

This Portable Fire Pit has the ability for the lid to spin on for easy transportation.

- Burntime with a 20lb tank is 13 hours
- Tip over swich insures safety
- Thermocouple for flame recognition
- Built in Regulator with 13 foot hose

**Size:** 20", 13" tall  
**Burner:** 10" Round

## MATCH LIT UNITS

Type	Gas type	Models (EI)	Max BTU
Large	Liquid Propane	SPORTPIT20-BLK	37k



Sport Pit Mini  
Coming Soon





## EVOLUTION 360

These inserts have many unique and user friendly features that make them a year round water and fire pits. We have made these inserts so the fire, water and lighting features will work

independently of each other making them ideal in areas that require the water feature to be winterize. **Ships in crate on pallet.**

### HAMMERED COPPER FIRE BOWL

Hammered Copper - 4 Scupper



360 Feature being finished with paver stone  
Includes Basin, 26" Copper Water Bowl, and Electronic Ignition Fire Pit (13SSEI).

Hammered Copper - 360



Winner of two Vesta Awards for Product Innovation and Design



Four Scupper Feature



360 Feature

### SPECIFICATIONS - ELECTRONIC IGNITION (EI)

Bowl Type	Power	Gas type	Models (EI)	Max BTU
4 Scupper	120vac	Natural Gas	WB52R-TEMP4-EI-NG	90k
		Liquid Propane	WB52R-TEMP4-EI-LP	
360	120vac	Natural Gas	WB52R-TEMP360-EI-NG	90k
		Liquid Propane	WB52R-TEMP360-EI-LP	

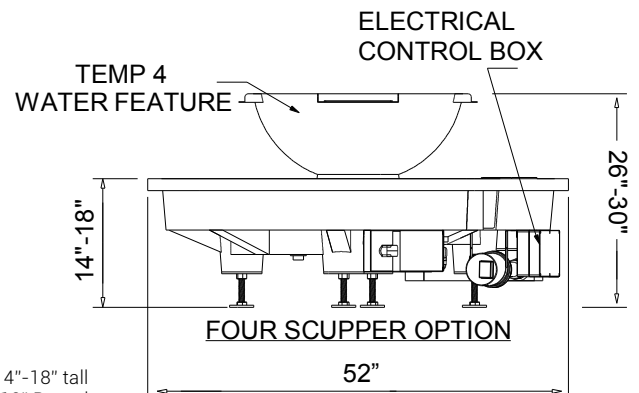

Size: 52" diameter, 14"-18" tall  
Burner: 12" Round

## H2Onfire



A true electronic fire on water, turn-key appliance operating at a gas pressure less than 1/4 psi, allowing for residential installations. It is also the first "fire on water" system to be certified in North America to the Z21.97 standard by the CSA Group - passing the stringent wind, rain, and combustion test.

The fire ring is totally submerged underwater using our patent pending burner design and back flow prevention to protect the controls - giving an even and very appealing flame at only 65,000 Btu. This is NOT a match lit system- it is remote control with auto relight. Our ignition and flame sensing network is located in the center tower monitoring flame conditions at all times. **Ships in crate on pallet.**

### CONCRETE FIRE ON WATER AND HAMMERED COPPER 360

Black Concrete Bowl - 4 Scupper

Burnt Sienna Concrete Bowl - 4 Scupper



Hammered Copper Fire on Water - 360

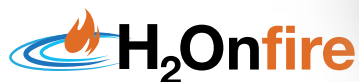

Fully Assembled. Includes Basin, Water Bowl, and Fire on Water Control System



578-G4  
Optional Remote Available



Winner of Vesta Awards Finalist

### SPECIFICATIONS - ELECTRONIC IGNITION (EI)

Color	Bowl Type	Power	Gas type	Models	Max BTU
Concrete Burnt Sienna	4 Scupper	120vac	Natural Gas Liquid Propane	FW52R-MONACO4BS-EI-NG FW52R-MONACO4BS-EI-LP	65k
Concrete Black	4 Scupper	120vac	Natural Gas Liquid Propane	FW52R-MONACO4BL-EI-NG FW52R-MONACO4BL-EI-LP	65k
Copper - Hammered	360	120vac	Natural Gas Liquid Propane	FW52R-CYPRUS360-EI-NG FW52R-CYPRUS360-EI-LP	65k

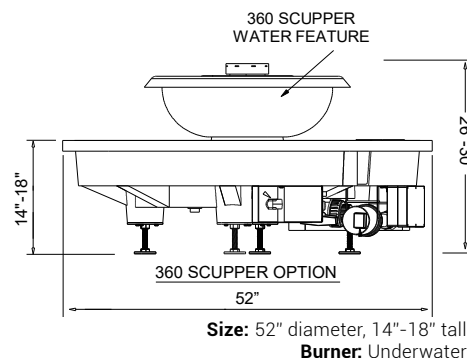

# FIRE LOGS

## CONCRETE OUTDOOR LOGS

Second only to the flame itself, nothing says outdoor fire pit like a beautiful set of fire logs. HPC is introducing a new line of fire logs this year. This new line-up features logs that are intricately detailed and

extremely durable. To give our logs a true realistic appearance, they are actually cast from real pieces of wood. Nearly impossible to tell from the real thing! Three distinctive styles, in 9-piece or 16-piece sets.



### ARIZONA WEATHERED OAK

A classic look. The Arizona Weathered Oak fire log set features deeply contoured bark, all intricately hand-painted. Beautiful from every angle.

#### SPECIFICATIONS

Style	Model	Piece	Size
Arizona	FPL18/24AW09	9	12"-18"
Weathered Oak	FPL30/36AW016	16	14"-18"



### ASPEN BIRCH

Logs with a contemporary flair, these Aspen Birch fire logs fit very well with rectangular and linear fire pits.

#### SPECIFICATIONS

Style	Model	Piece	Size
Aspen	FPL18/24AB9	9	11"-18"
Birch	FPL30/36AB16	16	13"-18"



### WESTERN DRIFTWOOD

A new design, the Western Driftwood fire log set really looks like its pieces were picked up off the beach. Beautiful whether the fire is burning or not.

#### SPECIFICATIONS

Style	Model	Piece	Size
Western	FPL18/24WD9	9	10"-18"
Driftwood	FPL30/36WD16	16	10"-21"

## LAVA & CERAMIC ROCK

### LAVA ROCK



Time tested, Lava Rock is proven to increase combustion efficiency while maintaining a classy look for any fire pit. The size of each piece of rock varies from 1" to 2". Lava rock is sold in 1/2 cubic foot increments. Serves as an excellent base for our specially designed outdoor logs.

Model	Size
657	1"-2" Size

### ROLLED LAVA STONE



Unique finish lava stone rolled smooth. Available in 1/2 cubic foot bags.

Color	Model	Size
Black	857S	1"-2" Size
	857M	2.5"-4.5" Size

### CERAMIC RIVER ROCK SERIES

Looking for something other than lava rock or glass? HPC has a third option for media over your outdoor (or indoor) burner, our River Rock Series. These imitation stones are lightweight ceramic fiber, gel cast and designed to take on the outdoor elements. Each set comes with an 84 piece assortment of large and small stones (large pieces are 4 1/2", small pieces are 2 1/2"). One set is 1/2 cubic foot (15 lbs). Available in two styles – black or multi color (light and dark brown, gray, and black)



Model	Color	Size
FPR84MC	Multicolor	2.5" - 4.5" Size
FPR84BL	Black	2.5" - 4.5" Size

# FIRE GLASS

HPC has 10 colors to choose from - The glass shown- is 1/4"

Sold in 10 lb increments (Priced per 10lbs)



**NEED HELP? CHECK OUT OUR GLASS CALCULATOR AT [HPCFIRE.COM](http://HPCFIRE.COM)!**

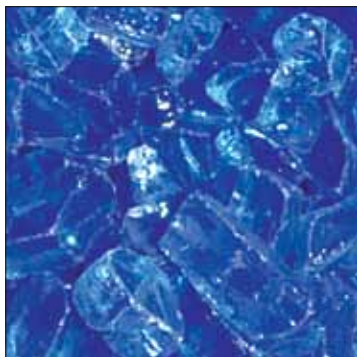

FPGLCOBALTBLUE



FPGLPACIFICBLUE

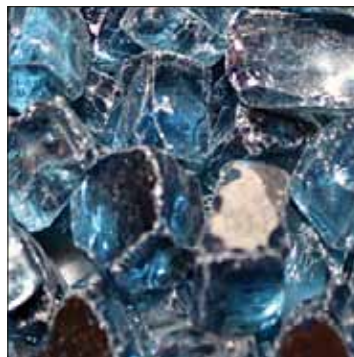

FPGLPACBLUEREF

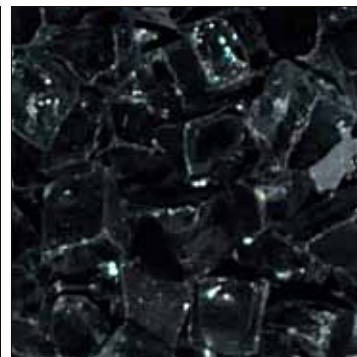

FPGLBLACK



FPGLCLEAR



FPGLSTARFIRE



FPGLGRAYREFLEC



FPGLCOPPER

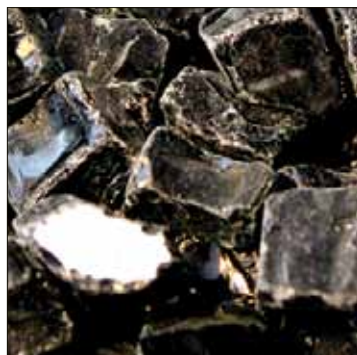

FPGLBLACKREFL



FPGLBRONZE

## GLASS WIND GUARDS

HPC provides a high quality glass wind guard specially designed to complement as well as provide additional safety for HPC fire pit inserts of all shapes- round, square, rectangle and linear. These feature a durable tempered glass construction to ensure a long lasting, heat

resistant product. Wind guards reduce flame disturbance of your fire pit and prevent loose items from getting too close to the flames.

### Features:

**Tempered Glass** - Heavy duty 3/16" clear glass is tempered to improve durability and allow it to withstand high temperatures. Depending on wind guard size- 4 or 6 sections complete the desired shape.

**Brackets**- Polished aluminum brackets and plastic support feet provided.



Round Wind Guard



Square Wind Guard



Rectangle Wind Guard



Linear Wind Guard

### Specifications

Shape	Size	Model	Height
Round	23"	WG23-RD	6"
	30"	WG30-RD	6"
	38"	WG38-RD (6 Pieces)	6"
	48"	WG48-RD (6 Pieces)	6"
Square	25x25"	WG25-SQ	6"
	31x31"	WG31-SQ	6"
	37x37"	WG37-SQ	6"
	43x43"	WG43-SQ	6"
	49x49"	WG49-SQ	6"
Rectangle	31x19"	WG31X19-RECT	6"
	37x19"	WG37X19-RECT	6"
	43x21"	WG43X21-RECT	6"
	49x21"	WG49X21-RECT	6"
	61x23"	WG61X23-RECT	6"
	Linear	31X15"	WG31X15-L
43X15"		WG43X15-L	6"
55X15"		WG55X15-L	6"
67X15"		WG67X15-L	6"

### WIND GUARD REPLACEMENT CLIPS

Replacement clips for HPC Wind Guards (one clip per pack). Please note if needing a bottom clip, will need rubber foot, also found below.

Model	Description
WG-CC-RD	Replacement chrome clip for round wind guards
WG-CC-SQ/RECT	Replacement Chrome Corner Clip For Square & Rectangle Wind Guards

### WIND GUARD REPLACEMENT RUBBER FEET

Replacement rubber feet for HPC Wind Guards (one foot per pack).

Model	Description
WG-RUBBER FOOT-RD	Replacement rubber foot for round wind guards
WG-RUBBER FOOT-SQ/RECT	Replacement rubber foot for square & rectangle wind guards



WG-SC



WG-RUBBER FOOT-SQ/RECT



WG-EGS



WG-CC-SQ/RECT

### WIND GUARD EXTENSION KIT AND PARTS

The WG-EXT/STR KIT allows you to combine rectangle, linear and square HPC wind guards.

Model	Description
WG-EXT/STR KIT	Complete Kit - 4 Extension chrome straight clips and 4 extension glass supports with rubber foot
WG-SC	Replacement extension chrome straight clip for square & linear wind guards-used for extending lengths on glass panels
WG-EGS	Replacement extension glass support with rubber foot

WG-EXT/STR KIT



WG-EXT/STR KIT installed

# FIRE PIT COVERS

## ROUND ALUMINUM COVERS - TALL

These lightweight aluminum hard covers are powder coated with UV resistant, high-heat textured black or gloss copper. They are available in two sizes - 32" (15lbs) and 44" (20lbs).

Color	Size	Models	Height	Weight
Copper Vein	32"	FPHC-32C	10"	15 lbs
	44"	FPHC-44C	14"	20 lbs
Black	32"	FPHC-32BL	10"	15 lbs
	44"	FPHC-44BL	14"	20 lbs



## ROUND ALUMINUM COVERS - SHORT



Color	Size	Models	Height	Weight
Copper Vein	24"	FPHC-24C	1"	6 lbs
	36"	FPHC-36C	1"	13 lbs
	48"	FPHC-48C	1"	23.5 lbs
Black	24"	FPHC-24BL	1"	6 lbs
	36"	FPHC-36BL	1"	13 lbs
	48"	FPHC-48BL	1"	23.5 lbs

## COPPER COVERS FOR COPPER BOWLS

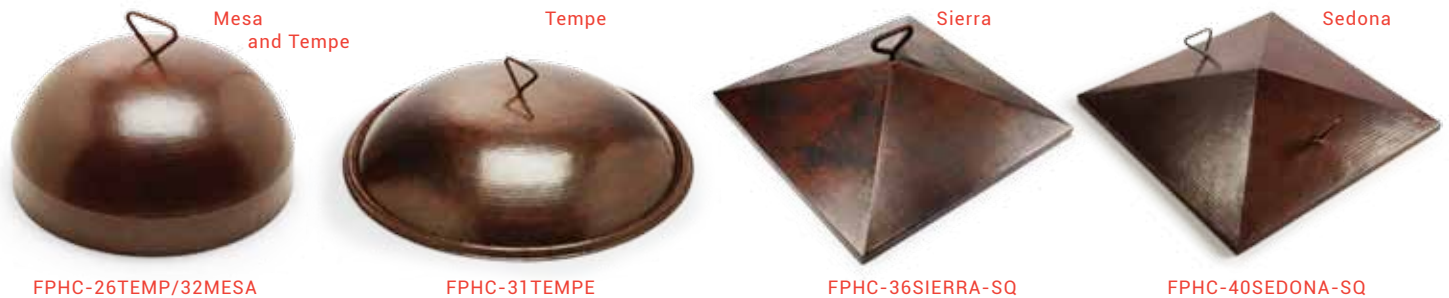

Shape	Finish	Models	Size	Height	Weight
Round	Hammered	FPHC-26TEMP/32MESA	19"	8.5"	7.5 lbs
	Hammered	FPHC-31TEMPE	32"	5.75"	15 lbs
Square	Smooth	FPHC-36SIERRA-SQ	26"X26"	7"	13 lbs
	Hammered	FPHC-40SEDONA-SQ	30"X30"	7"	13.5 lbs

## STAINLESS STEEL COVERS

These stainless steel covers are constructed of #304, 20 gauge material with handle. Great for covering fire pits without outdoor logs. Linear trough covers are designed specifically for our trough series, be it match

lit, manual ignition, or remote electronic ignition models. These are lightweight and have handles for ease of use.

### LINEAR

Stainless	Size	Model	Height	Handle	Weight
Brushed	28" x 9.5"	TPHC-24SS	1"	1	11 lbs
	40" x 9.5"	TPHC-36SS	1"	1	13 lbs
	52" x 9.5"	TPHC-48SS	1"	2	15 lbs
	64" x 9.5"	TPHC-60SS	1"	2	18lbs

### RECTANGLE

Stainless	Size	Model	Height	Handle	Weight
Brushed	28" x 16"	HPHC-24X12SS	1"	1	16 lbs
	34" x 16"	HPHC-30X12SS	1"	1	18 lbs
	40" x 18"	HPHC-36X14SS	1"	1	20 lbs
	46" x 18"	HPHC-42X14SS	1"	2	22 lbs
	58" x 20"	HPHC-54X16SS	1"	2	28 lbs



# ACCESSORIES

## VINYL COVERS

Made of durable vinyl, these cover and protect a fire pit and enclosure from debris and wet weather. The round covers have elastic and

rectangle covers have a pull string at the bottom for ease of applying and removal. **NOTE: Skirt Length 10"**

### ROUND COVERS

Max Size	Models	Fits Enclosures
35"	FPC-35	23" ~ 35"
45"	FPC-45	30" ~ 45"
53"	FPC-53	35" ~ 53"
64"	FPC-64	43" ~ 64"
76"	FPC-76	60" ~ 76"

### GREY ROUND COVERS

Max Size	Models	Fits Enclosures
53" x 53"	FPC-53-GR	35" ~ 53"



### SQUARE COVERS

Max Size	Models	Fits Enclosures
48" x 48"	FPC-48SQ	36" ~ 48"
60" x 60"	FPC-60SQ	45" ~ 60"

### GREY SQUARE COVERS

Max Size	Models	Fits Enclosures
60" x 60"	FPC-60SQ-GR	45" ~ 60"



### RECTANGLE COVERS

Max Size	Models	Fits Enclosures
48" x 30"	FPC-44X30	34x20" ~ 44x30"
62" x 30"	FPC-62X30	52x20" ~ 62x30"
78" x 40"	FPC-78X40	68x30" ~ 78x40"
90" x 40"	FPC-90X40	80x30" ~ 90x40"
94" x 30"	FPC-94X30	84x20" ~ 94x30"
102" x 40"	FPC-102X40	92x30" ~ 102x40"
114" x 40"	FPC-114X40	104x30" ~ 114x40"
130" x 30"	FPC-130X30	120x20" ~ 130x30"

### GREY SQUARE COVERS

Max Size	Models	Fits Enclosures
78" x 40"	FPC-78X40-GR	45" ~ 60"



### EVOLUTION 360 AND H2ONFIRE COVERS

Model	Style
FPC-84WB	Basin
FPC-35	Bowl



### TK TORCH COVER - (FPC-TK TORCH)

TK Torch Cover w/Elastic Hem  
(3.5" Top Dia x 9.5" Bottom Dia. x 14" Height)



### STAINLESS STEEL ACCESS DOORS

Stainless steel access doors are available for all FPPK and MLFPK Hard pipe Models.

Model	Style
AD-RM6X6SS	6x6 Recess Mount
AD-RM8X8SS	8x8 Recess Mount
AD-SM8X8SS	8x8 Surface Mount



Recess Mount

Surface Mount

### ENCLOSURE VENTS

Stainless Steel vents for enclosures.

Material	Style	Size	Model
Stainless	Flat	9"x4"	EV-8X4SS
	Flat	12"x6"	EV-12X6SS
	Louvered	14"x4.5"	EV-14X4.5SS



Flat

Louvered



**DECK INSTALLATION KIT (EI, FPPK & MLFPK)**

This kit is for use when installing a gas fire pit on a wood or composite deck- provides flame and excess heat protection around input flex line connection(s). This basalt insulation is for inside the fire pit enclosure or bowl, is meant to place over a layer of paver blocks (1" min. thickness) commonly found at your local builder's store. Incoming gas stub must protrude through the deck, paver blocks and insulation for fire pit flex

line connection. Kit includes basalt insulation and instructions- basalt insulation measures 39.3" x 39.3" (1 sq. meter)- larger fire pits will require more pieces, insulation is easily cut with utility knife. Smaller bowl kit available.

**FPI-DECK20SQ** - For fire bowls- includes basalt insulation- 19.6" x 19.6"

**FPI-DECK39SQ** - For fire pits- includes basalt insulation- 39.3" x 39.3" (1 sq. meter).

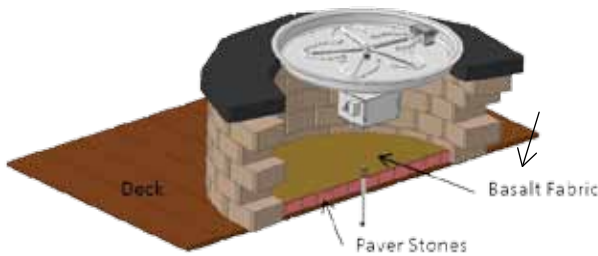

**MATCH LIT MODELS (MLFPK) PAVER BLOCK BRACKET**

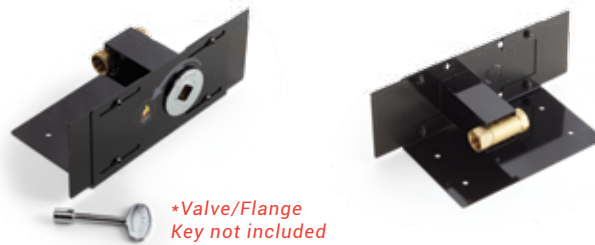

\*Valve/Flange Key not included

**KVMB-PB**

Designed for the Dante Valve, this bracket allows flexibility and installation ease of the MLFPK decorative key valve. The face plate is adjustable from 8" to 12" width accommodating most pavers. The valve is securely mounted to bracket using decorative flange. (8-12"W x 3.875H x 5"D)

**IMPORTANT:** For use only with DANTE Valve #327-CH (Pg. 57)

**REPLACEMENT REMOTE SMALL TANK KIT - LP (FPPK & MLFPK)**

**STLPK**

This kit is for use with CSA certified FPPK and MLFPK fire pit models less than 90k Btu- see fire pit insert section for approved models. The kits includes a 90-degree regulator with 48" hose, 24" Flex Line, small tank L-Bracket and fittings for FPPK or MLFPK connection.

For use with CSA Certified FPPK & MLFPK fire pit inserts only



**MATCH LIT SPARK IGNITER KIT**

**SIK36**

Can't find matches or a lighter for a match-lit fire pit? No problem! HPC now offers a "Match-Lit Plus" Spark Ignitor Kit, which is easily installed and makes any match-lit fire pit much more convenient to light. Included in the kit is the spark ignitor itself, plus the battery-activated push-button mounting plate (battery included).



# ACCESSORIES

## HARDSCAPE BLOCK KIT

This kit is for use when installing a fire pit in ready-made hardscape blocks. The kit includes all the things you'll need to complete the installation.

### Kit Includes

- Fire Pit Insert
- Flex Form Collars (1 or 2 Boxes) (44x6.2")
- Vents - 2 (4x4")
- SSC24 Flex Line (24")
- Lava Rock



	Pan Size	Gas type	Nozzle	Std Model	Insert Details
FPPK ROUND FLAT	14"	Natural Gas Liquid Propane		BLOCK-FPPK14-FLEX-NG BLOCK-FPPK14-FLEX-LP	Round Flat Round Flat
	18"	Natural Gas Liquid Propane	TOR- TOR-	BLOCK-PENTA18FPPK-FLEX-NG BLOCK-PENTA18FPPK-FLEX-LP	Round Flat Round Flat
	24"	Natural Gas Liquid Propane	TOR- TOR-	BLOCK-PENTA24FPPK-FLEX-NG BLOCK-PENTA24FPPK-FLEX-LP	Round Flat Round Flat
	30"	Natural Gas Liquid Propane	TOR- TOR-	BLOCK-PENTA30FPPK-FLEX-NG BLOCK-PENTA30FPPK-FLEX-LP	Round Flat Round Flat
	36"	Natural Gas Liquid Propane	TOR- TOR-	BLOCK-PENTA36FPPK-FLEX-NG BLOCK-PENTA36FPPK-FLEX-LP	Round Flat Round Flat
MLFPPK ROUND FLAT	8"	Natural Gas Liquid Propane		BLOCK- MLFPPK8-FLEX-NG BLOCK-MLFPPK8-FLEX-LP	Round Flat Round Flat
	14"	Natural Gas Liquid Propane	TOR- TOR-	BLOCK-PENTA14 MLFPPK-FLEX-NG BLOCK-PENTA14 MLFPPK-FLEX-LP	Round Flat Round Flat
	18"	Natural Gas Liquid Propane	TOR- TOR-	BLOCK-PENTA18 MLFPPK-FLEX-NG BLOCK-PENTA18 MLFPPK-FLEX-LP	Round Flat Round Flat
	24"	Natural Gas Liquid Propane	TOR- TOR-	BLOCK-PENTA24 MLFPPK-FLEX-NG BLOCK-PENTA24 MLFPPK-FLEX-LP	Round Flat Round Flat
	30"	Natural Gas Liquid Propane	TOR- TOR-	BLOCK-PENTA30 MLFPPK-FLEX-NG BLOCK-PENTA30 MLFPPK-FLEX-LP	Round Flat Round Flat
FPPK ROUND SQUARE	18"	Natural Gas Liquid Propane	TOR- TOR-	BLOCK-FPPK18-SQ-FLEX-NG BLOCK-FPPK18-SQ-FLEX-LP	Square Flat Square Flat
	24"	Natural Gas Liquid Propane	TOR- TOR-	BLOCK-FPPK24-SQ-FLEX-NG BLOCK-FPPK24-SQ-FLEX-LP	Square Flat Square Flat
	30"	Natural Gas Liquid Propane	TOR- TOR-	BLOCK-FPPK30-SQ-FLEX-NG BLOCK-FPPK30-SQ-FLEX-LP	Square Flat Square Flat
	36"	Natural Gas Liquid Propane	TOR- TOR-	BLOCK-FPPK36-SQ-FLEX-NG BLOCK-FPPK36-SQ-FLEX-LP	Square Flat Square Flat
MLFPPK FLAT SQ	18"	Natural Gas Liquid Propane	TOR- TOR-	BLOCK-MLFPPK18SQ-FLEX-NG BLOCK-MLFPPK18SQ-FLEX-LP	Square Flat Square Flat
	24"	Natural Gas Liquid Propane	TOR- TOR-	BLOCK-MLFPPK24SQ-FLEX-NG BLOCK-MLFPPK24SQ-FLEX-LP	Square Flat Square Flat
	30"	Natural Gas Liquid Propane	TOR- TOR-	BLOCK-MLFPPK30SQ-FLEX-NG BLOCK-MLFPPK30SQ-FLEX-LP	Square Flat Square Flat



## HARDSCAPE BLOCK KIT

This kit is for use when installing a fire pit in ready-made hardscape blocks. The kit includes all the things you'll need to complete the installation.

### Kit Includes

- Fire Pit Insert
- Flex Form Collars (1 or 2 Boxes) (44x6.2")
- Vents - 2 (4x4")
- SSC24 Flex Line (24")
- Lava Rock



	Pan Size	Gas type	Nozzle	Std Model	Insert Details
FPPK H-BURNER	24x12"	Natural Gas	TOR-	BLOCK-FPPK24X12-H-FLEX-NG	H-Burner
		Liquid Propane	TOR-	BLOCK-FPPK24X12-H-FLEX-LP	H-Burner
	30x12"	Natural Gas	TOR-	BLOCK-FPPK30X12-H-FLEX-NG	H-Burner
		Liquid Propane	TOR-	BLOCK-FPPK30X12-H-FLEX-LP	H-Burner
	36x14"	Natural Gas	TOR-	BLOCK-FPPK36X14-H-FLEX-NG	H-Burner
Liquid Propane	TOR-	BLOCK-FPPK36X14-H-FLEX-LP	H-Burner		
42x14"	Natural Gas	TOR-	BLOCK-FPPK42X14-H-FLEX-NG	H-Burner	
	Liquid Propane	TOR-	BLOCK-FPPK42X14-H-FLEX-LP	H-Burner	
54x16"	Natural Gas	TOR-	BLOCK-FPPK54X16-H-FLEX-NG	H-Burner	
	Liquid Propane	TOR-	BLOCK-FPPK54X16-H-FLEX-LP	H-Burner	
MLFPPK H-BURNER	24x12"	Natural Gas	TOR-	BLOCK-MLFPPK24X12-H-FLEX-NG	H-Burner
		Liquid Propane	TOR-	BLOCK-MLFPPK24X12-H-FLEX-LP	H-Burner
	30x12"	Natural Gas	TOR-	BLOCK-MLFPPK30X12-H-FLEX-NG	H-Burner
Liquid Propane	TOR-	BLOCK-MLFPPK30X12-H-FLEX-LP	H-Burner		
36x14"	Natural Gas	TOR-	BLOCK-MLFPPK36X14-H-FLEX-NG	H-Burner	
Liquid Propane	TOR-	BLOCK-MLFPPK36X14-H-FLEX-LP	H-Burner		
FPPK INTERLINK	25x8"	Natural Gas	TOR-	BLOCK-FPPK25X8-L-FLEX-NG	Interlink
	Liquid Propane	TOR-	BLOCK-FPPK25X8-L-FLEX-LP	Interlink	
	37x8"	Natural Gas	TOR-	BLOCK-FPPK37X8-L-FLEX-NG	Interlink
	Liquid Propane	TOR-	BLOCK-FPPK37X8-L-FLEX-LP	Interlink	
	49x8"	Natural Gas	TOR-	BLOCK-FPPK49X8-L-FLEX-NG	Interlink
	Liquid Propane	TOR-	BLOCK-FPPK49X8-L-FLEX-LP	Interlink	
	61x8"	Natural Gas	TOR-	BLOCK-FPPK61X8-L-FLEX-NG	Interlink
Liquid Propane	TOR-	BLOCK-FPPK61X8-L-FLEX-LP	Interlink		
MLFPPK INTERLINK	25x8"	Natural Gas	TOR-	BLOCK-MLFPPK25X8-L-FLEX-NG	Interlink
	Liquid Propane	TOR-	BLOCK-MLFPPK25X8-L-FLEX-LP	Interlink	
	37x8"	Natural Gas	TOR-	BLOCK-MLFPPK37X8-L-FLEX-NG	Interlink
Liquid Propane	TOR-	BLOCK-MLFPPK37X8-L-FLEX-LP	Interlink		
49x8"	Natural Gas	TOR-	BLOCK-MLFPPK49X8-L-FLEX-NG	Interlink	
	Liquid Propane	TOR-	BLOCK-MLFPPK49X8-L-FLEX-LP	Interlink	

## FLEX FORM INSTALLATION COLLARS

The flex form install collar merges the gap between the fire pit structure and the insert pan for easy installation and auto centering featured with a curved lip. This flexible install collar allows for an easy 3 step installation saving you time with our one size fits all product. The collar can be formed to fit any shaped fire pit.

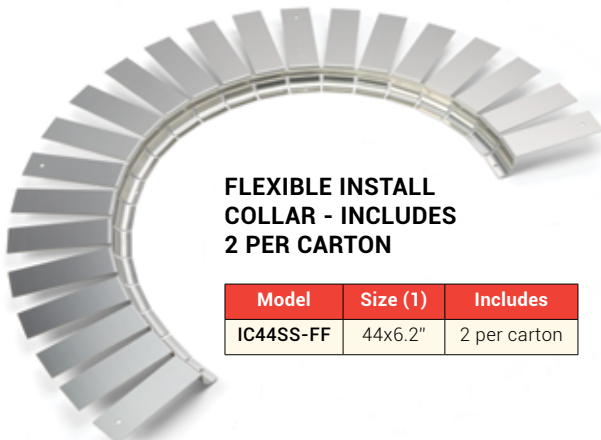

**FLEXIBLE INSTALL COLLAR - INCLUDES 2 PER CARTON**

Model	Size (1)	Includes
IC44SS-FF	44x6.2"	2 per carton

### Step 1



Place the collar

### Step 2



Install the collar

### Step 3



Install the insert

## FIRE PIT KIT (FPS SERIES)

Includes everything needed to put together a match lit fire pit. Includes burner, a valve with polished chrome flange, flex line and fittings.



## PENTA BURNER KITS- STAINLESS STEEL (#304)

Size	Gas Type	Nozzle	Model	Hub Size	Btu	Nozzle BTU	Valve Size	Flex Line
12"	Natural Gas	TOR	FPS/PENTA12 KIT	1/2"	65k	100k	1/2"	18"
	Liquid Propane	TOR	FPS/PENTA12LP KIT					
18"	Natural Gas	TOR	FPS/PENTA18 KIT	1/2"	125k	175k	1/2"	18"
	Liquid Propane	TOR	FPS/PENTA18LP KIT					
24"	Natural Gas	TOR	FPS/PENTA24 KIT	1/2"	200k	250k	1/2"	18"
	Liquid Propane	TOR	FPS/PENTA24LP KIT					
30"	Natural Gas	TOR	FPS/PENTA30 KIT	3/4"	250k	300k	3/4"	24"
	Liquid Propane	TOR	FPS/PENTA30LP KIT					
36"	Natural Gas	TOR	FPS/PENTA36 KIT	3/4"	300k	350k	3/4"	24"
	Liquid Propane	TOR	FPS/PENTA36LP KIT					
48"	Natural Gas	TOR	FPS/PENTA48 KIT	3/4"	300k	350k	3/4"	24"
	Liquid Propane	TOR	FPS/PENTA48LP KIT					

Penta Burner



**Features:**

Burner Ports - 9 and 3 o'clock  
Raised Hub Design  
Patented Technology

## ROUND BURNER KITS- STAINLESS STEEL (#304)

Size	Gas Type	Model	Hub Size	Btu	Valve Size	Flex Line
6"	Natural Gas	FPS6 KIT	1/2"	60k	1/2"	18"
	Liquid Propane	FPS6LP KIT				
12"	Natural Gas	FPS12 KIT	1/2"	90k	1/2"	18"
	Liquid Propane	FPS12LP KIT				
18"	Natural Gas	FPS18 KIT	1/2"	150k	1/2"	18"
	Liquid Propane	FPS18LP KIT				
24"	Natural Gas	FPS24 KIT	1/2"	150k	1/2"	18"
	Liquid Propane	FPS24LP KIT				
24" (HC)	Natural Gas	FPS24HC KIT	3/4"	300k	3/4"	18"
	Liquid Propane	FPS24HCLP KIT				
30"	Natural Gas	FPS30 KIT	1/2"	300k	1/2"	24"
	Liquid Propane	FPS30LP KIT				
30" (HC)	Natural Gas	FPS30HC KIT	3/4"	300k	3/4"	24"
	Liquid Propane	FPS30HCLP KIT				
36"	Natural Gas	FPS36HC KIT	3/4"	300k	3/4"	24"
	Liquid Propane	FPS36HCLP KIT				
48"	Natural Gas	FPS48HC KIT	3/4"	300k	3/4"	24"
	Liquid Propane	FPS48HCLP KIT				

**Features:**

Burner Ports - Staggered  
Raised Hub Design

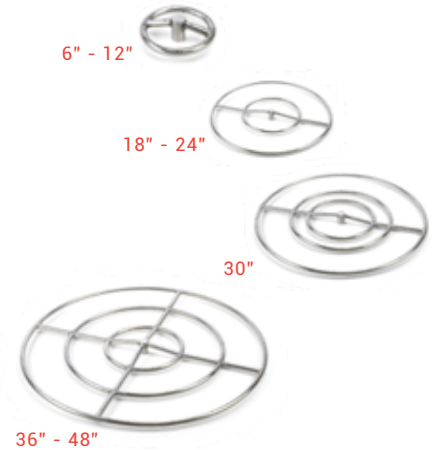

## SQUARE BURNER KITS- STAINLESS STEEL (#304)

Size	Gas Type	Model	Hub Size	Btu	Valve Size	Flex Line
12"	Natural Gas	FPSSQ12 KIT	1/2"	90k	1/2"	18"
	Liquid Propane	FPSSQ12LP KIT				
18"	Natural Gas	FPSSQ18 KIT	1/2"	150k	1/2"	18"
	Liquid Propane	FPSSQ18LP KIT				
24"	Natural Gas	FPSSQ24 KIT	1/2"	150k	1/2"	18"
	Liquid Propane	FPSSQ24LP KIT				
36"	Natural Gas	FPSSQ36HC KIT	3/4"	300k	3/4"	24"
	Liquid Propane	FPSSQ36HCLP KIT				
48"	Natural Gas	FPSSQ48HC KIT	3/4"	300k	3/4"	24"
	Liquid Propane	FPSSQ48HCLP KIT				

**Features:**

Burner Ports - Staggered  
Raised Hub Design

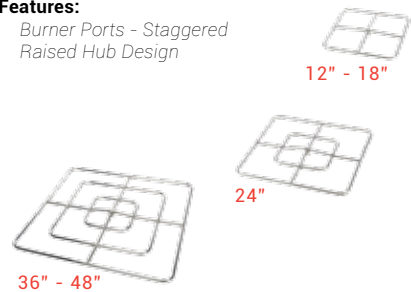

## FIRE PIT KIT (FPS SERIES)

Includes everything needed to put together a match lit fire pit. Includes burner, a valve with polished chrome flange, flex line and fittings.

### RECTANGLE BURNER KITS- STAINLESS STEEL (#304)

Size	Gas Type	Model	Hub Size	Btu	Valve Size	Flex Line
12"x 6"	Natural Gas	FPSR12X6 KIT	1/2"	90k	1/2"	18"
	Liquid Propane	FPSR12X6LP KIT				
18"x 9"	Natural Gas	FPSR18X9 KIT	1/2"	150k	1/2"	18"
	Liquid Propane	FPSR18X9LP KIT				
24"x 12"	Natural Gas	FPSR24X12 KIT	1/2"	150k	1/2"	18"
	Liquid Propane	FPSR24X12LP KIT				
36"x 18"	Natural Gas	FPSR36X18 KIT	1/2"	200k	1/2"	18"
	Liquid Propane	FPSR36X18LP KIT				
48"x 24"	Natural Gas	FPSR48X24HC KIT	3/4"	300k	3/4"	24"
	Liquid Propane	FPSR48X24HCLP KIT				

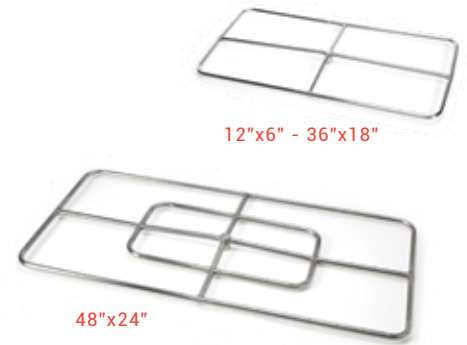

### LINEAR BURNER KITS- TROUGH PAN & T-BURNER STAINLESS STEEL (#304)

Size (A")	Gas Type	Nozzle	Model	Hub Size	Btu	Nozzle BTU	Valve Size	Flex Line
24"	Natural Gas	TOR	FPS/TRGH24 KIT	1/2"	50k	100k	1/2"	18"
	Liquid Propane	TOR	FPS/TRGH24-LP					
36"	Natural Gas	TOR	FPS/TRGH36 KIT	1/2"	75k	125k	1/2"	18"
	Liquid Propane	TOR	FPS/TRGH36-LP					
48"	Natural Gas	TOR	FPS/TRGH48 KIT	1/2"	100k	150k	1/2"	18"
	Liquid Propane	TOR	FPS/TRGH48-LP					
60"	Natural Gas	TOR	FPS/TRGH60 KIT	1/2"	125k	175k	1/2"	18"
	Liquid Propane	TOR	FPS/TRGH60-LP					
72"	Natural Gas	TOR	FPS/TRGH72 KIT	1/2"	150k	200k	1/2"	18"
	Liquid Propane	TOR	FPS/TRGH72-LP					
96"	Natural Gas	TOR	FPS/TRGH96 KIT	1/2"	200k	300k	1/2"	18"
	Liquid Propane	TOR	FPS/TRGH96-LP					



### LINEAR BURNER KITS- INTERLINK PAN & T-BURNER, STAINLESS STEEL (#304)

Size (A")	Gas Type	Nozzle	Model	Hub Size	Btu	Nozzle BTU	Valve Size	Flex Line
25"X 8"	Natural Gas	TOR	FPS/LINEAR25X8 KIT	1/2"	50k	100k	1/2"	18"
	Liquid Propane	TOR	FPS/LINEAR25X8-LP					
37"X 8"	Natural Gas	TOR	FPS/LINEAR37X8 KIT	1/2"	75k	125k	1/2"	18"
	Liquid Propane	TOR	FPS/LINEAR37X8-LP					
49"X 8"	Natural Gas	TOR	FPS/LINEAR49X8 KIT	1/2"	100k	150k	1/2"	18"
	Liquid Propane	TOR	FPS/LINEAR49X8-LP					
61"X 8"	Natural Gas	TOR	FPS/LINEAR61X8 KIT	1/2"	125k	175k	1/2"	18"
	Liquid Propane	TOR	FPS/LINEAR61X8-LP					
73"X 8"	Natural Gas	TOR	FPS/LINEAR73X8 KIT	1/2"	150k	200k	1/2"	18"
	Liquid Propane	TOR	FPS/LINEAR73X8-LP					
97"X 8"	Natural Gas	TOR	FPS/LINEAR97X8 KIT	1/2"	200k	300k	1/2"	18"
	Liquid Propane	TOR	FPS/LINEAR97X8-LP					
121"X 8"	Natural Gas	TOR	FPS/LINEAR121X8 KIT	1/2"	250k	300k	1/2"	18"
	Liquid Propane	TOR	FPS/LINEAR121X8-LP					

#### Features:

- Sidewalls add strength and hold media
- Burner Ports - Staggered
- Removable center section on some models
- Raised Hub Design



### S-FIRE BURNER KITS- STAINLESS STEEL (#304)

Size (A")	Gas Type	Model	Hub Size	Btu	Valve Size	Flex Line
30"x 8"	Natural Gas	FPS/SFIRE30 KIT	1/2"	65k	1/2"	18"
	Liquid Propane	FPS/SFIRE30LP KIT				
36"x 8"	Natural Gas	FPS/SFIRE36 KIT	1/2"	85k	1/2"	18"
	Liquid Propane	FPS/SFIRE36LP KIT				
48"x 10"	Natural Gas	FPS/SFIRE48 KIT	1/2"	110k	1/2"	18"
	Liquid Propane	FPS/SFIRE48LP KIT				
60"x 10"	Natural Gas	FPS/SFIRE60 KIT	1/2"	150k	1/2"	18"
	Liquid Propane	FPS/SFIRE60LP KIT				
72"x 10"	Natural Gas	FPS/SFIRE72 KIT	1/2"	150k	1/2"	18"
	Liquid Propane	FPS/SFIRE72LP KIT				

#### Features:

- Burner Ports - Small Separation for Distinctive S-Pattern Flame
- Raised Hub Design

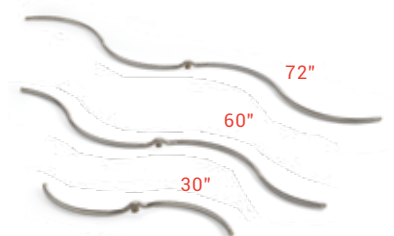

## H-BURNER KITS- STAINLESS STEEL (#304)

Size	Gas Type	Nozzle	Model	Hub Size	Btu	Nozzle BTU	Valve Size	Flex Line
18"x 6"	Natural Gas	TOR	FPS/HBSB18 KIT	1/2"	60k	125k	1/2"	18"
	Liquid Propane	TOR	FPS/HBSB18LP KIT					
24"x 6"	Natural Gas	TOR	FPS/HBSB24 KIT	1/2"	90k	150k	1/2"	18"
	Liquid Propane	TOR	FPS/HBSB24LP KIT					
30"x 8"	Natural Gas	TOR	FPS/HBSB30 KIT	1/2"	90k	200k	1/2"	18"
	Liquid Propane	TOR	FPS/HBSB30LP KIT					
36"x 8"	Natural Gas	TOR	FPS/HBSB36 KIT	1/2"	150k	250k	1/2"	18"
	Liquid Propane	TOR	FPS/HBSB36LP KIT					
48"x 10"	Natural Gas	TOR	FPS/HBSB48 KIT	1/2"	150k	300k	1/2"	18"
	Liquid Propane	TOR	FPS/HBSB48LP KIT					
60"x 10"	Natural Gas	TOR	FPS/HBSB60 KIT	1/2"	250k	300k	1/2"	18"
	Liquid Propane	TOR	FPS/HBSB60LP KIT					
72"x 10"	Natural Gas	TOR	FPS/HBSB72 KIT	1/2"	300k	300k	1/2"	18"
	Liquid Propane	TOR	FPS/HBSB72LP KIT					
84"x 10"	Natural Gas	TOR	FPS/HBSB84 KIT	1/2"	300k	300k	1/2"	18"
	Liquid Propane	TOR	FPS/HBSB84LP KIT					

**Features:**

Burner Ports - Point Inward  
Raised Hub Design



## NATURAL GAS/PROPANE BBQ AND APPLIANCE OUTLET (581)

Designed for Indoor/Outdoor Application  
Heavy Duty 20 Gauge Stainless Steel Outlet Cover  
CSA-AGA/CGA Approved to -40 Degrees F  
60k Btu Natural Gas, 90k Btu Propane Gas  
5 PSIG maximum operation pressure  
Lockable safety feature denies connect/disconnect while gas is flowing.  
Manual gas valve with appliance connection.

Models	Description
580	144"x3/8" with quick disconnect assembly
580-1	144x3/8" with Male Quick Disconnect Only
580-V	Female Quick Disconnect Fitting
581	Appliance Outlet

## NATURAL GAS/LP QUICK DISCONNECT HOSE ASSEMBLY (580)

144" x 3/8" I.D.  
Gray PVC Galvanized Steel Hose  
CSA-AGA/CGA approved to -40 Degrees F  
Quick Disconnect Nipple and Socket dust cap  
Attached Hose and Quick Disconnect Installation Instructions



## FLEX LINE

### STANDARD CAPACITY FLEX LINE

All standard capacity flex lines are 1/2" OD and 3/8" ID with 1/2" female pipe threads on one end and 3/8" male pipe threads on the other.

Model	Length	Max BTU/HR (NG)	Max BTU/HR (LP)	Flare Size	Fittings Included (Two)
SSC6	6"	110,000	177,000	1/2"	3/8" MIP, 1/2" FIP
SSC12	12"	102,000	163,200	1/2"	3/8" MIP, 1/2" FIP
SSC18	18"	93,000	148,960	1/2"	3/8" MIP, 1/2" FIP
SSC24	24"	85,000	136,000	1/2"	3/8" MIP, 1/2" FIP
SSC30	30"	77,000	123,360	1/2"	3/8" MIP, 1/2" FIP
SSC36	36"	71,000	113,760	1/2"	3/8" MIP, 1/2" FIP
SSC48	48"	60,500	96,800	1/2"	3/8" MIP, 1/2" FIP



### HIGH CAPACITY FLEX LINE

All high capacity flex lines are 5/8" OD and 1/2" ID with 1/2" female pipe threads on one end and 1/2" male pipe threads on the other.

Model	Length	Max BTU/HR (NG)	Max BTU/HR (LP)	Flare Size	Fittings Included (Two)
SSC-HC12	12"	180,000	288,000	3/4"	1/2" MIP, 1/2" FIP
SSC-HC18	18"	164,000	262,700	3/4"	1/2" MIP, 1/2" FIP
SSC-HC24	24"	150,000	240,000	3/4"	1/2" MIP, 1/2" FIP
SSC-HC30	30"	136,000	217,600	3/4"	1/2" MIP, 1/2" FIP



### ULTRA HIGH CAPACITY FLEX LINE

All high capacity flex lines are 1" OD and 3/4" ID with 3/4" female pipe threads on one end and 1" male pipe threads on the other.

Model	Length	Max BTU/HR (NG)	Max BTU/HR (LP)	Flare Size	Fittings Included (Two)
SSC-HHC24	24"	291,000	465,400	1"	3/4" MIP, 3/4" FIP
SSC-HHC36	36"	256,000	409,400	1"	3/4" MIP, 3/4" FIP

### TRANQUIL WHISTLE-FREE FLEX LINE

HPC has been a long time supplier of reliable, maintenance-free flex lines. We offer our Tranquil Flex Line Series to eliminate the nuisance whistling found on those tough installs. Sizes available in standard capacity are 12", 18", 24", and 30" lengths. These are stainless steel with 3/8" ID and are in stock and ready for shipment.

Model	Length	Max BTU/HR (NG)	Max BTU/HR (LP)	Flare Size	Fittings Included (Two)
SSC-W12	12"	102,000	163,200	1/2"	3/8" MIP, 1/2" FIP
SSC-W18	18"	93,000	148,960	1/2"	3/8" MIP, 1/2" FIP
SSC-W24	24"	85,000	136,000	1/2"	3/8" MIP, 1/2" FIP
SSC-W30	30"	77,000	123,360	1/2"	3/8" MIP, 1/2" FIP

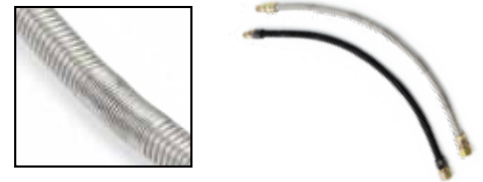

### TRANQUIL WHISTLE-FREE, STANDARD CAPACITY (BLACK)

Model	Length	Max BTU/HR (NG)	Max BTU/HR (LP)	Flare Size	Fittings Included (Two)
SSCB-W18	18"	93,000	148,960	1/2"	3/8" MIP, 1/2" FIP
SSCB-W24	24"	85,000	136,000	1/2"	3/8" MIP, 1/2" FIP
SSCB-W30	30"	77,000	123,360	1/2"	3/8" MIP, 1/2" FIP

\* Natural Gas maximum Btu/hr: Straight Length Capacity; 0.64 SG, 1,000 Btu per Cu. Ft. at .5 water column pressure drop  
\*\* Liquid Propane Maximum Btu/hr: Straight Length Capacity; 1.55 SG, 2,500 Btu per Cu. Ft. at .5 water column pressure drop

# FIRE PIT COMPONENTS

UNASSEMBLED -  
NON-CERTIFIED

**FIRE PIT PANS** May require use of FRSB-11 Burner Brackets - Sold Separately - All Gas Inlets are Welded Nipple

## ROUND BOWL STYLE- STAINLESS STEEL (#304)

Size	Model	Gauge	Inlet	FRSB-11
13"	570-13	18g	1/2"	3
19"	570-19	18g	1/2"	3
25"	570-25	18g	1/2"	3
31"	570-31	18g	1/2"	3
31"	570-31HC	18g	3/4"	3
37"	570-37HC	18g	3/4"	3
43"	570-43HC	18g	3/4"	3



## ROUND FLAT STYLE- STAINLESS STEEL (#304)

Size	Model	Gauge	Inlet	FRSB-11
7.75"	571-8	18g	1/2"	3
13.75"	571-14	18g	1/2"	3
17.75"	571-18	18g	1/2"	3
23.75"	571-24	18g	1/2"	3
29.75"	571-30	18g	1/2"	3
35.75"	571-36	18g	1/2"	3
35.75"	571-36HC	18g	3/4"	3
41.75"	571-42HC	18g	3/4"	3
53.75"	571-54HC	18g	3/4"	3



## SQUARE FLAT STYLE- STAINLESS STEEL (#304)

Size	Model	Gauge	Inlet	FRSB-11
18"	571-18SQ	18g	1/2"	3
24"	571-24SQ	18g	1/2"	3
30"	571-30SQ	18g	1/2"	3
36"	571-36HCSQ	18g	3/4"	3
42"	571-42HCSQ	18g	3/4"	3



## SQUARE BOWL STYLE- STAINLESS STEEL (#304)

Size	Model	Gauge	Inlet	FRSB-11
18"	570-18SQ	18g	1/2"	3
24"	570-24SQ	18g	1/2"	3
30"	570-30SQ	18g	1/2"	3
36"	570-36HCSQ	18g	3/4"	3
42"	570-42HCSQ	18g	3/4"	3



### LINEAR TROUGH STYLE

Sold with T-Burner - See Pg. 58



### LINEAR INTERLINK STYLE

Sold with T-Burner - See Pg. 58



### RECTANGLE BOWL STYLE

Sold with H-Burner - See Pg. 58

### FRSB-11 BRACKET

This unique bracket is universal to all HPC burners making them more rigid than competitive models.



## REGULATORS



### 770-150

150k Btu pressure regulator  
Natural Gas : 5 psi input  
Liquid Propane: 2 psi input  
1/2"x1/2", 4"-12" water column



### 770-300

300k Btu pressure regulator  
Natural Gas : 5 psi input  
Liquid Propane: 2 psi input  
1"x1", 4"-12" water column



### 658

100k Btu LP pressure regulator  
3/8" x 3/8", 4"-12" water column



### 770-13A15

MAXITROL Vent protector with a 1/8" inlet made for 770-150



### 770-13A15-5

MAXITROL Vent protector with a 3/8" inlet made for 770-300

## GRILL REPAIR REGULATOR & HOSE - LP



### 658/90-18

18" Rubber Hose  
90 degree Regulator  
100k Btu, 3/8 Fitting

### 658/90-36

36" Rubber Hose  
90 degree Regulator  
100k Btu, 3/8 Fitting



### 658SS/90-36

36" Braided SS Hose  
90 degree Regulator  
100k Btu, 3/8 Fitting

## PUSH BUTTON IGNITION KITS

This hard pipe unassembled kit include stainless steel pan and burner, push button ignition switch and igniter, chrome decorative key valve, fittings and flex line. **Natural Gas Only** (Not certified).

## ROUND BOWL INSERTS / NON CERTIFIED

Size	Gas type	Nozzle	Model	Burner	Max BTU	Nozzle BTU
19"	Natural Gas	TOR	PENTA19FPK-NG	12" Penta	90k	90k
25"	Natural Gas	TOR	PENTA25FPK-NG	18" Penta	150k	140k
31"	Natural Gas	TOR	PENTA31FPK-NG	24" Penta	150k	185k



Push Button Ignition

## ROUND FLAT INSERTS

Size	Gas type	Nozzle	Model	Burner	Max BTU	Nozzle BTU
18"	Natural Gas	TOR	PENTA18FPK-NG	12" Penta	90k	90k
24"	Natural Gas	TOR	PENTA24FPK-NG	18" Penta	150k	140k
30"	Natural Gas	TOR	PENTA30FPK-NG	24" Penta	150k	185k



## SQUARE FLAT INSERTS

Size	Gas type	Nozzle	Model	Burner	Max BTU	Nozzle BTU
18"	Natural Gas	TOR	PENTA18FPK-SQ-NG	12" Penta	90k	90k
24"	Natural Gas	TOR	PENTA24FPK-SQ-NG	18" Penta	150k	140k
30"	Natural Gas	TOR	PENTA30FPK-SQ-NG	24" Penta	150k	185k



56 **WARNING: California PROP 65:** This product can expose you to Lead & Chromium, which is known to the State of California to cause cancer and birth defects or other reproductive harm. For more information go to [www.P65Warnings.ca.gov](http://www.P65Warnings.ca.gov).

Inspired by safety. Innovated for your lifestyle.



**FLAME CONTROL SYSTEMS**

**DECORATIVE KEY VALVES**

**Key Valve Part Numbers:** Key Valves are numbered as either Angled or Straight, and based off of color. For example, MAFB is described as Manual Angled Flat Black. MSFB would be Manual Straight Flat Black.

**STANDARD CAPACITY VALVES (1/2")**

1/4 Turn angle or straight manual ball valve with flange and key. 1/2" inlet and outlet. For floor or wall mounting.

**Recommended for gas shut off of 150k Btu or less**

**HIGH CAPACITY VALVES (3/4")**

1/4 Turn angle or straight manual ball valve with flange and key. 3/4" inlet and outlet. For floor or wall mounting.

**Recommended for gas shut off of 400k Btu or less**



**CHROME FLANGE/ KEY**

Valve	Inlet / Outlet	Models
Angle	1/2"	MACB
	3/4"	MACB-HC
Straight	1/2"	MSCB
	3/4"	MSCB-HC



**BRASS FLANGE/ KEY**

Valve	Inlet / Outlet	Models
Angle	1/2"	MABB
	3/4"	MABB-HC
Straight	1/2"	MSBB
	3/4"	MSBB-HC



**FLAT BLACK FLANGE/ KEY**

Valve	Inlet / Outlet	Models
Angle	1/2"	MAFB
	3/4"	MAFB-HC
Straight	1/2"	MSFB
	3/4"	MSFB-HC



**PEWTER FLANGE/ KEY**

Valve	Inlet / Outlet	Models
Angle	1/2"	MAPW
	3/4"	MAPW-HC
Straight	1/2"	MSPW
	3/4"	MSPW-HC



**ANTIQUe BRASS FLANGE/ KEY**

Valve	Inlet / Outlet	Models
Angle	1/2"	MAAB
	3/4"	MAAB-HC
Straight	1/2"	MSAB
	3/4"	MSAB-HC



**ANTIQUe COPPER FLANGE/ KEY**

Valve	Inlet / Outlet	Models
Angle	1/2"	MAAC
	3/4"	MAAC-HC
Straight	1/2"	MSAC
	3/4"	MSAC-HC



**FLANGE AND KEY ONLY**

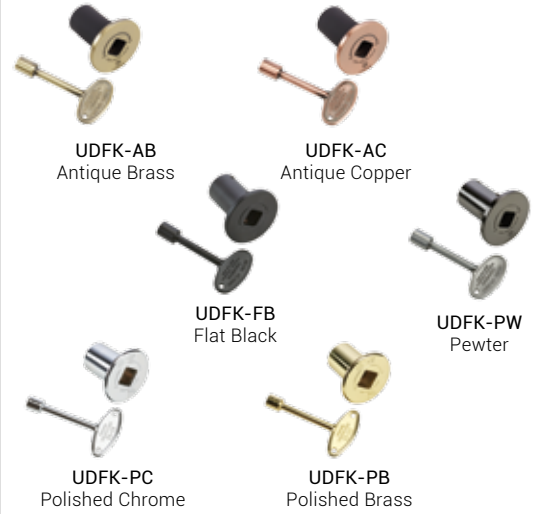

**KEYS**



**FLANGE ONLY**

- 304 L Polished Chrome Flange
- 306 L Polished Brass Flange

# FIRE PIT COMPONENTS

UNASSEMBLED -  
NON-CERTIFIED

## MANUAL SPARK, FLAME SENSING (FPPK) CONTROL SYSTEMS

This system utilizes a standing pilot with thermocouple sensing to safely control gas flow, manual flame height adjustment, manual switch spark igniter (battery operated), and a safety pilot valve mounted in a stainless steel box.



Size: 7.5"x6.5"x2.6"

Max BTU	Gas Type	Models
140k	Natural Gas	FPPK-HC-NG
	Liquid Propane	FPPK-HC-LP
90k	Natural Gas	FPPK-MC-NG
	Liquid Propane	FPPK-MC-LP

PILOT ASSEMBLY AND BLOWOUT BOX

See chart for recommended burner size.

*Includes:* Assembled stainless steel control box, 36" pilot assembly with spark igniter, and blowout box, flex line, hard pipe, and fittings.

### Recommended FPPK Burner Size

Burner Type	Size w/ FPPK-HC	Size w/ FPPK-MC
Penta Series	18" ~ 30"	12" ~ 24"
Round Burner	18" ~ 30"	12" ~ 18"
H-Burner Series	30"X8" ~ 48"X10"	24"X6" ~ 30"X8"
Square Burner	18" ~ 24"	12" ~ 18"
T-Burner	50" ~ 72"	36" ~ 48"

**NOTE:** Burner too small could result in unsafe LP backpressure. Burner too large could result in small, undesirable flame height.

## COMMERCIAL AUTOMATIC SHUTOFF TIMERS - 120VAC



**694** 2 Hour Timer  
**695** 12 Hour Timer  
Stainless Steel Rotary Timer (SPDT, 20A)  
1/2" deep. Double gang box recommended. For use with NEMA 3R box for mounting.



**694 NEMA** 2 Hour Timer  
**695 NEMA** 12 Hour Timer  
NEMA 3R Box with 694 or 695 timer. Includes timer mounted into the NEMA 3R box for your convenience.



**696** 2, 4, 8 and 12 Hour Timer  
Four preset switch for indoors. Can be set at 2, 4, 8, and 12 hours (SPDT, 20A). Fits single Gangbox

Available Now!!!



**GT-ESTOP-2.5** 2.5 Hour Timer  
A combination of an "Emergency Stop" control switch, plus a Gas-turn-off timer that is adjustable up to 2-1/2 hours.  
**NG** - 290,000 BTU/hr Max Capacity  
**LP** - 430,000 BTU/hr Max Capacity

## POWER SUPPLIES - FOR 24VAC & 12VAC MODELS

Input Primary - 120VAC, 60/50Hz, 1A max  
Output Secondary - 24VAC & 12VAC, 60/50Hz, 4A



24VAC Model	Style	For use with
311-PS1	1 Output	24 VAC Inserts
311-PS3	3 Outputs	24 VAC Inserts
311-PS5	5 Outputs	24 VAC Inserts

12VAC Model	Style	For use with
313-PS1	1 Output	12 VAC Copper
313-PS3	3 Outputs	12 VAC Copper
313-PS5	5 Outputs	12 VAC Copper

## COMMERCIAL EMERGENCY STOP - 120VAC, 24VAC OR 12VAC

Perfect for commercial applications of Evolution 360 or EI systems. Push button with keyed reset allows supervisor confirmation. Safely turns off up to 3 circuits plus one fail safe function.



**311-ESTOP-3**  
Size: 2.8" x 2.8" x 4", Rated for 600VA, 10A  
Rated IP65 - Protection against dust and low pressure water from all directions.

For replacement Keys use product number:  
**E-STOP-KEY**

## 120 VAC OUTDOOR ON/OFF REMOTE CONTROL



**578-C**  
Used with EI Fire Pit Systems. 120 VAC models only. CARLON in-line power control with 3 prong in/out.



The LP Kit includes the burner, properly sized air mixer, and fittings.  
The NG Kit includes the burner.

**PENTA BURNERS- STAINLESS STEEL (#304)**

Size	Gas Type	Nozzle	Model	Inlet	Btu	Nozzle BTU
12"	Natural Gas	TOR	PENTA12 KIT	1/2"	65k	100k
	Liquid Propane	TOR	PENTA12LP KIT			
18"	Natural Gas	TOR	PENTA18 KIT	1/2"	125k	175k
	Liquid Propane	TOR	PENTA18LP KIT			
24"	Natural Gas	TOR	PENTA24 KIT	1/2"	200k	250k
	Liquid Propane	TOR	PENTA24LP KIT			
30"	Natural Gas	TOR	PENTA30 KIT	3/4"	250k	300k
	Liquid Propane	TOR	PENTA30LP KIT			
36"	Natural Gas	TOR	PENTA36 KIT	3/4"	300k	350k
	Liquid Propane	TOR	PENTA36LP KIT			
48"	Natural Gas	TOR	PENTA48 KIT	3/4"	300k	350k
	Liquid Propane	TOR	PENTA48LP KIT			

5% DISCOUNT		
Nozzle	Model	Bulk Qty.
TOR	PENTA12	10
TOR	PENTA18	10
TOR	PENTA24	10
TOR	PENTA30	5
TOR	PENTA36	5
TOR	PENTA48	5

**BULK CARTON**

**INCLUDES BURNERS ONLY**

**Features:**  
Burner Ports-9 and 3 o'clock  
Raised Hub Design  
Patented Technology



Penta Burner

See Pg. 11 for Penta Burner Features

**ROUND BURNER- STAINLESS STEEL (#304)**

Size	Gas Type	Model	Inlet	Btu
6"	Natural Gas	FRS-6 KIT	1/2"	60k
	Liquid Propane	FRS-6LP KIT		
12"	Natural Gas	FRS-12 KIT	1/2"	90k
	Liquid Propane	FRS-12LP KIT		
18"	Natural Gas	FRS-18 KIT	1/2"	150k
	Liquid Propane	FRS-18LP KIT		
24"	Natural Gas	FRS-24 KIT	1/2"	150k
	Liquid Propane	FRS-24LP KIT		
24" (HC)	Natural Gas	FRS-24HC KIT	3/4"	300k
	Liquid Propane	FRS-24HCLP KIT		
30"	Natural Gas	FRS-30 KIT	1/2"	300k
	Liquid Propane	FRS-30LP KIT		
30" (HC)	Natural Gas	FRS-30HC KIT	3/4"	300k
	Liquid Propane	FRS-30HCLP KIT		
36"	Natural Gas	FRS-36HC KIT	3/4"	300k
	Liquid Propane	FRS-36HCLP KIT		
48"	Natural Gas	FRS-48HC KIT	3/4"	300k
	Liquid Propane	FRS-48HCLP KIT		

5% DISCOUNT	
Model	Bulk Qty.
FRS6	10
FRS12	10
FRS18	10
FRS24	10
FRS24HC	10
FRS30	5
FRS30HC	5
FRS36HC	5
FRS48HC	5

**BULK CARTON**

**INCLUDES BURNERS ONLY**

**Features:**  
Burner Ports - Staggered  
Raised Hub Design



**SQUARE BURNERS- STAINLESS STEEL (#304)**

Size	Gas Type	Model	Inlet	Btu
12"	Natural Gas	FRSSQ-12 KIT	1/2"	90k
	Liquid Propane	FRSSQ-12LP KIT		
18"	Natural Gas	FRSSQ-18 KIT	1/2"	150k
	Liquid Propane	FRSSQ-18LP KIT		
24"	Natural Gas	FRSSQ-24 KIT	1/2"	150k
	Liquid Propane	FRSSQ-24LP KIT		
36"	Natural Gas	FRSSQ-36HC KIT	3/4"	300k
	Liquid Propane	FRSSQ-36HCLP KIT		
48"	Natural Gas	FRSSQ-48HC KIT	3/4"	300k
	Liquid Propane	FRSSQ-48HCLP KIT		

5% DISCOUNT	
Model	Bulk Qty.
FRSSQ12	10
FRSSQ18	10
FRSSQ24	10
FRSSQ36HC	5
FRSSQ48HC	5

**BULK CARTON**

**INCLUDES BURNERS ONLY**

**Features:**  
Burner Ports - Staggered  
Raised Hub Design



## RECTANGLE BURNERS- STAINLESS STEEL (#304)

Size	Gas Type	Model	Inlet	Btu
12" x 6"	Natural Gas	FRSR-12X6 KIT	1/2"	90k
	Liquid Propane	FRSR-12X6LP KIT		
18" x 9"	Natural Gas	FRSR-18X9 KIT	1/2"	150k
	Liquid Propane	FRSR-18X9LP KIT		
24" x 12"	Natural Gas	FRSR-24X12 KIT	1/2"	150k
	Liquid Propane	FRSR-24X12LP KIT		
36" x 18"	Natural Gas	FRSR-36X18 KIT	1/2"	200k
	Liquid Propane	FRSR-36X18LP KIT		
48" x 24"	Natural Gas	FRSR-48X24HC KIT	3/4"	300k
	Liquid Propane	FRSR-48X24HCLP KIT		

5% DISCOUNT	
Model	Bulk Qty.
FRSR12X6	10
FRSR18X9	10
FRSR24X12	10
FRSR36X18	5
FRSR48X24HC	5
<b>INCLUDES BURNERS ONLY</b>	

12" x 6" ~ 36" x 18"

**Features:**  
Burner Ports - Staggered  
Raised Hub Design

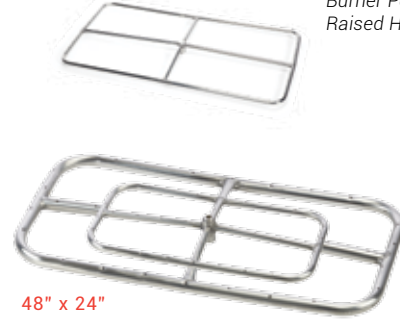

48" x 24"

## LINEAR BURNERS- INTERLINK PAN & T-BURNER, STAINLESS STEEL (#304)

Size (A")	Gas Type	Nozzle	Model	Inlet	Btu	Nozzle BTU
25" X 8"	Natural Gas	TOR	IL25X8SS	1/2"	50k	100k
	Liquid Propane	TOR	IL25X8SS-LP			
37" X 8"	Natural Gas	TOR	IL37X8SS	1/2"	75k	125k
	Liquid Propane	TOR	IL37X8SS-LP			
49" X 8"	Natural Gas	TOR	IL49X8SS	1/2"	100k	150k
	Liquid Propane	TOR	IL49X8SS-LP			
61" X 8"	Natural Gas	TOR	IL61X8SS	1/2"	125k	175k
	Liquid Propane	TOR	IL61X8SS-LP			
73" X 8"	Natural Gas	TOR	IL73X8SS	1/2"	150k	200k
	Liquid Propane	TOR	IL73X8SS-LP			
97" X 8"	Natural Gas	TOR	IL97X8SS	1/2"	200k	250k
	Liquid Propane	TOR	IL97X8SS-LP			
121" X 8"	Natural Gas	TOR	IL121X8SS	1/2"	250k	300k
	Liquid Propane	TOR	IL121X8SS-LP			

**Features:**  
Sidewalls add strength and hold media  
Burner Ports - Staggered  
Removable center section on some models  
Raised Hub Design

**Includes:**  
Pan, Burner and Brackets



## LINEAR BURNERS- TROUGH PAN & T-BURNER STAINLESS STEEL (#304)

Size (A")	Gas Type	Nozzle	Model	Inlet	Btu	Nozzle BTU
24"	Natural Gas	TOR	24SS TRGH	1/2"	50k	100k
	Liquid Propane	TOR	24SS TRGH-LP			
36"	Natural Gas	TOR	36SS TRGH	1/2"	75k	125k
	Liquid Propane	TOR	36SS TRGH-LP			
48"	Natural Gas	TOR	48SS TRGH	1/2"	100k	150k
	Liquid Propane	TOR	48SS TRGH-LP			
60"	Natural Gas	TOR	60SS TRGH	1/2"	125k	175k
	Liquid Propane	TOR	60SS TRGH-LP			
72"	Natural Gas	TOR	72SS TRGH	1/2"	150k	200k
	Liquid Propane	TOR	72SS TRGH-LP			
96"	Natural Gas	TOR	96SS TRGH	1/2"	200k	250k
	Liquid Propane	TOR	96SS TRGH-LP			



**Includes:**  
Pan, Burner and Brackets

**Features:**  
Sidewalls add Rigidity  
Burner Ports - Staggered

## RECTANGLE BURNERS- STAINLESS STEEL (#304)

Size (A")	Gas Type	Nozzle	Model	Inlet	Btu	Nozzle BTU
24" x 12"	Natural Gas	TOR	24X12SS-H	1/2"	60k	125k
	Liquid Propane	TOR	24X12SS-H-LP			
30" x 12"	Natural Gas	TOR	30X12SS-H	1/2"	90k	150k
	Liquid Propane	TOR	30X12SS-H-LP			
36" x 14"	Natural Gas	TOR	36X14SS-H	1/2"	90k	175k
	Liquid Propane	TOR	36X14SS-H-LP			
42" x 14"	Natural Gas	TOR	42X14SS-H	1/2"	150k	200k
	Liquid Propane	TOR	42X14SS-H-LP			
54" x 16"	Natural Gas	TOR	54X16SS-H	1/2"	150k	250k
	Liquid Propane	TOR	54X16SS-H-LP			
66" x 16"	Natural Gas	TOR	66X16SS-H	1/2"	250k	300k
	Liquid Propane	TOR	66X16SS-H-LP			
78" x 16"	Natural Gas	TOR	78X16SS-H	1/2"	300k	300k
	Liquid Propane	TOR	78X16SS-H-LP			
90" x 16"	Natural Gas	TOR	90X16SS-H	1/2"	300k	300k
	Liquid Propane	TOR	90X16SS-H-LP			

**Features:**  
Burner Ports - Staggered  
Raised Hub Design  
Sidewalls add Structure and Hold Media

**Includes:**  
Pan, Burner and Brackets



## LINEAR T-BURNERS- RAISED, STAINLESS STEEL (#304)

Size	Gas Type	Nozzle	Model	Inlet	Btu	Nozzle BTU
24"	Natural Gas	TOR	LTBSS24	1/2"	50k	100k
	Liquid Propane	TOR	LTBSS24LP			
36"	Natural Gas	TOR	LTBSS36	1/2"	75k	125k
	Liquid Propane	TOR	LTBSS36LP			
48"	Natural Gas	TOR	LTBSS48	1/2"	100k	150k
	Liquid Propane	TOR	LTBSS48LP			
60"	Natural Gas	TOR	LTBSS60	1/2"	125k	175k
	Liquid Propane	TOR	LTBSS60LP			
72"	Natural Gas	TOR	LTBSS72	1/2"	150k	200k
	Liquid Propane	TOR	LTBSS72LP			
96"	Natural Gas	TOR	LTBSS96	1/2"	200k	250k
	Liquid Propane	TOR	LTBSS96LP			
120"	Natural Gas	TOR	LTBSS120	1/2"	250k	300k
	Liquid Propane	TOR	LTBSS120LP			

5% DISCOUNT		
Nozzle	Model	Bulk Qty.
TOR	LTBSS24	10
TOR	LTBSS36	10
TOR	LTBSS48	10
TOR	LTBSS60	10
TOR	LTBSS72	10
TOR	LTBSS96	5
TOR	LTBSS120	5

**BULK CARTON**

**INCLUDES BURNERS ONLY**

**Features:**

Burner Ports - Staggered  
Raised Hub Design



## S-FIRE BURNERS- STAINLESS STEEL (#304)

Size	Gas Type	Model	Inlet	Btu
30"	Natural Gas	SFIRE30 KIT	1/2"	75K
	Liquid Propane	SFIRE30LP KIT		
36"	Natural Gas	SFIRE36 KIT	1/2"	85K
	Liquid Propane	SFIRE36LP KIT		
48"	Natural Gas	SFIRE48 KIT	1/2"	110K
	Liquid Propane	SFIRE48LP KIT		
60"	Natural Gas	SFIRE60 KIT	1/2"	135K
	Liquid Propane	SFIRE60LP KIT		
72"	Natural Gas	SFIRE72 KIT	1/2"	165K
	Liquid Propane	SFIRE72LP KIT		

5% DISCOUNT	
Model	Bulk Qty.
SFIRE30	10
SFIRE36	10
SFIRE48	10
SFIRE60	10
SFIRE72	10

**BULK CARTON**

**INCLUDES BURNERS ONLY**

**Features:**

Burner Ports - Small  
Separation for Distinctive  
S-Pattern Flame  
Raised Hub Design

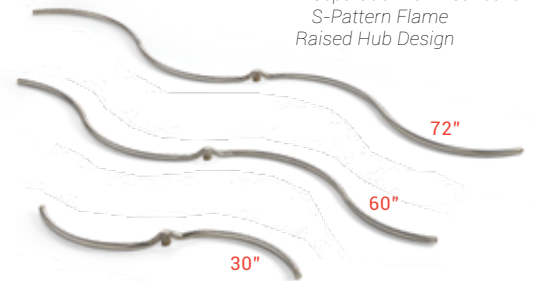

## FIRE PIT H-BURNERS- STAINLESS STEEL (#304)

Size	Gas Type	Nozzle	Model	Inlet	Btu	Nozzle BTU
18"x 6"	Natural Gas	TOR	HBSB18 KIT	1/2"	60k	125k
	Liquid Propane	TOR	HBSB18LP KIT			
24"x 6"	Natural Gas	TOR	HBSB24 KIT	1/2"	90k	150k
	Liquid Propane	TOR	HBSB24LP KIT			
30"x 8"	Natural Gas	TOR	HBSB30 KIT	1/2"	90k	175k
	Liquid Propane	TOR	HBSB30LP KIT			
36"x 8"	Natural Gas	TOR	HBSB36 KIT	1/2"	150k	200k
	Liquid Propane	TOR	HBSB36LP KIT			
48"x 10"	Natural Gas	TOR	HBSB48 KIT	1/2"	150k	250k
	Liquid Propane	TOR	HBSB48LP KIT			
60"x 10"	Natural Gas	TOR	HBSB60 KIT	1/2"	250k	300k
	Liquid Propane	TOR	HBSB60LP KIT			
72"x 10"	Natural Gas	TOR	HBSB72 KIT	1/2"	300k	300k
	Liquid Propane	TOR	HBSB72LP KIT			
84"x 10"	Natural Gas	TOR	HBSB84 KIT	1/2"	300k	300k
	Liquid Propane	TOR	HBSB84LP KIT			

5% DISCOUNT		
Nozzle	Model	Bulk Qty.
TOR	HBSB18	10
TOR	HBSB24	10
TOR	HBSB30	10
TOR	HBSB36	10
TOR	HBSB48	10
TOR	HBSB60	10
TOR	HBSB72	10
TOR	HBSB84	10

**BULK CARTON**

**INCLUDES BURNERS ONLY**

**Features:**

Burner Ports - Point Inward  
Raised Hub Design



# FIRE PIT COMPONENTS



Photo - HPC Fire Inspired™

## LOG LIGHTER BURNER- STAINLESS STEEL

Includes - stainless steel burner tube, LP air mixer or NG orifice, connector and end cap, El. Can be connected together in sections.

Custom Lengths Available

Model #	Size in inches	Gas
SS17N	17"	NG
SS17P	17"	LP



## MISCELLANEOUS PARTS

### SPARK IGNITER COMPONENTS



690-AA

Mounts easily with 2 screws. Use with external switch.  
AA batteries easy to replace.  
Sealed battery compartment.  
Dual ignition outlets  
(Replaces #690)



691AA-HPC

Screw-in cap holds unit in place.  
Uses 1 AA battery. Sealed battery chamber. Easy Battery Replacement



130

Snap-in Type  
One spark per button push.



131

Electrode to use with the 130 Spark Igniter pictured to the left

### FPK PUSH BUTTON SPARK IGNITION KIT

Includes Spark Generator, Ignition, Mounting Plate and AA Battery



FPK

### FPLP SERIES SMALL LP TANK CONVERSION KIT

Includes Regulator, Air Mixer, 12' Hose with quick disconnect, shut off valve, and fittings.  
Minimum Burner Size: 12"  
Minimum T-Burner Size: 48"  
IMPORTANT: If using glass media, glass application to burner must be minimal to avoid backpressure. Read instructions carefully.  
Not for use with HPC **Certified** Inserts



FPLP40 - 40k Btu  
FPLP90 - 90k Btu

## REPLACEMENT COMPONENTS

### EI SERIES REPLACEMENT COMPONENTS

Item	Model
<b>On/Off &amp; High/Low Models</b>	
Hot Surface Igniter	312-IGNITER
Thermocouple- 36"	311-T/C
Electronic Module	312-EIMOD
Transformer	576-75VA
Fuse (5A)	See Note*

Item	Model
<b>On / Off Models Only</b>	
Gas Valve	210-EI415

\*Commonly found fast acting 5A Fuse

Item	Model
<b>High / Low Models Only</b>	
Remote- Handheld	312-REMOTE
Remote- Transceiver	312-W/T
Antenna	312-ANTENNA
Antenna Bracket	312-AB
Antenna Extension Cable - 60"	AEK-60HI/LO
Gas Valve- 2 Stage	312-2STAGE415

### EI SERIES REPLACEMENT PILOT ASSEMBLIES - ON/OFF & HI/LO MODELS

Gas	Btu Rating (Main)	Model	Length
NG	50K ~ 275k	HSIP-36SS	36"
NG	300k Btu	HSIP-36SS-300NG	36"
NG	400k	HSIP-36SS-400NG	36"
LP	50K ~ 225k Btu	HSIP-36SS-50 / 225LP	36"
LP	250k ~ 400k Btu	HSIP-36SS-250 / 400LP	36"

## REPLACEMENT COMPONENTS

### HWI SERIES REPLACEMENT COMPONENTS

**PLEASE NOTE:** FOR MVK-HWI Control box we require the box be returned for repair. Please call use for support!



120-HWI  
Burner Mount Clamp



311-T/C  
36" Thermocouple



311-T/C 72  
72" Thermocouple



311-T/C EXT  
36" Extension



598HWI  
Blowout Box



HWI-913  
Igniter Repair Kit

### HWI SERIES REPLACEMENT PILOT ASSEMBLIES



Gas	Btu Rating (Main)	Model	Length
NG	50K ~ 275k	HWIP-36SS	36"
NG	300k Btu	HWIP-36SS-300NG	36"
NG	400k	HWIP-36SS-400NG	36"

Gas	Btu Rating (Main)	Model	Length
LP	50K ~ 225k Btu	HWIP-36SS-50 / 225LP	36"
LP	250k ~ 400k Btu	HWIP-36SS-250 / 400LP	36"

### FPPK SERIES REPLACEMENT COMPONENTS



108-C  
Safety Pilot Valve  
(90k), FPPK-NG



109-C  
Safety Pilot Valve (90k),  
Rear Inlet Valve, 2010  
FPPK Model



110  
Safety Pilot Valve  
(90k), Side Inlet, used  
in FPPK-MC Box



691AA-HPC  
Igniter Switch



FPPK-P36 NG  
FPPK-P36 LP  
36" Pilot Tube, T/C



598HWI  
Blowout Box



111  
Black Knob



902  
Valve Face Plate  
Nut (For 108-C  
Valve)



100-HC  
High Capacity Valve  
(140k) used in  
FPPK-HC Box



693  
Igniter

### FPK SERIES REPLACEMENT COMPONENTS



131  
Spark Electrode



691AA-HPC  
Igniter Switch

### OTHER ELECTRONIC IGNITION COMPONENTS



576-40VA  
24VAC Transformer - 40VA



576-100VA  
24VAC Transformer - 100VA



210-EI  
Honeywell 150k Valve



210-EIHC  
Honeywell 270k Valve



210-EI415  
Honeywell 415K Valve



210-EI MOD  
Honeywell IPI Module

# FIRE PIT ACCESSORIES CHART

THIS CHART WILL HELP YOU DETERMINE WHAT SIZE AND HOW MUCH OF AN ACCESSORY IS NEEDED

	OPTIONAL COMPONENTS				MEDIA		
	Vinyl Covers**	Outdoor Logs***	Wind Guards****	Install Collar IC44SS-FF	Lava Rock or Rolled Lava	Decorative Glass	River Rock
Size	(Pg. 48)	(Pg. 43)	(Pg. 46)	2 per box (Pg. 51)	(Pg. 44)	(Pg. 45)	(Pg. 44)

## ROUND BOWL INSERTS (PG. 14)

					1 Bag ~ 1/2 cu. ft.	(Lbs)	(Box)
13"	FPC-35	FPL18xx	WG23-RD	1 Box	1 Bag	20	1
19"	FPC-45	FPL18xx	WG30-RD	1 Box	2 Bags	40	1
25"	FPC-45	FPL18xx	WG30-RD	1 Box	2 Bags	60	2
31"	FPC-53	FPL18xx	WG38-RD	1 Box	2 Bags	90	3
37"	FPC-53	FPL30xx	WG48-RD	2 Boxes	4 Bags	120	4
43"	FPC-64	FPL30xx	WG48-RD	2 Boxes	4 Bags	160	5

## ROUND FLAT INSERTS (PG. 16)

14"	FPC-35	FPL18xx	WG23-RD	1 Box	1 Bag	30	1
18"	FPC-45	FPL18xx	WG23-RD	1 Box	2 Bags	30	1
24"	FPC-45	FPL18xx	WG30-RD	1 Box	2 Bags	50	2
30"	FPC-53	FPL18xx	WG38-RD	2 Boxes	2 Bags	80	3
36"	FPC-53	FPL30xx	WG38-RD	2 Boxes	4 Bags	110	4
42"	FPC-64	FPL30xx	WG48-RD	2 Boxes	4 Bags	150	5
54"	FPC-76	FPL30xx	N/A	3 Boxes	6 Bags	250	8

## SQUARE BOWL INSERTS (PG. 18)

18"	FPC-48SQ	FPL18xx	WG25-SQ	1 Box	2 Bags	40	1
24"	FPC-48SQ	FPL18xx	WG31-SQ	2 Boxes	2 Bags	70	2
30"	FPC-60SQ	FPL18xx	WG37-SQ	2 Boxes	2 Bags	110	3
36"	FPC-60SQ	FPL30xx	WG43-SQ	2 Boxes	6 Bags	150	4
42"	FPC-60SQ	FPL30xx	WG49-SQ	2 Boxes	6 Bags	190	4

## SQUARE FLAT INSERTS (PG. 20)

18"	FPC-48SQ	FPL18xx	WG25-SQ	1 Box	2 Bags	40	1
24"	FPC-48SQ	FPL18xx	WG31-SQ	2 Boxes	2 Bags	70	2
30"	FPC-60SQ	FPL18xx	WG37-SQ	2 Boxes	2 Bags	100	3
36"	FPC-60SQ	FPL30xx	WG43-SQ	2 Boxes	6 Bags	140	4
42"	FPC-60SQ	FPL30xx	WG49-SQ	2 Boxes	6 Bags	190	4

## RECTANGLE BOWL INSERTS (PG. 22)

24X12"	FPC-62X30	FPL18xx	WG31X19-RECT	1 Box	2 Bags	40	1
30X12"	FPC-62X30	FPL18xx	WG37X19-RECT	1 Box	2 Bags	40	2
36X14"	FPC-78X40	FPL30xx	WG43X21-RECT	2 Boxes	2 Bags	60	2
42X14"	FPC-78X40	FPL30xx	WG49X21-RECT	2 Boxes	2 Bags	70	3
54X16"	FPC-78X40	FPL30xx	WG61X23-RECT	2 Boxes	4 Bags	100	3
66X16"	FPC-90X40	FPL30xx	N/A	2 Boxes	6 Bags	120	4
78X16"	FPC-102X40	FPL30xx (2)	N/A	3 Boxes	6 Bags	140	4
90X16"	FPC-114X40	FPL30xx (2)	N/A	3 Boxes	8 Bags	160	5

## S-FIRE BURNER INSERTS (PG. 24)

36X14"	FPC-78X40	FPL18xx	WG43X21-RECT	2 Boxes	2 Bags	60	2
42X14"	FPC-78X40	FPL18xx	WG49X21-RECT	2 Boxes	2 Bags	70	3
54X16"	FPC-78X40	FPL30xx	WG61X23-RECT	2 Boxes	4 Bags	100	3
66X16"	FPC-90X40	FPL30xx	N/A	2 Boxes	6 Bags	120	4
78X16"	FPC-102X40	FPL30xx	N/A	3 Boxes	6 Bags	140	4



**THIS CHART WILL HELP YOU DETERMINE WHAT SIZE AND HOW MUCH OF AN ACCESSORY IS NEEDED**

	OPTIONAL COMPONENTS				MEDIA		
	Vinyl Covers**	Outdoor Logs***	Wind Guards****	Install Collar IC44SS-FF	Lava Rock or Rolled Lava	Decorative Glass	River Rock
Size	(Pg. 48)	(Pg. 43)	(Pg. 46)	2 per box (Pg. 51)	(Pg. 44)	(Pg. 45)	(Pg. 44)

**LINEAR TROUGH INSERTS (PG. 26)**

24"	FPC-44X30	FPL18xx	WG31X15-L	1 Box	1 Bag	20	1
36"	FPC-62X30	FPL18xx	WG43X15-L	2 Boxes	2 Bags	30	1
48"	FPC-62X30	FPL30xx	WG55X15-L	2 Boxes	2 Bags	40	1
60"	FPC-94X30	FPL30xx	WG67X15-L	2 Boxes	2 Bags	40	1
72"	FPC-94X30	FPL30xx (2)	N/A	2 Boxes	2 Bags	50	2
96"	FPC-130X30	FPL30xx (3)	N/A	2 Boxes	2 Bags	60	2

**LINEAR INTERLINK INSERTS (PG. 28)**

25X8"	FPC-44X30	FPL18xx	WG31X15-L	1 Box	1 Bag	20	1
37X8"	FPC-62X30	FPL18xx	WG43X15-L	2 Boxes	2 Bags	30	1
49X8"	FPC-62X30	FPL30xx	WG55X15-L	2 Boxes	2 Bags	40	1
61X8"	FPC-94X30	FPL30xx	WG67X15-L	2 Boxes	2 Bags	40	2
73X8"	FPC-94X30	FPL30xx (2)	N/A	2 Boxes	4 Bags	50	2
97X8"	FPC-130X30	FPL30xx (3)	N/A	2 Boxes	4 Bags	60	2
121X8"	FPC-130X30	FPL30xx (3)	N/A	3 Boxes	6 Bags	80	3

**Notes: \*\*Vinyl Covers: Part numbers listed are commonly used sizes- other vinyl sizes and Hard Covers available (Pg. 49).**

**\*\*\*Outdoor Logs: Part numbers listed are commonly used sizes- other sizes available (Pg. 44).**

**\*\*\*\*Wind Guards: Part numbers listed are commonly used sizes- For extra large fire pits, multiple wind guards can be combined to accommodate the larger size - other sizes available (Pg. 47).**

# POP DISPLAYS

## HPC DISPLAY KIOSK



HPC offers a very appealing and educational kiosk for your store front. It is constructed of long-lasting steel and powder coated for a professional look- and is very simple to assemble. The kiosk explains in Layman terms how to select and construct the style, shape, and technology of their fire pit with the help of the Dealer while using HPC fire pit inserts. The Kiosk Kit includes the kiosk stand, burners with placards, a laminated flip-book and several take-home brochures (replenished at no cost).



Flip Book Cover



Open Flip Book



Take-Home Brochures

Model	Name
KIOSK KIT	7' X 3'

## LITERATURE



Style	Name
LIT-BROCHURE OUTDOOR	Night Impressions
LIT- CATALOG OUTDOOR	Outdoor Product Catalog
LIT- WATER BROCHURE OUTDOOR	Fire Meets Water Brochure
LIT- KIOSK BROCHURE	Ignite the Night Brochure

## HPC DISPLAY STANDS

**FOR DISPLAY ONLY! NOT FOR OUTDOOR INSTALLATION**

Need to display your fire pit inserts? Our steel display stands give full access to the insert for your customer to look at every detail!

The fire pit insert displays are available as follows:

- 1) Push Button / Spark Ignition (FPPK) Display Kit- includes applicable FPPK fire pit insert, match lit insert control valve (327-CH) and the display stand.
- 2) Electronic Ignition (EI) Display Kit- includes applicable EI fire pit insert and the display stand.
- 3) Stand Only

Style	Round	Rectangle	Linear Trough	Linear- Interlink	Description
	DS25-ROUND-FPPK	DS30X12-HBURNER-FPPK	DS36-TRGH-FPPK	DS49X8-LINEAR-FPPK	Includes Push Button / Spark Ignition fire pit insert match lit valve, mounting sleeve & stand.
	DS25-ROUND-EI	DS30X12-HBURNER-EI	DS36-TRGH-EI	DS49X8-LINEAR-EI	Includes Electronic Ignition fire pit insert and display stand.
Stand Only	DS25-ROUND	DS30X12-HBURNER	DS36-TRGH	DS49X8-LINEAR	Includes stand only.



**DS25-ROUND-FPPK**  
For use with 25" Round Insert



**DS30x12-HBURNER-FPPK**  
For use with 30x12" H-Burner Insert



**DS36-TRGH-FPPK**  
For use with 36" Trough Insert

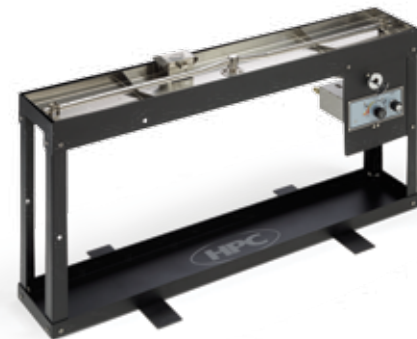

**DS49X8-LINEAR-FPPK**  
For use with 49"x8" Interlink Insert

## POINT OF PURCHASE BANNER



## BANNER KITS

48"x30" Banner for storefront display

Model	Description
BANNER KIT	Coroplast (Rigid Plastic Board)
BANNER KIT-OUTDOOR	Vinyl Outdoor Banner with grommets in the corners

**BANNER KIT and BANNER KIT-OUTDOOR**



FIRE INSPIRED™

**Inspired by safety.  
Innovated for your lifestyle.**