



Smart Cooking Machine

Item No.: GM-CM-128W

Model No.: SPM-128CSL



Thank you for choosing our product!

Congratulations on the purchase of your Smart Cooking Machine. It has been designed to help you quickly prepare and cook delicious meals.

To make sure you get the most out of this multi-functional Smart Cooking Machine, we recommend you read all the instructions, including the safety warnings, before using the product. For your own safety, please only use the product as described in this manual.

Keep the manual in a safe place so you can easily refer to it and pass it on to any future owners of the product.

Appliance symbols

	The appliance is made from food-safe materials that will not affect the taste or smell of food.
	Warning! The appliance may become extremely hot during operation. Do not touch hot surfaces.
	Warning! The appliance may release hot steam during operation.

Intended purpose

Your appliance is used to cook, chop, mix & blend, knead, weigh, boil & steam, grind, sauté, whisk, emulsify.

These user instructions describe the basic functions such as mixing, chopping and steaming. For information on the preparation of special dishes, refer to the recipe book included in the delivery.

The appliance is designed for private and domestic use only. The appliance must only be used indoors.

This appliance must not be used for commercial purposes.

Content

1. Safety Guide	5
1.1 For Your Safety	5
1.2 Signal Words	5
1.3 Hazards and Safety Instructions	5
2. Overview	13
3. Screen display	14
4. Functions overview	15
5. Items supplied	16
6. Before first use	16
7. Built-in scale	17
8. Operating the appliance	18
8.1 Power supply	18
8.2 Switching the appliance on and off	18
8.3 Electronic lock	18
8.4 Screen	19
8.5 Setting the time	19
8.6 Setting the temperature	19
8.7 Setting the speed	20
8.8 Reverse rotation	21
8.9 TURBO function	22
8.10 Overflow	22
8.11 Starting and stopping the appliance	22
9. Using the mixing bowl	22
9.1 Remove the mixing bowl	23
9.2 Markings inside the mixing bowl	23
9.3 Using and removing the blade	23
9.4 Inserting the mixing bowl	24
9.5 Insert and remove the butterfly whisk	25
9.6 Putting the lid on the mixing bowl	25
9.7 Using the measuring cup	26
9.8 Cooking and steaming with the simmering basket	26
9.9 Using the spatula	27
10. Steam mode	28
10.1 Steam mode preset	28
10.2 Setting up the steamer	28
10.3 Starting the steaming process	29
10.4 Checking the cooking status	30
10.5 Steaming with the simmering basket	30
10.6 Overheating protection	31
10.7 Using the steamer	31
10.8 One pot recipes	31

Content

11. Knead mode	31
11.1 Knead mode presets	31
11.2 Starting the kneading process	31
12. Sauté mode	32
12.1 Sauté mode preset	32
12.2 Starting the sautéing process	32
13. Cleaning	33
13.1 Cleaning the main unit	33
13.2 Cleaning in the dishwasher	33
13.3 Cleaning the accessories	34
13.4 Cleaning, checking and replacing seals	34
13.5 Cleaning, checking and replacing the spatula	35
13.6 Descaling	35
13.7 Storage	36
13.8 Replacing the blade socket	36
14. Troubleshooting	37
14.1 Malfunctions during operation	37
14.2 Error messages on the screen	39
15. Disposal	40
16. Technical specifications	40

1. Safety Guide

Foreseeable misuse

WARNING! Risk of material damage!

- Do not use the appliance to chop particularly hard food such as bones or nutmegs.

1.1 For Your Safety

Safety is an essential part of every Cooking Machine. However, the product safety of the Cooking Machine can only be ensured if this chapter and the warning notices in the following chapters are followed.

Do not attempt to operate the appliance without reading and understanding the user manual instructions to insure all safety measures and features are in place and operating correctly.

1.2 Signal Words

Be aware of the signal words **WARNING** and **NOTE** as they relate to safety notes. These are the signal words for the respective safety notes:

WARNING 

Indicates a hazardous situation which, if not avoided, could result in death or serious injury.

NOTE

Used to address best practices to avoid damage to your appliance, its accessories and potential injury.

1.3 Hazards and Safety Instructions

Risk of Electric Shock

If water penetrates the electrical components, you could receive an electric shock.

- Clean the main unit only with a dry or damp cloth.
- Do not pour water over the main unit.
- No water or dirt should enter the main unit.
- Unplug the main unit from the outlet.
- Do not use the appliance outdoors.
- Do not immerse the main unit in water or other liquids.
- Do not hold the main unit under running water.
- If water has managed to penetrate the main unit, unplug the main unit immediately from the electrical wall outlet. Contact the service center without delay. Do not attempt to operate your appliance.
- Always use caution when pouring food or liquids in or out to ensure the power cord and power socket stay dry.

Risk of Electric Shock

- An incorrectly installed power electrical wall outlet or the power socket may cause an electric shock.
- Only connect the appliance to an electrical wall outlet installed by a qualified specialist.
- Do not plug the power cord into an electrical outlet if it is wet or if the power socket is wet.
- As a matter of best practice, you should regularly check the plug, power socket and your electrical wall outlet for burn marks, sounds of ‘arcing’ (buzzing or crackling) as well as pay attention to fuses blowing or circuit-breakers tripping in relation to the electrical wall outlet you are using for your appliance.
- If your premises, or the electrical wall outlet to which your appliance is plugged in, is not equipped with a fusebox, circuit breaker box or electrical outlets with ground fault circuit interrupter (GFCI) protection, then you should ensure you use a plugin GFCI adapter in your selected electrical wall outlet and then plug your appliance into that GFCI adapter.

Risk of Electric Shock

If the main unit or power cord is damaged, you could receive an electric shock. Do not use the appliance if the power cord is damaged.

- Before every usage inspect the main unit, power cord and accessories for potential damage.
- Ensure that the power cord does not touch hot surfaces, external heat sources or sharp objects.
- Do not allow the power cord to be damaged by sharp objects such as knives, scissors, or the blade.
- Do not use the main unit if it is dropped or damaged in any manner.
- If the power cord on the main unit has been damaged, it must be replaced by the manufacturer or an authorized Repair Center.
- Never allow the main unit to be repaired by unauthorized third parties.
- Never put your fingers into the openings that are intended for the contact pins on the base of the mixing bowl. Do not insert any objects into these openings.

Fire Hazard

If the main unit is placed on a hot surface, it can catch fire or melt.

Do not place the main unit on a stovetop (conventional, ceramic glass, induction or other cooktop) or on any other heated surface.

- Keep the main unit away from hot surfaces.
- Ensure that the power cord does not touch hot surfaces or external heat sources.

Fire Hazard

The main unit has a high energy consumption. An insufficient power supply could cause a fire. Ensure that the circuit you are plugging into is rated appropriately.

- Please ensure power supply capacity is higher than 800W with 120V or 220-240V 60Hz according to your geographical region.
- Do not use multiple socket extension cords or other devices to connect the appliance to an electrical outlet.

Scalding Risk

Serious burns from hot liquids and steam may result from appliance being pulled off a countertop. Do not allow the cord to hang over the edge of the counter when it may be grabbed by children or become entangled with the user.

- Do not use the appliance with an extension cord.
- Do not drape the power cord over the edge of the counter.
- Do not connect the power cord to outlets below counter height.

Scalding Risk

If the hole in the mixing bowl lid is completely sealed and heating is active, excess pressure can build up in the mixing bowl. The hot contents may erupt from the appliance and cause scalding.

- To allow steam to escape and prevent excess pressure, ensure the hole in the mixing bowl lid is never blocked or covered – either from the inside (e.g. by food) or from the outside (e.g. by a towel).
- Never cover the hole in the mixing bowl lid with anything but the original accessories (measuring cup, simmering basket, steaming trays and lid).
- Do not fill the simmering basket above the maximum capacity (33.8 oz / 1 L).
- If the hole in the mixing bowl is blocked anytime during the cooking process, unplug the main unit immediately. Do not touch the controls.

Scalding Risk

Hot liquid or hot food may splash and cause scalding if it contacts the users skin or clothing.

- Do not fill the mixing bowl above the maximum fill line (2.3 QT / 2.2 L).
- Ensure that the hole in the mixing bowl lid remains free of food.
- Use only the included original accessories according to the accompanying user manual instructions (measuring cup, simmering basket, steaming trays, lid, blade and steamer seal) to prevent grease or liquid from splashing.
- Exercise caution when adding hot liquids to the mixing bowl.
- Be careful when removing the mixing bowl from the main unit to help prevent contents from spilling or splashing.
- Use only the designated handles and grips when lifting and pouring heavy contents from the mixing bowl.
- Never touch the stainless steel surface of the mixing bowl when the contents inside are hot as it may result in a burn injury.

Scalding Risk

When preparing larger quantities of food (deviation from the recipe) at high temperatures (> 194 °F / 90 °C), food can boil over, escape from the mixing bowl, and cause scalding.

- If contents boil over, unplug the cooking appliance from the electrical wall socket.

Scalding Risk

If the appliance is set to a high speed along with a high temperature, hot food could escape and cause burns.

- Do not use the Turbo mode for hot food or liquid over 140 °F / 60 °C.

Scalding Risk

Steam is generated during cooking, particularly when using the steaming trays and lid. Keep distance to ensure that the steam does not contact you to reduce the risk of burns and scalding from the steam.

- Keep away from the steam.
- Do not touch the measuring cup when processing hot food, do not cover the measuring cup.
- Ensure that steam can escape on the sides of the measuring cup.
- Ensure that some slots in the steaming trays and steaming lid remain free of food to allow the controlled escape of steam.
- When removing the steaming tray and lid, tilt the lid away from your face and body to avoid escaping steam.
- Keep your face away from the steam and do not reach over the steaming trays while it is in use as it may result in a burn injury.

Scalding Risk

The Sauté mode generates very hot grease. Water and oil mixtures may splatter, resulting in injury and increasing the potential risk of burns caused by the hot grease.

- Never pour hot grease into the mixing bowl.
- Never heat oil without other ingredients. If there is a delay in adding the ingredients, the hot oil will splatter excessively.
- Ensure all accessories are dry prior to usage.
- Follow the instructions on the display.

Scalding Risk

If the mixing bowl lid is not correctly positioned on the mixing bowl, hot contents can escape and lead to scalding.

- Never try to open the mixing bowl lid or the locking mechanism using force.
- Only open the lid when the cooking process is paused or completed.
- Inspect the steamer seal regularly for possible damage. In case of damage or leakage, replace the steamer seal immediately. Contact customer service for replacement parts.
- Only use the appliance with a clean mixing bowl lid. The rim of the bowl and the seal must always be free of adhering food to ensure a tight seal between the lid of the bowl and the mixing bowl.

Scalding Risk

A risk of burning injury is present when dealing with hot food in the simmering basket.

- Exercise caution when removing the simmering basket. Do not reach over the steam vents in the simmering basket
- Ensure that the spatula is hooked securely onto the simmering basket before removing the simmering basket.
- Once the simmering basket has been put down, remove the spatula to prevent the simmering basket from tipping over.

Scalding and Injury Risk

The main unit may be accidentally pulled by a hanging cable. The base unit could fall over and lead to scalding or other injuries.

- Do not let the power cord hang over the edge of a table or counter.

- Do not connect the main unit to an extension cord.

Injury Risk

To avoid fire, injury or electrical shock:

- Only use original accessories and parts;
- Never use non-original attachments, accessories or items;
- Do not use damaged attachments, accessories or items;
- Do not use incompatible accessories or parts.

Injury Risk

Other utensils, apart from the supplied spatula, could get caught in the blade and cause injury, if they are used to stir food in the mixing bowl when in motion.

- Do not place anything into the lid opening of the mixing bowl other than the original spatula, while it is in use. The spatula has a protective ring specifically designed to prevent it from contacting the blade. Placing accessories not supplied or recommended by the manufacturer into the lid opening during operation may result in serious injury and/or damage to the main unit.
- Do not cut off or otherwise alter the protective ring on the original spatula.

Injury Risk

The process of kneading dough or chopping food may cause the appliance to move or slide over the counter. The appliance could fall over and cause injury.

- Place the main unit on a clean, solid, and flat horizontal surface.
- Ensure that there is sufficient distance between the appliance and the edge of the work surface.
- Never leave the appliance unattended while it is running.

Injury Risk

If accessories get caught in the blade when the appliance is running, small splinters and sharp edges could cause injury.

- If any accessories are damaged by the blade during food preparation, discard the food and contact customer service for replacement of accessories.

Health Risk

- Ensure hygienic working practices at every stage of the food preparation and cooking process.
- Follow the instructions in the recipe precisely (temperature, speed, rotation and time).
- Once food has been cooked according to the instructions in the recipe, make sure that it is consumed immediately or that it is correctly preserved/stored.
- Ensure to clean the mixing bowl and all the accessories, including the blade seal and the steamer seal after each cooking process.

Health Risk

All of the accessories are designed specifically for use with the Cooking Machine. Incorrect use of the accessories could result in injury.

- Do not use the accessories for other purposes, particularly at high temperatures.
- Do not use the spatula in hot pots and pans.

- Should an accessory get damaged, stop using it and contact Customer service for a replacement part.

Burn Risk

When preparing hot food, the mixing bowl and the accessories that are used will also get hot. Hot surfaces can cause burns even after the heating process has ended.

- Handle the mixing bowl, blade and accessories with care, particularly during and after the preparation of hot food.
- Only use the designated handles and grips when handling all components.
- Allow the mixing bowl and the blade to cool sufficiently before dismantling the mixing bowl and removing the blade.

Injury Risk

The blade is sharp and can lead to injury, if handled improperly.

- Handle the blade with care.
- Your blade can get very hot after prolonged use, even if you have not been using the heating function. Use caution when touching or removing the blade after use and allow it to cool completely before touching or removing it.
- Never grasp the blade by the blade edges.
- Exercise caution when removing the blade to prevent it from falling out.
- Do not reach into the mixing bowl.
- Keep parts of the body and hair away from the blade.

Health Risk

Because of the manufacturing process, residues of oil or other contaminants may be on the components of the appliance. Those contaminants are not suitable for consumption and pose a health risk.

- Thoroughly wash all components and accessories that could come into contact with food, with warm water and dish soap before using the appliance for the first time.
- Make sure to thoroughly dry all washed components and accessories before use.

Damage Risk

Never place the appliance directly under furniture and fittings (shelving units, wall units or similar), while in use. Doing so may result in property damage or damage to the appliance.

- Ensure that there is sufficient clearance above and around the appliance, taking into account the additional height when using the steaming trays and lid.

Damage Risk

If the main unit is connected to an unsuitable power supply, it will get damaged.

- Only operate the appliance with the alternating current voltage of 114-126 V or 220-240V depending on your geographical region and main frequency of 50 to 60 Hz, as indicated on the plug label.

Damage Risk

The appliance can sustain damage if there is not enough water in the mixing bowl when boiling or steaming food.

- Make sure that there is sufficient water in the mixing bowl. Approximately 8.5 oz / 250 ml of water will evaporate in 15 minutes in the appliance.

- Add water as needed, especially if you have subsequently increased the steaming time. However, do not exceed the maximum capacity, marked MAX. inside the mixing bowl.

Damage Risk

If the mixing bowl and blade are in contact with water, other liquids or food residues for a long time, they could get damaged.

- Clean and dry the components shortly after use.
- Because of variations in water quality, it is also possible for rust to form in the mixing bowl when cooking food over a long period of time. Therefore, please follow the instructions on adding special ingredients (e.g. citric acid) to the cooking water.

Corrosion inside the appliance

Ensure that the mixing bowl and especially the contact pins underneath are thoroughly dried after cleaning. If you use the mixing bowl when it is still wet, rust could form inside the mixing bowl and the blade.

- Allow the mixing bowl to dry completely before inserting it into the base unit.

Damage Risk

If the blade is not correctly inserted and locked into place or the sealing ring is damaged, moisture can penetrate the appliance and damage the main unit.

- Ensure that the blade seal of the blade is fitted to the blade bearing.
- Ensure that the sealing ring on the blade shows no signs of damage.
- Ensure that the blade is correctly inserted and locked into place before filling the mixing bowl.
- If liquid leaks or spills into the housing of the main unit, unplug the appliance and contact customer service.
- Avoid cooking with bones as it may damage the blade.





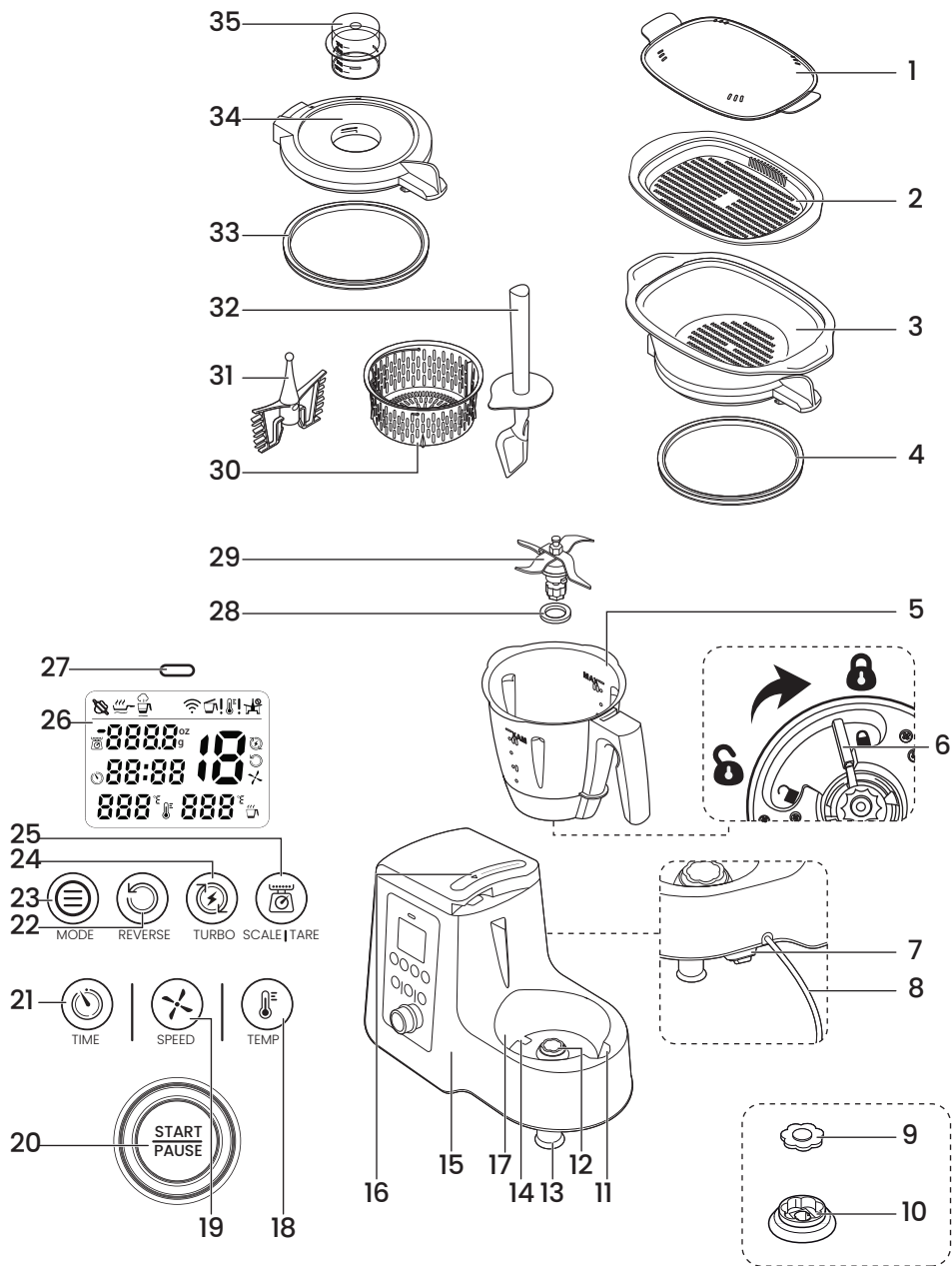

Damage Risk

If the butterfly whisk comes into contact with the blade or other accessories when the appliance is running, it could crack or break.

- Ensure that the butterfly whisk is correctly attached to the blade before setting the speed.
- Do not exceed speed 4 when using butterfly whisk.
- Do not use the spatula when the butterfly whisk is in place.
- Do not add any ingredients that could damage or block the butterfly whisk.



2. Overview

1		Steamer lid
2		Shallow steaming tray
3		Deep steaming tray
4		Steamer seal
5		Mixing bowl
6		Unlocking lever
7	O/I	Power switch
8		Power cable with plug
9		Silicone cover
10		Blade socket
11		Mixing bowl socket
12		Blade socket
13		Rubber feet
14		Overflow hole
15		Main unit
16		Locking position
17		Built-in scale
18		TEMP button
19		SPEED button
20	START/PAUSE	START / PAUSE button and SETTING dial
21		TIME button
22		REVERSE button
23		MODE button
24		TURBO button
25		SCALE / TARE button
26		Screen
27		Status LED
28		Blade seal
29		Blade
30		Simmering basket
31		Butterfly whisk
32		Spatula
33		Lid seal
34		Mixing bowl lid
35		Measuring cup

3. Screen display

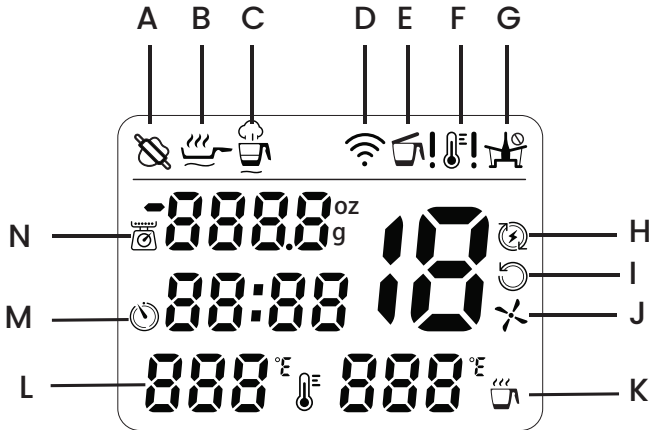



A  Knead mode

B  Sauté mode

C  Steam mode

D  Wi-Fi Connection Status

E  **Warning!** The mixing bowl is incorrectly inserted and / or the lid is not closed properly

F  **Warning!** The turbo function cannot be used because the contents in the bowl are too hot. The status LED turns red when the temperature is too hot to operate this function

G  Prohibition symbol appears when butterfly whisk cannot be used at speeds 5-10

H  Turbo function is in use

I  Reverse function enabled

J  Speed - flashes when you are in setting mode









K  Mixing bowl temperature

L  Temperature - flashes when you are in setting mode
100 °F - 265 °F
37 °C - 130 °C

M  Timer - flashes when you are in setting mode
1 second up to 90 minutes (depends on mode)

N  Scale measurement up to:
176.5 oz (+/- 0.1 oz) & 5000 g (+/- 5 g)

4. Functions overview

Button/Component	Function	Notes
MODE button  23	Select Knead, Sauté or Steam or custom mode	
	 Steam mode uses the steaming trays 2 and 3 to steam vegetables, fish and meat	Can also be used with the simmering basket 30
	 Knead mode	<ul style="list-style-type: none"> - A maximum of 17.6 oz / 500 g of flour can be processed - Do not use with the butterfly whisk 31
	 Sauté mode lightly browns food e.g., meat or onions	Small quantities, cut in pieces
SCALE / TARE button  25 / Built-in scale 17	<ul style="list-style-type: none"> - Weigh ingredients with +/- 0.1oz / 5g increments - The tare function resets the scale to 0 for additional ingredients to be weighed - Change the measurement unit 	Up to 176.5 oz / 5000 g
TEMP button  18 / SETTING dial 20	Set the cooking temperature	
REVERSE button  22	Reverse rotation	Can only be used at speed level 3 or below
TURBO button  24	Turbo increases the blade speed to the maximum level. It is useful for chopping nuts and small amounts of herbs or onions	<ul style="list-style-type: none"> - Function is blocked if the food temperature in the mixing bowl exceeds 145 °F / 60 °C - For liquids: up to 33.8 oz / 1L maximum - Do not use with the butterfly whisk 31

Button/Component	Function	Notes
Blade 29	To crush, chop and mix ingredients	<ul style="list-style-type: none"> - The blade must be inserted to seal the bottom of the mixing bowl - If necessary, cut ingredients first in 3 - 4 cm / 1.18 - 1.57 inches pieces
Butterfly whisk 31	For liquid ingredients: <ul style="list-style-type: none"> - To whip cream (at least 6.7 oz / 200 ml) - To whip egg whites (at least 2 eggs) - To emulsify (e.g., mayonnaise) 	<ul style="list-style-type: none"> - Should only be used with speed settings from 1 to 4 - Must not be used with the turbo function
Simmering basket 30	To cook and stew	Fill the mixing bowl with at least 16.8 oz / 500 ml of water

5. Items supplied

- 1 "Cooking Machine", main unit **15**
- 1 mixing bowl **5** with:
 - blade **29**
 - mixing bowl lid **34**
 - measuring cup **35**
- 1 simmering basket **30**
- 1 butterfly whisk **31**
- 1 spatula **32**
- 1 steamer, comprising:
 - deep steaming tray **3**
 - shallow steaming tray **2**
 - steamer lid **1**
- 1 copy of the user instructions
- 1 recipe book

6. Before first use

Prior to the first use, operate the appliance only with water so that any residues can evaporate. Wash thoroughly all accessories with soap.

NOTE: when in operation for the first time, some odour may be generated by the appliance. This is harmless. Please ensure adequate ventilation.

1. Remove all packing material.
2. Check to ensure that all parts are present and undamaged.
3. **Clean the appliance prior to its first use!** (see "Cleaning and Maintenance" on page 33).
4. Use the mixing bowl **5** to bring 2.2 L or 2.3 QT of water to a boil once, pouring it away afterwards (see "Setting the temperature" on page 19).
5. Place the main unit **15** on a level, dry, non-slip and waterproof surface, so that it can neither fall nor slip off.

WARNING!

- Overflowing liquid may escape onto the surface. You should therefore place the appliance on a waterproof surface.

7. Built-in scale

The installed kitchen scale allows accurate weighing with +/- 0.1 oz or 5 g increments and weighs up to 176.5 oz / 5000 g.

The scale **17** is easy to operate and ready for use unless another mode is in operation.

Easy weighing

NOTE: the bowl needs to be properly installed in the main unit. The lid doesn't need to be locked in for the weighing function but the bowl needs to be in place.



1. Make sure the appliance is on and no other function is in operation.
2. Press the **SCALE / TARE** button  **25**. The screen **26** shows 0000 oz / g.



3. Place the object to be weighed inside the mixing bowl **5**. On the screen **26**, the weight will be shown in ounces or grams up to a maximum of 176.5 oz or 5000 g.
4. Remove the weighed ingredient from the mixing bowl **5**.
5. Press the **MODE** button  **23** to exit the weighing function.

Weighing with tare function

The tare function enables you to reset the weight on the built-in scale to zero. This function is useful when you want to measure an ingredient and not include the weight of the bowl, or when you want to weigh multiple ingredients individually as you place them into the same bowl.

1. Make sure the appliance is on and no other function is in operation.
2. Press the **SCALE / TARE** button  **25**. The screen **26** shows 0000 oz / g.
3. Place the empty bowl on the scale **17**. The bowl's weight will display.
4. Press the **SCALE / TARE** button  **25** to reset the weight to zero (0000 oz / g).
5. Place the ingredient you want to weigh in the mixing bowl **5**. The weight of this ingredient will display on the screen **26**.
6. Repeat steps 4 and 5 to weigh additional ingredients into the mixing bowl **5**.
7. Press the **MODE** button  **23** to exit the weighing function.

NOTE: If the weight exceeds 176.5 oz / 5000 g, - - - appears on the screen.

Changing the measurement unit

- In the custom mode, press and hold the **SCALE/TARE** button  **25** to change the measurement unit from grams to ounces or vice versa.

8. Operating the appliance

For safety reasons the settings described in this chapter, can only be selected when the mixing bowl is properly installed in the main unit and the mixing bowl lid **34** or steamer are correctly installed.

8.1 Power supply

- Plug the power cable **8** into a suitable wall socket. The wall socket must continue to be easily accessible after the appliance is plugged in.

8.2 Switching the appliance on and off

- Set the power switch **7** on the rear to **I** to switch on the appliance.
 - The screen **26** will light up, briefly shows the full screen display and an audio signal sounds. Then, the appliance enters custom mode. All adjustable values are set to 0 and the current temperature of the mixing bowl will display.

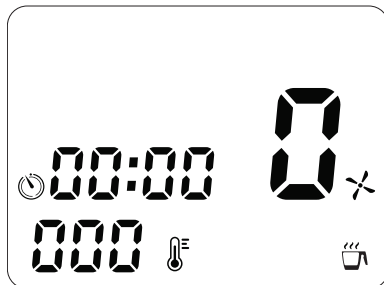

- Set the power switch **7** on the rear to **O** to switch off the appliance.

8.3 Electronic lock

This food processor has an electronic lock that is connected when the mixing bowl lid **5** or the deep steaming tray **3** are correctly installed. This is a safety function so the lid cannot be opened easily when the blade **29** is turning.

- This lock is always activated when the appliance cooking program is in use.
- After the appliance stops, the lock still remains activated for 1-2 seconds.
- An audio signal sounds and the mixing bowl lid **34** or the deep steaming tray **3** can be opened.
- The higher the speed the longer the lock stays active, since the blade **29** and the food keep turning longer.

8.4 Screen

- The screen **26** shows all settings and operating values.
- After approximately 5 minutes without any user interaction, the illumination of the screen **26** goes into sleep mode. As soon as any button is pressed or a dial is turned, the illumination of the screen **26** is switched on again for 5 minutes.

8.5 Setting the time

You can adjust the time in all modes.

1. Press the **TIME** button  **21** to set the cooking time.
 2. Turn the **SETTING** dial **20** clockwise to increase the time.
 3. Turn the **SETTING** dial **20** counterclockwise to decrease the time.
- You can adjust the timer from 1 second to 90 minutes. The timer setting will count up as follows:

From	To	Time unit
1 second	1 minute	In seconds
1 minute	10 minutes	In 30-second intervals
10 minutes	90 minutes	In minutes

- The time set is shown on the screen **26**.



- The time is counted down after the program has started in all modes.
- If no time and no temperature are specified, the time display will count up the time from 0 seconds (00:00) to 90 minutes (90:00) while the blade is in operation. Then, the appliance will be stopped automatically.
- During operation, the time can be adjusted.
- When the countdown is finished, the appliance stops.
- After several seconds, an audio signal sounds.
- The mixing bowl lid **34** can be opened.
- The timer can be used solely as a timer when the temperature or speed settings are not set or in use.

NOTE: If the speed setting is higher than 6 and you set a time exceeding 15 minutes, the time will automatically be decreased to 15 minutes.

8.6 Setting the temperature

1. Press the **TEMP** button  **18** to set the cooking temperature.
2. Turn the **SETTING** dial **20** clockwise to increase the temperature.
3. Turn the **SETTING** dial **20** counterclockwise to decrease the temperature.
 - The adjustable temperature ranges from:
 - 37 °C to 130 °C
In increments of 37, 45, 50, 55, 60, 65, 70, 75, 80, 85, 90, 95, 100, 105, 110, 115, 120, 125, 130 °C
 - 100 °F to 265 °F
In increments of 100, 115, 125, 135, 145, 150, 160, 170, 180, 190, 195, 205, 212, 220, 230, 240, 250, 255, 265 °F
 - The set temperature is shown on the screen **26**.

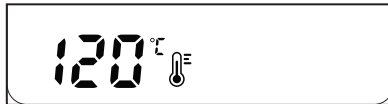

- To start the heating process, a speed and time setting must be entered.
- During the heating process, the mixing bowl temperature may vary substantially.
- The set temperature appears on the bottom left of the screen while the current temperature appears on the bottom right of the screen.

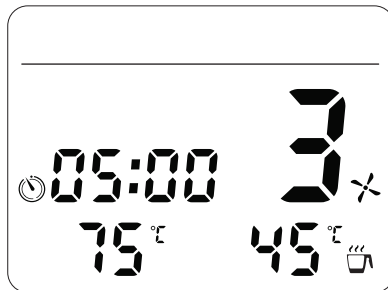

- During operation, the set temperature can be changed.

NOTE: If a speed is set above 3, the heating function is deactivated and the temperature cannot be adjusted.

Changing the temperature unit

- In custom mode, press the **TEMP** button  **18** and then press and hold the **TEMP** button  **18** to change the measurement unit from Celsius to Fahrenheit or vice versa.

8.7 Setting the speed

Press the **SPEED** button  **19** to set the speed:

- The speed can be adjusted in 10 increments.
- Speed 1 - 4: The butterfly whisk **31** can only be used at these 4 speeds. When the temperature value is selected, the max speed is 3.

WARNING!

- The butterfly whisk **31** must only be used with speed settings 1 to 4. On the screen **26**,  appears if you set a level above 4.
- When mixing liquids at speed 10, the mixing bowl **5** must not contain more than 33.8 oz / 1 L, otherwise liquid might be ejected (see "Using the mixing bowl" on page 22). For speed settings of less than 10, the mixing bowl **5** may only be filled up to a maximum of 2.2L or 2.3 QT.

- For further notes: see "Functions in an overview" on page 15.
- The set speed is shown on the screen **26**.



- During operation, the speed setting can be adjusted.
- The speed cannot be set in the Steam mode .
- If a temperature has been selected, only the speed settings 1 - 3 are available.

Soft start

The soft start function is built-in to the appliance and is automatically activated when the mixing bowl temperature exceeds 145°F / 60 °C. It prevents hot liquid being ejected from the mixing bowl **5**. The soft start is used for all settings except the turbo function.

8.8 Reverse rotation

The reverse function can be used to change the blade's direction and gently stir food with the blunt side of the blade instead of cutting it.

- The reverse function can only be applied at low speed settings 1 to 3.
- Press the **REVERSE** button  **22** to reverse the blade to stir food.

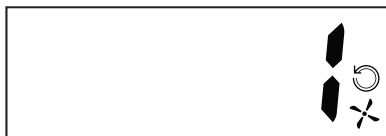

- Press the **REVERSE** button  **22** again to change the blade direction back to cutting food.

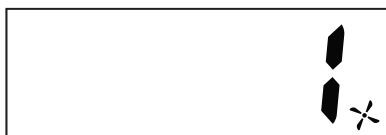

8.9 TURBO function

WARNING!

- When mixing liquids, the mixing bowl **5** must not contain more than 33.8 oz / 1 L, otherwise the liquid might spill out.
- Never use this function when the butterfly whisk **31** is attached to the bowl.

The turbo function is a fast way to increase the speed to the high level (equivalent to speed 10) in short bursts. It is used to quickly chop nuts or small amounts of herbs or onions.

NOTE: the Turbo function will only work if the mixing bowl temperature is less than 145°F / 60 °C. If it is higher than 145 °F / 60 °C an audio signal will sound and the turbo function will be disabled. If you press the **TURBO** button  **24** there will be no response and an alert will sound.

- Press and hold the **TURBO** button  **24** for as long as you need the turbo function.



8.10 Overflow

In the bottom of the main unit **15** there is an overflow hole **14**.

Should liquid spill out of the mixing bowl **5**, it can escape via the overflow hole **14** onto the kitchen countertop.

8.11 Starting and stopping the appliance

- When you selected your settings, press the **START / PAUSE** button **20** to turn on the appliance.
- Press the **START / PAUSE** button **20** to pause an operation.
- Press and hold the **START / PAUSE** button **20** to completely stop an operation.

NOTE: if you only enter the temperature as a setting, nothing will happen. You need to select the speed and time before starting the program.

9. Using the mixing bowl

NOTE: these user instructions describe the basic functions such as mixing, chopping and steaming. For information on the preparation of special dishes refer to the included recipe book.

9.1 Remove the mixing bowl

The mixing bowl **5** can only be removed if the mixing bowl lid **34** is opened.

1. Turn the mixing bowl lid **34** counterclockwise until the arrow of the locking position **16** points to the open lock symbol .
2. Lift the mixing bowl **5** vertically upwards out of the mixing bowl socket **11**.

9.2 Markings inside the mixing bowl

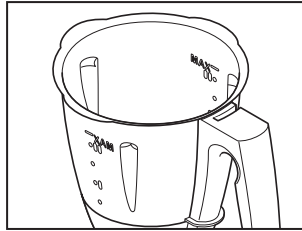

Inside the mixing bowl **5**, there are capacity markings:

- 16.8 oz / 0.5 L
- 33.8 oz / 1 L
- 50.7 oz / 1.5 L
- 67.6 oz / 2 L
- 74.4 oz / 2.2 L

WARNING!

- When mixing liquids at speed 10 or with the turbo function, the mixing bowl **5** must not contain more than 33.8 oz / 1 L, otherwise liquid may be ejected. For speed settings of less than 10, the mixing bowl **5** may be filled up to a maximum of 2.2 L or 2.3 QT.

NOTE: For some modes, the mixing bowl **5** should contain a sufficient amount of liquid so that the appliance can function properly. For whipping cream, you should use at least 6.7 oz / 200 ml and when beating egg whites use at least two eggs.

9.3 Using and removing the blade

The blade **29** is used to chop or stir food.

The mixing bowl **5** must never be used without the blade **29**. The blade **29** acts as a seal between the mixing bowl **5** and the main unit **15**.



WARNING! Risk of cut injury!

- The blades are very sharp.
- Never touch the blades with your bare hands.
- Never hold the blade by the sharp edges.
- Never turn the bowl upside down when removing the blade.

To remove the blade **29**, proceed as follows:

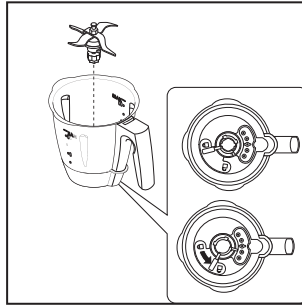

1. Position the mixing bowl **5** horizontally.
2. Press the unlocking lever **6** on the bottom of the mixing bowl **5** so that it points to the open lock symbol .
3. Pull out the blade by holding the center **29** carefully towards the top.

To insert the blade **29**, proceed as follows:

1. Position the mixing bowl **5** horizontally.
2. Insert the blade **29** from the top.
3. Make sure that the bottom part of the blade **29** is pushed through the recess in the underside of the mixing bowl **5** and is firmly locked into place.

WARNING!

- Ensure that the seal **28** for the blade **29** is positioned correctly, otherwise the content may escape.

4. To lock the blade **29**, move the unlocking lever **6** on the bottom of the mixing bowl **5** so that it points to the closed lock symbol .

NOTE: Chop large pieces into 3 to 4 cm (1.1 to 1.5 inches) cubes to avoid larger pieces getting stuck in the blades.

9.4 Inserting the mixing bowl

1. Place the mixing bowl **5** into the mixing bowl socket **11**.
2. Press the mixing bowl **5** downwards gently until the flower-shaped hub of the blade **29** engages with the blade socket **12**. You may need to wobble the mixing bowl **5** slightly so that it fits correctly.

NOTES: Should the mixing bowl **5** not be positioned correctly, a safety mechanism prevents the functioning of the appliance.

9.5 Insert and remove the butterfly whisk

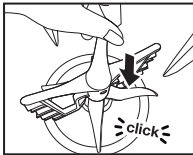

The butterfly whisk **31** combines liquid foods and it can whip cream, beat egg whites and emulsifying ingredients such as when making mayonnaise.

The butterfly whisk **31** is put onto the blade **29** as follows:

- The wings of the butterfly whisk **31** are located in the spaces between the blades.
- For further notes: see "Functions in an overview" on page 15.

WARNING!

- The butterfly whisk **31** must only be used with speed settings 1 - 4.
- The TURBO button **24** must not be pressed if the butterfly whisk **31** is used.
- When using the butterfly whisk **31**, the spatula **32** must not be used as it may get caught in the butterfly whisk **31**.
- When adding food, ensure that it will not block the butterfly whisk **31**.

Pull the butterfly whisk **31** upwards to remove it.

9.6 Putting the lid on the mixing bowl

The mixing bowl lid **34** can only be placed on if the mixing bowl **5** was inserted correctly.

1. Align the open lock symbol  on the mixing bowl lid **34** with the arrow on the main unit **15**.

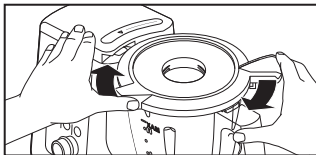

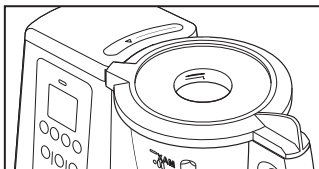

2. Press and turn the mixing bowl lid **34** clockwise with both hands until the closed lock symbol  points to the arrow of the locking position **16**.



Only when the mixing bowl lid **34** is correctly closed can the appliance start.

NOTES:

- To facilitate the closing of the lid, put a few drops of oil on a cloth and rub it on the seal **33**.
- The appliance can only be started when the mixing bowl lid **34** is locked into place correctly.
- To make the mixing bowl lid **34** properly lock in place, it is helpful to press lightly on the lock symbol  while closing the lid.
- If the mixing bowl lid **34** has not been put on correctly, the symbol  will appear on the screen **26**.
- When the appliance is started, the mixing bowl lid **34** is automatically locked.
- The statusLED **27** is blue when the lid is closed and red when it is open (see "Electronic lock" on page 18).

9.7 Using the measuring cup

The measuring cup **35** is used to close the lid of the mixing bowl **5**. It can be removed to add ingredients to the mixing bowl and as a measuring cup.

- To close the mixing bowl **5**, place the measuring cup **35**, with the opening at the bottom, into the mixing bowl lid **34** and turn clockwise to lock it in place.

WARNING!



Prior to removing the measuring cup **35**, you must reduce the speed setting 1, 2 or 3, so that no food can spill out.

- To add ingredients, the measuring cup **35** can be removed briefly.
- To measure ingredients, turn the measuring cup **35** upside down and add the food. The values can be read in ml or oz from the outside.

9.8 Cooking and steaming with the simmering basket

1. Fill at least 16.8 oz / 500 ml of water into the mixing bowl **5**. Only fill so much water into the mixing bowl **5** that the maximum filling volume of 2.2 L / 2.3 QT will not be exceeded when the food is added.
 - If the entire food is covered by water, it will be cooked.
 - If the food is not completely covered by water, it will be steamed.
2. Place the food into the simmering basket **30**.

NOTE: Always make sure that the filling level does not exceed the maximum capacity.

3. Place the simmering basket **30** into the mixing bowl **5**.
4. Close the mixing bowl **5** with the mixing bowl lid **34** and the measuring cup **35**.
5. Use the power switch **7** to switch on the appliance.
6. Use the **TIME** button  **21** to set the time.
7. Use the **TEMP** button  **18** to set the desired temperature, e.g., 212 °F / 100 °C for cooking. The screen **26** shows the time set and the selected temperature.



8. Select the speed setting 1 for an even distribution of the heat in the water.
9. Press the **START / PAUSE** button **20**. The appliance starts to operate.
10. When the countdown is finished, the appliance stops.
11. After several seconds an audio signal sounds. The lid can be opened.
12. Press the power switch **7** to switch off the appliance.

9.9 Using the spatula

The spatula **32** is used to stir the ingredients and to remove the simmering basket **30**.

WARNING!

- The spatula **32** must not be used when the butterfly whisk **31** is in place. Otherwise, the spatula **32** might be caught in the butterfly whisk **31**.
- Do not use any other kitchen utensil to stir the ingredients. The utensil might get into the blades and cause damage.
- Always stir clockwise. The spatula **32** is designed so that when stirring clockwise it cannot come into contact with the blade **29** when it is running.

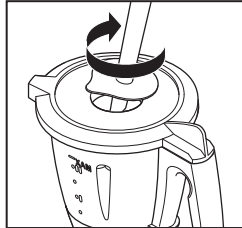

The hook on the rear of the spatula **32** can be used to remove the hot simmering basket **30** without having to touch it directly. Simply hook on the metal bracket of the simmering basket **30** and pull it out upwards.

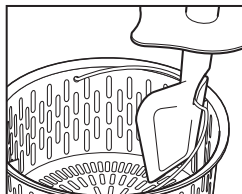

10. Steam mode



WARNING! Risk of burn injury!

- When opening the lid 1 or 34 during operation, hot steam may escape.

NOTE: these user instructions describe the basic functions such as mixing, chopping and steaming. For information on the preparation of special dishes, refer to the recipe book included in the box.

10.1 Steam mode preset

- Preset time: 20 minutes (adjustable).
- To skip the preheating process and directly proceed to steam, press the **START / PAUSE** button 20.
- If the mixing bowl 5 temperature reaches 205 °F / 95 °C, it will automatically activate and start the steamer countdown.

10.2 Setting up the steamer

1. Place the mixing bowl 5 onto the main unit 15.
2. Fill 33.8 oz / 1 L of water into the mixing bowl 5. This corresponds with the second marking from the bottom (I).

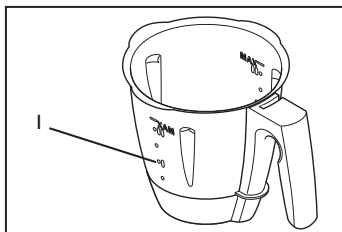

3. Check that the seal 4 of the deep steaming tray 3 has been installed correctly.
4. Put the deep steaming tray 3 slightly twisted onto the mixing bowl 5.

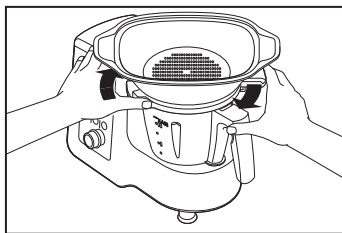

5. Turn the deep steaming tray 3 so that it locks safely into place. The appliance can only be started when the steaming tray 3 is fixed correctly.

NOTE: if the deep steaming tray **3** has not been put on correctly, the symbol  will appear on the screen **26**.



6. Place food into the deep steaming tray **3** and shallow steaming tray **2**.

NOTE: even if you only need the shallow steamer tray **2**, both steaming trays **3** and **2** must be inserted all the time, so that no steam can seep out of the lid seal.

7. Place the filled shallow steaming tray **2** on deep steaming tray **3**.

8. Close the steamer with the lid **1**.

10.3 Starting the steaming process

1. Use the power switch **7** to switch on the appliance.
2. Press the **MODE** button  **23** repeatedly until the symbol  appears on the screen **26**.
3. Press the **START / PAUSE** button **20** to begin pre-heating the appliance.

During this time

- There is no countdown of the time on the screen **26**.
- **PrE** will display on the screen when the heating process starts.
- The **TIME** button  **21** can be used to change the preset time.
- The electronic lock is activated.

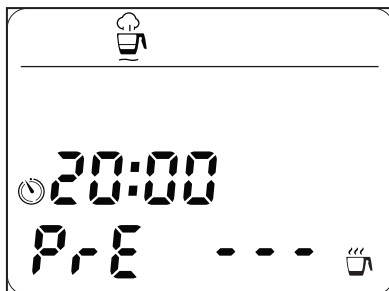

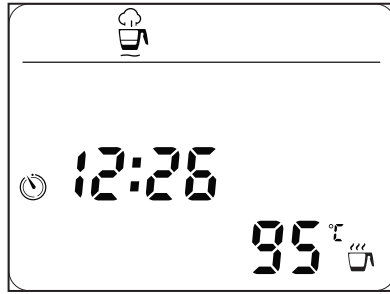

4. After the temperature reaches 205 °F / 95 °C a short audio signal sounds and the countdown begins.

NOTE: To start the Steam mode, press the **START / PAUSE** button **20** once.

5. When the timer counts down to 0, the cooking program is stopped and the lid can open.
6. Press the power switch **7** to switch off the appliance.



WARNING! Risk of injury through scalding!

- When opening the lid **1** or **34** during operation, hot steam may escape.

7. Remove the food from the steamer.

10.4 Checking the cooking status

Periodically check the cooking to make sure that the vegetables are not too soft, and the meat and fish are not dry and tough.



WARNING! Risk of burn injury!

- When opening the lid **1** during operation, hot steam may escape.

To check the condition of the food to be cooked from time to time, proceed as follows:

1. Carefully open the steamer lid **1** to let the steam escape.
2. Remove the lid **1** completely.
3. Check the food condition with a knife or fork:
 - When the food is cooked, press the **START / PAUSE** button **20** and then the power switch **7** to turn off the appliance, or press and hold the **START / PAUSE** button **20** to completely stop the program.
 - If the food is not quite cooked, place the lid **1** back, the cooking program will resume automatically.

10.5 Steaming with the simmering basket

1. Fill 16.8 oz / 500 ml of water into the mixing bowl **5**.
2. Place the food into the simmering basket **30**.
3. Place the simmering basket **30** into the mixing bowl **5**.
4. Close the mixing bowl **5** with the mixing bowl lid **34** and the measuring cup **35**.

5. Use the power switch **7** to switch on the appliance.
6. Start the program (see "Starting the steaming process" on page 29).
7. When the program comes to an end, open the mixing bowl lid **34** and remove the simmering basket **30** (see "Using the spatula" on page 27).
8. Press the power switch **7**, to switch off the appliance or move to the next step in the recipe.

10.6 Overheating protection

The appliance has an overheating protection system. As soon as there is no water left in the mixing bowl **5** the appliance will automatically stop the program to prevent the appliance from overheating. Pull out the power plug **8** and allow the appliance to cool. You may then add water to the appliance and start using it again.

10.7 Using the steamer

You can either use just the deep steaming tray **3** or both steaming trays **2** and **3**. The shallow steaming tray **2** cannot be used without the deep steaming tray **3**.

10.8 One pot recipes

If you prepare a whole menu and are using both steaming trays, please make sure that:

- Meat and fish are in the deep steaming tray **3**, so that dripping juice will not come into contact with other food.
- Denser food generally takes the longest to cook and should be placed in the deep steaming tray **3**.

11. Knead mode



The appliance can be used to process up to a maximum of 17.6 oz / 500 g of flour. The Knead mode is only operated with the blade **29**.

11.1 Knead mode presets

- Preset time: 1:30 minutes (adjustable).
- Maximum time: 3 minutes.

11.2 Starting the kneading process

NOTE: to prevent the appliance from overheating, do not run the Knead mode for more than 2 minutes for each kneading session. Allow the appliance to cool for at least 10 minutes before the next use.

1. Fill the dough quantity into the mixing bowl **5**.
2. Close the mixing bowl **5** with the mixing bowl lid **34**.
3. Use the power switch **7** to switch on the appliance.
4. Press the **MODE** button  **23** repeatedly until the symbol  appears on the screen **26**.



5. Press the **START / PAUSE** button **20**.

The Knead mode is started. The set time is counted down on the screen **26**. The Knead mode automatically controls the clockwise/reverse function.

6. After the set time is finished, the screen **26** shows all the values at 0 and an audio signal sounds.
7. The lid can be opened.
8. Press the power switch **7**, to switch off the appliance or move to the next step in the recipe.

12. Sauté mode



With this mode, you can sauté up to 7 oz / 200 g of meat, fish and vegetables. Large pieces must be cut into smaller 2 - 3 cm / 0.78 - 1.18 inches pieces.

12.1 Sauté mode preset

- Preset temperature: 130 °C / 265 °F (non-adjustable).
- Maximum time: 14 minutes.



12.2 Starting the sautéing process

1. Add oil or butter to grease the mixing bowl **5** surface.
2. Add ingredients into the mixing bowl **5**.
3. Close the mixing bowl **5** with the mixing bowl lid **34**.
4. Use the power switch **7** to switch on the appliance.
5. Press the **MODE** button  **23** repeatedly until the symbol  appears on the screen **26**.
6. Press the **TIME** button  and then turn the dial to set the desired value. Press the **START / PAUSE** button **20**.

The Sauté mode is started. The time set is counted down on the screen **26**. The Sauté mode automatically controls the reverse function. At a fixed interval, the blade **29** starts for a brief counterclockwise rotation.

7. The lid can be opened.
8. Press the power switch **7**, to switch off the appliance or move to the next step in the recipe.

13. Cleaning



WARNING! Risk of electric shock!

- Disconnect the main plug **8** from the wall socket before any cleaning.
- Never immerse the main unit **15** in water.



WARNING! Risk of cut injury!

- The blades are very sharp.
Never touch the blades with your bare hands, to avoid cuts.
- Before removing the blade **29**, rinse the mixing bowl **5** with water and remove scraps of food from the blades so that the blade **29** can be removed safely.
- When washing manually, the water should be sufficiently clear so that you can see the blade **29** easily to avoid injuries caused by the very sharp blades.

WARNING!

- Never use any abrasive, corrosive or scratching cleaning agents. These might damage the appliance.

13.1 Cleaning the main unit

1. Clean the outside of the main unit **15** with a damp cloth. You can also use soft detergent.
2. Use clear water and wipe with a clean cloth.
3. Do not use the main unit **15** until it is completely dry again.

13.2 Cleaning in the dishwasher

The following parts are dishwasher-safe:

- Steamer lid **1**
- Shallow steaming tray **2**
- Deep steaming tray **3**
- Steamer seal **4**
- Mixing bowl **5**
- Seal for blade **28**
- Blade **29**
- Simmering basket **30**
- Butterfly whisk **31**
- Spatula **32**
- Lid seal **33**
- Mixing bowl lid **34**
- Measuring cup **35**

Never use a dishwasher to clean the following parts:

- Main unit **15**

NOTE: before cleaning the mixing bowl **5** in the dishwasher, always remove the blade **29**.

Before every cleaning, remove the blade seal **28** from the rest of the blade **29**.

- Place plastic accessories on the top rack of the dishwasher to avoid deformation from the hot water and pressure.

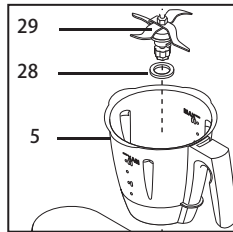

13.3 Cleaning the accessories

1. Rinse the mixing bowl **5** with warm water and dump the water.
2. Remove the blade **29** (see "Using and removing the blade" on page 23) and take the seal **28** off (see "Cleaning, checking and replacing seals" on page 34).
3. Clean all accessories by hand in a sink with water or in the dishwasher.
4. When cleaning by hand, rinse all parts with clean water.
5. Allow the parts to dry completely before using them again.
6. Before using the appliance again, reinsert the blade **29**.

13.4 Cleaning, checking and replacing seals

Remove seals **28**, **33** and **4** for cleaning and check them for damage. Pay attention to changes (e.g. porous material or tears).

- The removed seals **28**, **33** and **4** can be cleaned in the dishwasher.
- Damaged seals **28**, **33** and **4** must be replaced with new ones.

WARNING!

- Prior to the next use, damaged seals **28**, **33** and **4** must be inserted again or replaced with new ones. The operation without seals **28**, **33** and **4** in place is not permitted.

Blade **29**

1. Remove the blade **29** from the mixing bowl **5** (see "Using and removing the blade" on page 23).
2. Pull seal **28** off the blade **29**.
3. Insert the cleaned seal or a new one.
4. Before using the appliance again, reinsert the blade **29**.

Deep steaming tray **3**

1. Pull seal **4** off the underside of the deep steaming tray **3**.
2. Insert the cleaned seal **4** or a new one in the deep steaming tray **3**. Ensure that the seal is in continuous contact with the surface without any damage.

Lid of the mixing bowl 34

1. Pull seal 33 off the underside of the lid of the mixing bowl 34.
2. Insert the cleaned seal 33 or a new one in the lid for the mixing bowl 34.

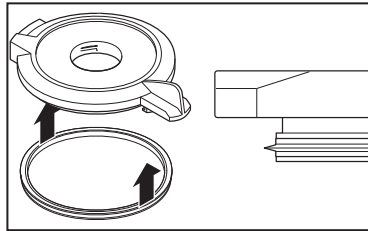

13.5 Cleaning, checking and replacing the spatula

The spatula 32 is provided with a detachable silicone scraper.

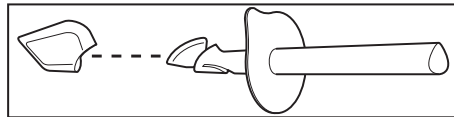

For cleaning, remove the silicone scraper, and check it for damage. Pay attention to changes (e.g. porous material or tears).

- Both parts can be cleaned in the dishwasher.

13.6 Descaling

When steaming with hard water, limescale may build up on the parts used, especially in the mixing bowl 5.

Normal cleaning

In most cases, the limescale deposits can be removed by cleaning in the dishwasher or by hand.

Slight limescale deposits

1. Remove slight limescale deposits, which cannot be removed with normal cleaning by hand or in the dishwasher, with a cloth on which you put some household vinegar.
2. Rinse with clear water.

Major limescale deposits

WARNING!

- Do not use commercially available descaling agent, not even glacial acetic acid or vinegar essence.

1. Prepare a mixture of 50% white household vinegar and 50 % boiling water.
2. Fill this mixture into the mixing bowl 5 or put other furred-up parts into a container with this mixture.
3. Allow the mixture to react for 30 minutes.

NOTE: more extended reaction periods do not improve the limescale deposits but may damage the parts permanently.

4. Rinse with clear water.
5. Allow the parts to dry completely before using them again.

13.7 Storage

- Store the appliance protected against dust and dirt and out of the reach of children.

13.8 Replacing the blade socket

If you process larger quantities than those specified in these instructions (e.g. dough with more than 17.6 oz / 500 g of flour), the blade socket **12** can become so worn out that the blade **29** no longer turns correctly.

If this happens, replace the blade socket **12** with a new one. Comply the specified maximum quantities in future.

Removing the old blade socket

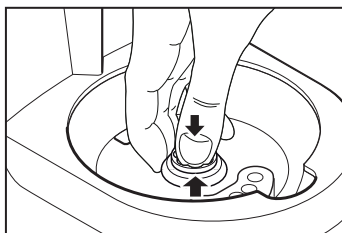

1. Press your thumb down on the silicone cover **9** and simultaneously reach under the rim of the old blade socket **12**. Pull the old blade socket **12** out upwards. You may need to “wobble” it a bit before the blade socket **12** becomes loose enough to be removed.

Inserting the new blade socket

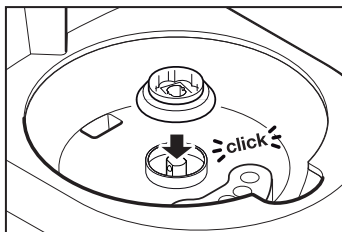

2. Place the new blade socket **10** onto the drive axle. The recess in the blade socket **10** needs to be inserted to match the flattened sides of the drive axle. The blade socket **10** clicks into place on the drive axle.

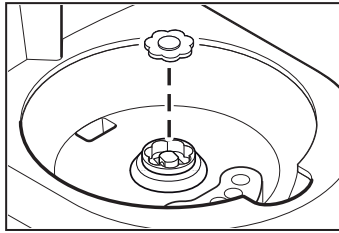

- Insert the silicone cover **9** into the blade socket **10**.

14. Troubleshooting

If your appliance fails to function as required, please try this checklist first. Perhaps there is only a minor problem, and you can solve it yourself.



WARNING! Risk of electric shock!

- Do not attempt to repair the appliance yourself under any circumstances.



14.1 Malfunctions during operation

Problem	Cause	Solution
Appliance does not start.	Mixing bowl 5 is not positioned correctly.	Insert mixing bowl 5 correctly (see "Inserting mixing bowl" on page 24).
	The mixing bowl lid 34 or deep steaming tray 3 have not been placed correctly onto the mixing bowl 5 .	Place the mixing bowl lid 34 or deep steaming tray 3 correctly.
	No power supply.	Check the main plug 8 , the power switch 7 and possibly the fuse.
Blade 29 not turning.	The blade socket 12 has worn out.	Replace the blade socket 12 with a new one and comply with the specified maximum quantities in future. This might be caused by processing too large quantities.

Problem	Cause	Solution
Liquid underneath the appliance.	The blade 29 has not been inserted correctly so that the mixing bowl 5 leaks.	Insert blade 29 correctly (see "Using and removing the blade" on page 23).
	Seal 28 for the blade is defective.	Insert new blade seal 28 (see "Cleaning, checking and replacing seals" on page 34).
	Liquid spilled out from the mixing bowl 5 flowing onto the surface through the overflow hole 14 of the main unit 15 . (See "Overflow" on page 22.)	When mixing liquids at speed 10 or on turbo, the mixing bowl 5 must not contain more than 33.8 oz / 1 L, otherwise liquid may spill out. For speed settings of less than 10, the mixing bowl 5 may be filled up to a maximum of 2.2 L / 2.3 QT.
Liquid escapes through the mixing bowl lid 34 on the mixing bowl 5 .	Seal 33 has not been inserted correctly.	Insert seal 33 correctly (see "Cleaning, checking and replacing seals" on page 34).
	Seal 33 is defective.	Insert new seal 33 (see "Cleaning, checking and replacing seals" on page 34).
No temperature can be set.	User is not in a custom mode and is using a preset mode.	Press the MODE button  23 until the appliance returns to custom mode.
Parts of the appliance are discolored.	Certain food or spices (e.g., curry) may discolor plastic. This is not a defect with the appliance.	Wash thoroughly although discoloring in plastic might be unavoidable.
A speed setting exceeding 3 cannot be selected.	A temperature has been set.	Set temperature to 0.
The appliance stops after 15 minutes.	A speed setting 7 - 10 was selected. At these speed settings, the appliance will function for a maximum of 15 minutes without a pause.	Select speed setting 0 - 6 (see "Setting the speed" on page 20).
When switching on, the set time is automatically set to 15:00.		

Problem	Cause	Solution
The mixing bowl lid 34 / the deep steaming tray 3 cannot be opened.	The electronic lock is activated (see "Electronic lock" on page 18).	Stop the appliance, let it cool and try removing the mixing bowl lid 34 / the deep steaming tray 3 .
	Did you try to open the mixing bowl lid 34 or the deep steaming tray 3 while appliance was cooling down? Possibly, the electronic lock is blocked.	Turn the mixing bowl lid 34 / the deep steaming tray 3 with both hands clockwise until it is completely closed (see "Put the lid on the mixing bowl" on page 25) or (see "Preparation of the steamer" on page 28).

14.2 Error messages on the screen

Display	Cause	Remedy
E3	The appliance is overloaded. Odor or smoke may develop.	<ul style="list-style-type: none"> The appliance can be used to process up to max. 16.7 oz / 500 g of flour. Let the appliance cool down completely for at least 10 minutes before next use. Afterwards, it is ready for use again.
	The mixing bowl lid 34 or deep steaming tray 3 have not been placed correctly onto the mixing bowl 5 .	Close the mixing bowl lid 34 correctly (see "Put the lid on the mixing bowl" on page 25). Or close steaming tray 3 correctly (see "Preparation of the steamer" on page 28).
	The turbo function cannot be used as the food temperature inside the mixing bowl 5 exceeds 140°F / 60 °C.	Set the speed using the SPEED button  19 and the SETTING dial 20 (see "Setting the speed" on page 20).
HHH	Temperature in the mixing bowl 5 is too high. There is not enough food or liquid in the mixing bowl 5 .	Switch the appliance off and let the mixing bowl cool down. Then add a sufficient amount of food or liquid into the mixing bowl 5 .
----	The scale 17 is overloaded.	Remove some weight from the scale. The maximum weight is 176.5 oz / 5000 g.

15. Disposal



This product is subject to the provisions of European Directive 2012/19/EC. The symbol showing a wheeled bin crossed through indicates that the product requires separate refuse collection in the European Union. This applies to the product and all accessories marked with this symbol. Products identified with this symbol may not be discarded with normal household waste, but must be taken to a collection point for recycling electric and electronic appliances.



This recycling symbol marks e.g. an object or parts of the material as valuable for recycling. Recycling helps to reduce the consumption of raw materials and protect the environment.

Packaging

When disposing of the packaging, make sure you comply with the environmental regulations applicable in your country.

16. Technical specifications

Model:	GM-CM-128W / SPM-128CSL
Mains voltage:	220V-240V or 120V
Protection class:	Class 1
Power rating:	1200W
Maximum filling volume of the mixing bowl 5 :	2.2L or 2.3QT
Maximum weighing capacity of the scale 17 :	5000 g or 176.5 oz

Customer Support:

Email: info@mygourmate.com

Phone: 1-888-783-6082

Website: www.mygourmate.com

Follow us:



Gourmate

1 YEAR LIMITED WARRANTY

IMPORTANT: Proof of Purchase is required to obtain warranty service.

Paragon Group USA Inc. warrants to the original owner that our products will be free from defect in workmanship and material for a period of ONE YEAR from the date of purchase. Should any unit(s) prove to be defective during this period, Paragon Group USA Inc. will be responsible for replacement of the defective unit(s) only. Paragon Group USA Inc. is not responsible for labor charges or any incidental or consequential expenses.

Not Covered – Batteries are not covered by this warranty. Repair service, adjustment and calibration due to misuse, abuse or negligence are not covered by this warranty. Unauthorized service or modification to this product or of any furnished components will void this warranty in its entirety. This warranty does not include reimbursement for inconvenience, installation, set-up time, loss of use, postage, unauthorized service, or other products used in conjunction with Gourmate products.

For warranty service, please contact Paragon Group USA Inc.

Customer Service by Phone: 1-888-783-6082 or e-mail: info@mygourmate.com

This warranty gives you specific legal rights, and you may also have other rights which vary from state to state.

Paragon Group USA Inc.
Gourmate Product Division
Englewood, NJ 07631
USA