

# VEROBOARD®

**LED Type:** VBDFS-4020-RGB-90-5-NS (Side Emitting)  
**Colour:** RGB (SK6812)



## DESCRIPTION

Flexible 8mm wide linear side-emitting digital LED strip. Available in 5 meters (16.4 feet) roll that can be cut after every LED (11.45 mm or 0.45 in). The LED strip lights are manufactured with high-quality materials and designed for professional lighting. Each LED is addressable and has an integrated IC driver V6842, allowing you total control over the color of each RGB SMD. Moreover, each SMD has a built-in SK6812 Smart Control Circuit. It helps in making the RGB chip in outer SMD into a fully controlled pixel. The strip light is an intelligent control LED light source integrated into the 4020 side-LED components. They are 90 RGB side-LEDs in a meter and need a 5V DC power supply.

## DIMENSIONS

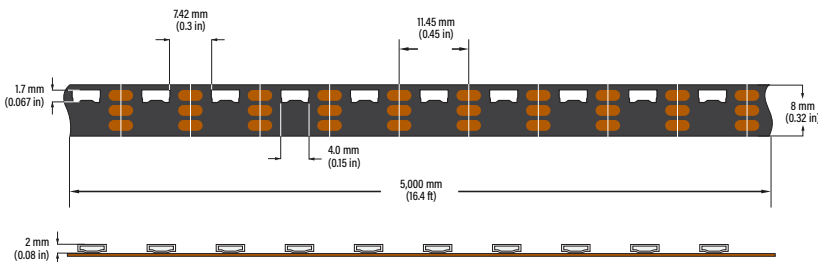

## SPECIFICATIONS

<b>Model:</b>	VBDFS-4020-RGB-90-5-NS (Side Emitting)
<b>Color Temperature:</b>	RGB (SK6812)
<b>LED Type:</b>	4020 SMD
<b>LED Qty:</b>	90 LEDs per meter
<b>Input Voltage (VF):</b>	5V DC
<b>Power:</b>	9W per meter (3W/ft)
<b>IC Driver:</b>	V6842 (Built-in)
<b>Lifespan:</b>	>50,000 hours
<b>PCB:</b>	4oz PCB, Double-side, white colour 8mm width
<b>IP Rating:</b>	IP20 (Indoor use only)
<b>Rendering Index (Ra):</b>	CRI>95
<b>Beam Angle:</b>	120°
<b>Dimmable:</b>	Yes
<b>Cut Size:</b>	11.45 mm (0.45 inches)
<b>Operating Temperature:</b>	-40°C to +60°C
<b>Dimensions:</b>	5,000mm x 8mm (196.8in x 0.31in)
<b>Certificates:</b>	UL / RoHS
<b>Roll Length:</b>	5 meter roll (16.4 feet)

Contact Name: \_\_\_\_\_

Company: \_\_\_\_\_

Phone: \_\_\_\_\_

Email: \_\_\_\_\_

	Wattage
Per Foot	3W/ft
Per Meter	9W/m



666561425418



0.45 in  
Cut Points

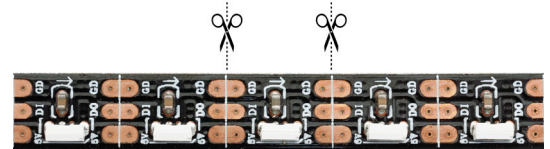

### ORDERING GUIDE

Example part number: **VBDFS - 4020 - RGB - 90 - 5 - NS**

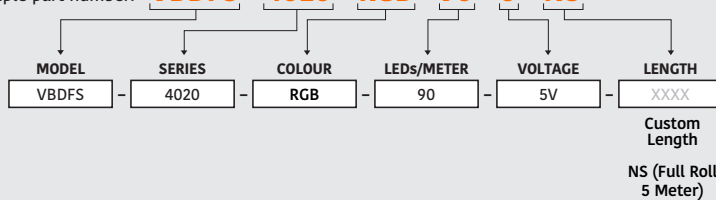

For more information about our products and services, please visit our website: [www.veroboard.com](http://www.veroboard.com)



### CUSTOM ORDERING GUIDE

**Single Run (Straight Run):** The below ordering guide will be used for single run LED strip.

- **PFL:** Power Feed Length
- **SL:** Strip Length

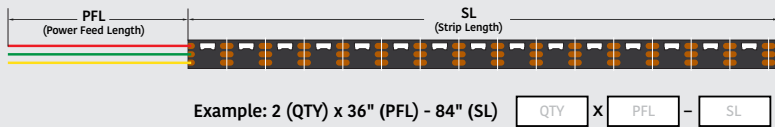

### CUSTOM ORDERING GUIDE

**Joiner:** LED strip lights need joiners if they are used for curve applications such as corner side, behind a mirror, etc.

- **PFL:** Power Feed Length
- **SL:** Strip Length
- **JL:** Joiner Length

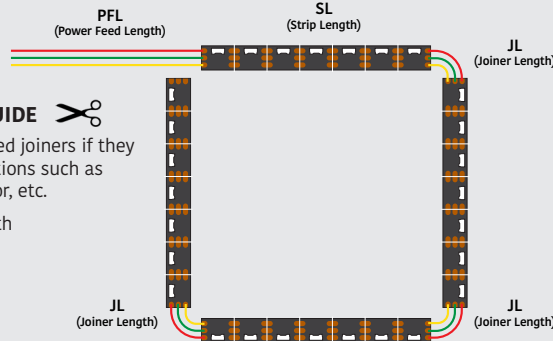

x  -  -  -  -  -  -  -

Example: 1 (QTY) x 12" (PFL) - 46" (SL) - 1" (JL) - 36" (SL) - 1" (JL) - 46" (SL) - 1" (JL) - 36" (SL)

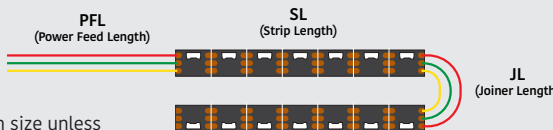

**Note:** Joiners will be 1-inch size unless customers require a specific size.

x  -  -  -

Example: 2 (QTY) x 24" (PFL) - 52" (SL) - 1" (JL) - 52" (SL)

## RECOMMENDED LED ALUMINUM CHANNELS

(Sold Separately)

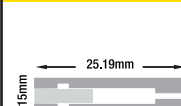
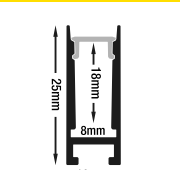
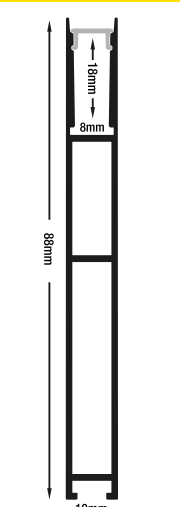
VBD-CH-RF9	VBD-CH-H1	VBD-CH-H2
		
SKU: 666561423421	SKU: 666561428570	SKU: 666561428594

## RECOMMENDED LED POWER SUPPLIES

(Sold Separately)

For more options and varieties, please visit our website:  
[www.veroboard.com](http://www.veroboard.com)

### Constant Voltage Dimmable LED Drivers (5 in 1), Triac/Phase, 0-10V, 1-10V, Potentiometer, 10V PWM 5 in 1 Dimming



Model No.	Input Voltage	Output Voltage	Wattage	IP Rating	Class	Max. Strip Length	SKU#
VBD-024-030C2DM5i1	100-277V	24V	30W	IP67	Class 2	8ft	666561426033
VBD-024-060C2DM5i1	100-277V	24V	60W	IP67	Class 2	16ft	666561426040
VBD-024-080C2DM5i1	100-277V	24V	80W	IP67	Class 2	21.4ft	666561426088
VBD-024-096C2DM5i1	100-277V	24V	96W	IP67	Class 2	25.6ft	666561426057
VBD-024-192C2DM5i1	100-277V	24V	192W	IP67	Class 1	51.2ft	666561426064
VBD-024-288C2DM5i1	100-277V	24V	288W	IP67	Class 1	76.8ft	666561426071

### Constant Voltage Triac LED Drivers forward Phase, Magnetic Low Voltage & Triac Dimmers



Model No.	Input Voltage	Output Voltage	Wattage	IP Rating	Class	Max. Strip Length	SKU#
VBD-024-024DM	100-130V	24V	24W	IP20	Class 2	6.4ft	666561415839
VBD-024-048DM	100-130V	24V	48W	IP20	Class 2	12.8ft	666561415822
VBD-024-060DM	100-130V	24V	60W	IP20	Class 2	16ft	666561415815
VBD-024-096DM	100-130V	24V	96W	IP67	Class 2	25.6ft	666561415808
VBD-024-150DM	100-130V	24V	150W	IP67	Class 1	40ft	666561415792
VBD-024-200DM	100-130V	24V	200W	IP67	Class 1	53.3ft	666561415785
VBD-024-300VTHWJ	100-277V	24V	300W	IP65	Class 1	80ft	666561419806

For more information about our products and services, please visit our website: [www.veroboard.com](http://www.veroboard.com)