

VEROBOARD®

Model: VBD-N1018-SD-W

Material:	Silicone
Colour:	White
Beam Angel:	120°
Channel Length:	5m (16.4ft) Max
Channel Width:	10mm (0.39")
Channel Height:	18mm (0.7")

Job Name: _____

Distributor: _____

Type: _____

VBD-N1018-SD-W (5 meters)

SKU: 666561433031

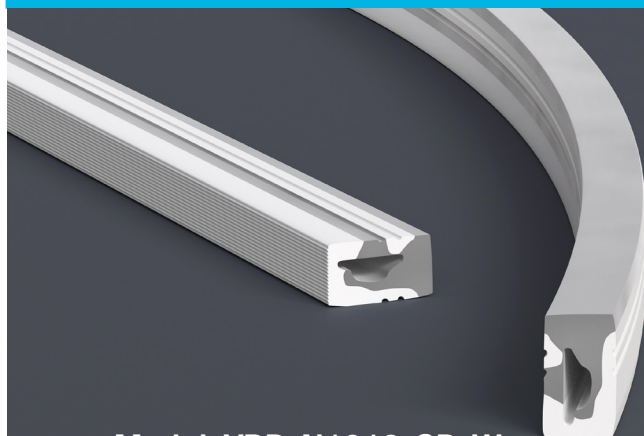

Model: VBD-N1018-SD-W

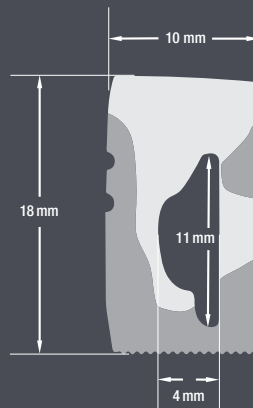

VBD-N1018-SD-W is designed to meet your needs with exceptional performance and quality. Please note that while this product is built to excel in various conditions, it is not recommended for extended exposure to strong UV rays or direct sunlight. If you intend to utilize the **VBD-N1018-SD-W** outdoors, we strongly recommend providing ample shade or protective cover to shield it from direct sunlight.

ACCESSORIES (Sold Separately)

End Caps (1 Pair/bag)	Mounting Clips (10 PCs/bag)	Flexible Clips (1 Meter)	Linear Mounting (1 Meter)
<p>Model: VBD-EN1018-W SKU: 666561433048</p>	<p>Model: VBD-CLN1018-MC SKU: 666561433079</p>	<p>Model: VBD-CLN1018-FC SKU: 666561433055</p>	<p>Model: VBD-CLN1018-LI SKU: 666561433062</p>

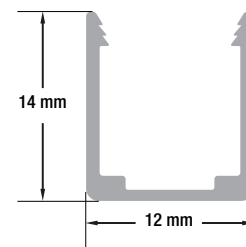
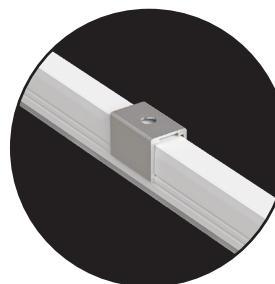

VEROBOARD®

LED Type: VBDFS-A5050-RGB60K-84-24-NS
Colour: RGB+6000K

	Wattage
Per Foot	4.5W/ft
Per Meter	15W/m



Job Name: _____

Distributor: _____

Type: _____



666561433253

DESCRIPTION

Flexible 10mm-wide linear LED strip, specially designed for our Flexible Neon Channels, does not include double-sided 3m tape so that it can be easily inserted into the neon channel. can be cut every 6 LEDs (71mm or 2.8 inches). These LED strip lights are crafted from premium materials and engineered for professional lighting applications. Each strip light starts with a robust dual-core copper printed circuit board (PCB), which is then fitted with an array of chips and color options through soldering.

DIMENSIONS

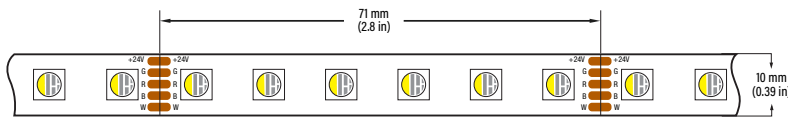

Back Side



SPECIFICATIONS

Model:	VBDFS-A5050-RGB60K-84-24-NS
Color Temperature:	RGB+6000K (Cool White)
LED Type:	5050 SMD
LED Qty:	84 LEDs per meter
Input Voltage (VF):	24V DC
Power:	15W per meter (4.5W/ft)
Lifespan:	>50,000 hours
PCB:	4oz PCB, Double-side, white colour 10mm width
Rendering Index (Ra):	CRI>95
Beam Angle:	120°
Dimmable:	Yes
Cut Size:	Every 6 LED chips (2.8")
Operating Temperature:	-15°C to +40°C
Dimensions:	10mm (0.39")
Certificates:	UL / RoHs

COMPATIBLE SILICONE NEON CHANNELS
(Sold Separately)



Model: VBD-N1616-SF-B
SKU: 666561432485



Model: VBD-N1616-SD-W
SKU: 666561432553



Model: VBD-N1018-SF-B
SKU: 666561433031



Model: VBD-N2020-SF-B
SKU: 666561432782



Model: VBD-N2020-SD-W
SKU: 666561432836



Model: VBD-N2020-SFD-W
SKU: 666561432881

For more information about our products and services, please visit our website: www.veroboard.com

VEROBOARD®

LED Type: VBDFS-E2835-XXXX-168-24-NS-10
Colour: 2700K • 3000K • 3500K • 4000K • 5000K

	Wattage	Brightness
Per Foot	4.2W/ft	500Lm/ft
Per Meter	14W/m	1640Lm/m



DESCRIPTION

Flexible 10mm-wide linear LED strip, specially designed for our Flexible Neon Channels, does not include double-sided 3m tape so that it can be easily inserted into the neon channel. can be cut every 7 LEDs (42mm or 1.63 inches). These LED strip lights are crafted from premium materials and engineered for professional lighting applications. Each strip light starts with a robust dual-core copper printed circuit board (PCB), which is then fitted with an array of chips and color options through soldering.

DIMENSIONS

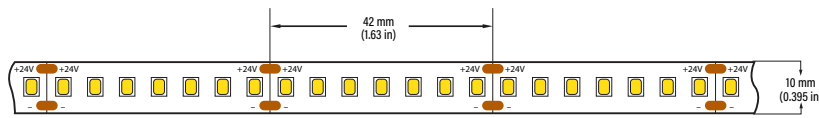

SPECIFICATIONS

Model:	VBDFS-E2835-xxxx-168-24-NS-10
Color Temperature:	2700K • 3000K • 3500K • 4000K • 5000K
LED Type:	2835 SMD
LED Qty:	168 LEDs per meter
Input Voltage (VF):	24V DC
Power:	14W per meter (4.2W/ft)
Brightness:	1640 Lm/meter (500 Lm/ft)
Lifespan:	>50,000 hours
PCB:	4oz PCB, Double-side, white colour 10mm width
Rendering Index (Ra):	CRI>95
Beam Angle:	120°
Dimmable:	Yes
Cut Size:	Every 7 LED chips (1.63")
Operating Temperature:	-15°C to +40°C
Dimensions:	10mm (0.39")
Certificates:	UL / RoHs

Job Name: _____

Distributor: _____

Type: _____



666561433192



666561433208



666561433215



666561433222



666561433239

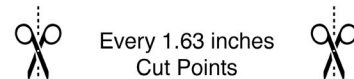

Every 1.63 inches
Cut Points



Back Side



**COMPATIBLE
SILICONE NEON
CHANNELS**
(Sold Separately)



Model: VBD-N1616-SF-B
SKU: 666561432485



Model: VBD-N1616-SD-W
SKU: 666561432553



Model: VBD-N1018-SF-B
SKU: 666561433031



Model: VBD-N2020-SF-B
SKU: 666561432782



Model: VBD-N2020-SD-W
SKU: 666561432836



Model: VBD-N2020-SFD-W
SKU: 666561432881

For more information about our products and services, please visit our website: www.veroboard.com