

VEROBOARD®

Model: VBD-N1010-SF-B

Material:	Silicone
Colour:	Black
Beam Angel:	120°
Channel Length:	5m (16.4ft) Max
Channel Width:	10mm (0.39")
Channel Height:	10mm (0.39")

Job Name: _____

Distributor: _____

Type: _____

VBD-N1010-SF-B (5 meters)

SKU: 666561432621



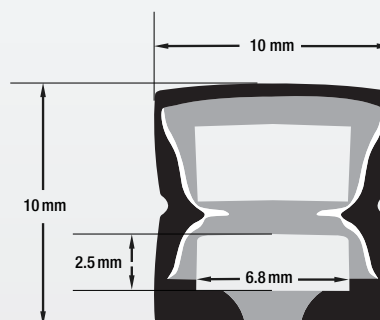

Model: VBD-N1010-SF-B

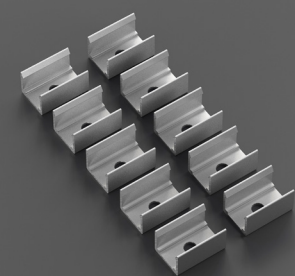
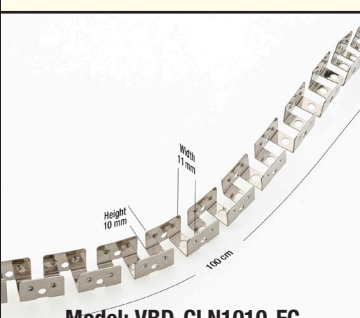

VBD-N1010-SF-B is designed to meet your needs with exceptional performance and quality. Please note that while this product is built to excel in various conditions, it is not recommended for extended exposure to strong UV rays or direct sunlight. If you intend to utilize the **VBD-N1010-SF-B** outdoors, we strongly recommend providing ample shade or protective cover to shield it from direct sunlight.

ACCESSORIES (Sold Separately)

End Caps (1 Pair/bag)	Mounting Clips (10 PCs/bag)	Flexible Clips (1 Meter)	Linear Mounting (1 Meter)
 <p>Model: VBD-EN1010-B SKU: 666561432638</p>	 <p>Model: VBD-CLN1010-MC SKU: 666561432669</p>	 <p>Model: VBD-CLN1010-FC SKU: 666561432645</p>	 <p>Model: VBD-CLN1010-LI SKU: 666561432652</p>

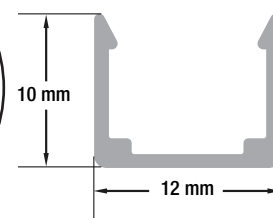
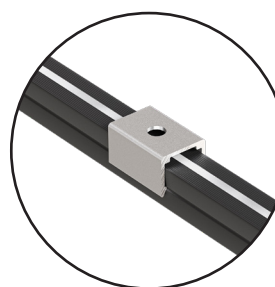

VEROBOARD®

LED Type: VBDFS-E2835-XXXX-168-24-NS-6
Colour: 2700K • 3000K • 3500K • 4000K • 5000K
 RED • GREEN • BLUE • YELLOW

	Wattage	Brightness
Per Foot	3.5W/ft	450Lm/ft
Per Meter	12W/m	1475Lm/m



DESCRIPTION

Flexible 6mm-wide linear LED strip, specially designed for our Flexible Neon Channels, does not include double-sided 3m tape so that it can be easily inserted into the neon channel. can be cut every 7 LEDs (42mm or 1.63 inches). These LED strip lights are crafted from premium materials and engineered for professional lighting applications. Each strip light starts with a robust dual-core copper printed circuit board (PCB), which is then fitted with an array of chips and color options through soldering.

DIMENSIONS

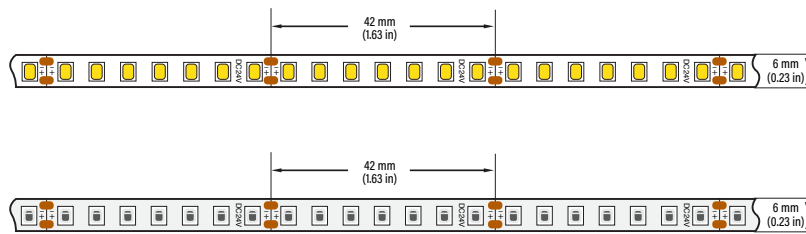

SPECIFICATIONS

Model:	VBDFS-E2835-xxxx-168-24-NS-6
Color Temperature:	2700K • 3000K • 3500K • 4000K • 5000K Red • Green • Blue • Yellow
LED Type:	2835 SMD
LED Qty:	168 LEDs per meter
Input Voltage (VF):	24V DC
Power:	12W per meter (3.5W/ft)
Brightness:	1475 Lm/meter (450 Lm/ft)
Lifespan:	>50,000 hours
PCB:	4oz PCB, Double-side, white colour 6mm width
Rendering Index (Ra):	CRI>95
Beam Angle:	120°
Dimmable:	Yes
Cut Size:	Every 7 LED chips (1.63")
Operating Temperature:	-15°C to +40°C
Dimensions:	6mm (0.23")
Certificates:	UL / RoHs

**COMPATIBLE
 SILICONE NEON
 CHANNELS**
 (Sold Separately)



Model: VBD-N1010-SF-B
 SKU: 666561432621



Model: VBD-N1010-SF-W
 SKU: 666561432676



Model: VBD-N0410-SD-W
 SKU: 666561432614

Job Name: _____

Distributor: _____

Type: _____



666561433093 666561433109 666561433116



666561433123 666561433130 666561433277



666561433284 666561433291 666561433307



Back Side



For more information about our products and services, please visit our website: www.veroboard.com