

SR-SPI-OLED (WiFi) with SR-2858ZA DMX LED Light Receiver, 5-24V DC

Model No.:	SR-SPI-OLED (WiFi)+SR-2858ZA
Input Voltage:	5V DC / 12-24V DC
Input Current:	0.2A Max.
Input Signal:	RF/WiFi + DMX512
Output Signal:	SPI
Radio Frequency:	869.5/916.5/434MHz
DMX Decoding Channels:	512 Channels
Driving Pixels:	Max. 1020
Package Content:	SR-SPI-OLED (WiFi) SR-2858ZA
Dimensions:	170mm x 54mm x 29mm (6.7" x 2.2" x 1.13")
Certifications:	CE/cRU/RoHS

Features:

- Integrate SR-SPI-OLED(WiFi) controller with SR-2858ZA LED Light Receiver for advanced LED control.
- Manage RGB/RGBW LED strip lights effortlessly with SPI technology and OLED panel.
- RF/WiFi and DMX512 input signals, with multiple RF frequency options.
- Drive up to 1020 pixels, compatible with 38 driving IC types.
- Configure pixel quantity, IC type, and 7 RGB/RGBW color order options.
- Access 35 dynamic color sequences through RF remotes or dedicated apps.
- Switch to DMX mode, support up to 512 decoding channels, easy DMX address configuration via OLED display.

SR-2858ZA W+ Remote Controller

Model No.:	SR-2858ZA
Output:	RF Signal
Voltage:	4.5V (3xAAA battery)
Frequency:	434MHz/869.5MHz/916.5MHz
Control Zone:	4 Zone
Compatible Controllers:	SR-SPI-OLED (WiFi)
Operating Temperature:	0-40° C
Relative Humidity:	8% to 80%
IP Rated:	IP20 (Indoor use only)
Dimensions:	152mm x 52mm x 20mm (6" x 2" x 0.7")
Certifications:	CE/FCC/RoHS

Job Name: _____

Distributor: _____

Type: _____

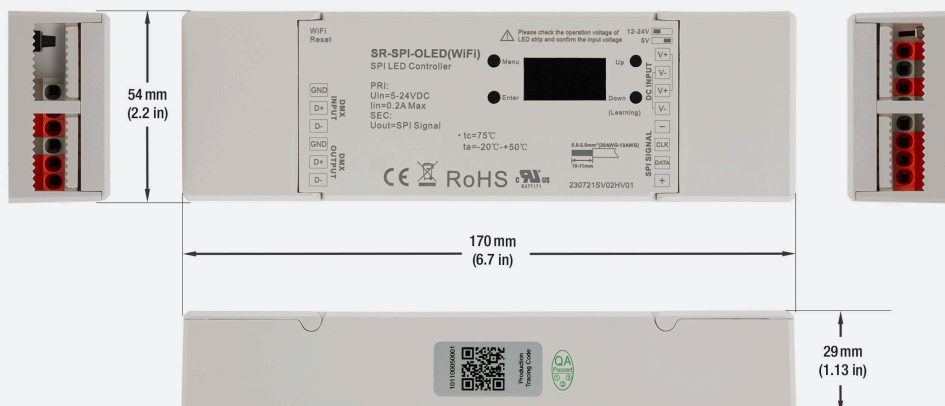

Disclaimer:

The data and information contained in this specification sheet are subject to change without notice; the ratings supplied are provided based on the product manufacturer. The information contained in this specification sheet should not be considered a warranty, expressed or implied, including, but not limited to, a warranty of merchantability or fitness for a particular purpose. In no event shall Veroboard be liable for any incidental or consequential damages resulting from the use, misuse, or inability to use the product. This exclusion applies regardless of whether such damages are sought based on breach of warranty, breach of contract, negligence, strict liability in tort, or any other legal theory.





Important: Read All Instructions Prior to Installation

Function introduction

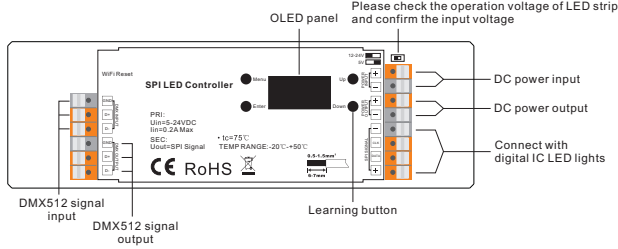

Product Data

Input Voltage	DC5V/DC12-24V
Input Current	0.2A Max.
Input Signal	RF/WIFI + DMX512
Output Signal	SPI
Radio frequency	869.5/916.5/434MHz
DMX Decoding Channels	512 Channels
Driving Pixels	Max. 1020
Product Dimension	170x53.4x28mm
Working Temperature	-20°C to 50°C
Waterproof Grade	IP20

- SPI signal output for control of RGB/RGBW pixel lights
- DMX512 controllable and RF/WIFI remote controllable
- Capable of addressing up to 1020 pixels
- The built-in, backlit OLED panel allows for easy configuration of most settings
- Four push buttons available for control of the OLED functions
- Supports 38 types of driving IC
- RGB/RGBW color order configurable
- 512 DMX decoding channels
- Support max. 3060 output channels configurable
- 35 built-in sequencing, chasing, changing and static colors under RF mode
- Compatible with a variety of RGB/RGBW RF remotes
- Works with PC interface DMX consoles and sequencing software

Safety & Warnings

- DO NOT install the device with power applied.
- DO NOT expose the device to moisture.

LED type (Setting RGB/RGBW color order)

There are 7 types of RGB/RGBW color order available: RGB, RBG, GRB, GBR, BRG, BGR, RGBW.

DMX address (Setting start and end address)

Under DMX mode, the DMX start address and end address can be set via buttons. The address can be set from 001-512.

For example, when the start address is set as 001, and end address as 003, then the controller will use 3 decoding channels. When the start address is set as 001, and end address as 004, then the controller will use 4 decoding channels.

When the start address is set as 001, and end address as 512, then the controller will use 512 decoding channels.

Output length (Setting output channel quantity)

Output length means total output channels or the number of pixels from the start pixel that you would like to address. Each RGB pixel has 3 channels output, and each RGBW pixel has 4 channels output. The controller support max. 3060 output channels.

For example, when the output length is set as 0003, the controller will be capable of addressing 1 RGB pixel, when the output length is set as 0004, the controller will be capable of addressing 1 RGBW pixel. When the output length is set as 3060, the controller will be capable of addressing 1020 RGB pixels or 765 RGBW pixels.

Wiring Diagram

1) Connection diagram under DMX system

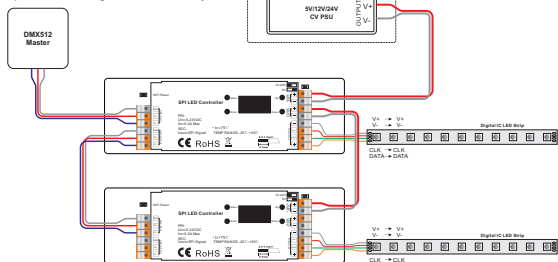

2) Connection diagram under RF system

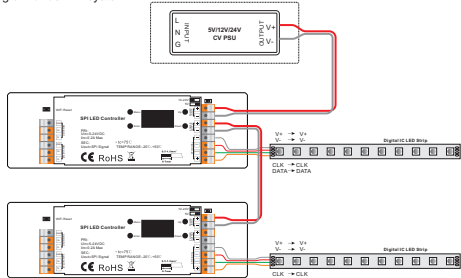

Function Introduction

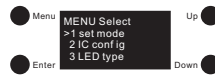

There are four buttons for configuration of settings with the OLED display: "Menu", "Enter", "Up" and "Down". Click "Menu" button to enter the menu selection interface, and keep clicking "Up" and "Down" buttons you will get 5 settings one by one as follows:



1. Set mode: to select an operation mode, click "Enter" button to enter the configuration interface, then click "Up" and "Down" buttons to choose RF or DMX mode, click "Menu" button to confirm the setting and return to menu selection interface.



2. IC config: to set driving IC type, click "Enter" button to enter the configuration interface, click "Up" and "Down" buttons to choose a IC type that drives your LED lights, click "Menu" button to confirm and return to menu selection interface. Total 34 kinds of driving IC available.

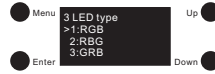

3. LED type: to set RGB/RGBW color order, click "Enter" button to enter the configuration interface, click "Up" and "Down" buttons to choose a color order, click "Menu" button to confirm and return to menu selection interface. Total 7 kinds of color order available.

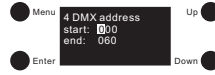

4. DMX address: to set DMX address under DMX mode, click "Enter" button to enter the configuration interface, the cursor will be on the "hundreds" position of the start address, click "Up" and "Down" buttons to change the number, click "Enter" button to confirm and move the cursor to "tens" position and set, then "units" position, and then the end address, and click "Menu" button to confirm the setting and return to menu selection interface.



5. Output length: to configure total output channels, click "Enter" button to enter the configuration interface, the asterisk is on the "thousands" position, click "Up" and "Down" buttons to change the number, click "Enter" button to confirm and move the asterisk to "hundreds" position and set, then "tens" position and "units" position, and click "Menu" button to confirm and return to menu selection interface. The SPI controller supports max. 3060 output channels.

Set mode

The controller has two working modes: RF and DMX. Follow the instructions to choose a mode you would like. Under RF mode, it converts RF signal to SPI signal, and shall be paired to a RF remote. Under DMX mode, it converts standard DMX signal to SPI signal, and can be controlled by universal DMX consoles.

IC config (Setting Pixel Protocol)

This SPI controller works with all common pixel protocols, make sure that the pixel protocol used by your lights is compatible with the controller. See the exact 38 protocol types supported as follows:

- WS2801 • LPD1101 • TM1804H • TM1829L • UCS1912 • UCS6912 • APA104
- WS2803 • LPD6803 • TM1809L • TM1829H • UCS2903 • P9813 • SK6812
- WS2811L • LPD8803 • TM1809H • UCS1903L • UCS2909L • D705
- WS2811H • LPD8806 • TM1812 • UCS1903H • UCS2909H • TLS3001
- WS2812 • TM1803 • TM1825L • UCS1909L • UCS2912 • TLS3002
- WS2813 • TM1804L • TM1825H • UCS1909H • UCS6909 • APA102

If you use multiple receivers, you have two choices:

Option 1: have all the receivers in the same zone, like zone 1



Option 2: have each receiver in a different zone, like zone 1, 2, 3 or 4

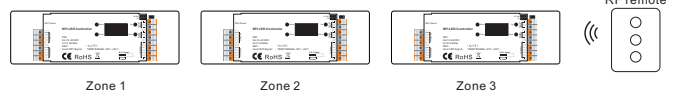

Operation

1. Power input

5VDC/12-24VDC voltage can be set by a DIP switch

Please set the correct voltage according to the type of LED pixel to be controlled before wiring

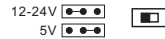

2. SPI signal output

+ is Positive voltage output (voltage depends on input)

CLK is the Clock signal (only used with four wire pixels)

Data is the Data signal (used on all pixels)

- is Negative voltage output (voltage depends on input)

RF Mode

After choosing RF mode and configuration of all settings, click "Menu" button to return to Menu select interface, click it again to show the detailed configuration information.



1. Pair to the RF remote

Turn on the RF remote -> Click "Down" button on the SPI controller -> Click any zone button on the remote to select a zone and immediately touch color wheel on the remote -> OLED display of the SPI controller will show "Learning OK" and connected LED lights blink to indicate successful pairing to the zone

2. Delete the pairing

Press and hold down "Down" button on the SPI controller until OLED display shows "Learning Delete" and connected LED lights blink, which means the pairing is deleted successfully

3. Built-in sequences under RF mode

There are 35 built-in sequencing, chasing, changing and static colors under RF mode, and you can play, pause, speed up or down them with a RF remote after successful pairing.

4. Control with a RF remote

Under RF mode, all configured pixels will be addressed by macro mode and can not be addressed individually.

DMX Mode

After choosing DMX mode and configuration of all settings, click "Menu" button to return to Menu select

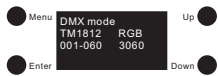

Under DMX mode, the controller is capable of addressing each pixel individually (3 DMX channels for each RGB pixel, 4 DMX channels for each RGBW pixel) or work with macro mode that allows you to address an entire string of RGB/RGBW pixels with just 3/4 DMX channels.

DMX source device (DMX console) and sequencing software (when not used in RF mode with built in sequences.) are required for control under DMX mode.

Set DMX Address & Output Length

Each RGB pixel requires 3 DMX decoding channels, and each RGBW pixel requires 4. Please set the DMX address quantity as a multiple of 3 or 4.

For RGB pixels it's best to set the start address number as 001 or 001 plus a multiple of 3 (004, 007, 010...508) and set the end address as a multiple of 3 and greater than the start address (003, 006, 009...510).

For RGBW pixels it's best to set the start address number as 001 or 001 plus a multiple of 4 (005, 009, 013...509) and set the end address as a multiple of 4 and greater than the start address (004, 008, 012...512).

Each RGB pixel has 3 channels output, and each RGBW pixel has 4. Please set the output length (channels) as a multiple of the previously set DMX address quantity.

When addressing each pixel individually, the DMX channels for output channels of each pixel are as follows:

Addressing RGB Pixels

DMX Addresses	Pixel No.	Decoding Channel -> Output Channel
001-003	1st	1 -> R, 2 -> G, 3 -> B
004-006	2nd	4 -> R, 5 -> G, 6 -> B
007-009	3rd	7 -> R, 8 -> G, 9 -> B
010-012	4th	10 -> R, 11 -> G, 12 -> B
...
508-510	170*	508 -> R, 509 -> G, 510 -> B

Addressing RGBW Pixels

DMX Addresses	Pixel No.	Decoding Channel -> Output Channel
001-004	1st	1 -> R, 2 -> G, 3 -> B, 4 -> W
005-008	2nd	5 -> R, 6 -> G, 7 -> B, 8 -> W
009-012	3rd	9 -> R, 10 -> G, 11 -> B, 12 -> W
013-016	4th	13 -> R, 14 -> G, 15 -> B, 16 -> W
...
509-512	128*	509 -> R, 510 -> G, 511 -> B, 512 -> W

Product Data

Output	RF signal	
Operation Frequency	869.5/916.5/434MHz	• Control 4 zones of RF receiver • RGBW controller
Power Supply	4.5V(3xAAA battery)	• Compatible with universal serie RF receiver • 1 receiver can be paired by max 8 different remote controls. • Waterproof grade: IP20
Operating temperature	0-40°C	
Relative humidity	8% to 80%	
Dimensions	153x52x19mm	

Safety & Warnings

- This device contains AAA batteries that shall be stored and disposed properly.
- DO NOT expose the device to moisture.

Pair with RF receiver(Method 1)

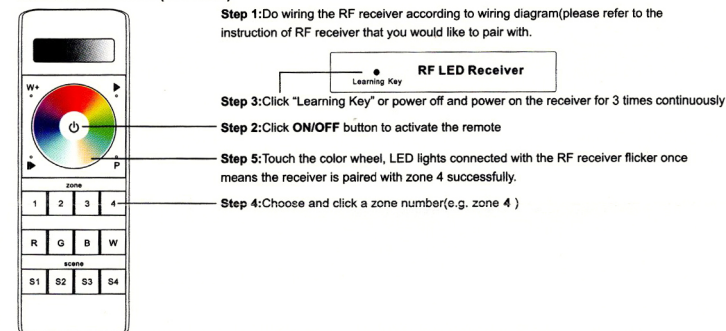

Pair with RF receiver(Method 2)

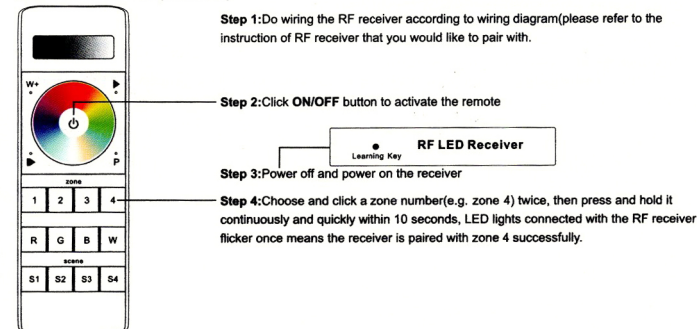

RF Wireless LED Dimmer



Important: Read All Instructions Prior to Installation

Function introduction

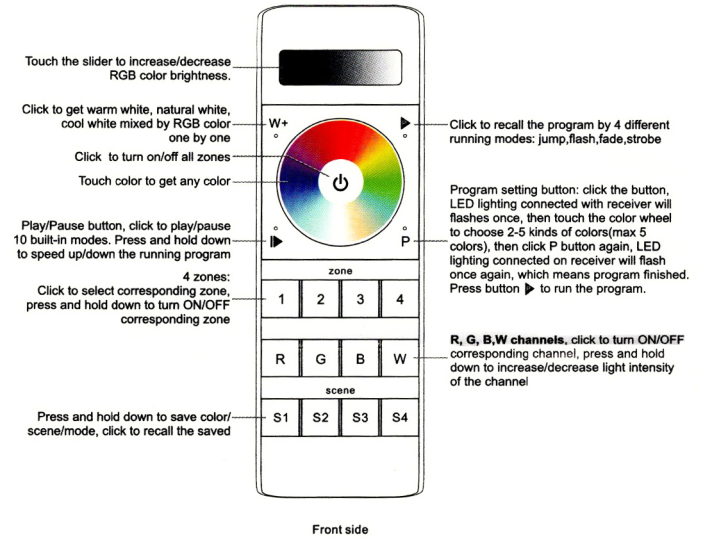

Front side

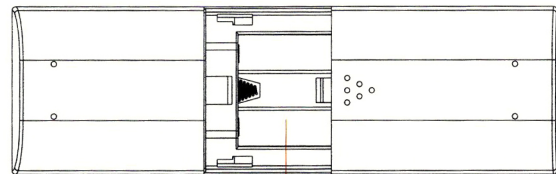

4.5V(3xAAA battery)

Back side

Program the running mode

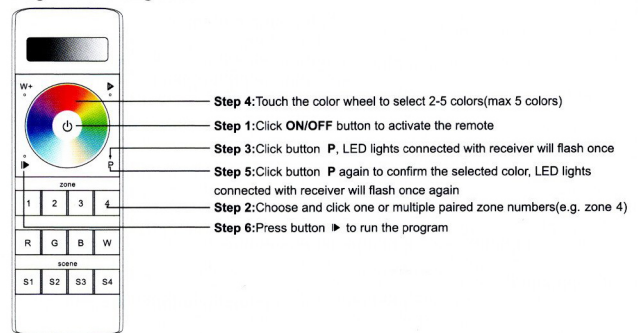

If you use multiple receivers, you have two choices:

Option 1: have all the receivers in the same zone, like zone 1



Option 2: have each receiver in a different zone, like zone 1, 2, 3 or 4



How to stop running mode of single color LED light caused by RGBW sender interference:

1. When pairing single color LED light to a single color remote, it might be interfered and paired by nearby RGBW senders, which might control the single color light into running mode. The running mode can not be stopped by the paired single color remote or by delete pairing.
2. Then we need this remote, and pair the remote to the receiver via above "Pair with RF receiver(Method 2)", then touch the color wheel to stop the running mode.
3. Then delete pairing and pair the receiver to the single color remote again, it can be controlled by the remote again.