

VEROBOARD®

4" 8W 5CCT Adjustable LED Light Gimbal



Veroboard 4 inches 1 head regressed downlight is specially designed to eliminate glare when illuminated. It is an IC-rated fixture that comes along with a junction box LED driver. It has the option of choosing desired color temperature from 2700K-3000K-3500K-4000K-5000K. This light is perfect for both new construction and remodeling installation with easy push spring clips.

SPECIFICATIONS

Model No:	EW34CG
Input:	100-130V AC
Power:	8W
Frequency:	50/60Hz
LED Type:	COB
Brightness:	800Lm
Color Temperature:	5CCT Selectable Color Temperature (2700K-3000K-3500K-4000K-5000K)
Beam Angle:	40°
Gimbal Tilt Angle:	40°
Dimmable:	Yes
IC Rated:	Type IC Rated
Location Approved:	Damp Location
Fixture Dimensions:	Ø120mm x Depth 55mm (4.75in x 2.16in)
Driver Dimensions:	110 x 55 x 35mm (4.3in x 2.375in x 1.375in)
Cut-out Hole Dimension:	Ø77mm x (Ø3in)
Certification:	cETLus/cUL

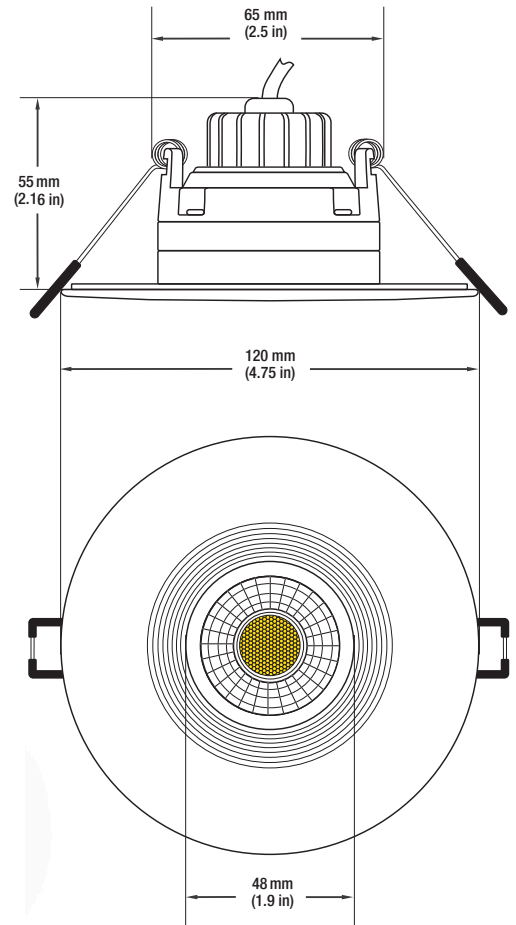
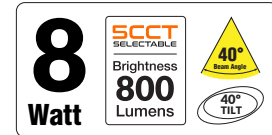

FEATURES

- Color adjustable by dip switch in the driver box.
- The fixture is attached with a baffle cap, making it easy to look at even at high ceilings.
- Universal gimbal with 40° tilting, airtight rated, connecting separated junction box, without housing can be used as for great cost saving.
- A solid die-casting heat sink gives light perfect heat dissipation to maintain a long life of up to 50,000 hrs.
- Nice looking smooth white face in oily spray prevents scratches when in use.
- Easy installation, fast connecting with the input wires, and prompt clip on the ceiling with spring helps on saving labor cost.

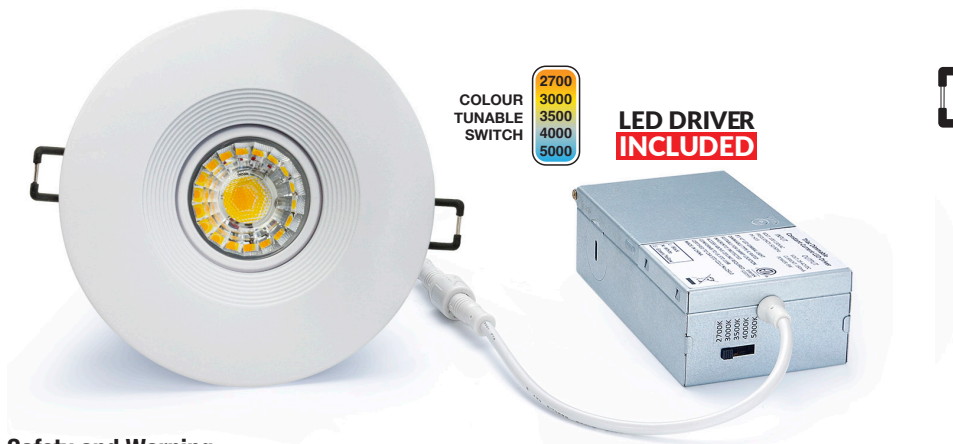

Safety and Warning

The fixture must be wired in accordance with local electrical codes. All the installation must be done by a certified electrician. Do not modify the product, any modification may render the product unsafe and void the warranty.



SKU: 666561429027

Light Measurement Report

Print date: 2023-01-09

Measurement date and time: 2023-01-09 10:17:19 AM – Measurement no. VFR-230109-0065-MS

Luminous Intensity diagram

Unit: 0-100% of peak intensity

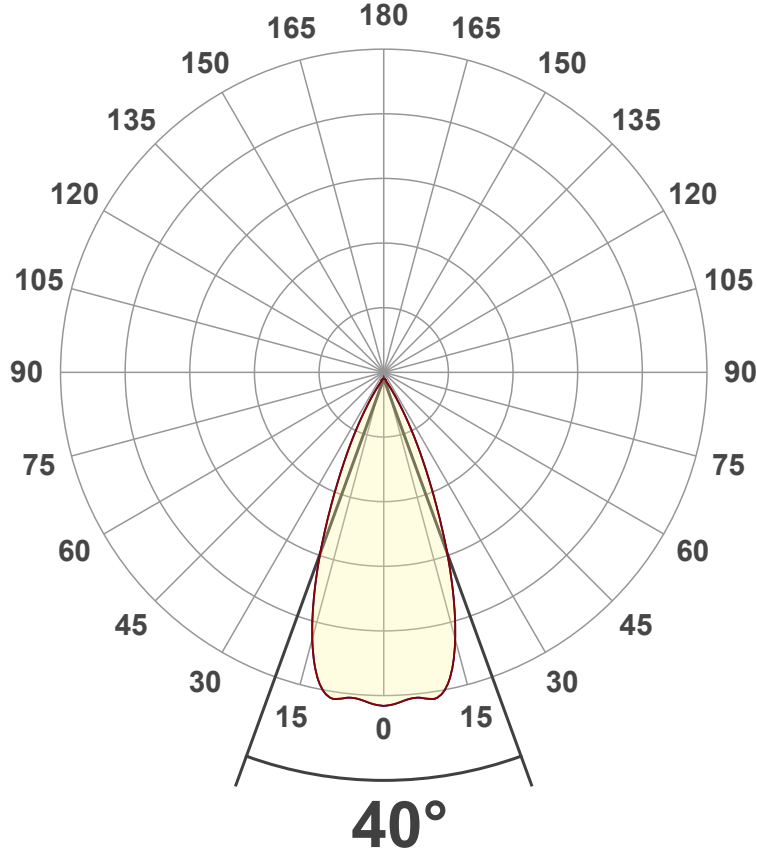

Main Values

Output (total Lumen)	800 lm
Lumen Up% / Down%	0% / 100%
Peak Intensity	1495 cd
Beam Angle (50%)	40°
Beam Angle (90%)	43°
Beam Angle (10%)	43°

Cut-off Angle

Average 2,5%	77.2°
--------------	-------

Field Angle

Average 10%	63.8°
-------------	-------

Intensity Ratio

In 120° cone	98.5%
In 90° cone	96.3%

C000-C180

C090-C270

Linear distribution diagram - Intensity (candela) vs γ -angle

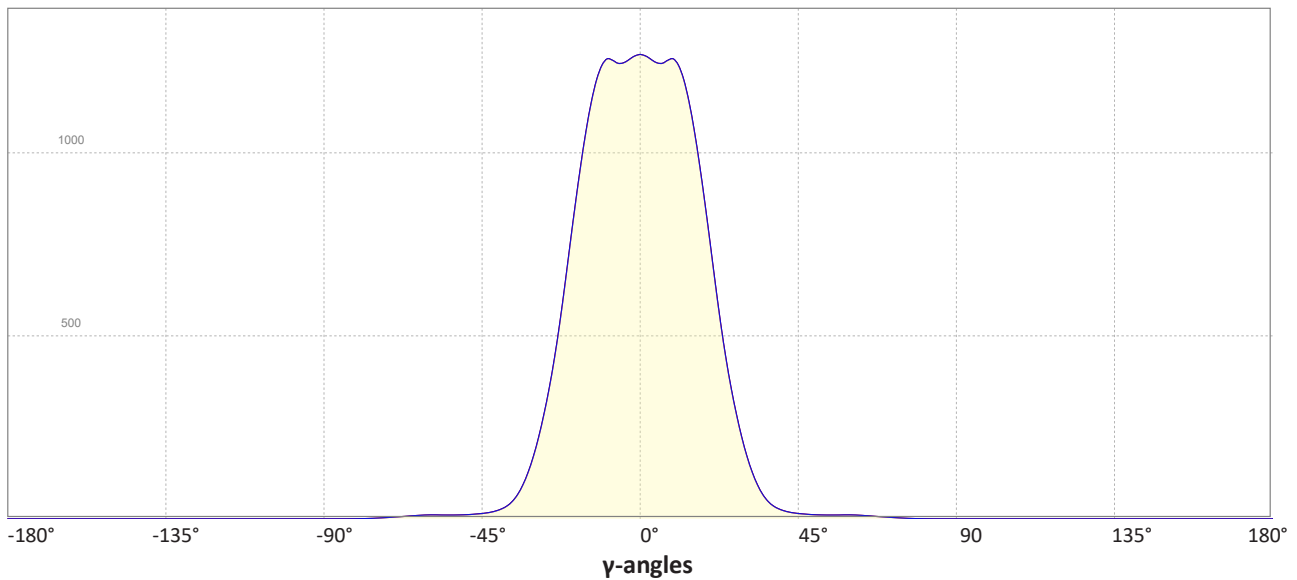

Light Measurement Report

Print date: 2023-01-09

Measurement date and time: 2023-01-09 10:17:19 AM – Measurement no. VFR-230109-0065-MS

Color details

Correlated Color Temperature, Target CCT = 3000 K
 Correlated Color Temperature, Measured CCT = 2912 K
 Color Rendering Index CRI 88.9
 Color Rendering Index, R9 (red component) R9 = 35.4
 Color Rendering TM30-18 R_f 87.4 – R_g 94.0
 Color Quality Scale CQS = 88.0

MacAdam Steps
 Color coordinates CIE 1931 (x;y) = (0.437;0.404)
 Color coordinate CIEs 1960 (u';v') = (0.251;0.348)
 Color deviation from BBL Duv = -0.0005
 Color coordinate CIEs 1976 (CIELUV) (u'';v'') = (0.251;0.251)

CIE 1931

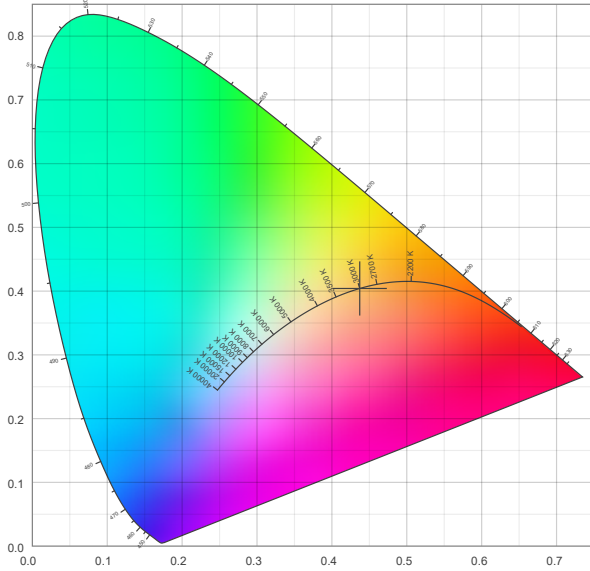

CIE 1931 – zoomed on Planckian locus

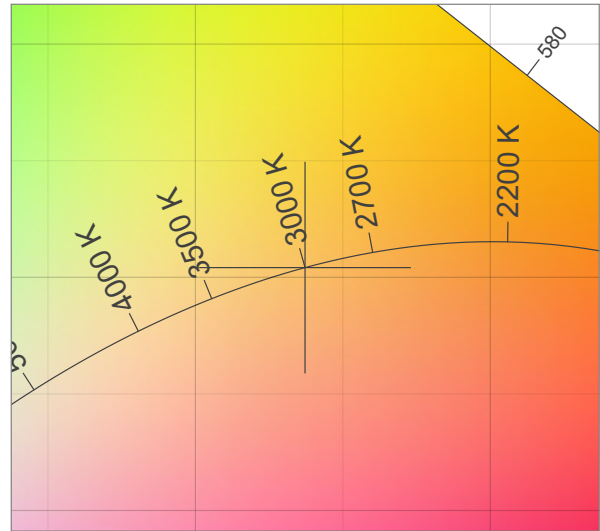

Color Rendering Index per reference color (CIE 1995)

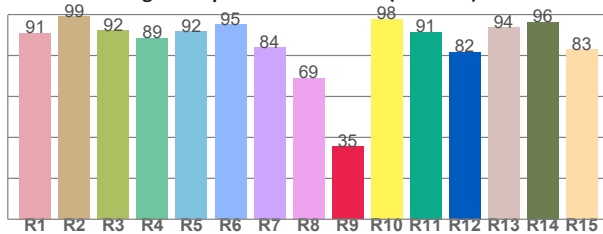

CRI R values, only R1-R8 are used to calculate final CRI value

R1	R2	R3	R4	R5	R6	R7	R8	R9	R10	R11	R12	R13	R14	R15
91.0	99.0	92.3	88.5	91.7	95.2	84.0	69.1	35.4	97.9	91.5	81.6	93.8	96.5	82.9

Spectral power distribution (SPD) / W/nm – 0-100%

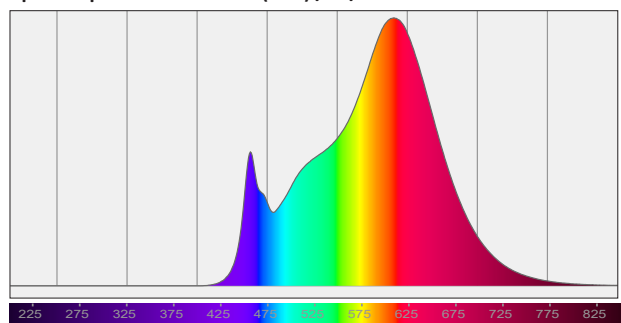

TM30-18 Rf-values per hue bin

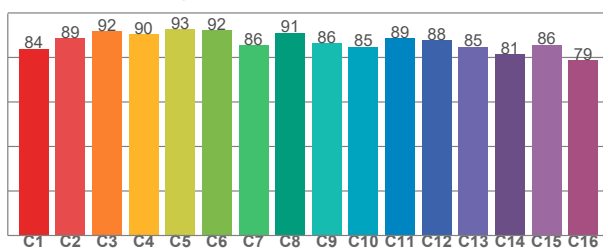

TM30 C values, 16 binned values out of total of 99 C values

C1	C2	C3	C4	C5	C6	C7	C8	C9	C10	C11	C12	C13	C14	C15	C16
83.8	88.6	91.8	90.5	92.6	92.2	85.6	91.2	86.3	84.9	88.6	87.8	84.9	81.4	85.7	78.7

Color Quality Scale by reference color

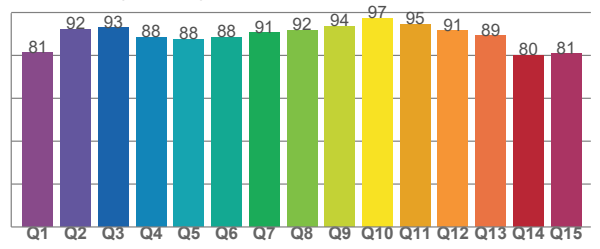

CQS Q values

Q1	Q2	Q3	Q4	Q5	Q6	Q7	Q8	Q9	Q10	Q11	Q12	Q13	Q14	Q15
81.2	92.2	93.0	88.4	87.7	88.5	90.5	91.6	93.5	97.2	94.6	91.5	89.2	80.2	80.8

Light Measurement Report

Print date: 2023-01-09

Measurement date and time: 2023-01-09 10:17:19 AM – Measurement no. VFR-230109-0065-MS

Beam Details

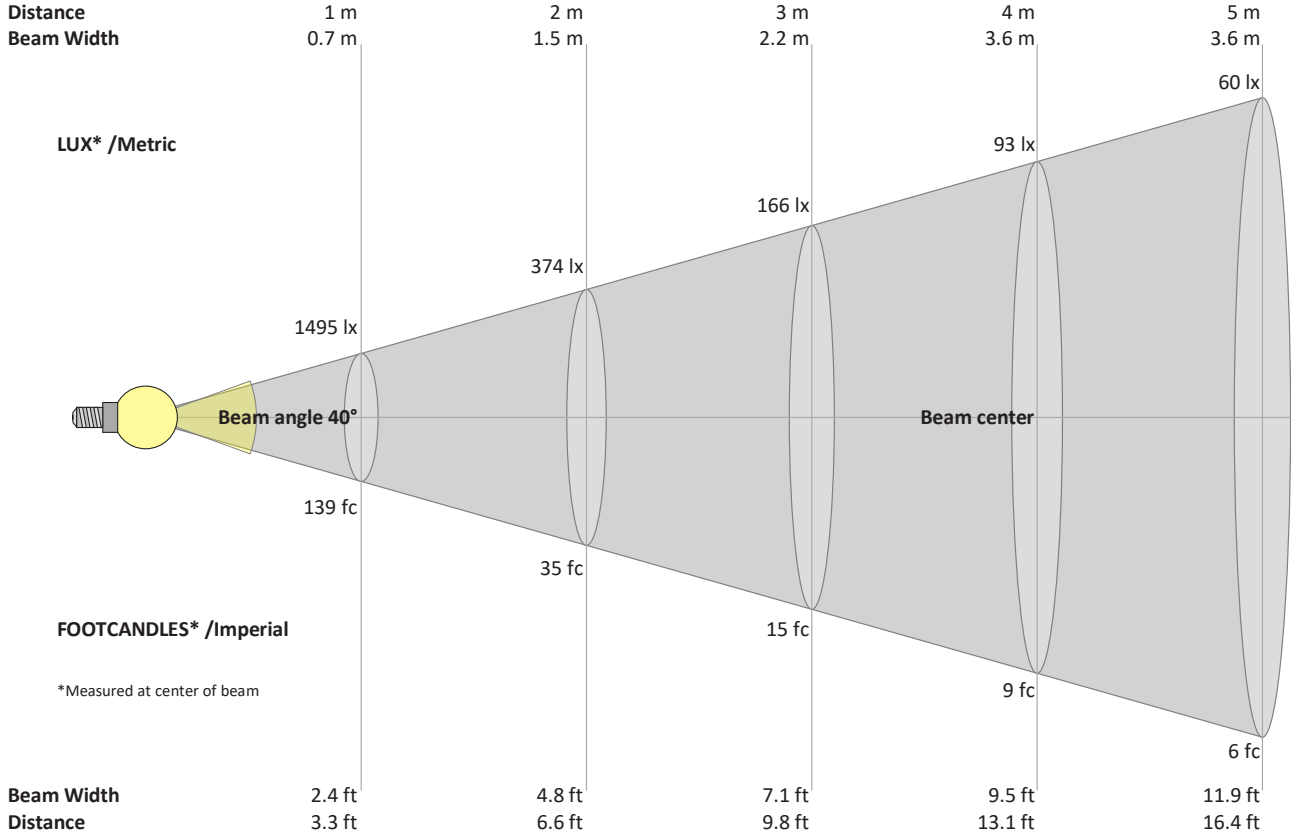

Beam intensities from 1 – 20 m

1	2	3	4	5	6	7	8	9	10	11	12	13	14	15	16	17	18	19	20	m
3.3	6.6	9.8	13.1	16.4	19.7	23	26.2	29.5	32.8	36.1	39.4	42.7	45.9	49.2	52.5	55.8	59.1	62.3	65.6	ft
1495	374	166	93	60	42	31	23	18	15	12	10	9	8	7	6	5	5	4	4	lux
138.9	34.7	15.4	8.7	5.6	3.9	2.8	2.2	1.7	1.4	1.1	1	0.8	0.7	0.6	0.5	0.5	0.4	0.4	0.3	fc

Intensities in 0° c-plane

0°	2°	4°	6°	8°	10°	12°	14°	16°	18°	20°	22°	24°	26°	28°	30°	32°	34°	36°	38°	y
1495	1488	1473	1467	1477	1473	1426	1336	1206	1050	879	705	547	415	307	217	147	97	62	41	cd
100%	100%	99%	98%	99%	99%	95%	89%	81%	70%	59%	47%	37%	28%	21%	15%	10%	6%	4%	3%	of 0°val

Intensities in 90° c-plane

0°	2°	4°	6°	8°	10°	12°	14°	16°	18°	20°	22°	24°	26°	28°	30°	32°	34°	36°	38°	y
1495	1488	1473	1467	1477	1473	1426	1336	1206	1050	879	705	547	415	307	217	147	97	62	41	cd
100%	100%	99%	98%	99%	99%	95%	89%	81%	70%	59%	47%	37%	28%	21%	15%	10%	6%	4%	3%	of 0°val

Intensities in 180° c-plane

0°	2°	4°	6°	8°	10°	12°	14°	16°	18°	20°	22°	24°	26°	28°	30°	32°	34°	36°	38°	y
1495	1488	1473	1467	1477	1473	1426	1336	1206	1050	879	705	547	415	307	217	147	97	62	41	cd
100%	100%	99%	98%	99%	99%	95%	89%	81%	70%	59%	47%	37%	28%	21%	15%	10%	6%	4%	3%	of 0°val

Intensities in 270° c-plane

0°	2°	4°	6°	8°	10°	12°	14°	16°	18°	20°	22°	24°	26°	28°	30°	32°	34°	36°	38°	y
1495	1488	1473	1467	1477	1473	1426	1336	1206	1050	879	705	547	415	307	217	147	97	62	41	cd
100%	100%	99%	98%	99%	99%	95%	89%	81%	70%	59%	47%	37%	28%	21%	15%	10%	6%	4%	3%	of 0°val