

## Model: VBD-012-150DD

<b>Input Voltage:</b>	100 – 265V AC
<b>Input Current:</b>	1.56A
<b>Frequency:</b>	50/60 Hz
<b>Output Voltage:</b>	12V DC
<b>Output Regulated Current:</b>	12.5A
<b>Max Power:</b>	150W max
<b>Power Factor:</b>	0.95
<b>IP Rating:</b>	IP65 (Dry, Damp, and Wet Locations)
<b>Dimmable:</b>	Yes
<b>Wiring/Housing:</b>	Hardwire
<b>Dimensions (Without Box):</b>	234 x 76 x 43mm (9.2 x 3 x 1.6")
<b>Dimensions (Box):</b>	394 x 84 x 60mm (15.5 x 3.3 x 2.5")
<b>Standards:</b>	FC/UL/RoHS

Job Name: \_\_\_\_\_

Distributor: \_\_\_\_\_

Type: \_\_\_\_\_



Veroboard Tech Inc. offers 12V, 24V DC DALI dimmable LED driver which is ETL/cETL FCC CE ROHS listed. Function conform to DALI protocol IEC62386. Dimming range from %0.1 to %100. Strong compatibility, flicker free dimming. Suitable for all LED lighting applications Compliance to worldwide safety regulations for lighting.



### Features

- 1 Output constant voltage
- 2 Built-in active PFC function
- 3 Efficiency >87% PF >0.9
- 4 Dimming range from 0.1% to 100%
- 5 Cooling by free air convection
- 6 Dimming Function: Built in DALI interface dimming function
- 7 Protections: Short circuit/overload/over current/over temperature
- 8 Conform to DALI Protocol IEC62386
- 9 Suitable for intelligent LED lighting
- 10 Compliance to worldwide safety regulations for lighting
- 11 Working Temperature: -40~+60°C

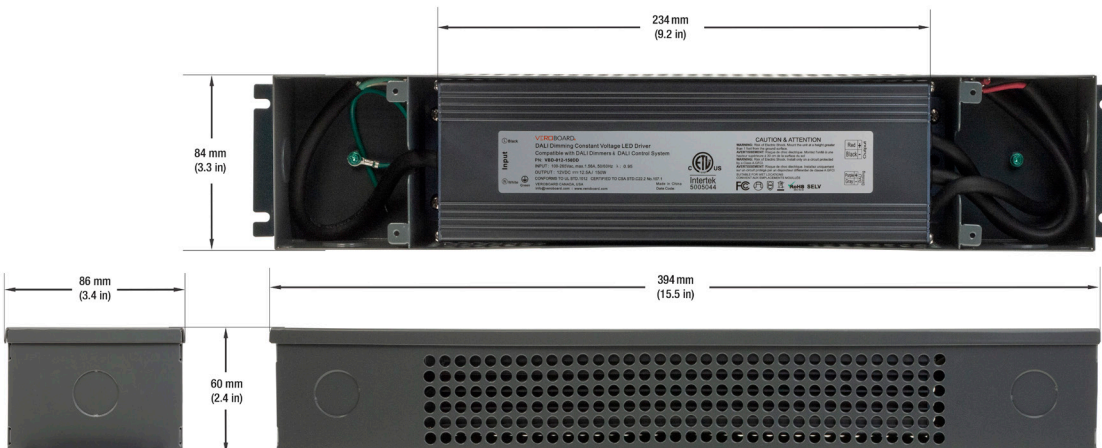

SKU: 666561427351

## Wiring Diagram

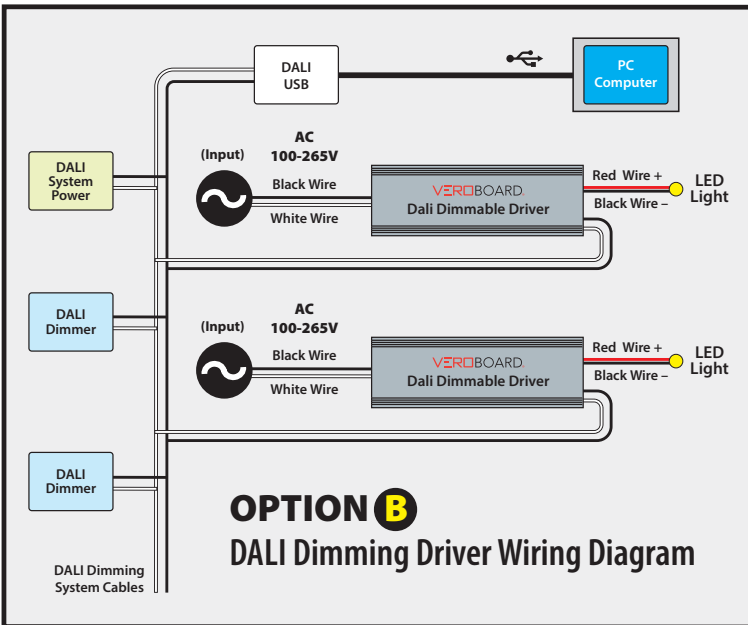
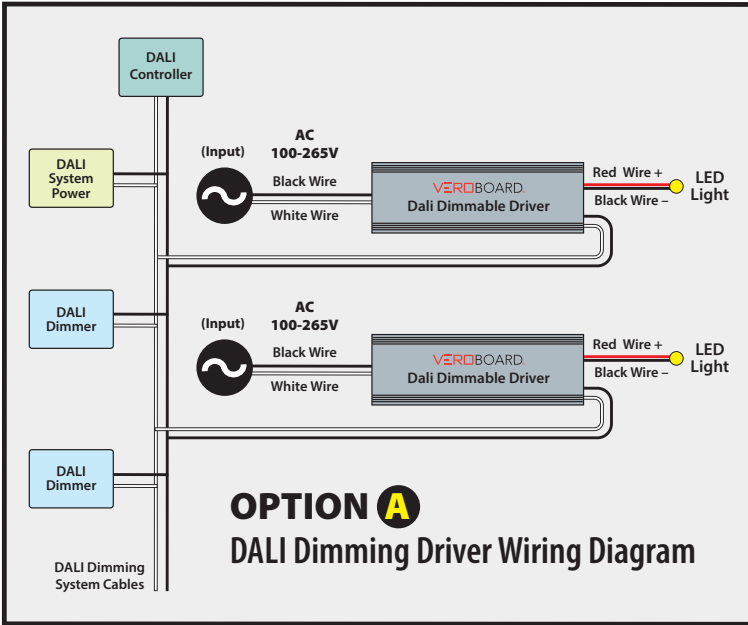

## Derating Curve

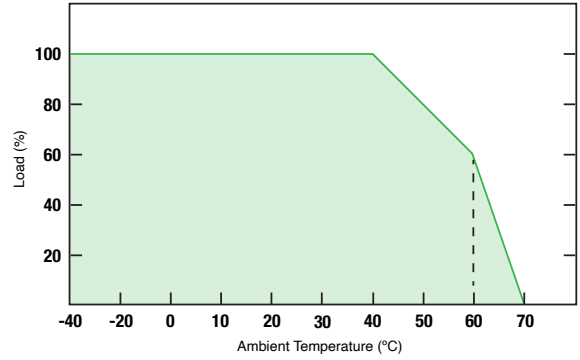

### Disclaimer:

The data and information contained in this specification sheet are subject to change without notice; the ratings supplied are provided based on the product manufacturer. The information contained in this specification sheet should not be considered a warranty, expressed or implied, including, but not limited to, a warranty of merchantability or fitness for a particular purpose. In no event shall Veroboard be liable for any incidental or consequential damages resulting from the use, misuse, or inability to use the product. This exclusion applies regardless of whether such damages are sought based on breach of warranty, breach of contract, negligence, strict liability in tort, or any other legal theory.