

VEROBOARD®

3.5"-1 Head Regressed Gimbal



Veroboard 3.5 inches 1 head regressed downlight is specially designed to eliminate glare when illuminated. It is an IC-rated fixture that comes along with a junction box LED driver. It has the option of choosing desired color temperature from 2700K-3000K-3500K-4000K-5000K. This light is perfect for both new construction and remodeling installation with easy push spring clips.

SPECIFICATIONS

Engine Model No:	AD-35S12W-5CCTWH-REY-SQ
Voltage:	120V AC
Frequency:	60Hz
Power Factor (PF):	0.9
Wattage:	12W
LED Driver:	IC Rated
Color Temperature:	5CCT Selectable Color Temperature (2700K-3000K-3500K-4000K-5000K)
Beam Angle:	40°
Gimbal Tilt Angle:	15°
Dimmable:	Yes
Dimming:	100 - 10% (Triac Dimming)
Dimmers:	LED/CEL Dimmers
Brightness:	800 Lumens
Rendering Index:	CRI>90
LED Type:	Integrated COB LED
Fixture Color:	White
Fixture Material:	Die-Cast Aluminum
Trim Shape:	Square
Rated Life:	50,000 Hours
Installation:	Recessed/Flush Mount
IP Rating:	IP20 (Damp Locations)
Outer Dimensions:	111.40 x 111.40 x 77.66 mm (4.4 x 4.4 x 3 in) Depth
LED Driver Dimensions:	85 x 85 x 32 mm (3.35 x 3.35 x 1.25 in)
Cut Size:	95 mm (3.75 in)
Package Content:	Light Fixture with IC-Rated LED Driver
Package Dimensions:	7.1 x 6 x 4.2 in (18 x 15.3 x 10.6 cm)
Package Weight:	0.692 Kg
Certification:	FCC/ETL/Energy Star/RoHS

Name: _____

Quantity: _____

Phone: _____

Email: _____

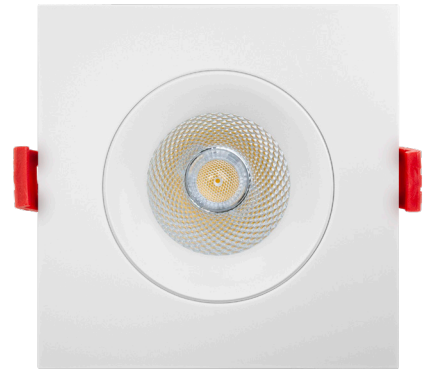

15° TILT

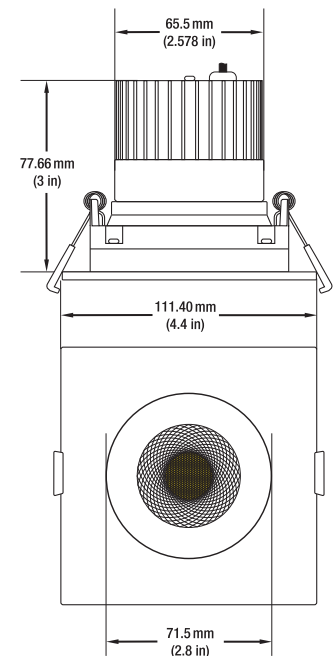

Selectable
Color Temperature
Switch

LED Driver Dimensions:
Length: 85 mm (3.35 in)
Width: 85 mm (3.35 in)
Depth: 32 mm (1.25 in)



Safety and Warning

The fixture must be wired in accordance with local electrical codes. All the installation must be done by a certified electrician. Do not modify the product, any modification may render the product unsafe and void the warranty.



SKU: 666561425166

Light Measurement Report

Print date: 2023-01-06

Measurement date and time: 2023-01-06 12:18:03 PM – Measurement no. VFR-230106-0052-MS

Luminous Intensity diagram

Unit: 0-100% of peak intensity

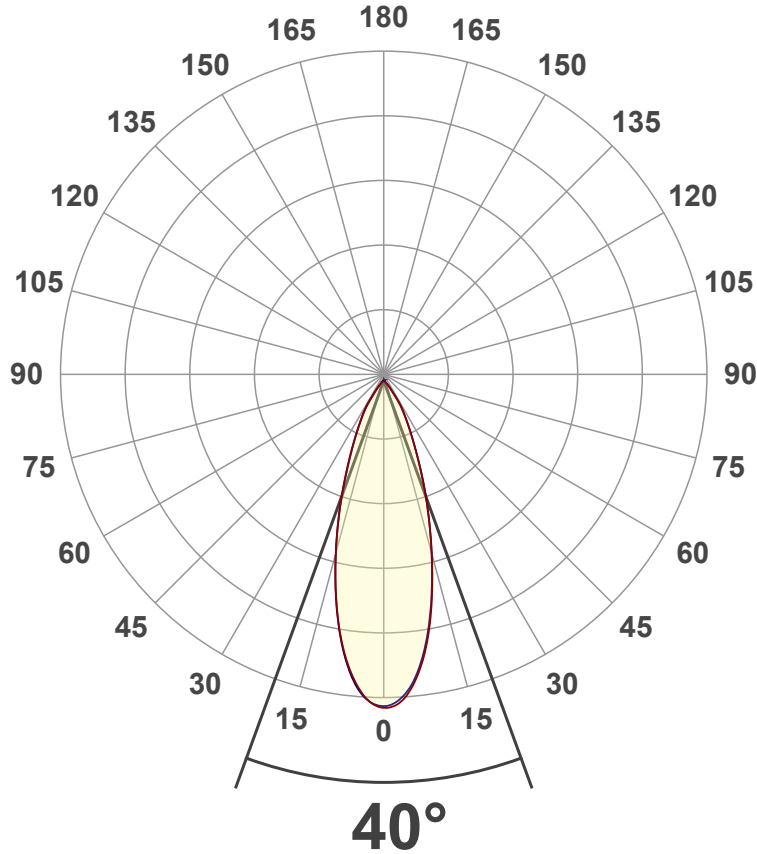

Main Values

Output (total Lumen)	800 lm
Lumen Up% / Down%	0% / 100%
Peak Intensity	1851 cd
Beam Angle (50%)	40°
Beam Angle (90%)	34.1°
Beam Angle (10%)	34°

Cut-off Angle

Average 2,5%	85.7°
--------------	-------

Field Angle

Average 10%	67.9°
-------------	-------

Intensity Ratio

In 120° cone	99.3%
In 90° cone	96.8%

C000-C180
C090-C270

Linear distribution diagram - Intensity (candela) vs γ -angle

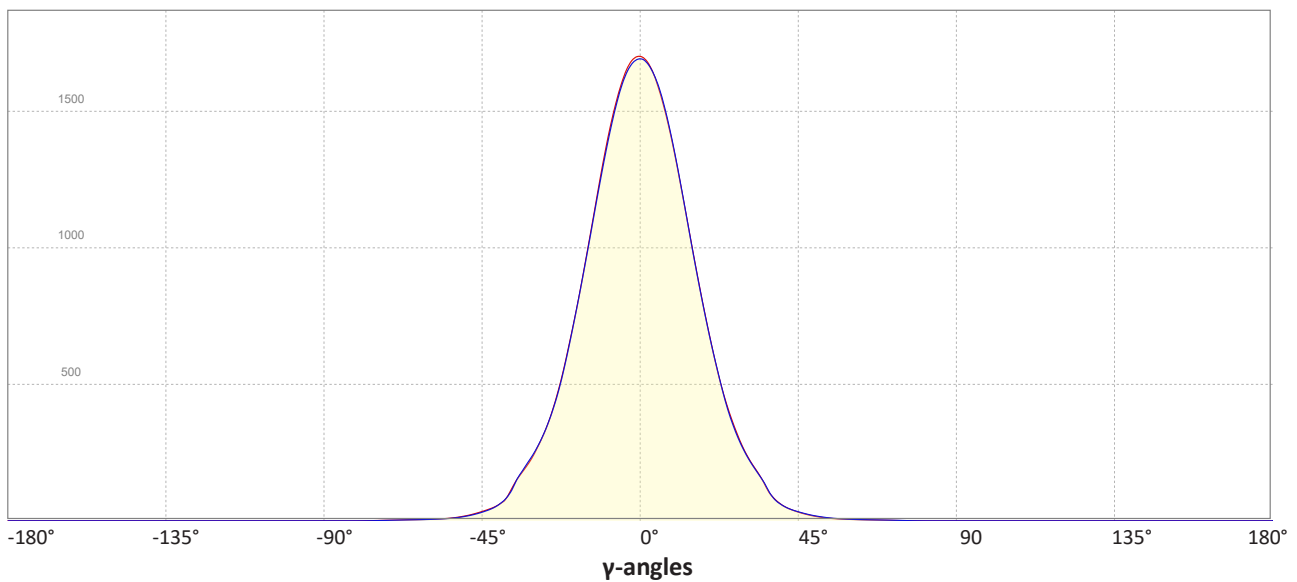

Light Measurement Report

Print date: 2023-01-06

Measurement date and time: 2023-01-06 12:18:03 PM – Measurement no. VFR-230106-0052-MS

Color details

Correlated Color Temperature, Target CCT = 3000 K
 Correlated Color Temperature, Measured CCT = 2937 K
 Color Rendering Index CRI 92.8
 Color Rendering Index, R9 (red component) R9 = 55.6
 Color Rendering TM30-18 Rf 89.2 – Rg 94.1
 Color Quality Scale CQS = 89.8

MacAdam Steps
 Color coordinates CIE 1931 (x;y) = (0.437;0.404)
 Color coordinate CIEs 1960 (u;v) = (0.251;0.348)
 Color deviation from BBL Duv = 0.0035
 Color coordinate CIEs 1976 (CIELUV) (u';v') = (0.251;0.251)

CIE 1931

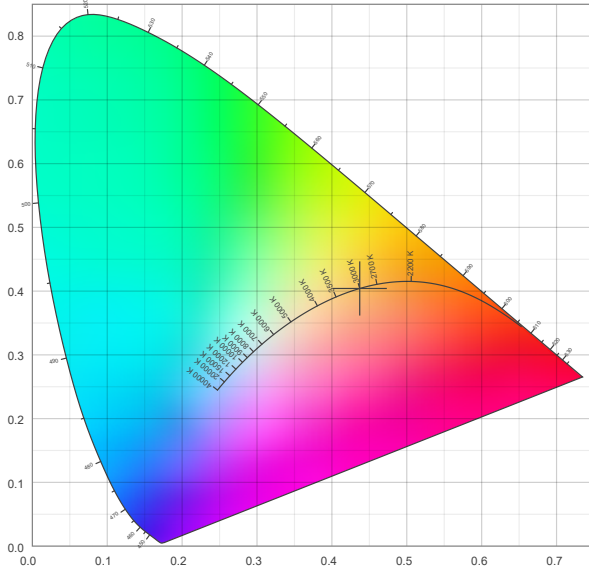

CIE 1931 – zoomed on Planckian locus

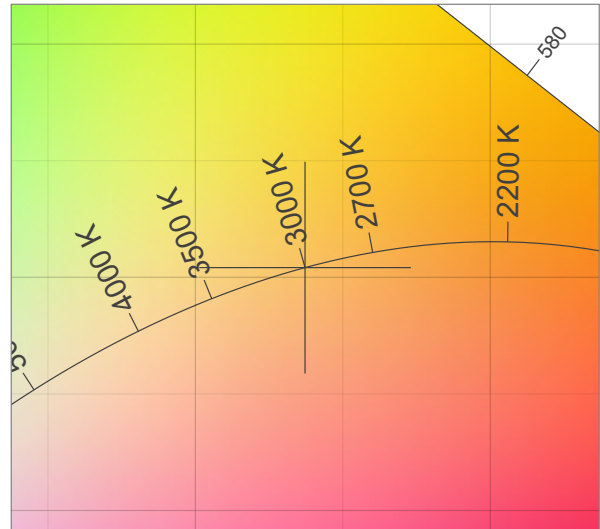

Color Rendering Index per reference color (CIE 1995)

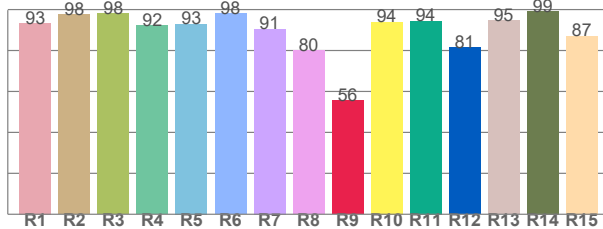

CRI R values, only R1-R8 are used to calculate final CRI value

R1	R2	R3	R4	R5	R6	R7	R8	R9	R10	R11	R12	R13	R14	R15
93.4	97.5	98.0	92.1	93.0	98.1	90.6	79.9	55.6	94.0	94.4	81.5	94.7	99.2	87.1

Spectral power distribution (SPD) / W/nm – 0-100%

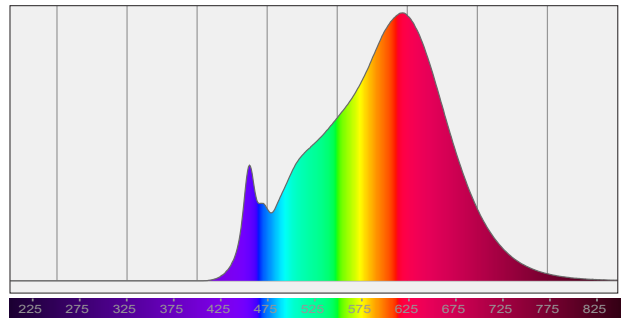

TM30-18 Rf-values per hue bin

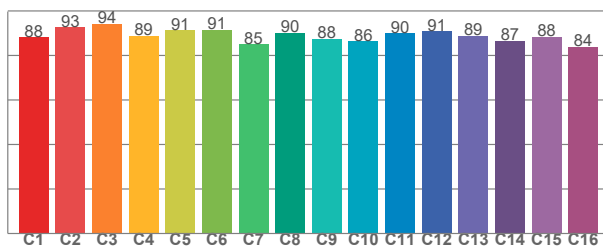

TM30 C values, 16 binned values out of total of 99 C values

C1	C2	C3	C4	C5	C6	C7	C8	C9	C10	C11	C12	C13	C14	C15	C16
88.1	92.6	94.3	89.0	91.4	91.5	85.0	90.2	87.6	86.5	89.9	90.8	88.8	86.7	88.3	83.9

Color Quality Scale by reference color

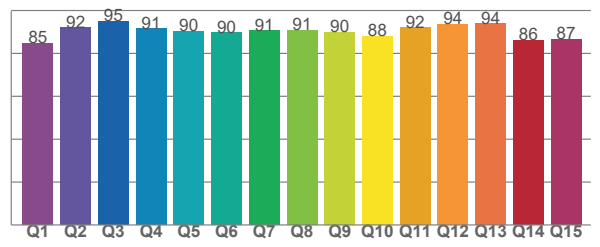

CQS Q values

Q1	Q2	Q3	Q4	Q5	Q6	Q7	Q8	Q9	Q10	Q11	Q12	Q13	Q14	Q15
84.7	91.9	94.8	91.5	90.3	89.6	90.6	90.8	89.7	88.0	91.9	93.6	93.8	86.1	86.5

Light Measurement Report

Print date: 2023-01-06

Measurement date and time: 2023-01-06 12:18:03 PM – Measurement no. VFR-230106-0052-MS

Beam Details

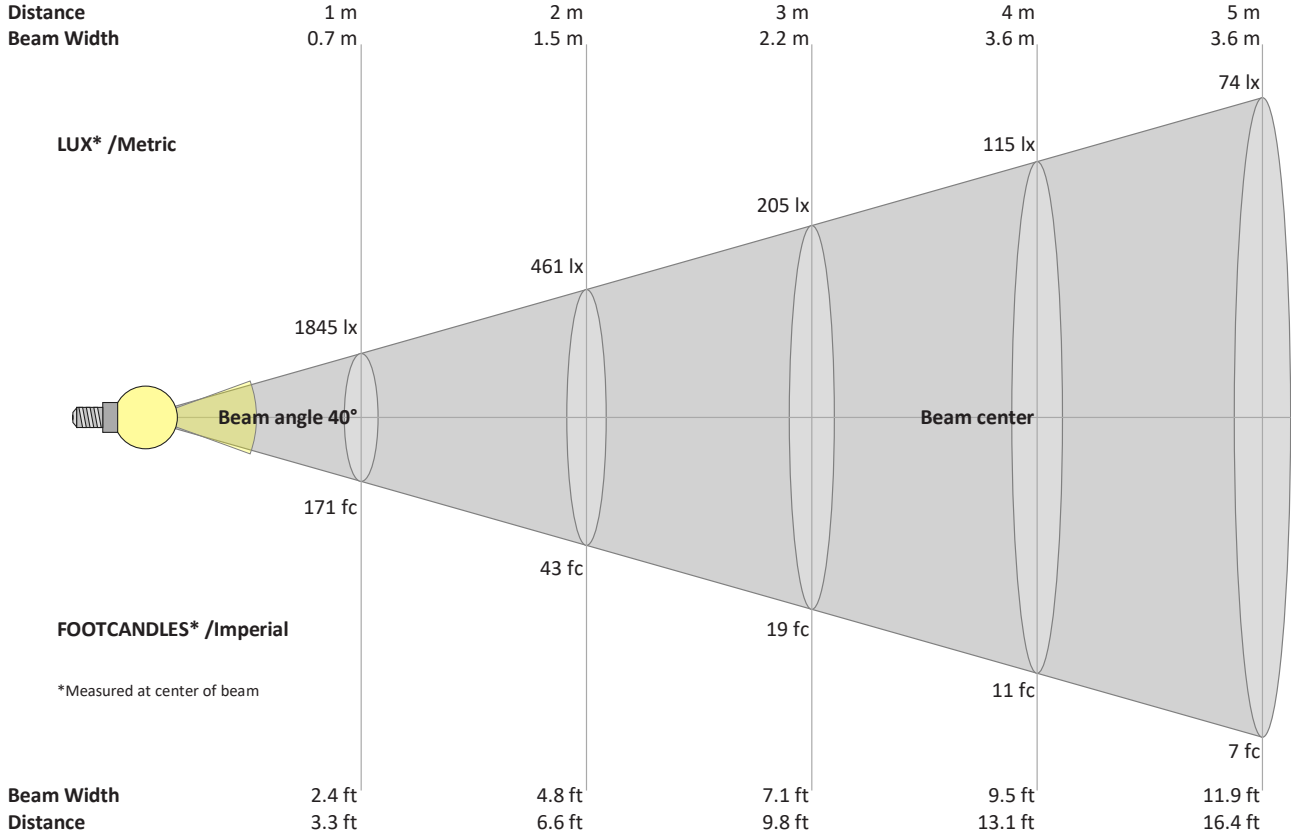

Beam intensities from 1 – 20 m

1	2	3	4	5	6	7	8	9	10	11	12	13	14	15	16	17	18	19	20	m
3.3	6.6	9.8	13.1	16.4	19.7	23	26.2	29.5	32.8	36.1	39.4	42.7	45.9	49.2	52.5	55.8	59.1	62.3	65.6	ft
1845	461	205	115	74	51	38	29	23	18	15	13	11	9	8	7	6	6	5	5	lux
171.4	42.8	19	10.7	6.9	4.8	3.5	2.7	2.1	1.7	1.4	1.2	1	0.9	0.8	0.7	0.6	0.5	0.5	0.4	fc

Intensities in 0° c-plane

0°	2°	4°	6°	8°	10°	12°	14°	16°	18°	20°	22°	24°	26°	28°	30°	32°	34°	36°	38°	y
1845	1839	1794	1711	1602	1470	1317	1158	1002	854	718	592	486	398	329	272	225	186	143	94	cd
100%	100%	97%	93%	87%	80%	71%	63%	54%	46%	39%	32%	26%	22%	18%	15%	12%	10%	8%	5%	of 0°val

Intensities in 90° c-plane

0°	2°	4°	6°	8°	10°	12°	14°	16°	18°	20°	22°	24°	26°	28°	30°	32°	34°	36°	38°	y
1845	1823	1776	1696	1586	1454	1305	1149	996	853	720	600	490	399	326	269	221	179	134	91	cd
100%	99%	96%	92%	86%	79%	71%	62%	54%	46%	39%	33%	27%	22%	18%	15%	12%	10%	7%	5%	of 0°val

Intensities in 180° c-plane

0°	2°	4°	6°	8°	10°	12°	14°	16°	18°	20°	22°	24°	26°	28°	30°	32°	34°	36°	38°	y
1845	1830	1773	1687	1579	1448	1302	1151	999	856	722	599	494	407	334	272	224	181	131	91	cd
100%	99%	96%	91%	86%	79%	71%	62%	54%	46%	39%	32%	27%	22%	18%	15%	12%	10%	7%	5%	of 0°val

Intensities in 270° c-plane

0°	2°	4°	6°	8°	10°	12°	14°	16°	18°	20°	22°	24°	26°	28°	30°	32°	34°	36°	38°	y
1845	1827	1780	1698	1588	1454	1306	1151	998	852	714	588	482	397	331	277	232	189	138	92	cd
100%	99%	96%	92%	86%	79%	71%	62%	54%	46%	39%	32%	26%	22%	18%	15%	13%	10%	8%	5%	of 0°val