

VEROBOARD®

LED Step Light with Motion Sensor and Photocell



These contemporary step and wall lights automatically turn ON when they sense darkness with an additional motion-activated feature. And automatically turn OFF during the daytime or when there is no motion detected. There are many locations where you might want to install these lights, along pathways, on stairs, deck, patio, and so on, to name a few. Moreover, they are suitable for both indoor and outdoor spaces. They are not limited to wet locations but can also be installed for indoor stair tread, hallway lighting, and other similar applications. These modern step lights easily fit into a standard rectangular outlet box. They come in both white and black finish.

SPECIFICATIONS

Engine Model No.	LSD033KWH
Voltage	120V AC
Wattage	3W
Frequency	60Hz
Incandescent Equivalent	25W
Color Temperature	3000K (Warm White)
Dimmable	No
Brightness	100 Lumens
Rendering Index	CRI>90
LED Type	Integrated LED
Engine Material	PVC
Face Plate Material	Die-Cast Aluminum
Available Face Plate Colors	White
Rated Life	50,000 Hours
Beam Angle	80°
Installation	Outlet Box Recessed
IP Rating	IP65 (Wet Locations)
Outer Dimensions	120 x 76 x 27 mm x (4.7 x 3 x 1.06 in)
Outlet Box Dimensions	52 x 102 mm (2 x 4 in)
Package Dimensions	13 x 8.4 x 5.7 cm (5.14 x 3.32 x 2.25 in)
Package Weight	0.208 Kg
Certification	FCC/ETL/Energy Star/ RoHS

Included Content:

- 1x Step Light Engine
- 1x Face Plate
- 1x Installation Instruction Manual
- 3x Wire Connectors
- 2x Mounting Screws
- 1x Hexagon Socket Screw
- 1x Allen Key



Safety and Warning

The fixture must be wired in accordance with local and national electrical codes and standards. And all the installation must be done by a certified electrician. Please be sure the main power switch is OFF before the installation, inspection, or removal. It is strictly necessary to ground the outlet box properly. Furthermore, the integrated LEDs in the light fixture can not be replaced.

Name: _____

Quantity: _____

Phone: _____

Email: _____

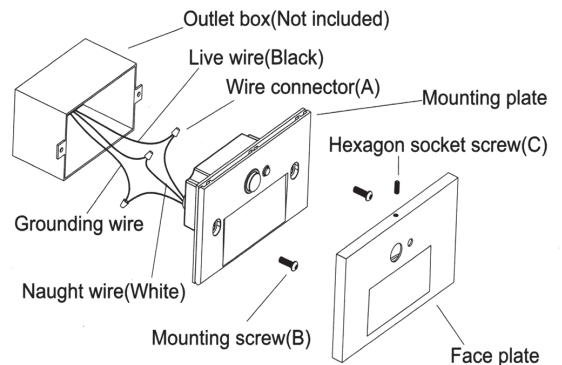
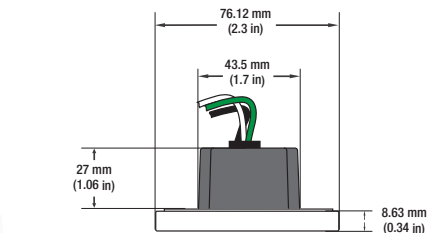
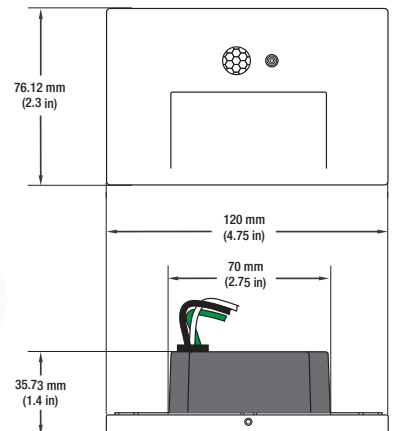
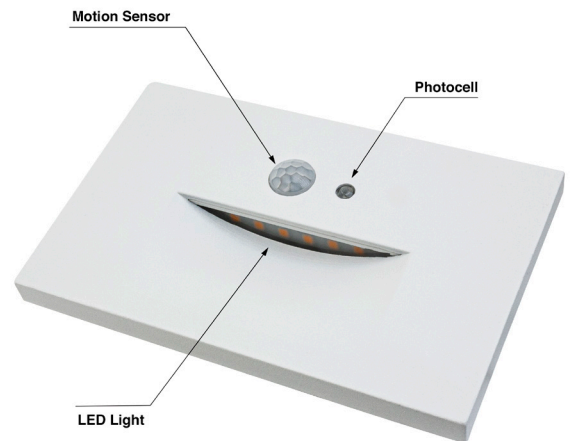

Light Measurement Report

Print date: 2023-02-01

Measurement date and time: 2023-02-01 1:13:38 PM – Measurement no. VFR-230201-0038-MS

Luminous Intensity diagram

Unit: 0-100% of peak intensity

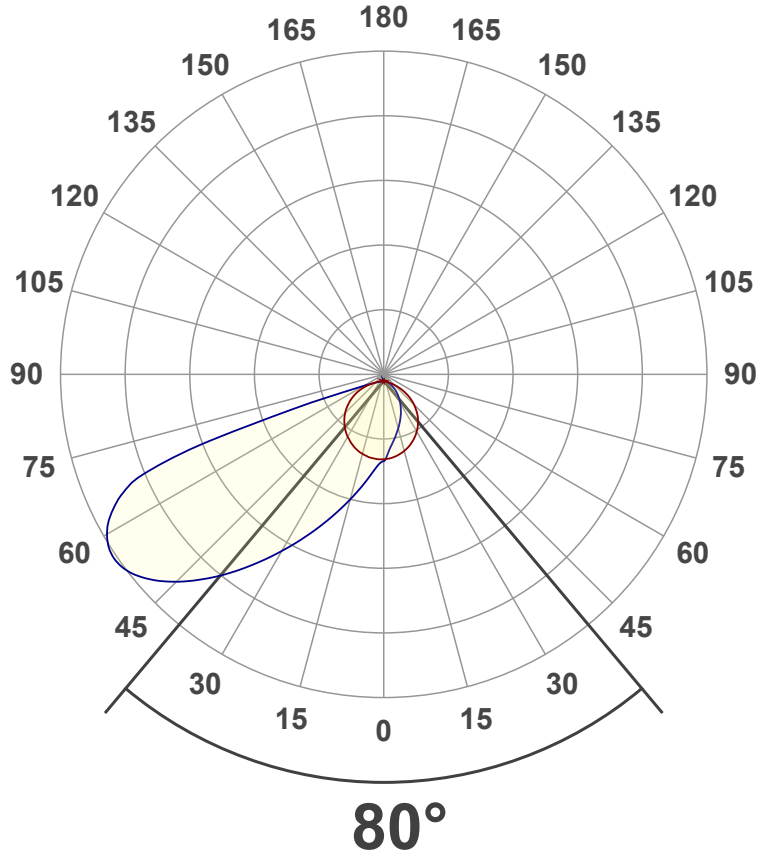

Main Values

Output (total Lumen)	100 lm
Lumen Up% / Down%	0.06% / 99.94%
Peak Intensity	47.2 cd
Beam Angle (50%)	80°
Beam Angle (90%)	46.9°
Beam Angle (10%)	112°

Cut-off Angle

Average 2,5%	150.3°
--------------	--------

Field Angle

Average 10%	129.3°
-------------	--------

Intensity Ratio

In 120° cone	72.7%
In 90° cone	40.2%

C000-C180
C090-C270

Linear distribution diagram - Intensity (candela) vs γ -angle

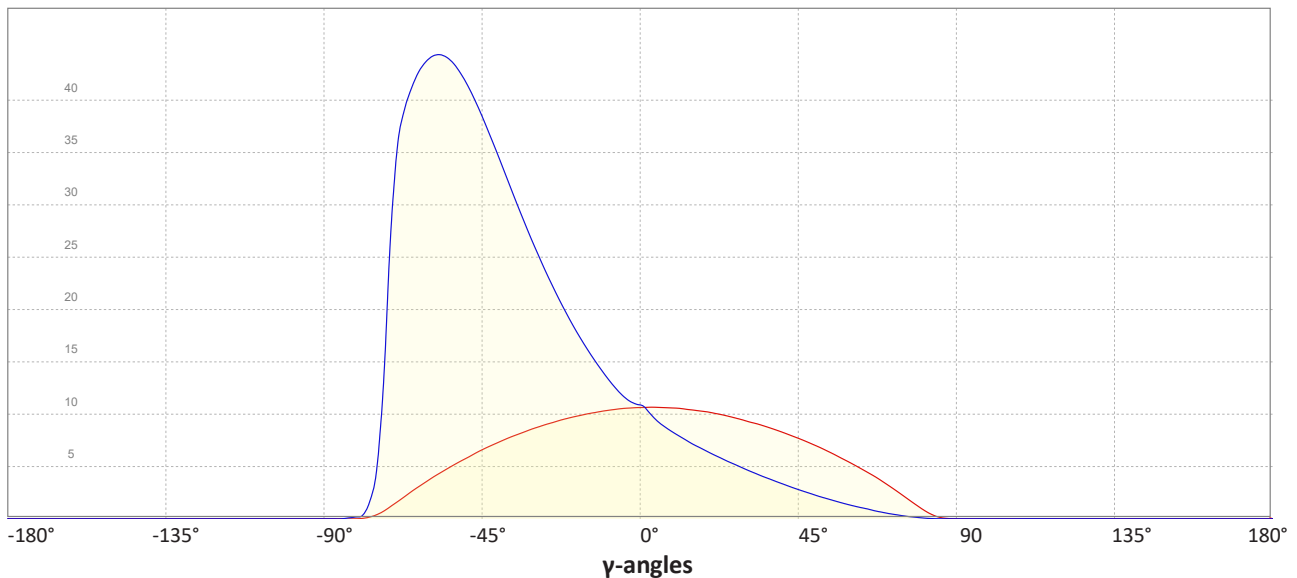

Light Measurement Report

Print date: 2023-02-01

Measurement date and time: 2023-02-01 1:13:38 PM – Measurement no. VFR-230201-0038-MS

Color details

Correlated Color Temperature, Target CCT = 3000 K
 Correlated Color Temperature, Measured CCT = 2825 K
 Color Rendering Index CRI 92.2
 Color Rendering Index, R9 (red component) R9 = 42.4
 Color Rendering TM30-18 R_f 89.6 – R_g 101.3
 Color Quality Scale CQS = 88.5

MacAdam Steps
 Color coordinates CIE 1931 (x;y) = (0.437;0.404)
 Color coordinate CIEs 1960 (u';v) = (0.251;0.348)
 Color deviation from BBL Duv = -0.0032
 Color coordinate CIEs 1976 (CIELUV) (u';v') = (0.251;0.251)

CIE 1931



CIE 1931 – zoomed on Planckian locus

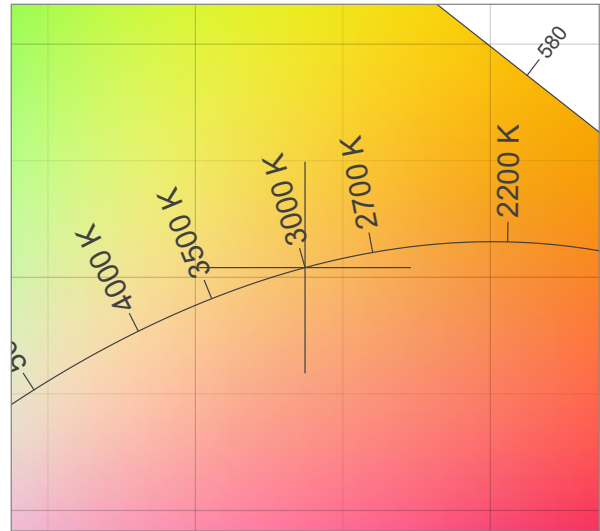

Color Rendering Index per reference color (CIE 1995)

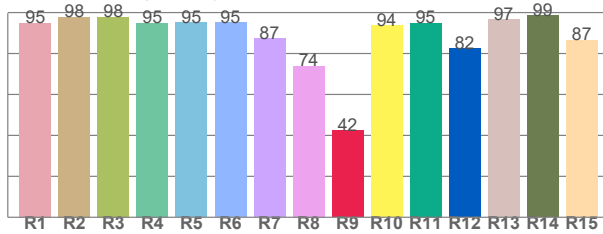

CRI R values, only R1-R8 are used to calculate final CRI value

R1	R2	R3	R4	R5	R6	R7	R8	R9	R10	R11	R12	R13	R14	R15
95.0	97.8	97.9	95.0	95.3	95.1	87.4	74.0	42.4	93.8	95.0	82.4	96.7	98.5	86.6

Spectral power distribution (SPD) / W/nm – 0-100%

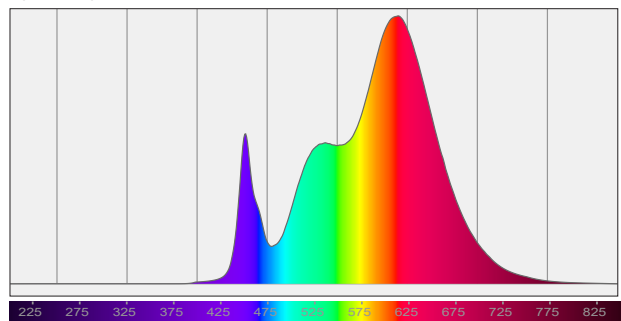

TM30-18 Rf-values per hue bin

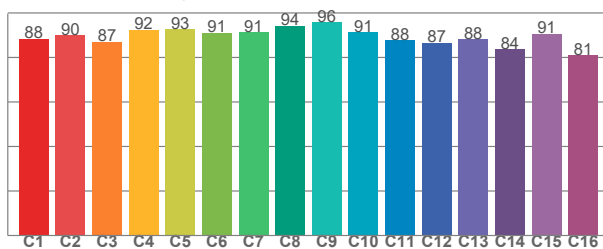

TM30 C values, 16 binned values out of total of 99 C values

C1	C2	C3	C4	C5	C6	C7	C8	C9	C10	C11	C12	C13	C14	C15	C16
88.4	90.0	87.0	92.4	92.6	91.1	91.4	94.1	95.8	91.3	87.7	86.7	88.1	83.6	90.7	80.9

Color Quality Scale by reference color

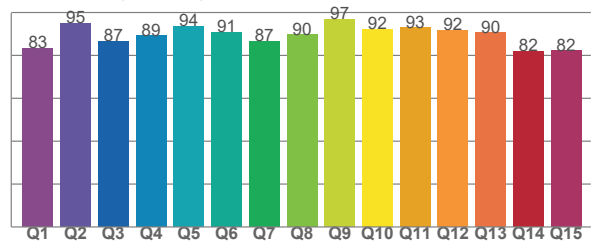

CQS Q values

Q1	Q2	Q3	Q4	Q5	Q6	Q7	Q8	Q9	Q10	Q11	Q12	Q13	Q14	Q15
83.4	95.1	86.7	89.2	93.5	90.7	86.5	89.5	96.8	92.3	92.9	91.7	90.5	82.0	82.2

Light Measurement Report

Print date: 2023-02-01

Measurement date and time: 2023-02-01 1:13:38 PM – Measurement no. VFR-230201-0038-MS

Beam Details

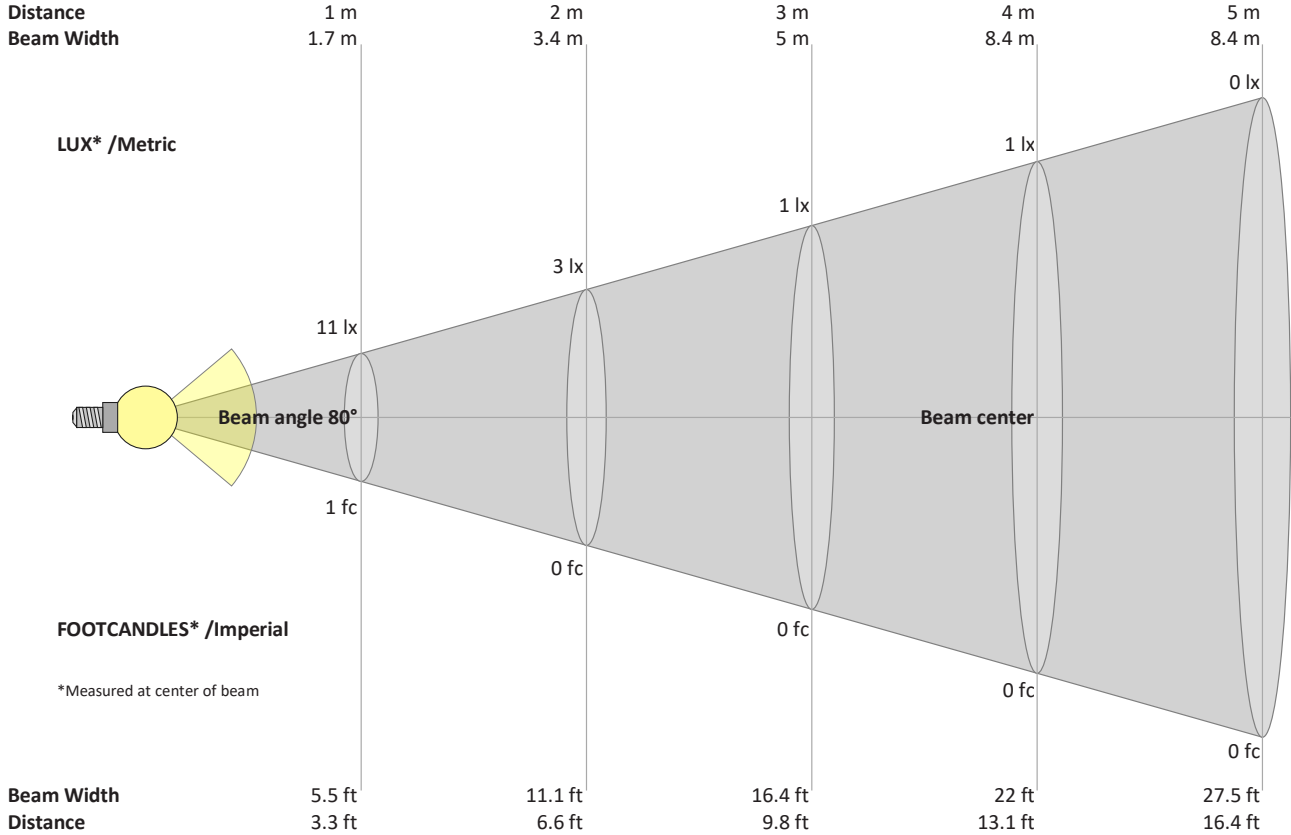

Beam intensities from 1 – 20 m

1	2	3	4	5	6	7	8	9	10	11	12	13	14	15	16	17	18	19	20	m	
3.3	6.6	9.8	13.1	16.4	19.7	23	26.2	29.5	32.8	36.1	39.4	42.7	45.9	49.2	52.5	55.8	59.1	62.3	65.6	ft	
11	3	1	1	0	0	0	0	0	0	0	0	0	0	0	0	0	0	0	0	0	lux
1.1	0.3	0.1	0.1	0	0	0	0	0	0	0	0	0	0	0	0	0	0	0	0	0	fc

Intensities in 0° c-plane

0°	5°	10°	15°	20°	25°	30°	35°	40°	45°	50°	55°	60°	65°	70°	75°	80°	85°	90°	95°	y	
11.4	11.2	11.0	10.7	10.3	9.8	9.2	8.6	7.8	7.0	6.1	5.1	4.0	2.8	1.5	0.4	0.0	0.0	0.0	0.0	0.0	cd
100%	98%	96%	93%	90%	86%	81%	75%	69%	61%	53%	44%	35%	24%	13%	4%	0%	0%	0%	0%	0%	of 0°val

Intensities in 90° c-plane

0°	5°	10°	15°	20°	25°	30°	35°	40°	45°	50°	55°	60°	65°	70°	75°	80°	85°	90°	95°	y	
11.4	9.9	8.7	7.6	6.7	5.8	5.0	4.3	3.6	3.0	2.4	1.9	1.4	1.0	0.6	0.3	0.1	0.0	0.0	0.0	0.0	cd
100%	87%	76%	66%	58%	51%	44%	38%	32%	26%	21%	16%	12%	9%	5%	3%	1%	0%	0%	0%	0%	of 0°val

Intensities in 180° c-plane

0°	5°	10°	15°	20°	25°	30°	35°	40°	45°	50°	55°	60°	65°	70°	75°	80°	85°	90°	95°	y	
11.4	11.3	11.3	11.1	10.8	10.4	10.0	9.5	8.9	8.2	7.4	6.6	5.7	4.7	3.6	2.3	1.1	0.2	0.0	0.0	0.0	cd
100%	99%	98%	97%	95%	91%	87%	83%	78%	72%	65%	58%	50%	41%	31%	20%	9%	2%	0%	0%	0%	of 0°val

Intensities in 270° c-plane

0°	5°	10°	15°	20°	25°	30°	35°	40°	45°	50°	55°	60°	65°	70°	75°	80°	85°	90°	95°	y	
11.4	12.5	14.6	17.2	20.2	23.7	27.7	32.0	36.5	40.9	44.6	46.9	46.8	43.9	33.6	5.0	0.3	0.0	0.0	0.0	0.0	cd
100%	110%	128%	151%	177%	207%	242%	279%	319%	358%	390%	410%	409%	384%	294%	44%	2%	0%	0%	0%	0%	of 0°val