



ROUND CEILING LIGHT 12V, 8.2W, 4000K (NATURAL WHITE)

Specifications

Model No.:	DL1603
Input Voltage:	12V DC
Wattage:	8.2W
Color Temperature:	4000K (Natural White)
Brightness:	500Lm
Beam Angel:	45°
Body Color:	White
Material:	Aluminum
Rendering Index:	CRI>80
IP rating:	IP20 (Indoor rated)
Dimensions:	Diameter: 110 mm (4.3") Depth: 117mm (4.6")
Wire Size:	500 mm (19.6") 20AWG
Certification:	CE



SKU: 666561411015

Features

- 8.2W wattage for brightness and energy efficiency.
- 4000K color temperature, providing warm white illumination.
- 500Lm luminous flux for ample brightness.
- Luminous Flux: 500Lm, ensuring ample brightness to light up your surroundings.
- High-quality aluminum construction in clean white color.
- IP20 rating for indoor use with solid object and splash protection.
- Certified and meets high-quality standards.
- Ideal for residential or commercial applications.

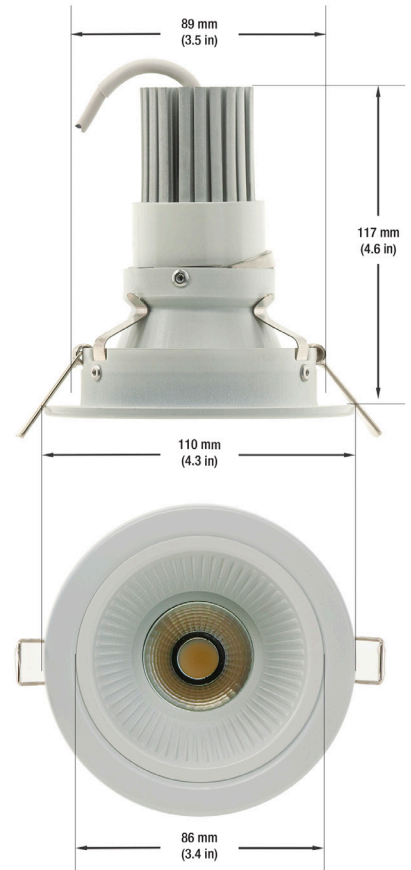

Disclaimer

The data and information contained in this specification sheet are subject to change without notice; the ratings supplied are provided based on the product manufacturer. The information contained in this specification sheet should not be considered a warranty, expressed or implied, including, but not limited to, a warranty of merchantability or fitness for a particular purpose. In no event shall LED Lights and Parts be liable for any incidental or consequential damages resulting from the use, misuse, or inability to use the product. This exclusion applies regardless of whether such damages are sought based on breach of warranty, breach of contract, negligence, strict liability in tort, or any other legal theory.



LED Lights and Parts

WORLD OF LED LIGHTS

Light efficiency:

40 Lumen/Watt

Light quality:

CRI: 84.6

Color temperature:

4000 K

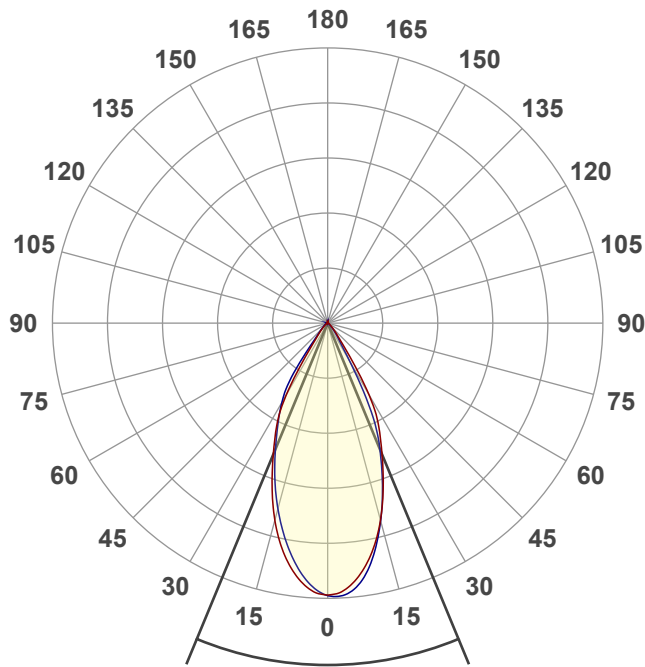

Beam angle

45°

Color



CIE1931
x: 0.397
y: 0.384

Spectra

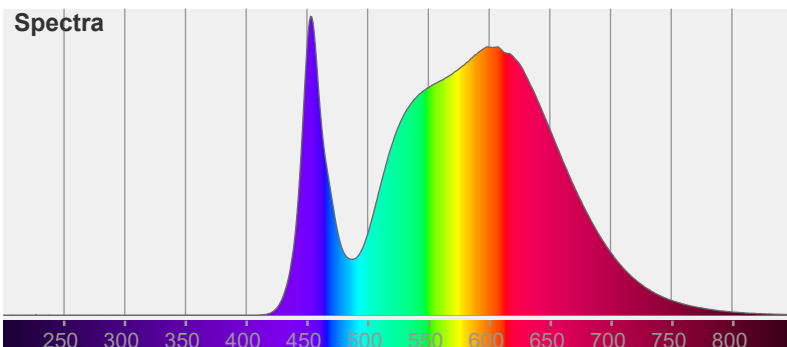

Power

Voltage: 117 V
Current: 0.210 A

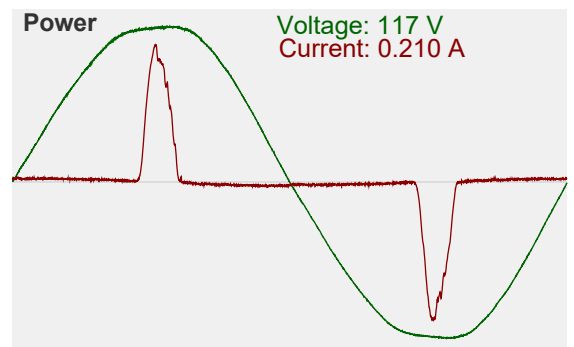

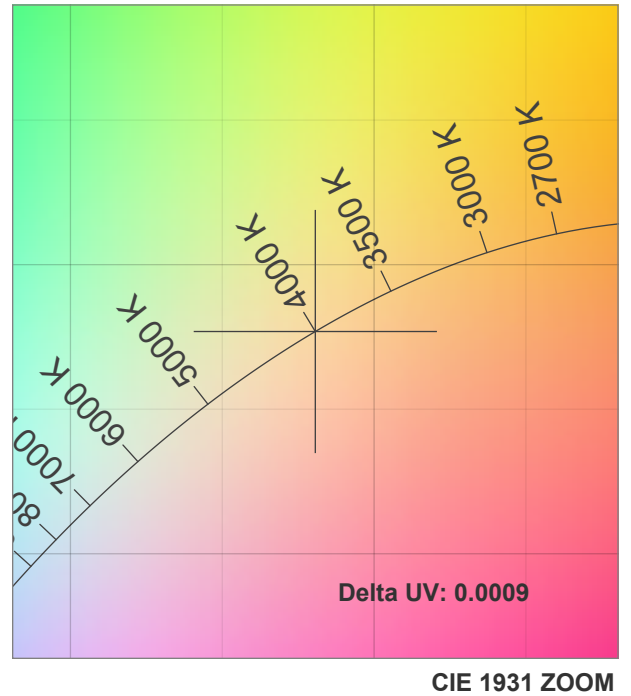
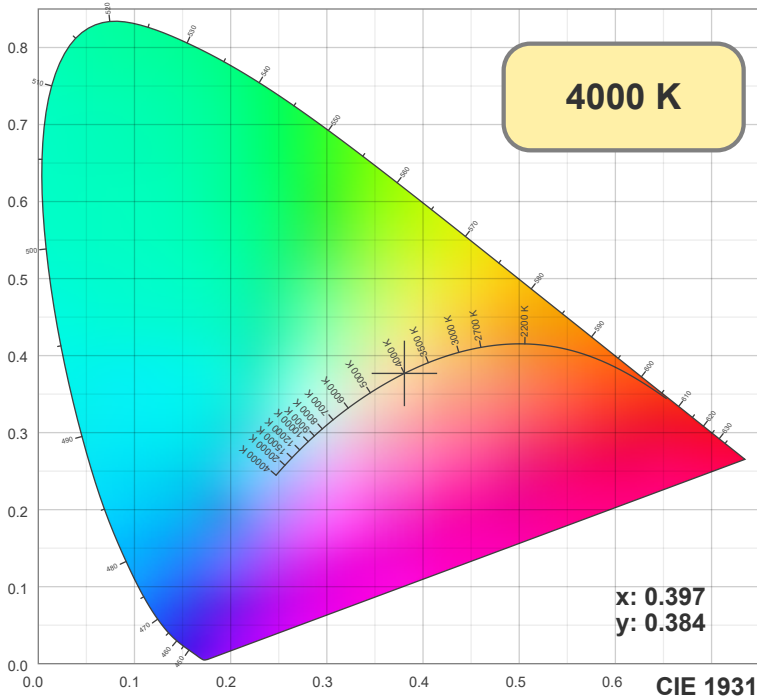

TM30: 83.4

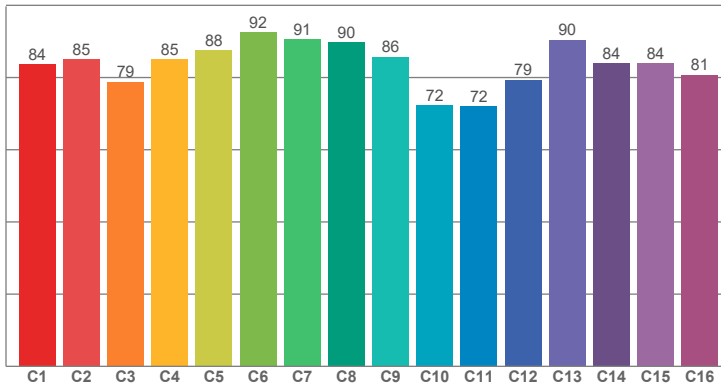

CRI: 84.6 (R1-R8)

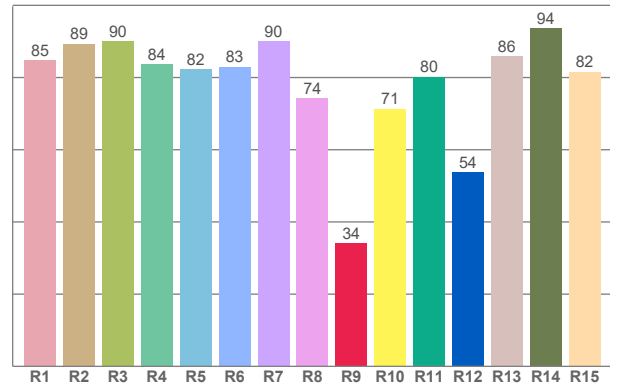

CRI R values, only R1-R8 are used to calculate final CRI value

R1	R2	R3	R4	R5	R6	R7	R8	R9	R10	R11	R12	R13	R14	R15
84.71	89.32	90.07	83.64	82.27	82.94	89.94	74.23	34.11	71.36	80.17	53.69	85.82	93.67	81.52

TM30 C values, 16 binned values out of total of 99 C values

C1	C2	C3	C4	C5	C6	C7	C8	C9	C10	C11	C12	C13	C14	C15	C16
83.57	84.97	78.78	84.99	87.54	92.44	90.51	89.74	85.77	72.28	72.03	79.30	90.42	83.88	83.89	80.75

CQS Q values

Q1	Q2	Q3	Q4	Q5	Q6	Q7	Q8	Q9	Q10	Q11	Q12	Q13	Q14	Q15
86.62	98.46	74.00	70.73	78.31	81.58	83.46	88.32	94.81	85.95	83.52	84.84	86.43	79.86	82.24

CQS: 82.6

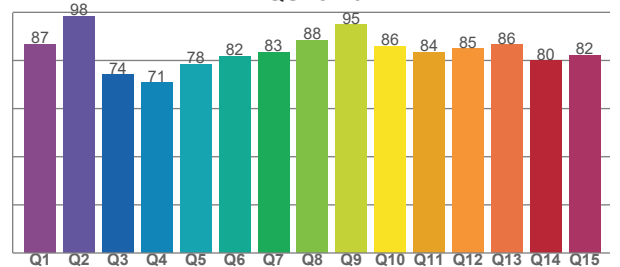

Color parameters

CCT	CRI	CRI R9	TM30 Rf	TM30 Rg	CQS	x	y	u	v	Duv
4000 K	84.6	34.1	83.4	97.3	82.6	0.4	0.4	0.2	0.3	-0.0009

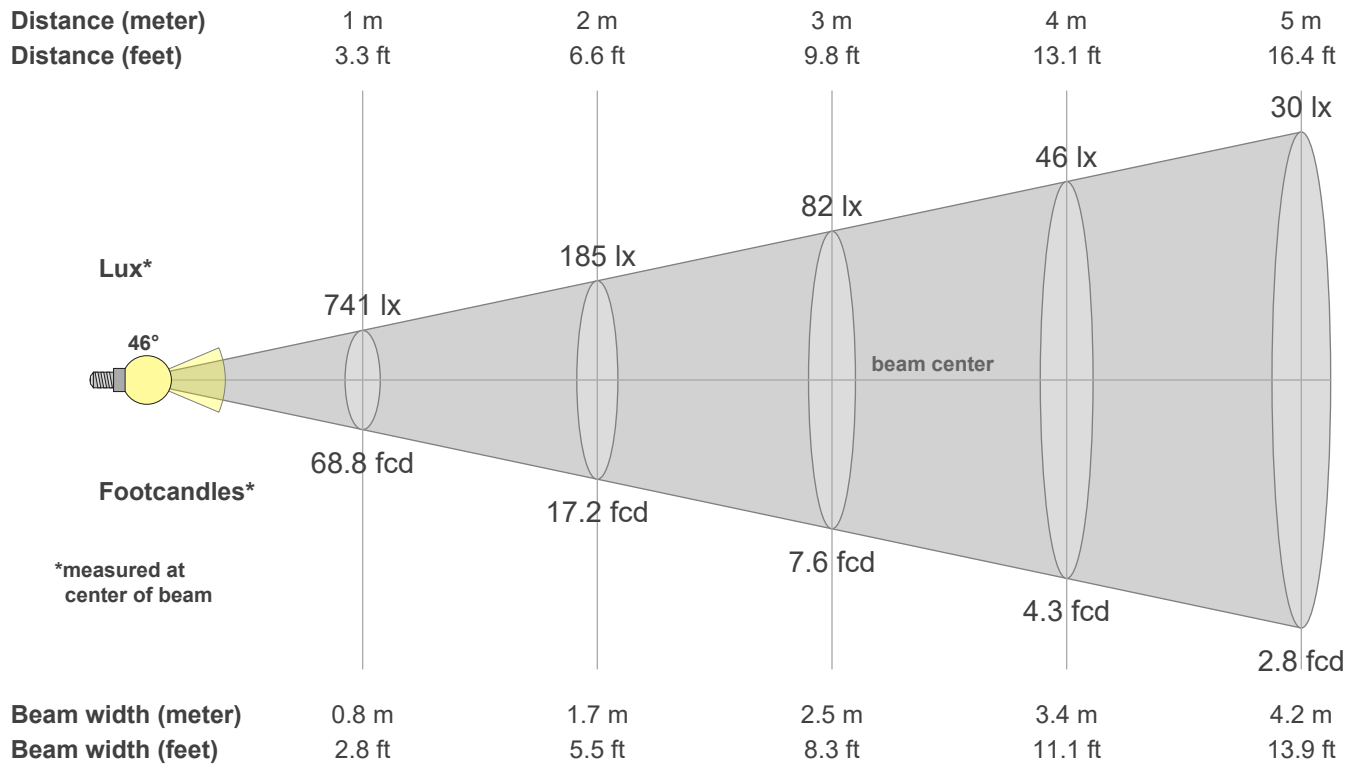

Intensities in 0° c-plane

0°	2°	4°	6°	8°	10°	12°	14°	16°	18°	20°	22°	24°	26°	28°	30°	32°	34°	36°	38°
741	736	725	706	681	651	616	576	533	488	442	398	357	319	279	224	156	99	64	46
100%	99%	98%	95%	92%	88%	83%	78%	72%	66%	60%	54%	48%	43%	38%	30%	21%	13%	9%	6%

Intensities in 90° c-plane

0°	2°	4°	6°	8°	10°	12°	14°	16°	18°	20°	22°	24°	26°	28°	30°	32°	34°	36°	38°
741	744	739	725	701	667	626	581	533	483	433	383	335	275	198	124	78	56	42	32
100%	100%	100%	98%	95%	90%	85%	78%	72%	65%	58%	52%	45%	37%	27%	17%	10%	8%	6%	4%

Intensities in 180° c-plane

0°	2°	4°	6°	8°	10°	12°	14°	16°	18°	20°	22°	24°	26°	28°	30°	32°	34°	36°	38°
741	736	725	706	681	651	616	576	533	488	442	398	357	319	279	224	156	99	64	46
100%	99%	98%	95%	92%	88%	83%	78%	72%	66%	60%	54%	48%	43%	38%	30%	21%	13%	9%	6%

Intensities in 270° c-plane

0°	2°	4°	6°	8°	10°	12°	14°	16°	18°	20°	22°	24°	26°	28°	30°	32°	34°	36°	38°
741	730	711	685	654	620	582	543	503	463	422	381	344	310	279	249	217	171	110	65
100%	99%	96%	93%	88%	84%	79%	73%	68%	62%	57%	51%	46%	42%	38%	34%	29%	23%	15%	9%

Beam angle 50%	Field angle 10%	Cutoff angle 2.5%	Intensity ratio in 120° cone	Intensity ratio in 90° cone
45.8°	70.2°	90.4°	98.2%	95.3%