

Name: _____

Company: _____

Phone: _____

Email: _____

VBD-MTR-13C Light Fixture 2.5" Round Recessed Downlight

SPECIFICATIONS



| | |
|---------------------------------|---|
| Model No. | VBD-MTR-13C |
| Trim Color | Polished Chrome |
| Trim Material | High-Quality Aluminum |
| Trim Shape | Round |
| Compatible Light Engines | VBD-TR5-W (2400K • 2700K • 3000K • 3500K • 4000K • 5000K) VBD-TR4-RGBW |
| Outer Diameter | 94mm (3.7") |
| Cut Size | 64.16mm (2.5") |
| Depth | 23.30mm (0.91") |

SKU: 666561407421

Features

- Widely used by interior designers.
- This VBD-MTR-13C light fixture is compatible to work with our VBD-TR Series Light engines.
- Contact us for more assistance and to know more about bulk orders.

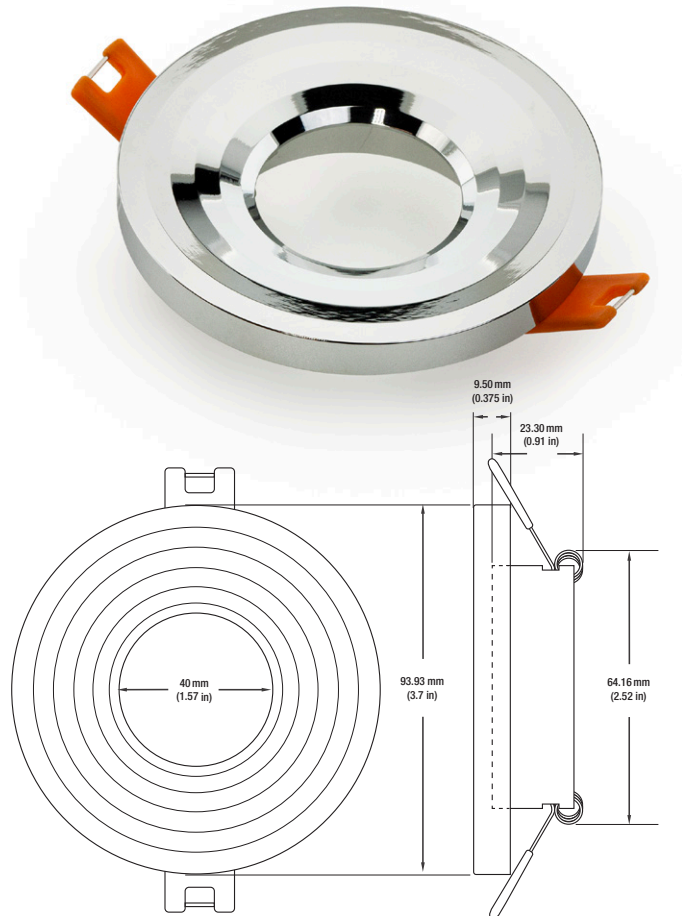

VBD-TR5-W (Frosted Glass)

| | |
|-----------------------------|-------------------------------|
| Model No. | VBD-TR5-W-FG |
| Input Voltage | 12V DC |
| Wattage | 5W |
| Body Colour | Metallic Silver |
| Available Trim Color | Silver • White • Black • Gold |
| Diffuser Material | Frosted Glass |
| Fixture Material | Aluminum |
| Beam Angle | 110° |
| Rendering Index | CRI>90 |
| IP Rating | IP20 (Damp Location) |
| Dimensions | 49mm x 28.5mm (1.93" x 1.12") |



Beam Details

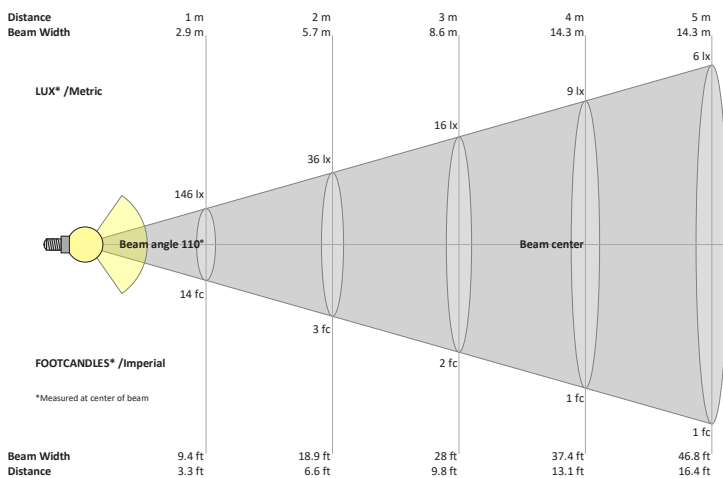

Available Colour Temperatures

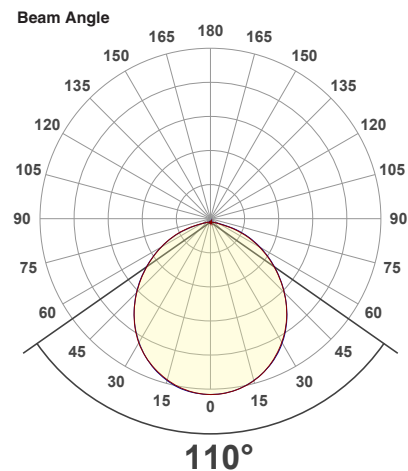

ORDERING GUIDE

Example part number: **VBD-TR5-W-FG-24K-S**

MODEL: VBD - SERIES: TR5-W - DIFFUSER: FG - COLOUR: 24K - TRIM COLOUR: S

COLOUR options: 24K, 35K, 27K, 40K, 30K, 50K

TRIM COLOUR options: S (Silver), B (Black), G (Gold), W (White)

NOTES:
 FG = Frosted Glass
 S = Silver
 G = Gold
 B = Black
 W = White



VBD-TR5-W (Clear Lens)

| | |
|----------------------|-------------------------------|
| Model No. | VBD-TR5-W-L |
| Input Voltage | 12V DC |
| Wattage | 5W |
| Body Colour | Metallic Silver |
| Available Trim Color | Silver • White • Black • Gold |
| Diffuser Material | Clear Lens |
| Fixture Material | Aluminum |
| Beam Angle | 35° |
| Rendering Index | CRI>90 |
| IP Rating | IP20 (Damp Location) |
| Dimensions | 49mm x 28.5mm (1.93" x 1.12") |



Available Colour Temperatures



Beam Details

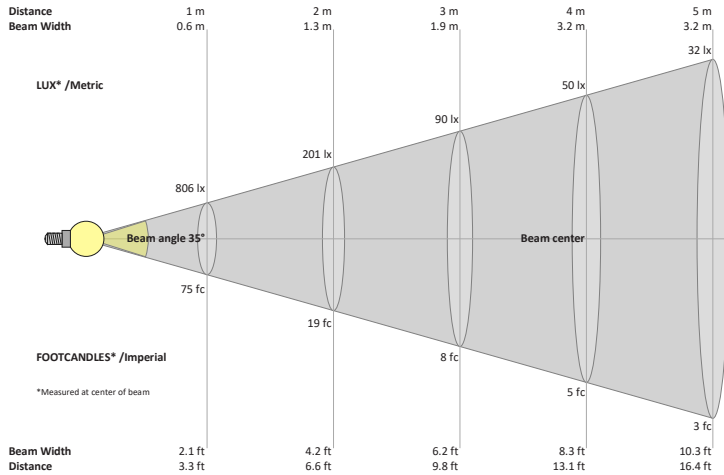

Beam Angle

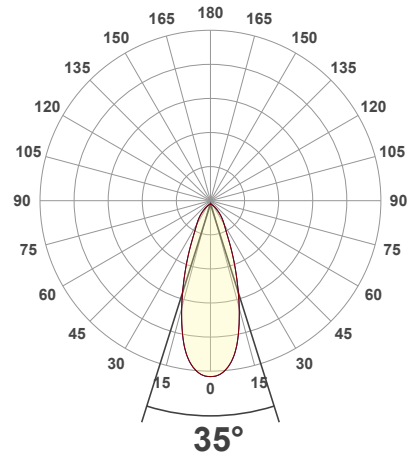

ORDERING GUIDE

Example part number: **VBD-TR5-W-L-24K-S**

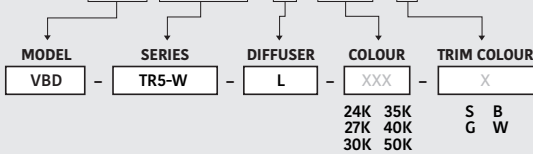

NOTES:

L = Clear Lens
S = Silver
G = Gold
B = Black
W = White



VBD-TR4-RGBW (Frosted Glass)

| | |
|----------------------|-------------------------------|
| Model No. | VBD-TR4-RGBW-FG |
| Input Voltage | 12V DC |
| Wattage | 4W |
| Color Temperature | RGBW |
| Body Colour | Metallic Silver |
| Available Trim Color | Silver • White • Black • Gold |
| Diffuser Material | Frosted Glass |
| Fixture Material | Aluminum |
| Beam Angle | 110° |
| Rendering Index | CRI>80 |
| IP Rating | IP20 (Damp Location) |
| Dimensions | 49mm x 28.5mm (1.93" x 1.12") |

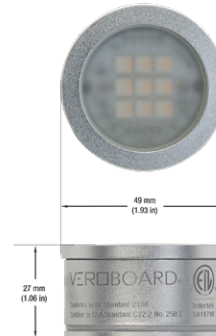

Beam Details

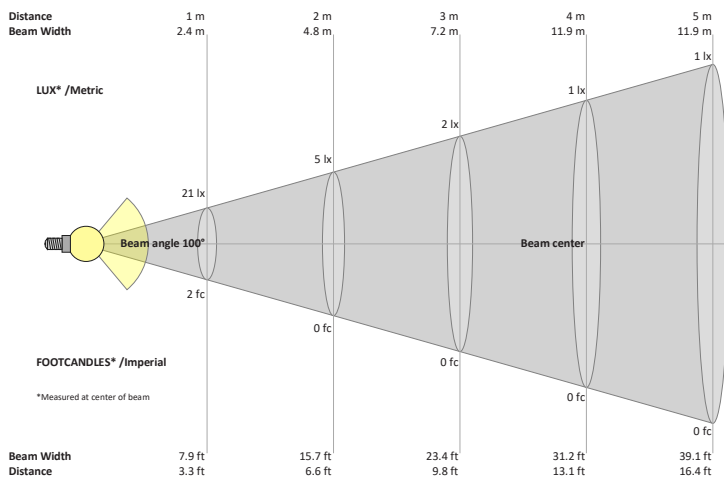

Beam Angle

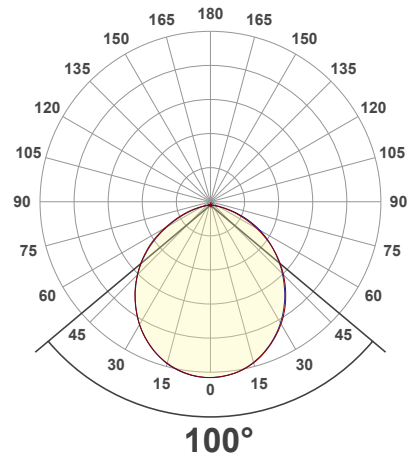

ORDERING GUIDE

Example part number: **VBD-TR4-RGBW-FG-S**

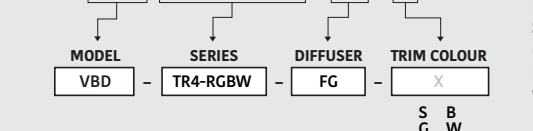

NOTES:

FG = Frosted Glass
S = Silver
G = Gold
B = Black
W = White



AVAILABLE TRIM MODELS

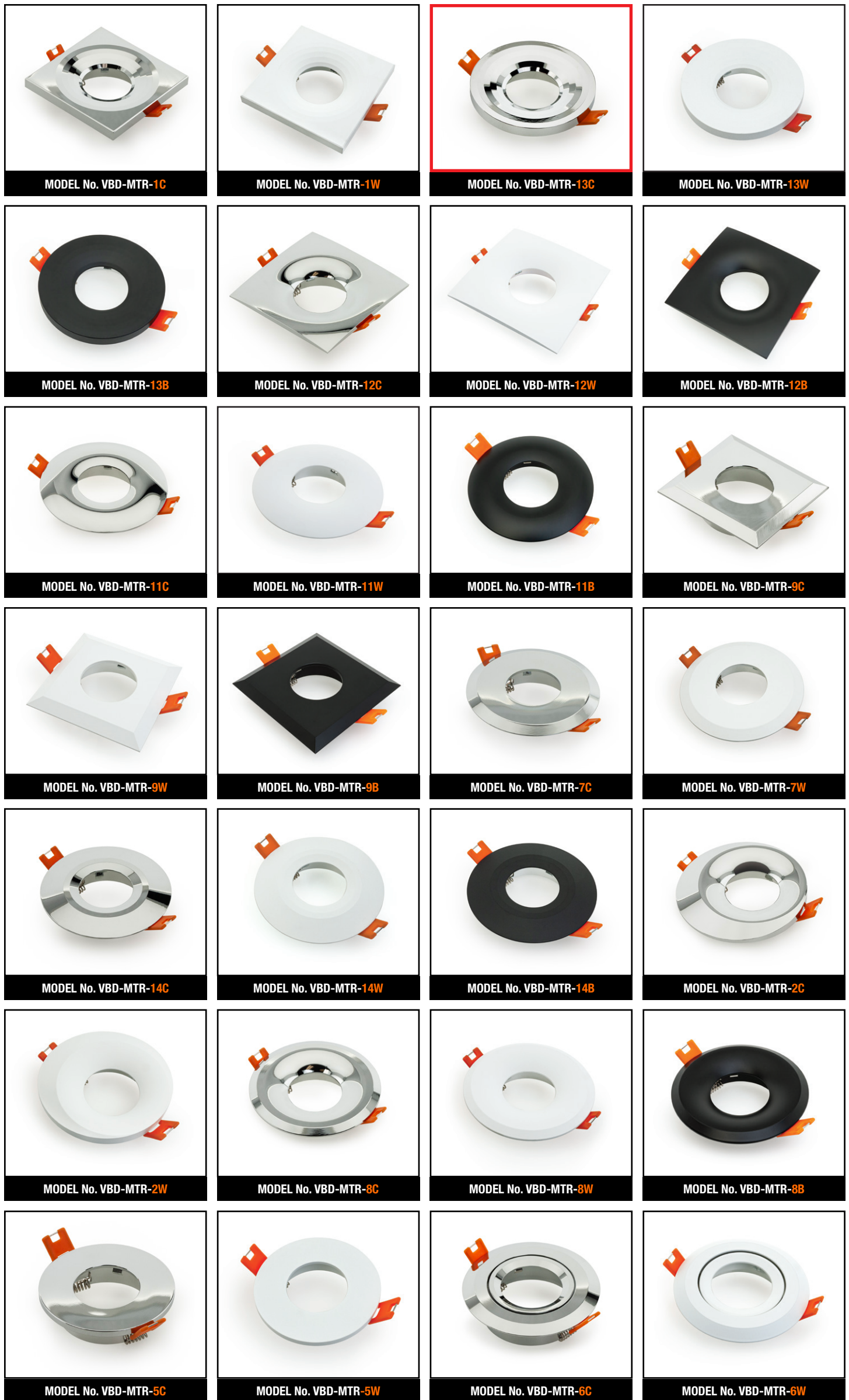

AVAILABLE TRIM MODELS



MODEL No. VBD-MTR-3C



MODEL No. VBD-MTR-3W



MODEL No. VBD-MTR-4C



MODEL No. VBD-MTR-4W



MODEL No. VBD-MTR-16C



MODEL No. VBD-MTR-16W



MODEL No. VBD-MTR-10W



MODEL No. VBD-MTR-10B



MODEL No. VBD-MTR-54T



MODEL No. VBD-MTR-59T



MODEL No. VBD-MTR-60T



MODEL No. VBD-MTR-65T



MODEL No. VBD-MTR-67T



MODEL No. VBD-MTR-70T



MODEL No. VBD-MTR-75T



MODEL No. VBD-MTR-76T



MODEL No. VBD-MTR-73T



MODEL No. VBD-MTR-74T



MODEL No. VBD-MTR-77T



MODEL No. VBD-MTR-78T



MODEL No. VBD-MTR-17-1W



MODEL No. VBD-MTR-17C



MODEL No. VBD-MTR-79W



MODEL No. VBD-MTR-80W



MODEL No. VBD-MTR-81W



MODEL No. VBD-MTR-82W



MODEL No. VBD-MTR-83W



MODEL No. VBD-MTR-84W

