







## SPECIAL FEATURE

-  3mm thickness high-definition eco-friendly glass mirror
-  This lighted make-up mirror uses built-in Energy Saving LED bulbs. Replacement bulbs are not required.
-  Free to switch between warm, natural and cool
-  Built-in touch sensor switch
-  Can be rotated 360 degrees
-  Power supplied by plug-in adapter



**READ ALL INSTRUCTIONS BEFORE USE. SAVE THESE INSTRUCTIONS FOR FUTURE REFERENCE. FOR HOUSEHOLD USE ONLY.**

### IMPORTANT SAFEGUARDS

**WHEN USING ELECTRICAL PRODUCTS, ESPECIALLY WHEN CHILDREN ARE PRESENT, BASIC SAFETY PRECAUTIONS SHOULD ALWAYS BE FOLLOWED, INCLUDING THE FOLLOWING**

- Close supervision is necessary when this furnishing is used by or near children or individuals with certain disabilities.
- NEVER insert pins or other metallic fasteners into the appliance.
- Use this appliance for the intended use as described in this booklet. DO NOT use attachments not recommended by ONE Home Collection.
- NEVER operate this appliance if it has a damaged cord or plug, if it is not working properly, if it has been dropped or damaged, or dropped into water.
- NEVER leave the mirror in a position where it can reflect sunlight; reflected sunlight can cause fire.
- Excessive use could lead to the products excessive heating and shorter life. Should this occur, discontinue use and allow the unit to cool before operating.
- NEVER drop or insert any object into any opening.
- DO NOT use on a soft surface, as a bed, where openings may be blocked.
- DO NOT use outdoors.
- DO NOT attempt to repair, disassemble or modify the appliance. There are no user serviceable parts.
- This product is not waterproof.
- DO NOT place or store appliance where it can fall or be pulled into a bath or sink.
- DO NOT place in or drop into water or other liquid.
- DO NOT reach for an appliance that has fallen in water or other liquids.
- Please avoid touching the mirror with sharp objects in order to prevent scratches that might affect the appliance usage.
- Turn off the appliance when not in use.
- Keep away from heated surfaces.
- This appliance is not a toy. Keep away from children

### SAFETY INSTRUCTIONS

**TO ENSURE PROPER OPERATION OF THIS MIRROR, PLEASE READ THIS INSTRUCTION MANUAL CAREFULLY BEFORE USING THE MIRROR AND KEEP IT FOR FURTHER REFERENCE.**

#### WARNING

- This mirror is not a toy, keep out of reach of children.
- Please check the mirror and stand before you start using it. Do not use if there is any damage.
- Make sure the mirror is not in a position where it can reflect sunlight.
- Reflected sunlight can cause a fire.
- DO NOT place the mirror where it can easily fall.
- DO NOT attempt to disassemble, repair, or modify the mirror by yourself to avoid accidents.

#### CAUTION

- Avoid touching the mirror with sharp objects to prevent scratches.
- Keep the mirror dry. Humidity may affect and reduce the sensitivity of the mirror's touch switch.
- Use and store the mirror in places out of reach of children.
- This appliance is only to be used with the power supply unit provided with appliance.



©2021  
20218 Hamilton Avenue  
Torrance, CA 90502, USA

Made in China

# LED BEAUTY MIRROR

OPERATION MANUAL

OPCM001

ONE  
HOME COLLECTION

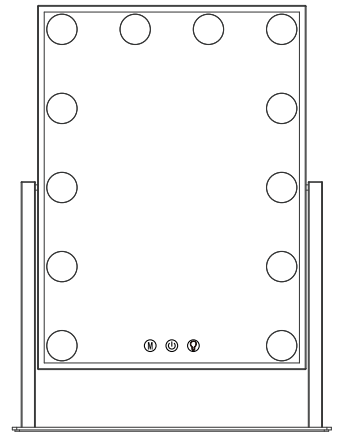

## PACKING LIST



Desktop LED Vanity Mirror





Power Adapter



Instruction Manual

## OPERATING INSTRUCTIONS

- (1) Please use original adapter DC12V/1A, connect the appropriate adapter to the charger port on the back.
- (2) Press  switch to turn the light on/off. 100% brightness when turned on.
- (3) Press  to switch between warm, natural and cool light
- (4) Press down and hold  to adjust the brightness
- (5) Unplug the adapter when it is not in use.

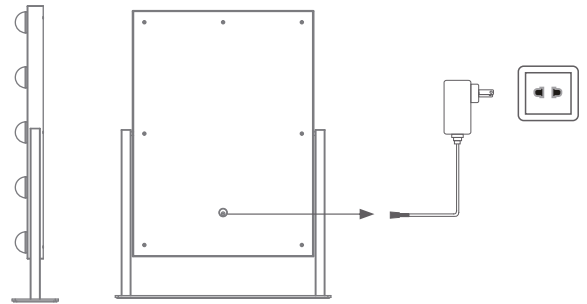
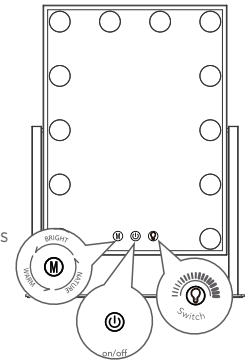

## ILLUSTRATE

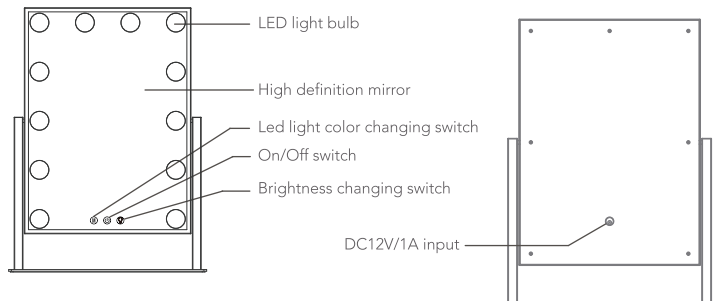

## SPECIFICATIONS

- [Product Name] Desktop Led Vanity Mirror
- [Material] Metal+Glass
- [LED Color Temperature] 6500K/3500K±500K
- [LED LM] 24-26LM
- [Power Supply] 12V/1A
- [Net Weight] 2680g±20g
- [Product Size] 36.5\*47.5\*7.5cm
- [Package Size] 54\*44\*15cm

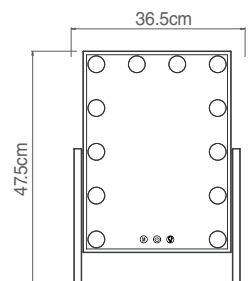

**We** or us means ONE Home Collection our contact details are set out at the end of this warranty;

**You** means the purchaser or the original end-user of the Goods. You may be a domestic user or a professional user.

**Supplier** means the authorised distributor or retailer of the Goods that sold you the Goods; and

**Goods** means the product or equipment which was accompanied by this warranty and purchased in the United States.

### **The Warranty**

ONE Home Collection sells its products with the intent that they are free of defects in manufacture and workmanship under normal use and service. In the unlikely event that your product proves to be faulty within 1 year from the date of purchase due to workmanship or materials only, we will replace it at our own expense, subject to the terms and conditions of this guarantee. The warranty period is limited to 3 months from the date of purchase for products used commercially/professionally.

### **Terms and Conditions:**

In addition to the rights and remedies that you have or any other applicable law and without excluding such rights and remedies warranty against defects:

1. The Goods are designed to withstand the rigors of normal household use and are manufactured to the highest standards using the highest quality components. Whilst unlikely, if, during the first 12 months (3 months commercial use) from their date of purchase from the Supplier (Warranty Period), the Goods prove defective by reason of improper workmanship or materials and none of your statutory rights or remedies apply, we will replace the Goods, subject to the terms and conditions of this warranty.
2. We do not have to replace the Goods under this Additional Warranty if the Goods have been damaged due to misuse or abuse, accident, the attachment of any unauthorised accessory, alteration to the product, improper installation, unauthorised repairs or modifications, improper use of electrical/power supply, loss of power, malfunction or damage of an operating part from failure to provide manufactures recommended maintenance, transportation damage, theft, neglect, vandalism, environmental conditions or any other conditions whatsoever that are beyond the control of ONE Home Collection.
3. This Warranty does not extend to the purchase of used, repaired or second-hand products or to products not imported or supplied by ONE Home Collection, including but not limited to those sold on offshore internet auction sites.
4. This Warranty extends only to consumers and does not extend to Suppliers
5. Even when we do not have to replace the Goods, we may decide to do so anyway. In some cases, we may decide to substitute the Goods with a similar alternative product of our choosing. All such decisions are at our absolute discretion.
6. This Additional Warranty does not cover items damaged by normal wear and tear including but not limited to chips, scratches, abrasions, discolouration and other minor defects, where the damage has negligible effect on the operation or performance of the Goods.
7. This Additional warranty is limited to replacement or substitution only. As far as the law permits, we will not be liable for any loss or damage caused to property or persons arising from any cause whatsoever and shall have no liability for any incidental, consequential or special damages.
8. This warranty is only valid and enforceable in the United States.

### **Making a Claim:**

In order to claim under this Warranty you must return the Goods to the Supplier (place of purchase) for replacement. If this is not possible, please contact our customer service department at the address below.

- All returned Goods must be accompanied by satisfactory proof of purchase which clearly indicates the name and address of the Supplier, the date and place of purchase and identifies product. It is best to provide an original, legible and unmodified receipt or sales invoice
- You must bear any expense for return of the Goods or otherwise associated with making your claim under this Additional Warranty.