

MARSH-McBIRNEY, INC.

FLO-MATE™

MODEL 2000 PORTABLE FLOWMETER
INSTRUCTION MANUAL

MODEL 2000
INSTALLATION AND OPERATIONS
MANUAL

DECEMBER 1990

Marsh-McBirney Inc.
4539 Metropolitan Court
Frederick, Maryland 21704-9452

(301) 874-5599 • (800) 368-2723 • FAX (301) 874-2172 • www.marsh-mcBirney.com

CONTENTS

General Description	1
Theory of Operation	2
Design Features	3
Operation	4
Real-Time Operating Mode	4
Display ON Sequence	4
Units of Measurement/Beeper	5
Fixed Point Average/Time Constant Filtering	5
FPA	5
rC	6
FPA/rC Time	6
Clearing the Display	7
Storing Velocity Readings	7
Recall Operating Mode	8
Zero Adjust	8
Zero Check	8
Zero Adjust	9
Errors	10
Error Messages	10
Error Codes	11
Key Function Summary	11
One-Key Functions	11
Two-Key Functions	11
Maintenance	12
Cleaning the Sensor	12
Changing Batteries	12
Battery Life	13
Battery Change Guide	13
Self Discharge in Storage	13
Low Battery Flag	13
Options	14
Sensor Disconnect	14
Power-In-Signal-Out Connector	14
Carrying Case	15

Sensors	15
Open-Channel-Velocity Sensor	15
Full-Pipe-Velocity Sensor	16
Sensor Mounting Configurations	16
Universal-Sensor Mount	16
Standard Wading Rod	17
Double-End Hanger	17
Top-Setting-Wading Rod	18
Suspension Cable	20

SPECIFICATIONS

Velocity Measurement

Method
Electromagnetic

Zero Stability
± 0.05 ft/sec

Accuracy
± 2% of reading + zero stability

Range
-0.5 to +19.99 ft/sec
-0.15 m/sec to +6 m/sec

Power Requirements

Batteries
Two D Cells

Battery Life Continuous ON hours
Alkaline 25-30
NiCad 10-15 per charge

External Power Supply (Optional)
120 V, 1 W or 220 V, 1 W

Water Resistant Electronic Case

Submersible
One Foot for 30 Seconds

Outputs

Display
3¹/₂ Digit

Signal Output Connector (Optional)
Analog 0.1 V = 1 ft/sec or 1 m/sec
2 V = Full Scale

Materials

Sensor
Polyurethane

Cable
Polyurethane jacket

Electronic Case
High Impact Molded Plastic

Weight

3 lb 9 oz with case and 20 ft of cable
2 lb 10 oz without sensor and cable

Temperature

Open-Channel-Velocity Sensor
32° F to 160° F (0° C to 72° C)

Full-Pipe Sensor (S/S Insertion Tube)
32° F to 160° F (0° C to 72° C) @ 250 psi

Electronics
32° F to 122° F (0° C to 50° C)

GENERAL DESCRIPTION

The Marsh-McBirney Model 2000 Flo-Mate is a portable flowmeter designed for use in both the field and the laboratory. The unit uses an electromagnetic sensor to measure the velocity in a conductive liquid such as water. The velocity is in one direction and displayed on a digital display as feet per second (ft/s) or meters per second (m/s).

A watertight case protects the electronics from wet weather and accidental submersions. The unit is powered by two D-size batteries in the bottom of the case. A shoulder strap and 20 feet of sensor cable are standard. Excess sensor cable is coiled and secured to the shoulder strap by the sensor cable retainer.

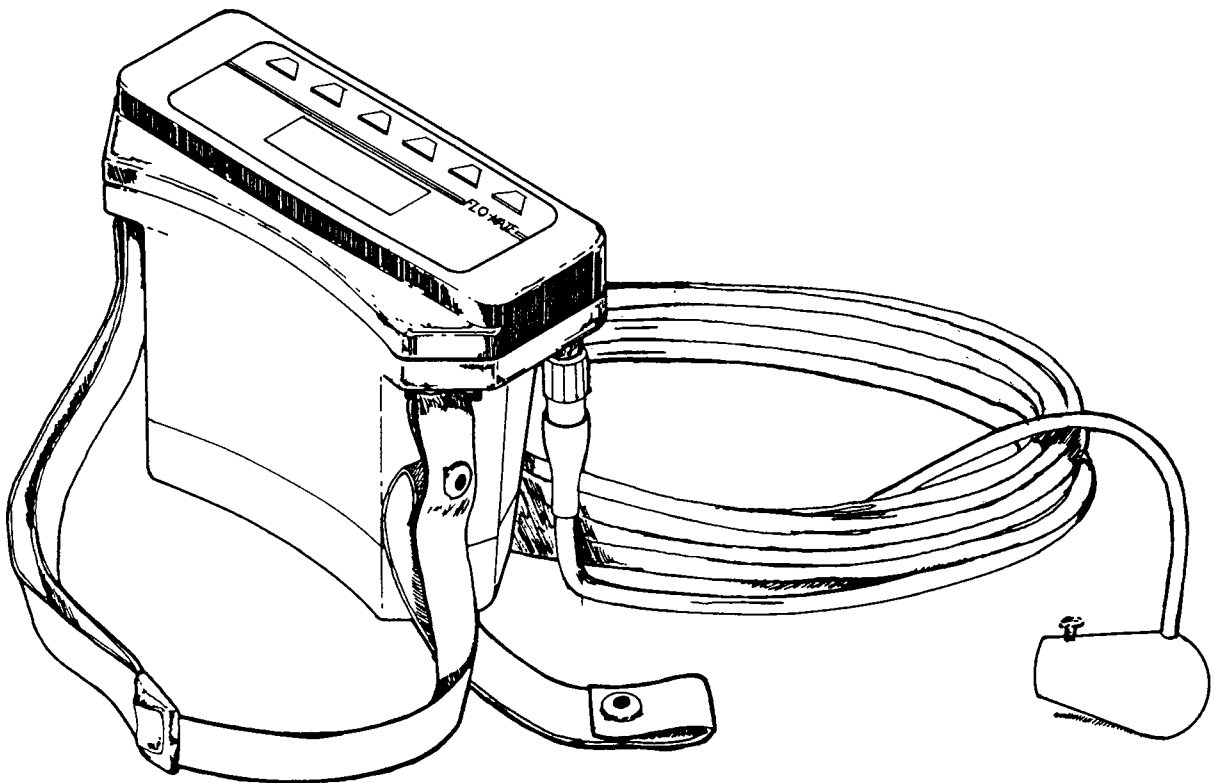

Figure 1. Model 2000 Flo-Mate

THEORY OF OPERATION

The Flo-Mate measures flow using the Faraday law of electromagnetic induction. This law states that as a conductor moves through a magnetic field, a voltage is produced. The magnitude of this voltage is directly proportional to the velocity at which the conductor moves through the magnetic field.

When the flow approaches the sensor from directly in front, then the direction of the flow, the magnetic field, and the sensed voltage are mutually perpendicular to each other. Hence, the voltage output will represent the velocity of the flow at the electrodes.

The sensor is equipped with an electromagnetic coil that produces the magnetic field. A pair of carbon electrodes measure the voltage produced by the velocity of the conductor, which in this case is the flowing liquid. The measured voltage is processed by the electronics and output as a linear measurement of velocity.

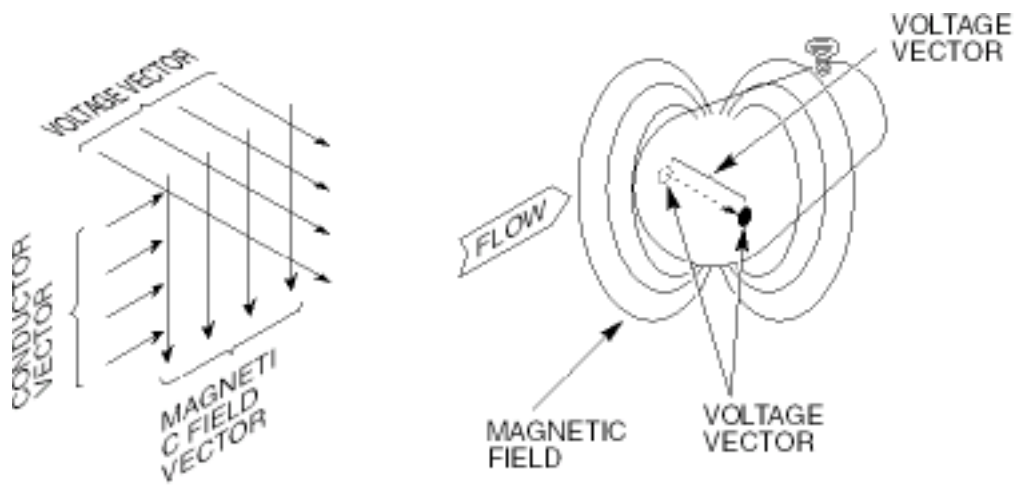

Figure 2. Theory of Operation

DESIGN FEATURES

The Model 2000 design features are as follows:

- Lightweight (3 lb 9 oz with sensor and 20 ft of cable), water resistant, and rugged. The case is made of a high impact molded material which protects the electronics from wet environments and accidental submersions.
- Digital filtering. The sensor electronics uses digital filtering. This does a better job than analog filtering in rejecting electrical noise that may be present in the flow.
- Noise flag. If there is enough electrical noise present in the flow to interfere with normal operation, the display will blank out and the noise flag is displayed.
- Conductivity lost detection. A conductivity lost flag is displayed and the velocity readings are blanked out when conductivity lost is detected. Conductivity lost is usually caused by the sensor being out of the water.
- Dry sensor power down. The unit stops driving the sensor five seconds after conductivity lost is detected. This results in a 66% reduction in power consumption, which conserves battery life. If the sensor is dry for more than 5 minutes, the unit will turn itself OFF.
- Automatic shut off. After five minutes of conductivity lost, the unit will shut itself off thus conserving battery life.
- Low battery flag. A low battery flag is displayed when the battery voltage drops below a certain value. The amount of time the batteries will last after the flag is displayed can vary from an hour (alkaline) to 15 minutes (nicads). The unit will shut itself off if the voltage drops too low.
- Clear display function. The clear display function clears the display and restarts the filtering.
- Data storage and recall ability. There are 19 memory locations in which to store and recall velocity measurements.
- Unit of measurement selection. The meter can be switched between English (ft/s) and metric (m/s) units of measurement.
- Selectable filtering modes for display output. Fluid dynamics near the sensor electrodes may cause slightly noisy readings. The output can be stabilized by averaging the velocities over a fixed time period or by a software algorithm that mimics an RC time constant.

OPERATION

The Model 2000 has two operating modes: Real-Time and Recall. In the Real-Time operating mode, Real-Time velocities from the sensor are displayed. In the Recall operating mode, velocities from memory are displayed.

Comment

In the Recall mode, the time bar will be stationary.

Real-Time Operating Mode

The unit will always power up in the real-time operating mode. From the real-time mode you can change the filter value, store readings in memory, turn the beeper on or off, alternate between feet per second (ft/s) and meters per second (m/s), alternate between fixed point averaging and time constant filtering, and switch to the recall operating mode.

Display ON Sequence

When the unit is turned ON, the display output sequence is as follows:

- Software version number. This is the Model 2000 operating software that was burned into the electronics at the factory.
- Display segment test. The unit will light all display segments.
- Velocity output. The first few readings are not filtered; however, they are accurate.

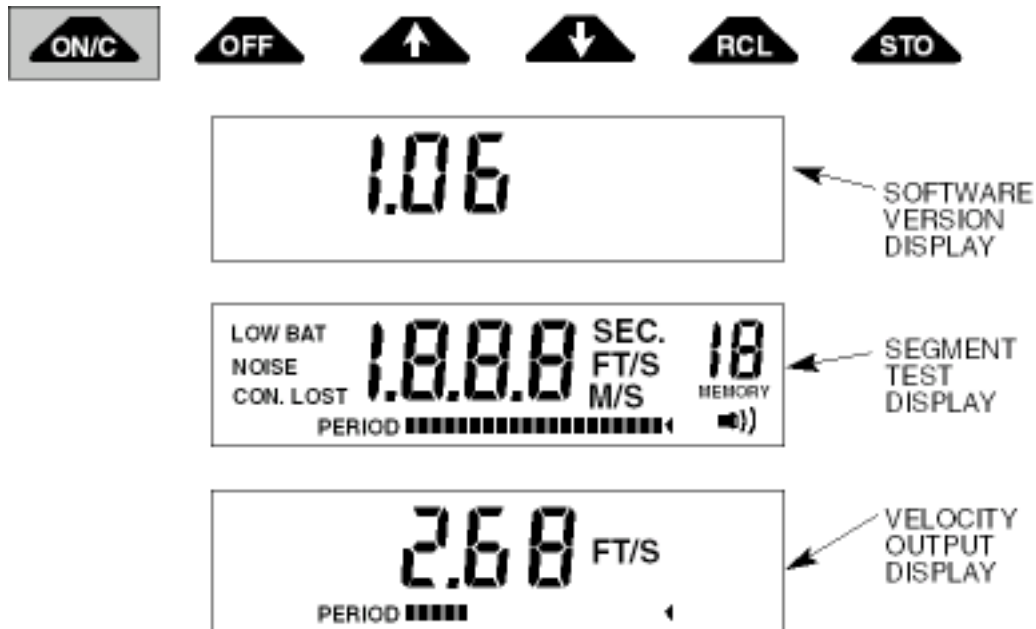

Units of Measurement/Beeper

The Model 2000 can output velocity in ft/s or m/s. When the beeper symbol is shown, the beeper is active. Press down on the ON/C and OFF keys simultaneously to cycle between:

- FT/S no beeper
- M/S no beeper
- F/S with beeper
- M/S with beeper



Fixed Point Average/Time Constant Filtering

The fluid dynamics around the sensor electrodes may cause the readings to bounce around. To stabilize the readings, the output to the display is dampened. The display can be dampened by Fixed Point Averaging (FPA) or by time constant filtering (rC).

Fixed Point Averaging is an average of velocities over a fixed period of time. Time constant filtering is a software algorithm that mimics an RC analog circuit. Press the ↑ and ↓ keys simultaneously to alternate between the FPA and rC displays.

FPA

The display will show the letters FPA when you first switch to the FPA display. Except for the first period, the display is updated at the end of each averaging period. For example, if the FPA is set to 10 seconds, the display is updated once every ten seconds. The FPA display will have a horizontal time bar under the velocity output. The time bar provides an indication as to the amount of time left until the display is updated.

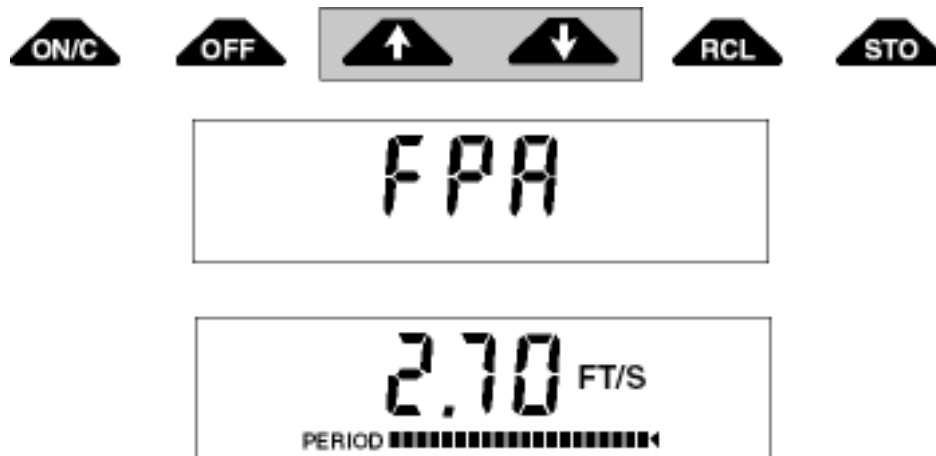

rC

The display will show the letters rC when you first switch to the time constant mode. The display will start with unfiltered full scale velocities. These readings are accurate but may bounce around slightly. As the filtering takes effect, the readings will settle out. It takes five time constants to get to maximum filtering. There is no time bar on the rC display because the display is continually updated.

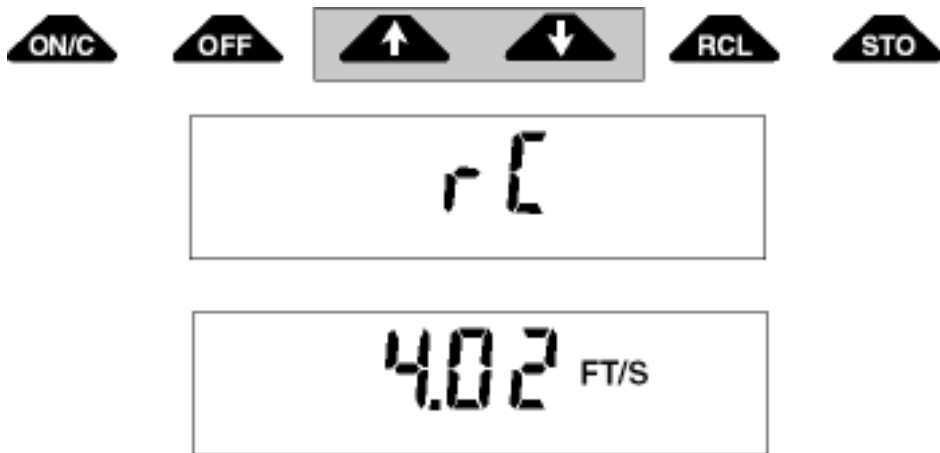

FPA/rC Time

The FPA and rC time is specified in seconds. The ↑ key increments time and the ↓ key decrements time. The display will show the FPA/rC length in seconds. After you have reached the desired setting, wait and the display will automatically switch to velocity.

Comment:

Limits are 2-120 seconds for FPA and 2-30 seconds for rC. Changing FPA and rC time restarts the filtering.

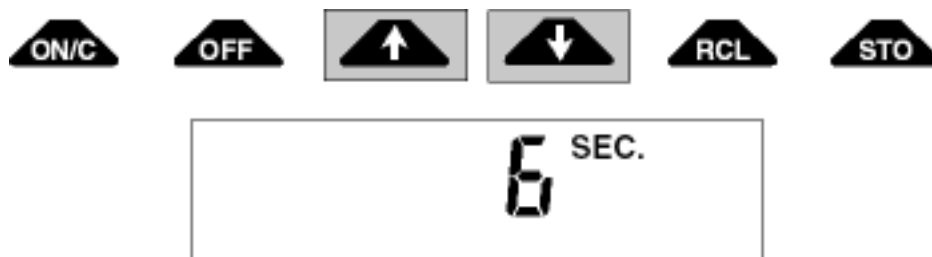

Clearing the Display

The clear function will clear the display and restart the filtering. To clear the display, press the ON/C key. The display will blank out for a second and then restart to output velocity readings.

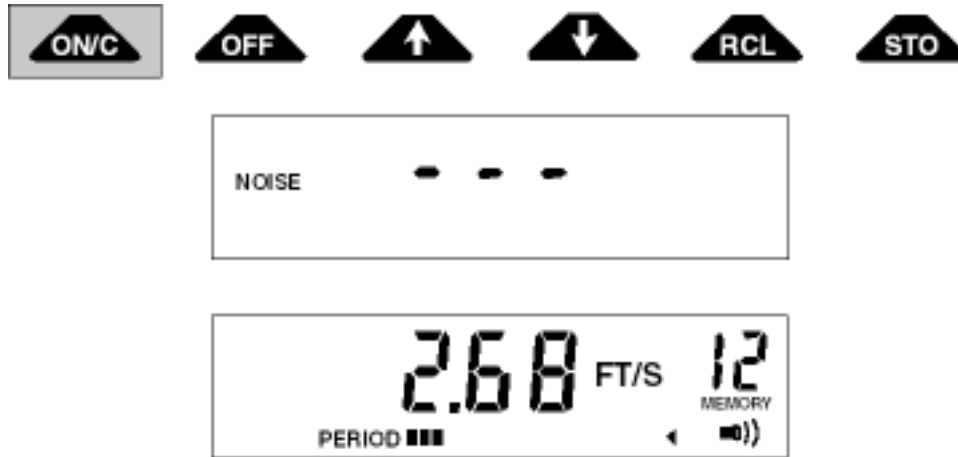

Storing Velocity Readings

There are 19 memory locations in which velocity readings can be stored. To store a reading, press the STO key when the desired velocity is displayed. The unit will store the reading and automatically increment to the next empty location. The memory location shown on the display is where the present reading will be stored. No memory locations are shown until after the first reading has been stored.

Comment:

Except for the beeper symbol, the STO function will store the display as you see it. Turning the unit off or changing batteries will not affect the memory.

If you want to measure a prior location again, you need to switch to the recall mode with the RCL key. Go back to the prior location with the ↑ key. Switch to the real-time mode with the RCL key and when you get a good velocity reading store it with the STO key. The reading is stored, and the unit advances to the next empty memory location.

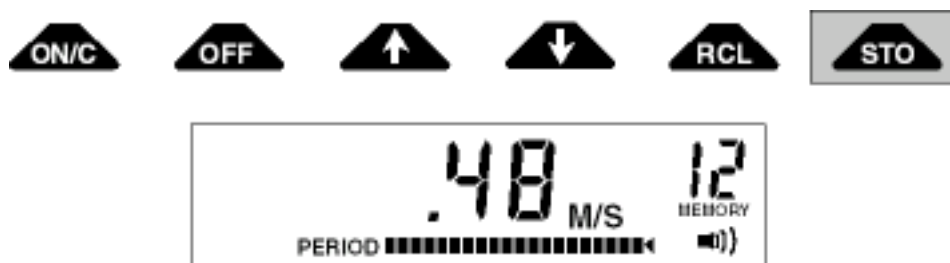

Recall Operating Mode

The recall operating mode outputs the velocity readings that have been stored in memory. The recall mode is indicated by a blinking memory location number and always starts at location one. To switch to the recall mode, press the RCL key. The memory location and the velocity stored in that location is shown on the display. Increment and decrement through the locations with the ↑ and ↓ keys respectively. With the exception of the first empty location, only the locations that have stored readings can be recalled.

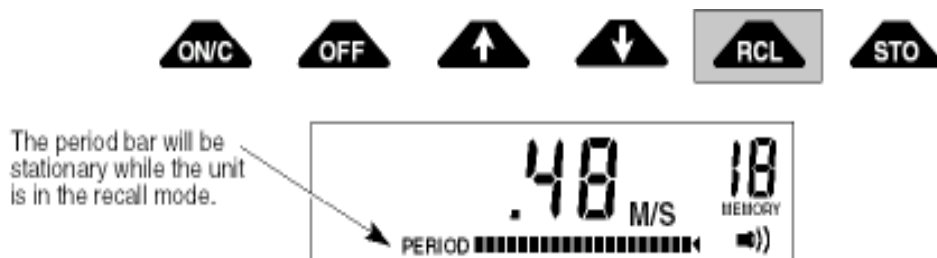

To clear memory, press the ON/C and STO keys simultaneously. Memory can be cleared from both the Recall and Real-Time operating modes.

ZERO ADJUST



Zero Check

First clean the sensor (Page 12) because a thin film of oil on the electrodes can cause noisy readings. Then place the sensor in a five gallon plastic bucket of water. Keep it at least three inches away from the sides and bottom of the bucket. To make sure the water is not moving, wait 10 or 15 minutes after you have positioned the sensor before taking any zero readings. Use a filter value of 5 seconds. Zero stability is ± 0.05 ft/sec.

Zero Adjust

- Position the sensor as described in the zero check procedure.
- To initiate the zero start sequence, press the STO and RCL keys at the same time. You will see the number 3 on the display.
- Decrement to zero with the ↓ key.



- The number 32 will be displayed.
- The unit will decrement itself to zero and turn off. The unit is now zeroed.

Comment:

Each key in the zero adjust sequence must be pressed within 5 seconds of the previous key. If the time between key entries is longer than 5 seconds or if a wrong key is pressed, the unit will display an ERR 3. Turn the unit OFF then back ON and try again.

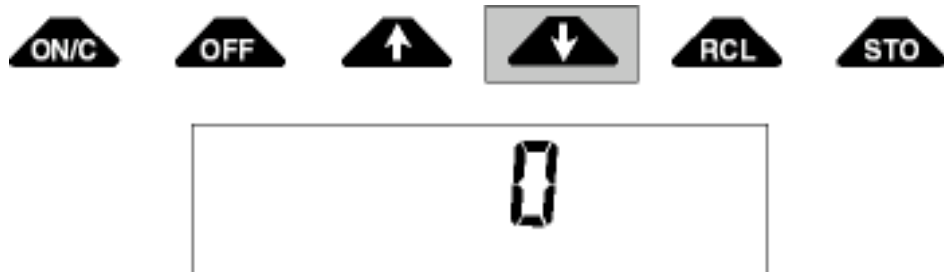

ERRORS

The purpose of displaying errors is to alert the user of possible problems with either the unit or application. Errors can be displayed as messages or numerical codes. There are three error messages and five numerical codes.

Comment:

With the exception of Err 2, error codes freeze the display. Turn the unit OFF then back ON to clear the display. If after corrective action the error still exists, call the factory.

Error Messages

Low Bat Indicates low batteries (Page 13).
Replace the batteries (Page 12).



Noise Indicates excessive electrical noise is present in the flow which will interfere with normal operation. This will cause the display to blank out.



Comment:

The noise flag usually comes on for few a seconds after the sensor is submerged even though there is no noise present. This is normal.

Con Lost Indicates that either the sensor electrodes are out of the water or they have become coated with oil or grease. After 5 minutes, the unit will turn itself OFF. If the electrodes are coated, clean them (Page 12).

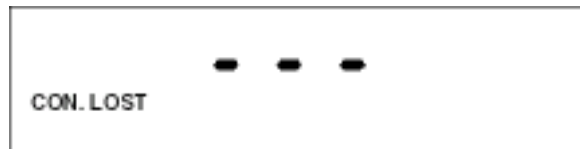

Error Codes

Error #1 Problem with sensor drive circuit.
Check sensor disconnect.

Error #2 Memory full error. Memory must be
cleared before another reading can
be stored.

Error #3 Incorrect zero-adjust-start sequence. Reinitiate zero-adjust-start sequence.

Error #4 Zero offset is greater than the zero adjust range. Repeat the zero-adjust procedure. If the
error is still displayed, the unit needs servicing.

Error #5 Conductivity lost or noise detected during zero adjust. Usually caused by the sensor
being out of the water.

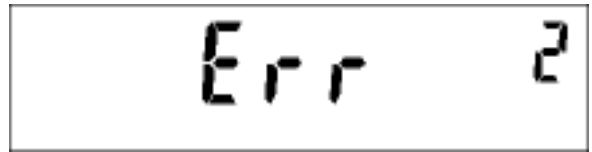

KEY FUNCTION SUMMARY

One-Key Functions



- Turns Unit ON. Clears the display and restarts the meter.



- Turns Unit OFF.



- Increments FPA, TC, and Memory Location.



- Decrements FPA, TC, and Memory Location.



- Alternates Between Recall and Real-Time Operating Modes.



- Stores Values In Memory.

Two-Key Functions



- Change Units, Turns Beeper ON/OFF.



- Alternates Between FPA and rC Filtering.



- Clears Memory.



- Initiates zero adjust sequence. Zero stability is ± 0.05 ft/sec.

MAINTENANCE

Routine maintenance of the unit is confined to cleaning the sensor and changing the batteries.

Cleaning the Sensor

Nonconductive coatings (oil and grease) can cause noisy readings or conductivity lost errors. Clean the sensor with soap and water. If a problem still persists, clean the electrodes with a very fine grit (600) sandpaper. Do not use hydrocarbon solvents.

Changing Batteries

A low battery flag is displayed when a low battery voltage is detected. Check the battery change guide (Page 13) for battery-life estimates.

The battery compartment (Figure 3) is located in the bottom of the meter. To change the batteries, unscrew the three captive screws on the bottom cover. Remove cover and replace the batteries (two D size). Reinstall the bottom cover.

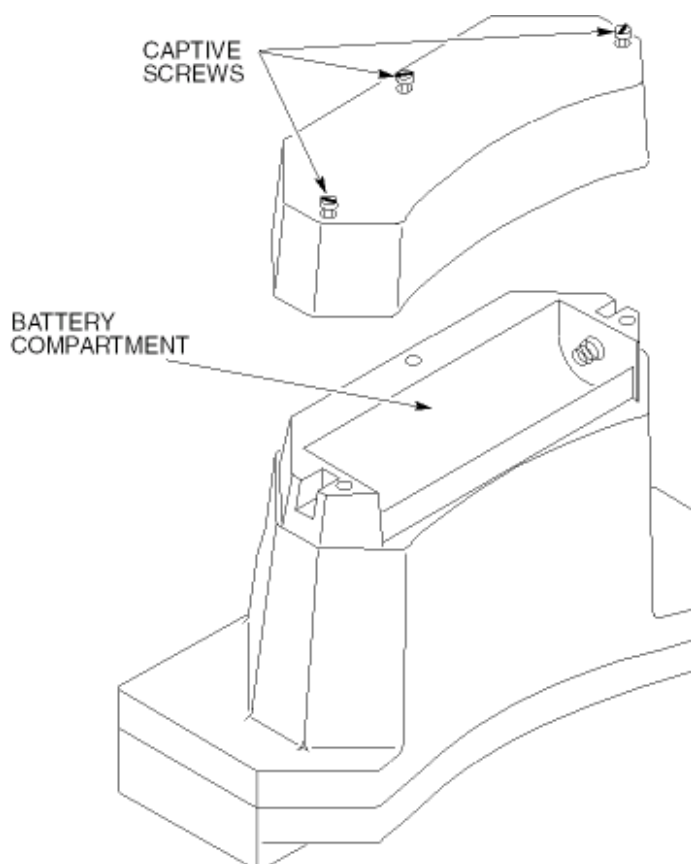

Figure 3. Battery Compartment

BATTERY LIFE

The battery life will vary from unit to unit because of different battery types, different ambient temperatures and different applications. The battery change guide below will help you to determine when to change the batteries until you gain experience in using your flowmeter in your application.

Battery Change Guide

The hours shown in the battery life table are estimates based upon a continuous ON at an ambient temperature of 72° F (22° C).

Battery Life Table

BATTERY TYPE	HOURS OF CONTINUOUS ON
Alkaline	25 - 30
Carbon Zinc	5 (Not Recommended)
NiCad*	10 - 15 (Per Charge)

* Sanyo KR4400-D

Typically the flowmeter is not continuously on and the ambient temperature varies from application to application. The effect this will have on battery life is as follows.

- Alkaline-battery life will be increased by as much as 30% when cycled on and off.
- At 32° F (0° C) alkaline-battery life will be reduced by 20%.
- At 110° F (40° C) alkaline-battery life is increased by 10%.

Comment:

The power-in-signal-out option is required for charging the NiCad batteries in the battery compartment. See Caution on Page 14 before using NiCad batteries.

Self Discharge in Storage

Alkaline batteries will lose approximately 5% to 10% of their charge per year. NiCad batteries will lose about 1% to 2% of their charge per day. Therefore, NiCad batteries should be charged shortly before use.

Low Battery Flag

A low battery flag is displayed when the battery voltage drops below a certain value. The amount of time the batteries will last after the flag is displayed can vary from an hour (alkaline) to 15 minutes (NiCad batteries). The unit will shut itself off if the voltage drops too low.

OPTIONS

Sensor Disconnect

The sensor cable can be disconnected from the flowmeter with the sensor disconnect option. To disconnect the sensor, pull the latch release (Figure 4) toward the sensor cable.

To connect the cable, align the latch alignment marks and push the connector together.

Comment:

If you change sensors, check the zero (Page 9).

Power-In-Signal-Out Connector

Except for being smaller in size, the power-in-signal-out connector (Figure 4) operates the same as the sensor disconnect. The connection to the output signal is made on a terminal strip that is attached to the AC power adapter.

The signal can be output to external recording devices.

Output impedance = 1.1 K Ω

Output signal is 0.1 V = 1 ft/sec or 0.1 V = 1 m/sec.

Maximum scale is 2 volts.

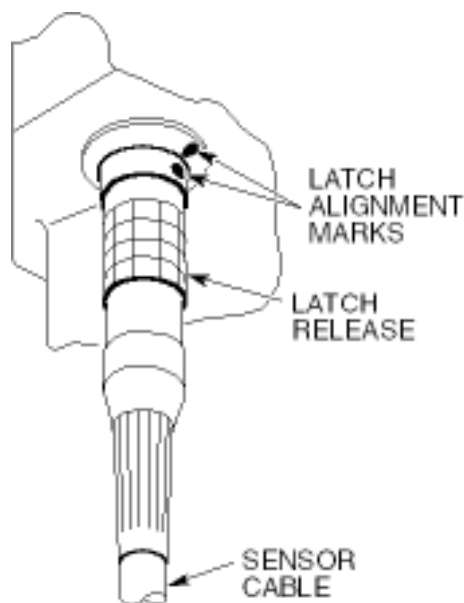

Figure 4. Sensor disconnect

[CAUTION]

Only use the NiCad batteries that are supplied with the AC power option. If batteries other than 4.4 Ah nicads are used, they may rupture and damage the unit or present a hazard to the operator.

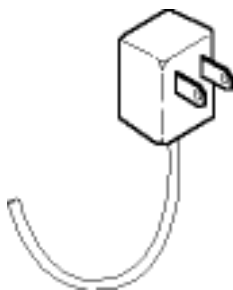

Figure 5. AC Power Adapter

The flowmeter is shipped with 2 D-Size Sanyo KR4000-D NiCad batteries installed that should be left in the unit when external power is being used. They serve as a filter and provide backup power if the main power fails. A well isolated AC power adapter (Figure 5) serves as a battery charger and external power source. The NiCads take about 14 hours to charge. Power requirements are 300 mA, 3 V for wet sensor; 100 mA, 3 V for dry sensor.

Carrying Case

The carrying case for the Model 2000 (Figure 6) is a padded nylon case with two compartments and a shoulder strap. The back compartment is for the meter, and the front compartment is for the sensor and cable. The sensor compartment is made of nylon mesh which lets air circulate through the sensor compartment.

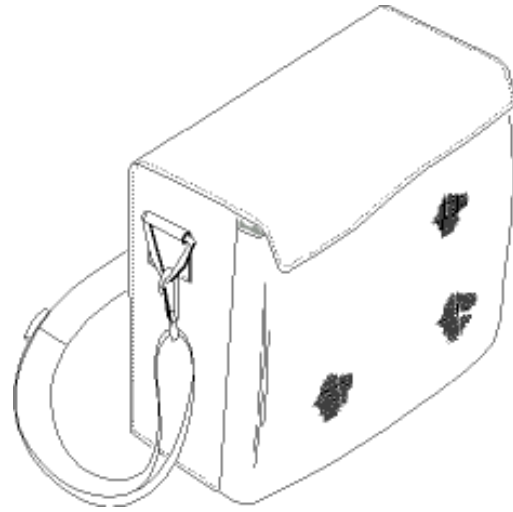

Figure 6. Carrying Case

SENSORS

The Model 2000 can be configured with an open-channel-velocity sensor, a one-inch full-pipe-velocity sensor, or a two-inch full-pipe-velocity sensor. The open-channel-velocity sensor is the standard configuration.

Open-Channel-Velocity Sensor

The front of the open-channel-velocity sensor is round with three electrodes. A mounting hole is in back, and a thumbscrew is on top (Figure 7). The front of the sensor must be pointed upstream and the electrodes must be in contact with the flow to get good readings.

Comment:

The electrodes on all sensors must be kept free from nonconductive coatings such oil and grease.

The open-channel-velocity sensor shape produces a cosine response which greatly reduces errors due to sensor positioning. For example, if the front of the sensor is pointed away from the flow at a 10° angle, the cosine of 10° is 0.98480. This is only 1.5% lower than the actual velocity.

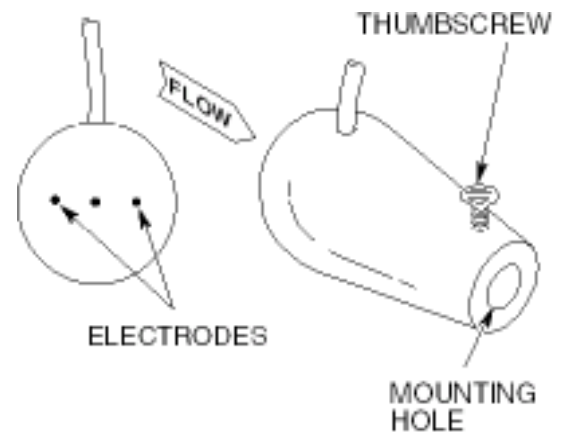
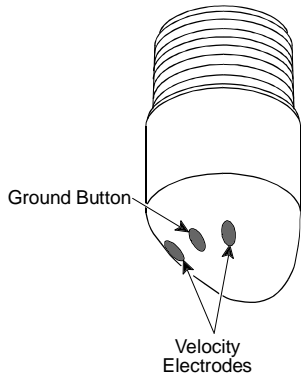

Figure 7. Open-Channel-Velocity Sensor



Full-Pipe-Velocity Sensor

The Model 2000 can be configured with either a one-inch full-pipe-velocity sensor or a two-inch full-pipe-velocity sensor (Figure 8). The installation instructions for the full-pipe sensors are contained in the manuals titled “One-Inch Full-Pipe Sensor Installation” and “Two-Inch Full-Pipe Sensor Installation. The sensor disconnect is required when the unit is configured with a full-pipe sensor.

Figure 8. Full-Pipe Velocity Sensor

SENSOR MOUNTING CONFIGURATIONS

Universal-Sensor Mount

The sensor can be attached to different size poles with the universal-sensor mount (Figure 9).

Mounting instructions are as follows:

- Insert the mounting shaft on the universal mount into the hole at the back of the sensor. The thumbscrew needs to be seated in the groove, so make sure the shaft is completely inserted into the hole.
- Hand tighten the thumbscrew.
- Slide a pole one inch or less in diameter through the clamp and tighten.

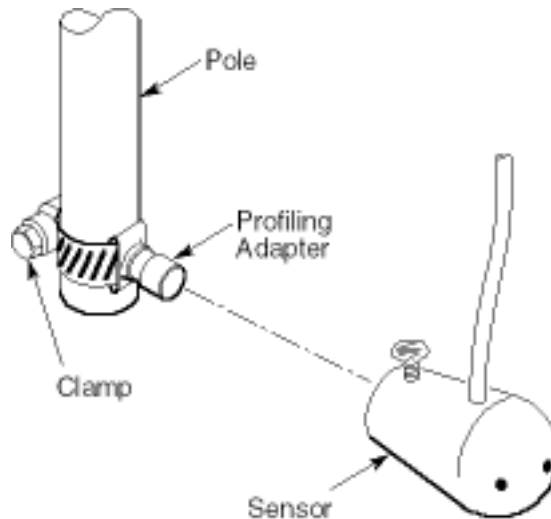

Figure 9. Universal Sensor Mount

[CAUTION]

Do not over tighten the thumbscrew on the sensor. Excessive force on the thumbscrew could damage the sensor.

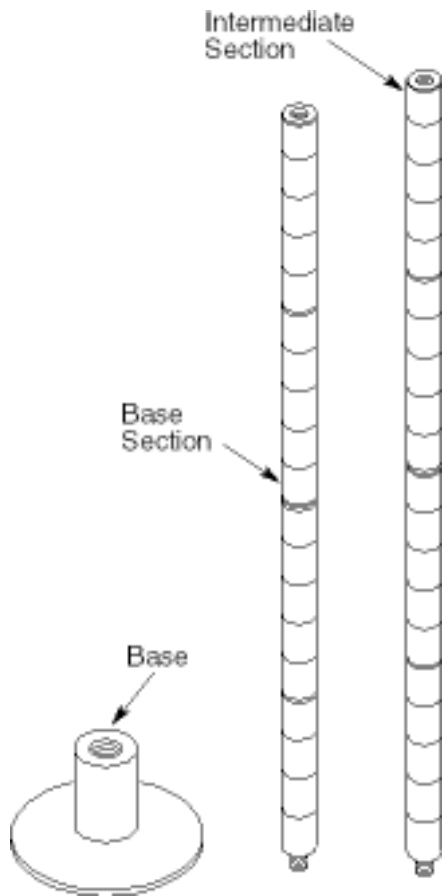

Figure 10. Standard Wading Rod

Standard Wading Rod

Both the metric and English standard wading rods have a base, a bottom section, a double end hanger, and three intermediate sections (Figure 10). Each intermediate section is two feet in length (English), or one half meter in length (metric). The bottom section is shorter; but when it is screwed to the base, the overall length is equal to the intermediate sections. Each section is divided into 0.10 foot (single marks), 0.50 foot (double marks) and 1.0 foot (triple marks) increments (English), or 5 cm (single marks) and 10 cm (double marks) increments (metric).

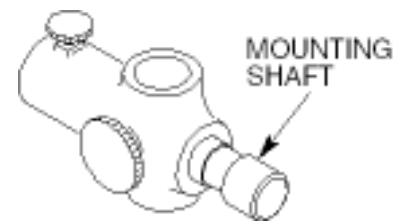

Figure 11. Double-End Hanger

Hanger

Double-

End

The sensor is mounted to the standard wading rod with a double-end hanger (Figure 11). Slide the wading rod through the hole in the hanger and hand tighten the locking screw on the side. Insert the mounting shaft on the hanger into the hole in back of the sensor. Then hand tighten the thumbscrew on top of the sensor. The thumbscrew must be seated in the groove on the shaft so make sure the mounting shaft is completely inserted into the hole on the sensor.

Top-Setting-Wading Rod

Two accepted methods for determining mean velocities of flows are as follows:

1. Measure the velocity at 60% of the depth (from the top) and use this as the mean.
2. Measure the velocity at 20% and 80% of the depth (from the top). Use the average of these velocities as the mean.

The purpose of the top setting wading rod (Figure 12) is to conveniently set the sensor at 20%, 60%, or 80% of total depth. The total depth can be measured with the depth gauge rod. Each single mark represents 0.10 foot, each double mark represents 0.50 foot, and each triple mark represents 1.00 foot.

To set the sensor at 60% of the depth, line up the foot scale on the sliding rod with the tenth scale on the top of the depth gauge rod. If, for example, the total depth is 2.7 feet, then line up the 2 on the foot scale with the 7 on the tenth scale.

To set the sensor at 20% of the depth, multiply the total depth by two and repeat the above procedure. In the above example this would be 5.4 feet. Line up the 5 on the foot scale with 4 on the tenth scale.

To set the sensor at 80% of the depth, divide the total depth by two and repeat the above procedure. In the above example, this would be 1.35 feet. Line the 1 on the foot scale with 0.35 on the tenth scale.

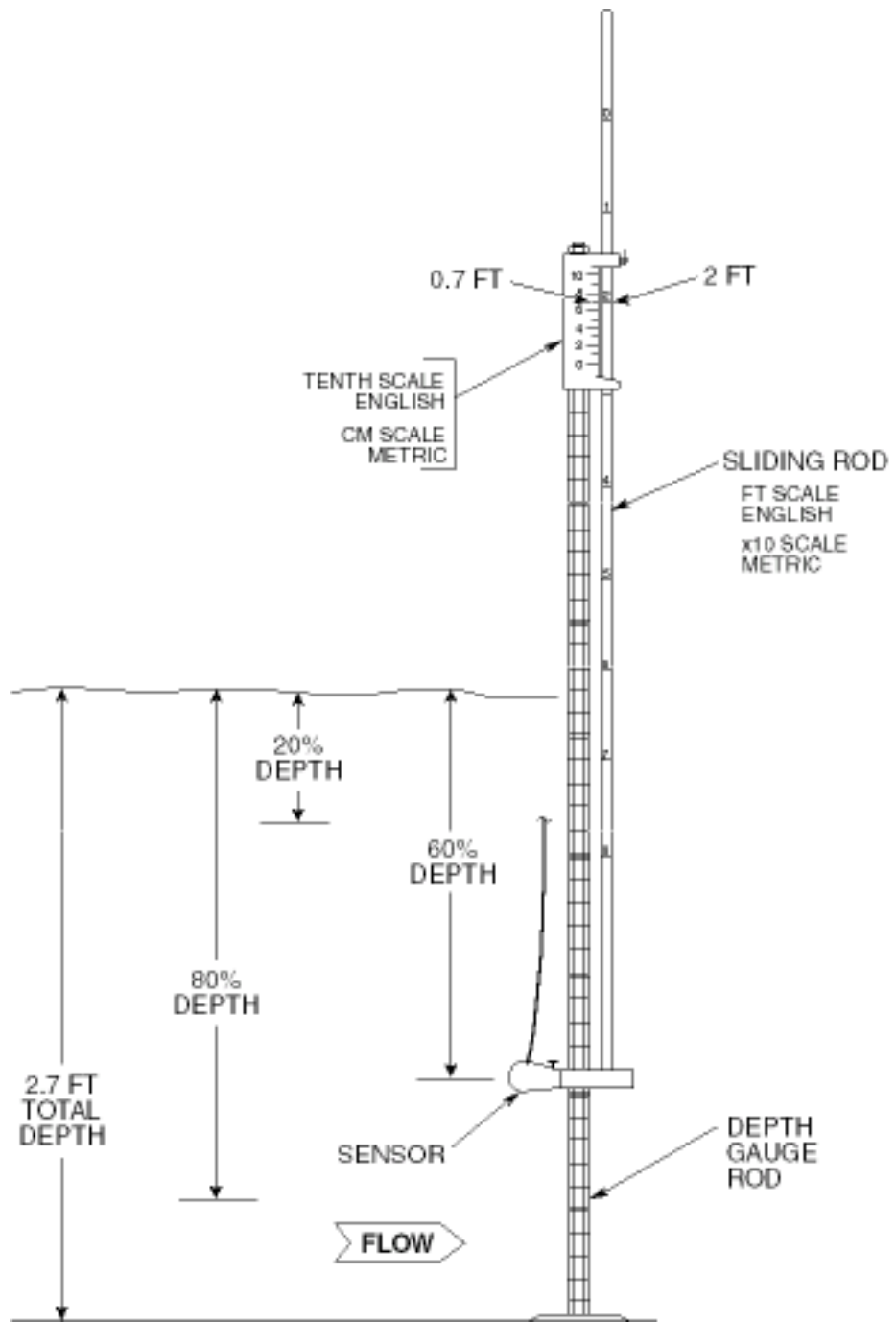

Figure 12. Top-Setting-Wading Rod

Suspension Cable

The suspension cable (Figure 13) makes it possible for the sensor to be lowered into the water from boats or bridges. To attach the sensor to the suspension cable, insert the mounting shaft on the sensor mount into the hole at the back of the sensor. The thumbscrew needs to be seated in the groove on the shaft, so make sure the shaft is completely inserted into the hole. Hand tighten the thumbscrew.

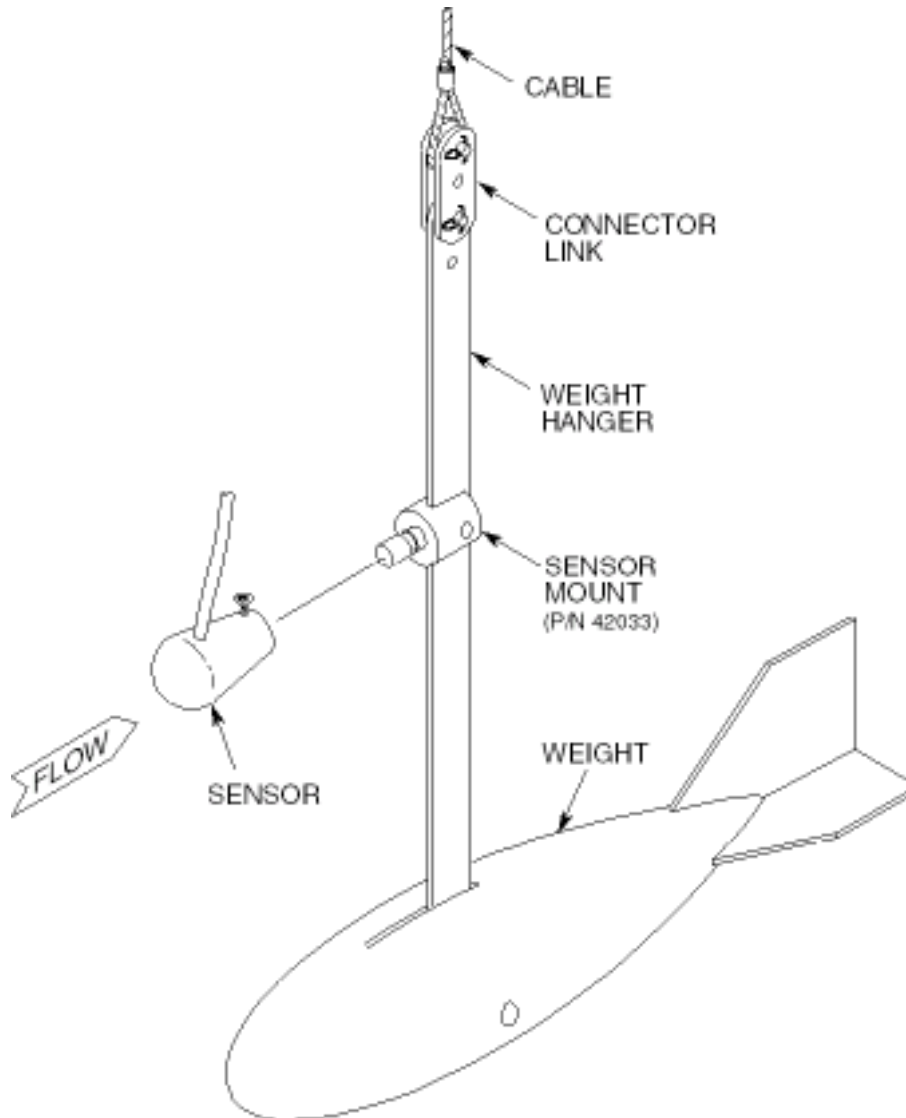

Figure 13. Suspension Cable

OPEN CHANNEL PROFILING HANDBOOK

JANUARY 1989

REV 1 MAY 1990
REV 2 JANUARY 1994

Marsh-McBirney Inc.
4539 Metropolitan Court
Frederick, Maryland 21704-9452
www.marsh-mcBirney.com
(301) 874-5599 • (800) 368-2723 • FAX (301) 874-2172

OPEN CHANNEL PROFILING

SCOPE

This handbook contains the instructions on how to measure the velocity profile and calculate the flow of open channels. The velocity profile is measured using a handheld velocity meter. Flow is calculated with the continuity equation ($Q = \bar{U} \times A$) where Q is flow, \bar{U} is mean velocity and A is cross-sectional area.

Section I describes mean velocity, cross-sectional area, site selection, profiling and methods of determining the mean velocity. Section II describes methods of calculating the instantaneous flow rate. Section III is a case study with the MMI Model 2000 being used to determine \bar{U} .

CONTENTS

SECTION I PROFILING

Mean Velocity (\bar{U}) Definition	1-1
Cross-Sectional Area	1-1
Site Selection	1-2
Choosing the Method	1-2
Profiling Checks	1-3
Calculating \bar{U}	1-3
0.9 x Vmax Method	1-3
.2 .4 .8 of Depth Method.....	1-3
.4 Method	1-4
2-D Method	1-4
2-D Method Alternate.....	1-4
VPT Method	1-5
Measuring Level	1-5
Circular Conduits.....	1-5

SECTION II CALCULATING FLOW

Circular Conduits.....	2-1
Outline	2-1
Calculate the Level/Diameter Ratio (L/D)	2-1
Identify Flow Unit Multiplier K	2-1
Square the Diameter	2-2
Calculate the Flow	2-2
Rectangular Channels	2-5
Rivers and Streams	2-6
Flow Unit Conversion	2-7

SECTION III A PROFILING EXAMPLE USING THE MMI MODEL 2000

Collecting Field Data With The Model 2000 The 2-D Method	3-1
Field Data	3-2
The .2, .4, .8 Method	3-3
The .4 Method	3-3
The 0.9 x Vmax Method.....	3-3
The VPT Method	3-3
Average \bar{U}	3-3
% OF DEVIATION	3-4
% of Deviation Between High and Average	3-4
% of Deviation Between Low and Average	3-4

SECTION I PROFILING

MEAN VELOCITY (\bar{U}) DEFINITION

A particle of water near the conduit wall will not move as fast as a particle toward the center. To understand this, we need to look at the molecules of moving liquids. The first layer of molecules stick to the wall of the conduit. The next layer will move by sliding across the first layer. This happens throughout the flow with each successive layer moving at a faster velocity. The change in velocity is greater near the conduit wall than it is toward the center. If velocity measurements of each layer could be taken, a velocity profile similar to the one in Figure 1-1 would be produced. Notice that the velocity decreases near the surface. Since most flows fit this profile, this is called the typical profile. There are, however, situations which will cause other profile shapes and it is usually more difficult to calculate flow with these shapes.

To calculate flow, an average or mean of all the varying velocities must be determined. Since it is not practical to measure the velocity of each layer of molecules, methods have been developed by which a mean velocity (\bar{U}) can be determined from velocity measurements taken at a number of positions in the flow.

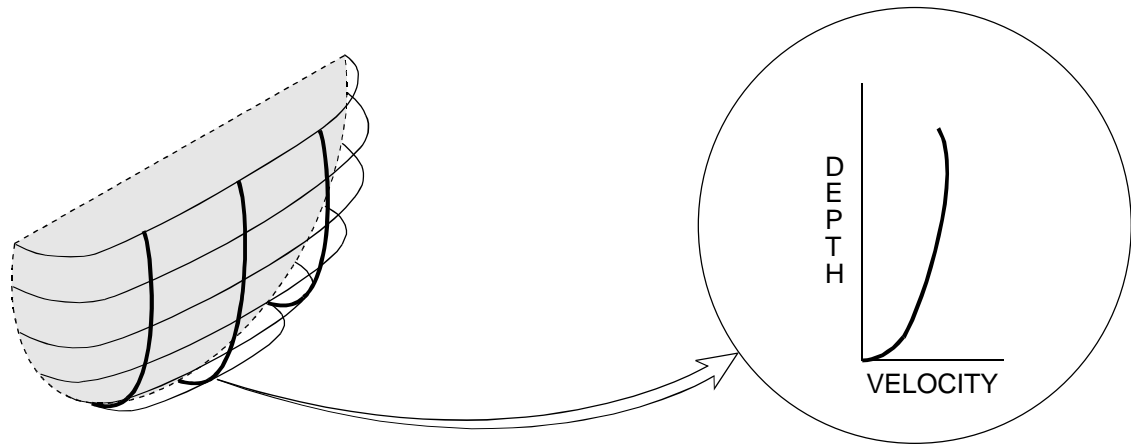

Figure 1-1. Typical Profile

CROSS-SECTIONAL AREA

The cross-sectional area of the flow is determined from a level measurement and the channel shape. It is important that the mean velocity measurement and the level measurement is done at the same location in the channel.

SITE SELECTION

A site that produces the typical profile shape will give the most accurate results. In a majority of the cases, problem sites can be identified by a visual inspection. Site inspection guidelines are as follows:

- The channel should have as much straight run as possible. Where the length of straight run is limited, the length upstream from the profile should be twice the downstream length.
- The channel should be free of flow disturbances. Look for protruding pipe joints, sudden changes in diameter, contributing sidestreams, outgoing sidestreams, or obstructions. Clean any rocks, sediment, or other debris that might be on the bottom of the pipe.
- The flow should be free of swirls, eddies, vortices, backward flow, or dead zones. Avoid areas that have visible swirls on the surface.
- Avoid areas immediately downstream from sharp bends or obstructions.
- Avoid converging or diverging flow (approach to a flume) and vertical drops.
- Avoid areas immediately downstream from a sluice gate or where the channel empties into a body of stationary water.

Choosing the Method

All profiling methods can be used in a site that produces a typical profile and has sufficient level to measure three point velocities. If you cannot avoid sites with nontypical profiles or low flows, the following guidelines will help in choosing a method that will give the best results. Keep in mind that choosing the method will become easier as you gain experience in profiling.

Low flows - The $0.9 \times U_{max}$ method is recommended in flows of less than two inches.

Rapidly Changing Flows - A flow that is changing more than 10% in three minutes or less can be classified as rapidly changing. The $0.9 \times U_{max}$ or 0.4 methods take the least amount of time. However, these methods usually require a typical profile shape for accurate results.

Comment:

Check the level several times during the profiling procedure. If the level has changed, but the change is less than 10%, average the level measurements and use the average in the flow calculation.

Asymmetrical flow - The 2-D method is recommended for asymmetrical flows. An asymmetrical flow will have a difference of 30% or more between the right and left side velocities.

Vertical drop (outfalls) - The 2-D method is recommended for outfalls. Remember to measure the level on the same plane as the velocity profile. Outfalls should be avoided wherever possible.

Nontypical profile shape - If you suspect a profile shape may not be typical, use the 2-D method.

PROFILING CHECKS

For best possible results, you should:

- Check the inside diameter of the conduit. Also, measure the horizontal and vertical diameters. If there is a difference, then average the diameters.
- Check for symmetry of flow.
- Check level several times during the procedure.
- Check the invert for rocks, sediment, and other debris.

CALCULATING \bar{U} PROFILING METHODS

0.9 x U_{max} Method

- Take a series of point velocity measurements throughout the entire flow.
- Identify the fastest velocity. In most cases, this is usually located in the center just beneath the surface.
- Multiply the fastest velocity by 0.9 for \bar{U} .

2, .4, .8 of Depth Method

- Measure depth of flow (Page 1-5).
- Calculate the positions on the centerline by:
 - 0.2 x depth
 - 0.4 x depth
 - 0.8 x depth
- At the .2, .4, and .8 positions, measure and record the velocities (Figure 1-2).

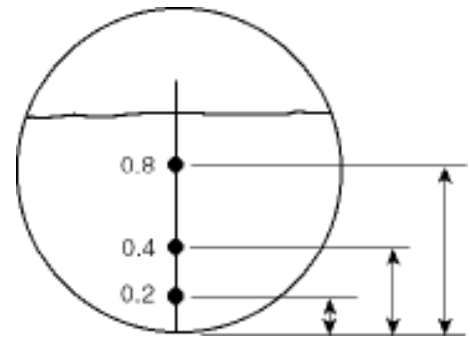

Figure 1-2. (.2, .4, .8) Velocity Positions

Comment:

In manmade channels, measure the .2, .4, and .8 positions from the bottom.

- Average .2 and .8 velocities.
- Average the .4 velocity with the .2 and .8 average for the \bar{U} .

.4 Method

A simplified version of the .2, .4, .8 method is to measure the velocity at the .4 position and use this as \bar{U} . This method is probably the least accurate because it uses only one data point and assumes that a logarithmic profile exists. This is also called the 60% of depth method.

2-D Method

- Locate the center line of the flow.
- Locate vertical velocity lines (VVL) halfway between the center line and the side walls of the conduit. This is measured at the widest part of the flow.
- Take at least seven velocity measurements at different depths along the center line.
- Take velocity readings at different depths on the VVL. The distance between these depths should be the same as those on the center line.
- Take final point velocity readings at the right and left corners of the flow.
- Check the data for any outliers. If a best fit curve of the velocity profile were plotted, an outlier would lie outside the best fit curve region. See Figure 3-1 on Page 3-2.
- Average all measurements except outliers for \bar{U} . Remember to include the corner measurements.

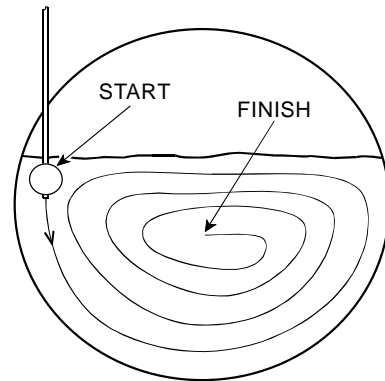

Figure 1-3. 2-D Velocity Positions

2-D Method Alternate

Another way to do the 2-D profile is with the FPA (fixed point average) feature of the Model 2000 Flo-Mate. The Flo-Mate sensor is moved at a constant velocity in a pattern across the flow that covers the cross-sectional area. The velocity displayed by the Flo-Mate at the end of the FPA period is the mean velocity.

Comment:

It may take several attempts to get the FPA time set so that the end of the FPA period coincides with the end of the sensor motion.

- Set the FPA time to the appropriate number of seconds.
- Place the sensor at the start position and wait for a few seconds.
- Press <ON/C> and start moving the sensor.

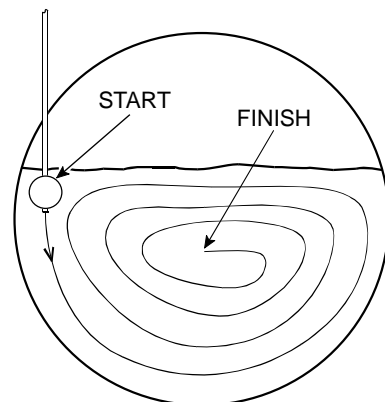

Figure 1-4. 2-D Method Alternate

VPT Method

The Velocity Profiling Technique (VPT) was first described by N. T. Debevoise and R. B. Fernandez in the November 1984 issue of the WPCF Journal. With this method, a series of point velocity measurements are taken at different depths along the centerline of the flow. These measurements along with level are input into a VPT computer program which calculates the flow. This is one example of the more advanced profile integration techniques which are possible.

MEASURING LEVEL

Circular Conduits

- Measure the inside diameter of the conduit.
- Measure distance D (Figure 1-4).
- Subtract D from the inside diameter of the conduit for the depth of flow. This eliminates the problem of the ruler interfering with the liquid.

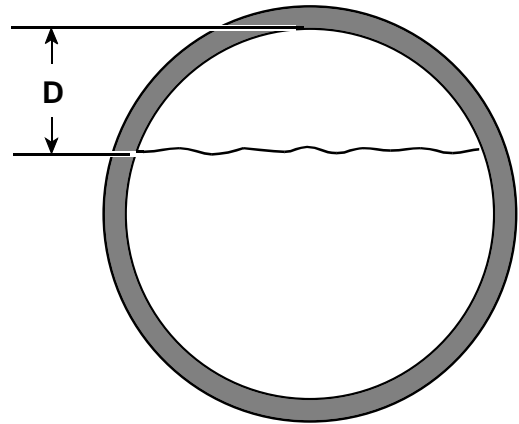

Figure 1-5. Level Measurement

Comment:

The level measurement and the velocity profile must be on the same plane for proper application of the continuity equation.

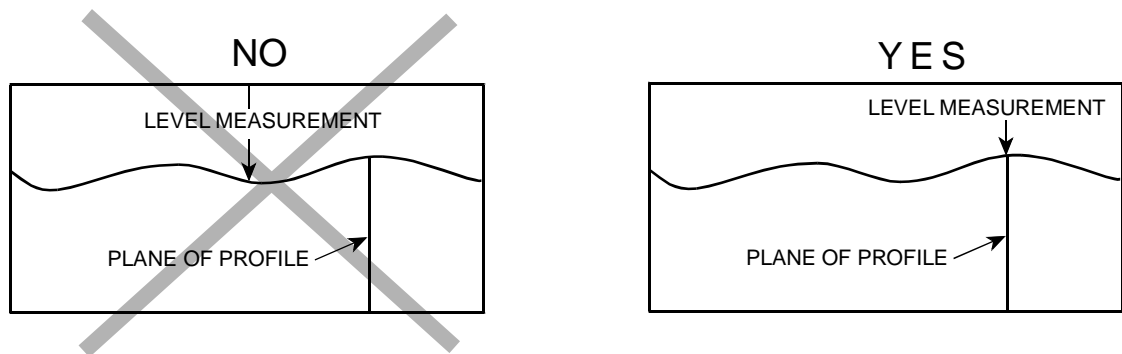

Figure 1-6. Location of Level Measurement

SECTION II CALCULATING FLOW CIRCULAR CONDUITS

To calculate flow in circular conduits you need:

- The mean velocity \bar{U} from Section I.
- The depth of flow at the time of profile.
- The inside diameter of the conduit.

Outline

Calculating flow is outlined as follows:

- Calculate the level to diameter ratio (L/D).
- Identify the flow unit multiplier (K) (Table I, Pages 2-3 and 2-4).
- Square the diameter in feet.
- Calculate flow.

Calculate the Level/Diameter Ratio (L/D)

$$\text{Ratio} = L \div D$$

Where:

L is depth of flow in inches at time of profile.

D is inside diameter in inches.

L/D is the level/diameter ratio.

Identify Flow Unit Multiplier K

K → L/D Ratio in Table I on Pages 2-3 and 2-4.

Where:

K is the flow unit multiplier.

Find the appropriate L/D ratio in the L/D column and move to the right to the desired units column to get the proper flow unit multiplier.

Comment:

The flow unit multiplier in Table I is only for circular conduits measured in feet. The multiplier was derived using a one foot per second flow in a one foot diameter conduit as the model.

Convert the Diameter to Feet and Square

$$D^2 = (\text{Diameter in inches} \div 12)^2$$

Where:

D^2 is in feet diameter squared. The diameter needs to be converted to feet because the velocity is in feet per second.

Calculate the Flow

$$K \times D^2 \times \bar{U} = \text{flow}$$

Example:

What is the flow in millions of gallons per day (MGD) of a 10-inch diameter conduit with a 6-inch level? The \bar{U} has been calculated to be 1.5 ft/sec.

Calculate Level/Diameter Ratio L/D

$$\text{Level ratio } L/D = 6 \text{ inches} / 10 \text{ inches} = 0.6$$

Identify K

$$K = 0.6 \rightarrow 0.3180 \text{ from Table I}$$

Calculate D^2

$$D^2 = (10 \text{ in} \div 12)^2 = (0.833 \text{ ft})^2 = 0.694 \text{ ft}^2$$

Calculate flow

$$K \times D^2 \times \bar{U} = \text{MGD} = 0.3180 \times 0.694 \text{ ft}^2 \times 1.5 \text{ ft/sec} = 0.331 \text{ MGD}$$

Table I Flow Unit Multiplier

L/D	K (Flow Unit Multiplier)					
	MGD	GPM	CFS	CMM	CMD	LPM
.01	.0009	.5966	.0013	.0023	3.2522	2.2585
.02	.0024	1.6824	.0037	.0063	9.1709	6.3687
.03	.0044	3.0814	.0069	.0117	16.7986	11.6644
.04	.0068	4.7296	.0105	.0179	25.7811	17.9036
.05	.0095	6.5894	.0147	.0249	35.9190	24.9438
.06	.0124	8.6351	.0192	.0327	47.0701	32.6876
.07	.0156	10.8475	.0242	.0411	59.1295	41.0621
.08	.0190	13.2113	.0294	.0500	72.0148	50.0103
.09	.0226	15.7143	.0350	.0595	85.6585	59.4851
.10	.0264	18.3460	.0409	.0694	100.0039	69.4471
.11	.0304	21.0975	.0470	.0799	115.0022	79.8627
.12	.0345	23.9609	.0534	.0907	130.6108	90.7020
.13	.0388	26.9294	.0600	.1019	146.7919	101.9388
.14	.0432	29.9967	.0668	.1135	163.5116	113.5497
.15	.0477	33.1571	.0739	.1255	180.7393	125.5134
.16	.0524	36.4056	.0811	.1378	198.4467	137.8102
.17	.0572	39.7374	.0885	.1504	216.6081	150.4223
.18	.0621	43.1480	.0961	.1633	235.1995	163.3330
.19	.0672	46.6334	.1039	.1765	254.1985	176.5267
.20	.0723	50.1898	.1118	.1900	273.5844	189.9892
.21	.0775	53.8135	.1199	.2037	293.3373	203.7064
.22	.0828	57.5012	.1281	.2177	313.4387	217.6657
.23	.0882	61.2496	.1365	.2319	333.8710	231.8548
.24	.0937	65.0555	.1449	.2463	354.6172	246.2619
.25	.0992	68.9161	.1535	.2609	375.6613	260.8759
.26	.1049	72.8286	.1623	.2757	396.9880	275.6861
.27	.1106	76.7901	.1711	.2907	418.5825	290.9823
.28	.1163	80.7982	.1800	.3059	440.4305	305.8545
.29	.1222	84.8503	.1890	.3212	462.5182	321.1932
.30	.1281	88.9439	.1982	.3367	484.8325	336.3892
.31	.1340	93.0767	.2074	.3523	507.3605	352.3337
.32	.1400	97.2464	.2167	.3681	530.0894	368.1176
.33	.1461	101.4507	.2260	.3840	553.0071	384.0327
.34	.1522	105.6875	.2355	.4001	576.1017	400.0706
.35	.1583	109.9546	.2450	.4162	599.3618	416.2234
.36	.1645	114.2500	.2545	.4325	622.7757	432.4831
.37	.1707	118.5715	.2642	.4488	646.3325	448.8419
.38	.1770	122.9172	.2739	.4653	670.0208	465.2922
.39	.1833	127.2851	.2836	.4818	693.8301	481.8265
.40	.1896	131.6733	.2934	.4984	717.7501	498.4375
.41	.1960	136.0797	.3032	.5151	741.7607	515.1178
.42	.2023	140.5026	.3130	.5319	765.8788	531.8603
.43	.2087	144.9400	.3229	.5487	790.0673	548.6578
.44	.2151	149.3902	.3328	.5655	814.3250	565.5034
.45	.2215	153.8512	.3428	.5824	838.6420	582.3902
.46	.2280	158.3212	.3527	.5993	863.0080	599.3111
.47	.2344	162.7985	.3627	.6163	887.4133	616.2592
.48	.2409	167.2811	.3727	.6332	911.8480	633.2277
.49	.2473	171.7673	.3827	.6502	936.3024	650.2100
.50	.2538	176.2553	.3927	.6672	960.7664	667.1989

Table I Continued

L/D	K (Flow Unit Multiplier)					
	MGD	GPM	CFS	CMM	CMD	LPM
.51	.2603	180.7433	.4027	.6842	985.2306	684.1879
.52	.2667	185.2295	.4127	.7012	1009.6850	701.1701
.53	.2732	189.7121	.4227	.7181	1043.1200	718.1385
.54	.2796	194.1894	.4327	.7351	1058.5250	735.0869
.55	.2861	198.6594	.4426	.7520	1082.8910	752.0076
.56	.2925	203.1204	.4526	.7689	1107.1080	768.8945
.57	.2989	207.5706	.4635	.7857	1131.4660	785.7401
.58	.3053	212.0080	.4724	.8025	1155.6540	802.5377
.59	.3117	216.4309	.4822	.8193	1179.7630	819.2801
.60	.3180	220.8374	.4920	.8360	1203.7830	835.9605
.61	.3243	225.2255	.5018	.8526	1227.7030	852.5715
.62	.3306	229.5934	.5115	.8691	1251.5120	869.1057
.63	.3369	233.9392	.5212	.8856	1275.2010	885.5560
.64	.3431	238.2607	.5308	.9019	1298.7580	901.9149
.65	.3493	242.5560	.5404	.9182	1322.1710	918.1745
.66	.3554	246.8232	.5499	.9343	1345.4320	934.3275
.67	.3615	251.0600	.5594	.9504	1368.5260	950.3654
.68	.3676	255.2643	.5687	.9663	1391.4440	966.2805
.69	.3736	259.4340	.5780	.9821	1414.1730	982.0645
.70	.3795	263.5668	.5872	.9977	1436.7010	997.7090
.71	.3854	267.6604	.5963	1.0132	1459.0150	1013.2050
.72	.3913	271.7125	.6054	1.0285	1481.1030	1028.5440
.73	.3970	275.7206	.6143	1.0437	1502.9510	1043.7160
.74	.4027	279.6822	.6231	1.0579	1524.5460	1058.7120
.75	.4084	283.5946	.6319	1.0735	1545.8720	1073.5220
.76	.4139	287.4553	.6405	1.0881	1566.9170	1088.1370
.77	.4194	291.2612	.6489	1.1025	1587.6630	1102.5440
.78	.4248	295.0096	.6573	1.1167	1608.0950	1116.7330
.79	.4301	298.6972	.6655	1.1307	1628.1970	1130.6920
.80	.4353	302.3210	.6736	1.1444	1647.9500	1144.4090
.81	.4405	305.8774	.6815	1.1579	1667.3360	1157.8720
.82	.4455	309.3629	.6893	1.1711	1686.3350	1171.0660
.83	.4505	312.7735	.6969	1.1840	1704.9260	1183.9760
.84	.4552	316.1053	.7043	1.1966	1723.0880	1196.5890
.85	.4599	319.3538	.7115	1.2089	1740.7950	1208.8860
.86	.4644	322.5143	.7186	1.2208	1758.0230	1220.8490
.87	.4688	325.5815	.7254	1.2325	1774.7430	1232.4600
.88	.4731	328.5500	.7320	1.2437	1790.9240	1243.6970
.89	.4772	331.4135	.7384	1.2545	1806.5330	1254.5360
.90	.4812	334.1650	.7445	1.2650	1821.5310	1264.9520
.91	.4850	336.7967	.7504	1.2749	1835.8760	1274.9140
.92	.4886	339.2997	.7560	1.2844	1849.5200	1284.3890
.93	.4920	341.6636	.7612	1.2933	1862.4060	1293.3370
.94	.4952	343.8759	.7662	1.3017	1874.4650	1301.7120
.95	.4981	345.9216	.7707	1.3095	1885.6160	1309.4560
.96	.5008	347.7815	.7749	1.3165	1895.7540	1316.4960
.97	.5032	349.4297	.7785	1.3277	1904.7390	1322.7350
.98	.5052	350.8287	.7816	1.3280	1912.3650	1328.0310
.99	.5068	351.9145	.7841	1.3321	1918.2840	1332.1410
1.00	.5076	352.5112	.7854	1.3344	1921.5360	1334.4000

RECTANGULAR CHANNELS

Flow in rectangular channels is calculated by the following:

- Determine \bar{U} with the .2, .4, .8 method as described on Page 1-3. For channel widths of six feet or larger, use the .2, .6, .8 method as described on Page 2-6 for rivers and streams. Velocity units must be in ft/sec.
- Calculate the cross-sectional area in ft² by:

$$[(\text{Depth of Flow}) \text{ in.} \div 12] \times [(\text{Channel Width}) \text{ in.} \div 12]$$
- Calculate flow by:

$$\bar{U} \times (\text{Cross-sectional Area})$$

The result should be a flow rate in ft³/sec (CFS). You can convert this to other flow units with the flow unit conversion multipliers in Table III on page 2-7.

Example:

What is the flow in a channel 24 inches wide with a 10-inch deep flow?

Solution:

- Velocity measured at
 - .2 = 1.5 ft/sec
 - .4 = 1.7 ft/sec
 - .8 = 1.8 ft/sec
- $(1.5 + 1.8) \div 2 = 1.65 \text{ ft/sec}$
- $\bar{U} = (1.65 + 1.7) \div 2 = 1.67 \text{ ft/sec}$
- From Table II on Page 2-5, 10 in = 0.83 ft
- Area = 0.83 ft x 2 ft = 1.66 ft²
- Flow = 1.67 ft²/sec x 1.66 ft = 2.77 ft³/sec

From Table III on Page 2-7.

$$.64632 \times 2.77 \text{ ft}^3/\text{sec} = 1.7903 \text{ MGD}$$

Table II Inch to Feet Conversion

IN	0.50	1.00	1.50	2.00	2.50	3.00	3.50	4.00
FT	0.04	0.08	0.13	0.17	0.21	0.25	0.29	0.33
IN	4.50	5.00	5.50	6.00	6.50	7.00	7.50	8.00
FT	0.37	0.42	0.46	0.50	0.54	0.58	0.62	0.67
IN	8.50	9.00	9.50	10.00	10.50	11.00	11.50	12.00
FT	0.71	0.75	0.79	0.83	0.87	0.92	0.96	1.00

RIVERS AND STREAMS

You will need to divide the width of the channel into equal segments (Figure 2-1). Then do a velocity profile and calculate the flow for each segment. Sum the segment flows for the total flow. The procedure for calculating flows in rivers and streams is as follows:

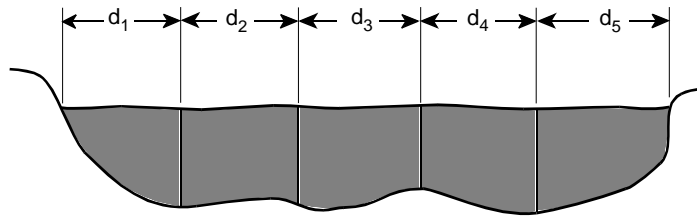

Figure 2-1. Segment Length

Comment:

The smaller the segment the better the result. If you find that the difference in mean velocity between two adjacent segments is greater than 10%, the segments should be smaller.

- Divide the channel width into segments of equal length (d) (Figure 2-1).
- Locate the center line of each segment at $\frac{1}{2}d$ (Figure 2-2).
- Measure segment depth on the segment center line.

Comment:

The .2, .6, and .8 positions for rivers and streams are measured from the surface. All depth and velocity measurements must be on the same plane.

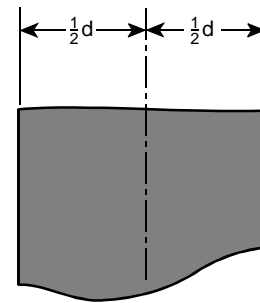

Figure 2-2. Segment Centerline

- Calculate the .2, .6, .8 velocity positions on the segment centerline by:

.2 x Depth

.6 x Depth

.8 x Depth

- Measure the velocity at the .2, .6, and .8 positions.
- Average the .2 and .8 velocities.
- Average the .6 velocity with the average of the .2 and .8 velocities for \bar{U} .
- Calculate segment areas (Figure 2-4).
- Calculate the flow of each segment by:
Segment Area x \bar{U} .
- Sum the flow of the segments for total flow.

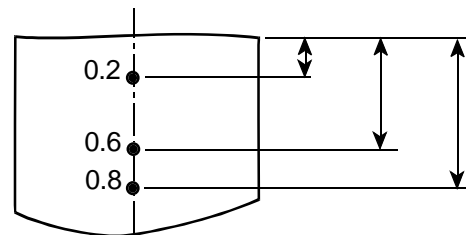

Figure 2-3. Velocity Profile

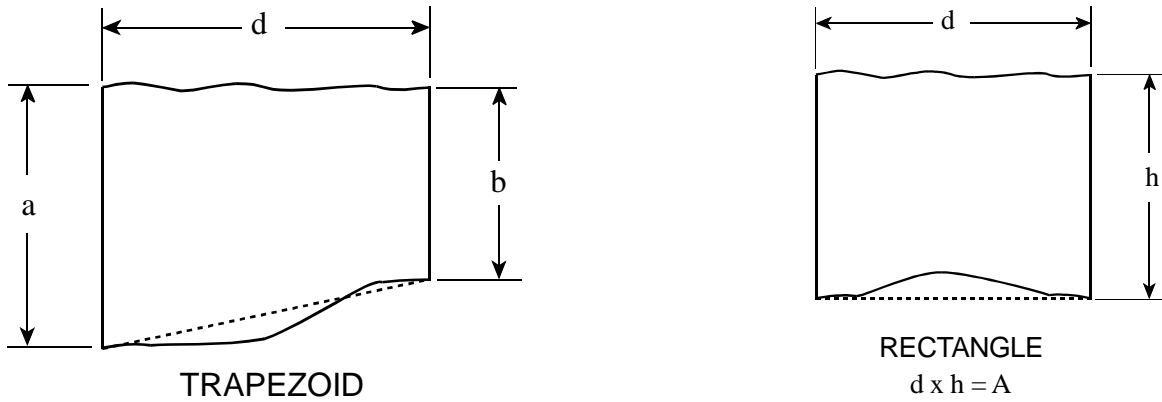

Figure 2-4. Segment Area

Flow Unit Conversion

To convert flow units, locate the appropriate flow unit conversion factor in Table III. Then multiply the existing unit's conversion factor to get the new unit's.

Table III Flow Unit Conversion Factors

		NEW UNITS				
		CFS	MGD	GPM	CMD	CMM
EXISTING UNITS	CFS	1	0.64632	448.831	2446.576	1.69901
	MGD	1.54723	1	694.44	3785.412	2.62876
	GPM	0.002228	0.00144	1	5.45099	0.0037854
	CMD	0.000408	0.0002642	0.18345	1	0.0006944
	CMM	0.5885	0.380408	264.172	1440	1

Example:

Convert 20 ft³/sec (CFS) to millions of gallons per day (MGD).

Solution:

From: Table III, conversion factor = 0.64632

Then: 20 ft³/sec x 0.64632 = 12.9264 MGD

Table IV Flow Units

MGD - Millions of Gallons per Day	CMM - Cubic Meters per Minute
GPM - Gallons per Minute	CMD - Cubic Meters per Day
CFS - Cubic Feet per Second	LPM - Liters per Minute

SECTION III

A PROFILING EXAMPLE

USING THE MMI MODEL 2000

This section illustrates how to collect and analyze data from circular conduits and achieve the best possible accuracy. The data shown in this section is actual field data that was collected with a MMI Model 2000 in a normal flow.

Comment:

A 2-D profile is used to collect the field data since this method provides the most point velocity measurements. A centerline profile is plotted and a best fit curve is drawn. This permits all profiling methods described in Section I to be utilized with one set of velocity measurements.

Collecting Field Data With the Model 2000

The 2-D Method

We start the 2-D profile on the vertical center line at the invert or bottom of the conduit. The first velocity measurement with the Model 2000 is at 0.75 inches or 1.9 cm from the invert. This is because the electrodes, which measure the point velocity, are 0.75 inches from the bottom of the sensor. If the sensor is moved up 0.25 inches for the second velocity measurement, this will put the electrodes one inch from the invert. The sensor can then be moved at even-inch or half-inch increments. Five to ten velocity measurements between the bottom and the surface are recommended. After the vertical center line is profiled, the level is measured and recorded.

Next the right and left vertical velocity lines are profiled and recorded. Then the right and left corner velocity measurements are taken and recorded. Finally the level is measured and recorded. We now have the necessary data to calculate flow.

Comment:

If there is a sudden drop in velocity at any position, check the sensor for debris.

FIELD DATA

CONDUIT DIAMETER = 24.25 INCHES

POSITION AS MEASURED FROM THE INVERT	CENTERLINE FT/SEC	RIGHT VVL FT/SEC	LEFT VVL FT/SEC
0.75	5.2	5.2	4.9
1.0	5.4	5.5	5.2
2.0	5.4	5.5	5.5
3.0	4.3	5.5	5.5
4.0	5.5	5.1	5.2
5.0	5.4	4.2	4.8
6.0	5.2	4.0	4.2
6.5	4.0		

LEVEL DURING PROFILE	AVERAGE LEVEL	RIGHT CORNER VEL	LEFT CORNER VEL
7 INCHES			
6 ⁷ / ₈ INCHES	7 INCHES	4.0 FT/SEC	4.8 FT/SEC
7 ¹ / ₈ INCHES			

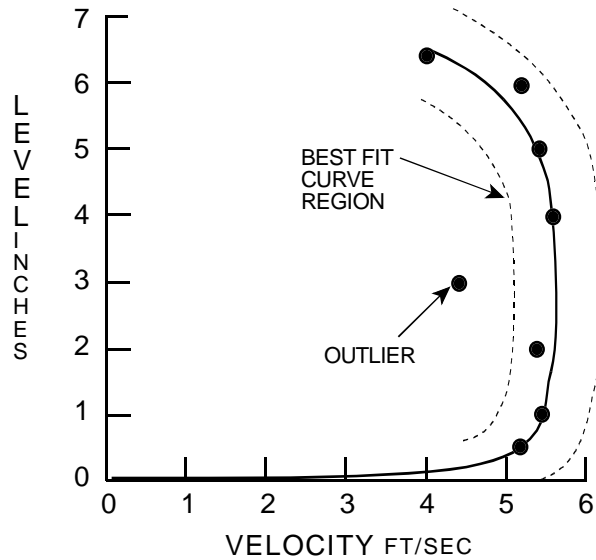

Figure 3-1. Best Fit Curve

Comment:

The 4.3 ft/sec velocity at the 3-inch position is outside the best fit curve region and is ignored. This is called an outlier

The .2, .4, .8 Method

POSITION	VELOCITY
.2 x 7" = 1.4"	5.4 ft/sec
.4 x 7" = 2.8"	5.5 ft/sec
.8 x 7" = 5.35"	5.35 ft/sec

$(5.4 + 5.35) \div 2 = 5.37$ ft/sec
 $\bar{U} = (5.37 + 5.5) \div 2 = 5.44$ ft/sec

The .4 Method

The velocity at the .4 position = 5.5 ft/sec.
 $\bar{U} = 5.5$ ft/sec.

The 0.9 x Vmax Method

$V_{max} = 5.5$ ft/sec.
 $\bar{U} = 0.9 \times 5.5 = 4.95$ ft/sec

The 2-D Method

Average all velocity measurements. Remember to include the two corner measurements and discard any outliers.

$$\bar{U} = 4.8 \text{ ft/sec}$$

The VPT Method

This method requires a computer program. If you have this program, enter the velocity measurements from the center line profile. Discard any outliers.

$$\bar{U} \text{ from VPT program} = 5.32 \text{ ft/sec}$$

Average \bar{U}

An overall \bar{U} can be calculated by averaging the values from the different methods.

$$(5.44 + 5.5 + 4.95 + 5.0 + 5.32) \div 5 = 5.24 \text{ ft/sec}$$

Comment:

If the profile is not symmetrical, then the results from the .9 x Vmax and 2-D methods may vary greatly from the VPT; .2, .4, .8; and .4 methods.

% OF DEVIATION

We calculate the % of deviation between the average and high \bar{U} , and the average and low \bar{U} . We discard any \bar{U} that has a deviation greater than 10% from the average \bar{U} .

% of Deviation Between High \bar{U} (5.5 ft/sec) and Average \bar{U}

$$\% \text{ deviation} = \frac{(5.5 - 5.2)}{5.24} \times 100 = 5.7\%$$

% of Deviation Between Low \bar{U} (4.8 ft/sec) and Average \bar{U}

$$\% \text{ deviation} = \frac{(5.2 - 4.8)}{5.2} \times 100 = 7.7\%$$

Since the no deviation is greater than 10% from the average \bar{U} , all the values are useable.